

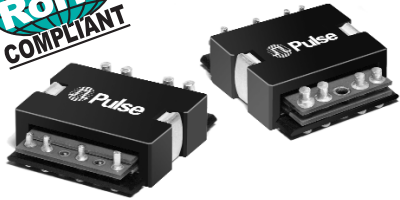





HIGH FREQUENCY PLANAR TRANSFORMERS

PA09XXNL Series (up to 250W)



-  **Power Rating:** up to 250W
-  **Height:** 9.1mm to 10.4mm Max
-  **Footprint:** 29.5mm x 26.7mm Max
-  **Frequency Range:** 200kHz to 700kHz
-  **Isolation (Primary to Secondary):** 1750V_{DC}

Electrical Specifications @ 25°C — Operating Temperature -40°C to +125°C

Part Number	Turns Ratio		Schematic	Primary* Inductance (μH MIN)	Leakage** Inductance (μH MAX)	DCR (mΩ MAX)				Maximum Height (mm)
	Primary	Secondary				Primary A	Primary B	Primary Aux.	Secondary	
DOUBLE INTERLEAVE DESIGNS (HIGHER EFFICIENCY, LOWER DCR AND LOWER LEAKAGE)										
PA0901NL	4T & 4T	4T (1T:1T:1T:1T)	A1	216	0.3	12	12	—	4.5	10.2
PA0903NL	5T & 5T (w/5T aux)			340	0.3	15	15	235		
PA0905NL	6T & 6T (w/2T aux)			480	0.3	21	21	78		
PA0907	7T & 7T (w/3T aux)			660	0.3	50	50	100		
PA0909NL	8T & 8T			860	0.3	60	60	—		
PA0908NL	4T & 4T	1T & 1T	A2	216	0.3	12	12	—	0.56 & 0.56	10.2
PA0910NL	5T & 5T (w/5T aux)			340	0.3	15	15	235		
PA0912NL	6T & 6T (w/2T aux)			480	0.3	21	21	78		
PA0914NL	7T & 7T (w/3T aux)			660	0.3	50	50	100		
PA0916	8T & 8T			860	0.3	60	60	—		
SINGLE INTERLEAVE DESIGNS (LOWER COST)										
PA0930	4T	4T (1T:1T:1T:1T)	B1	54	0.3	12	—	—	4.5	9.1
PA0931NL	5T (w/5T aux)			85	0.3	15	—	470		
PA0932	6T (w/2T aux)			120	0.3	21	—	156		
PA0933	7T (w/3T aux)			165	0.3	50	—	200		
PA0946	8T			215	0.3	60	—	—		
PA0934	4T	7T & 7T	B2	54	0.3	12	—	—	40 & 40	9.1
PA0935	5T (w/5T aux)			85	0.3	15	—	470		
PA0936	6T (w/2T aux)			120	0.3	21	—	156		
PA0937	7T (w/3T aux)			165	0.3	50	—	200		
PA0947NL	8T			215	0.3	60	—	—		
PA0938	4T	1T & 1T	B2	54	0.3	12	—	—	1.12 & 1.12	9.1
PA0939	5T (w/5T aux)			85	0.3	15	—	470		
PA0940	6T (w/2T aux)			120	0.3	21	—	156		
PA0941	7T (w/3T aux)			165	0.3	50	—	200		
PA0948	8T			215	0.3	60	—	—		
PA0942	4T	2T & 1T	B3	54	0.3	12	—	—	1.8 & 0.6	9.1
PA0943NL	5T (w/5T aux)			85	0.3	15	—	470		
PA0944	6T (w/2T aux)			120	0.3	21	—	156		
PA0945	7T (w/3T aux)			165	0.3	50	—	200		
PA0949	8T			215	0.3	60	—	—		

Notes: *Inductance is measured, where applicable, with both primary windings connected in series (2 to 5, with 3 and 4 shorted).
 **Leakage inductance is measured with both primary windings connected in series (where applicable) with all other windings shorted.

USA 858 674 8100 • Germany 49 7032 7806 0 • Singapore 65 6287 8998 • Shanghai 86 21 54643211 / 2 • China 86 755 33966678 • Taiwan 886 3 4641811

HIGH FREQUENCY PLANAR TRANSFORMERS

PA09XXNL Series (up to 250W)



Mechanical

Weight19.8 grams
 Tray30/tray
 Dimensions: $\frac{\text{Inches}}{\text{mm}}$
 Unless otherwise specified, all tolerances are $\pm \frac{.010}{0,25}$

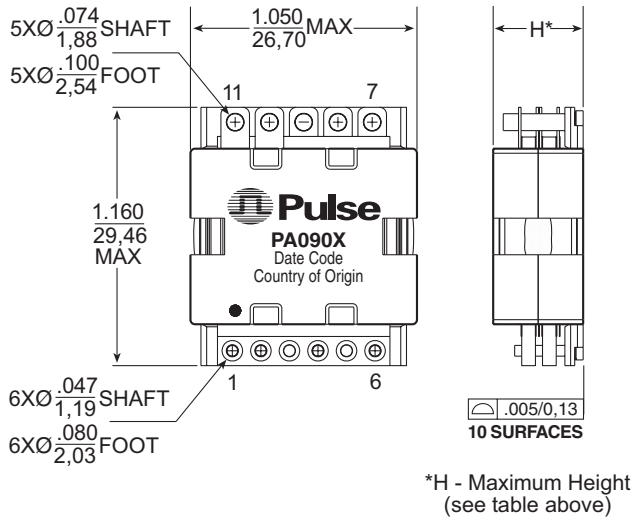

SUGGESTED PAD LAYOUT

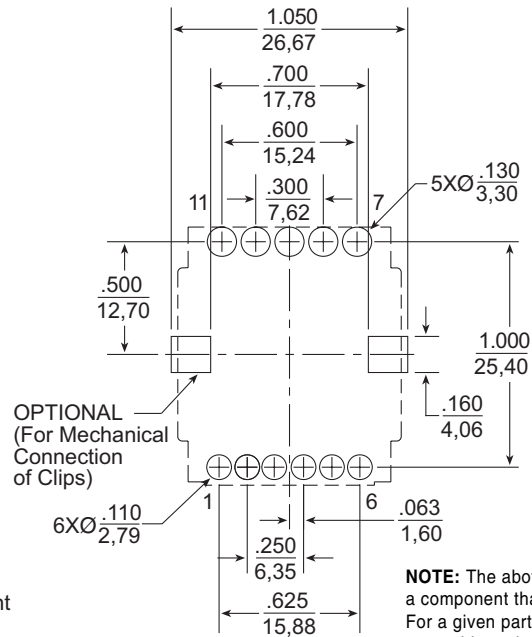

NOTE: The above is a universal footprint for a component that has all 11 pins populated. For a given part number it is only necessary to provide pads for the terminations shown in the schematic below.

Schematics

— DOUBLE INTERLEAVE SCHEMATICS —

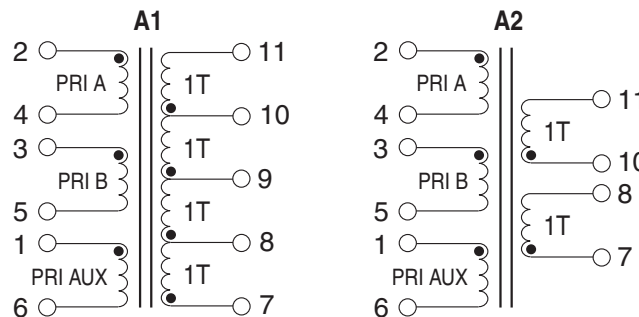

— SINGLE INTERLEAVE SCHEMATICS —

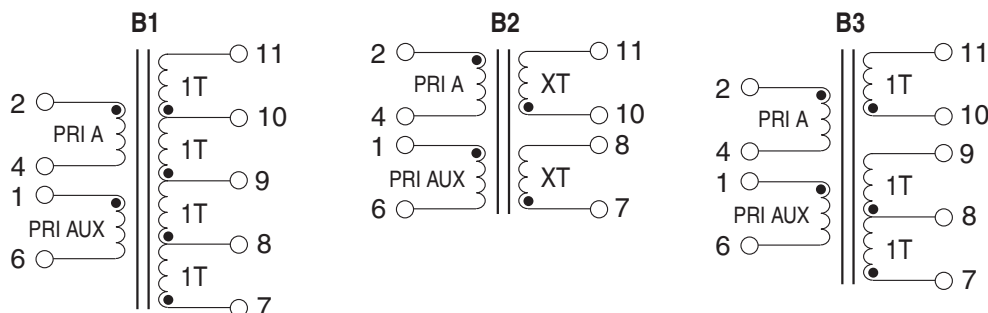

HIGH FREQUENCY PLANAR TRANSFORMERS

PA09XXNL Series (up to 250W)



PA09XX Transformer Winding Configuration Matrix

The following is a matrix of the winding configurations that are possible with the Pulse PA090X Planar Transformer Platform. The package is typically capable of handling between 150-250W of power depending on the application, ambient conditions and

available cooling. Once a configuration is selected, the formulae and charts can be used to determine the approximate power dissipation and temperature rise of the component in a given application.

High Efficiency Double Interleaved Designs										
			SECONDARY WINDINGS							
			Single Winding			Tapped Winding			Dual Winding	
			Turns	1T	2T	4T	1:1	1:3	2:2	1T & 1T
		DCR (mΩ)	0.28	1.12	4.5	1.12	4.5	4.5	1.12	
PRIMARY WINDINGS	Single Winding	4T	5	PA0908	PA0908	PA0901	PA0908	PA0901	PA0901	PA0908
		5T	7.5	PA0910	PA0910	PA0903	PA0910	PA0903	PA0903	PA0910
		6T	12	PA0912	PA0912	PA0905	PA0912	PA0905	PA0905	PA0912
		7T	30	PA0914	PA0914	PA0907	PA0914	PA0907	PA0907	PA0914
		8T	20	PA0908	PA0908	PA0901	PA0908	PA0901	PA0901	PA0908
		10T	30	PA0910	PA0910	PA0903	PA0910	PA0903	PA0903	PA0910
		12T	48	PA0912	PA0912	PA0905	PA0912	PA0905	PA0905	PA0912
		14T	120	PA0914	PA0914	PA0907	PA0914	PA0907	PA0907	PA0914
	16T	140	PA0916	PA0916	PA0909	PA0916	PA0909	PA0909	PA0916	
	Dual Winding	4T & 4T	20	PA0908	PA0908	PA0901	PA0908	PA0901	PA0901	PA0908
		5T & 5T	30	PA0910	PA0910	PA0903	PA0910	PA0903	PA0903	PA0910
		6T & 6T	48	PA0912	PA0912	PA0905	PA0912	PA0905	PA0905	PA0912
		7T & 7T	120	PA0914	PA0914	PA0907	PA0914	PA0907	PA0907	PA0914
		8T & 8T	140	PA0916	PA0916	PA0909	PA0916	PA0909	PA0909	PA0916

Lower Cost Single Interleaved Designs																
			SECONDARY WINDINGS													
			Single Winding					Tapped Winding					Dual Winding			
			Turns	1T	2T	3T	4T	7T	1:1	1:2	1:3	2:2	7:7	1T & 1T	1T & 2T	7T & 7T
		DCR (mΩ)	0.56	2.24	3.4	4.5	20	2.24	3.4	4.5	4.5	80	2.24	4.5	80	
PRIMARY WINDINGS	Single Winding	4T	10	PA0938	PA0938	PA0942	PA0930	PA0934	PA0938	PA0942	PA0930	PA0930	PA0934	PA0938	PA0942	PA0934
		5T	15	PA0939	PA0939	PA0943	PA0931	PA0935	PA0939	PA0943	PA0931	PA0931	PA0935	PA0939	PA0943	PA0935
		6T	24	PA0940	PA0940	PA0944	PA0932	PA0936	PA0940	PA0944	PA0932	PA0932	PA0936	PA0940	PA0944	PA0936
		7T	60	PA0941	PA0941	PA0945	PA0933	PA0937	PA0941	PA0945	PA0933	PA0933	PA0937	PA0941	PA0945	PA0937
		8T	70	PA0948	PA0948	PA0949	PA0946	PA0947	PA0948	PA0949	PA0946	PA0946	PA0947	PA0948	PA0947	PA0947

NOTES:

- The base PN (ie: **PA0901**) uses an ungapped core. The minimum primary inductance for any configuration can be calculated as:

$$\text{Primary Inductance } (\mu\text{H Min}) = 3.4 * (\text{Primary Turns})^2$$
- The above base part numbers (**PA09XX**) are available from stock
- It is possible to add a small gap to the transformer. Gapped transformers are non-standard and can be made available upon request, but are not typically available from stock. To request a gapped version of the transformer, add a suffix "G" to the base number (ie: PA0901NLG). The nominal inductance with a gap can be calculated as:
$$\text{Primary Inductance } (\mu\text{H Nominal}) = 2.2 * (\text{Primary Turns})^2$$

HIGH FREQUENCY PLANAR TRANSFORMERS

PA09XXNL Series (up to 250W)



Notes from Tables

1. The above transformers have been tested and approved by Pulse's IC partners and are cited in the appropriate datasheet or evaluation board documentation at these companies. To determine which IC and IC companies are matched with the above transformers, please refer to the IC cross reference on the Pulse web page.
2. To determine if the transformer is suitable for your application, it is necessary to ensure that the temperature rise of the component (ambient plus temperature rise) does not exceed its operating temperature. To determine the approximate temperature rise of the transformer, refer to the graphs below.
3. The "NL" suffix indicates an RoHS-compliant part number. Non-NL suffixed parts are not necessarily RoHS compliant, but are electrically and mechanically equivalent to NL versions. If a part number does not have the "NL" suffix, but an RoHS compliant version is required, please contact Pulse for availability.

Core Loss vs. Flux Density

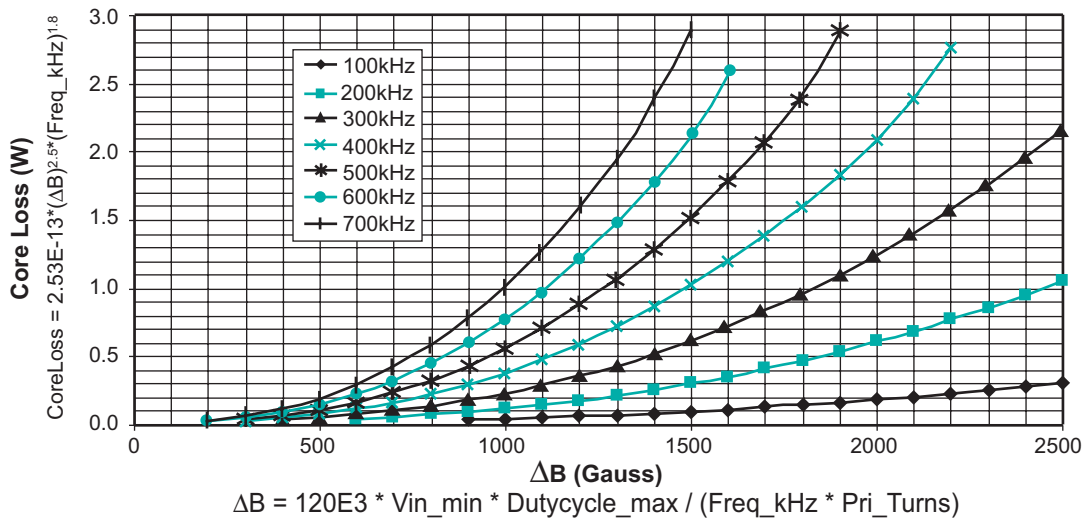

Temperature Rise vs. Power (W) Dissipation

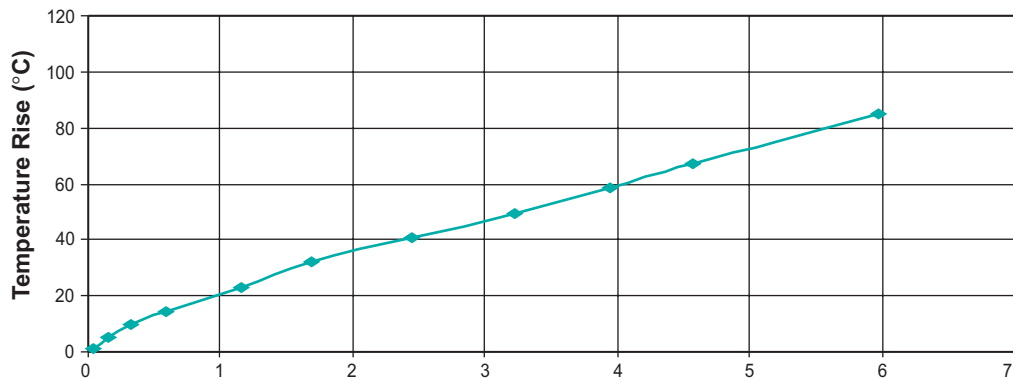

Total Power Dissipation (W) = $.001 * (DCR_{primary} * I_{RMS_primary}^2 + DCR_{secondary} * I_{RMS_secondary}^2) + Core Loss (W)$