

FEATURES

- SUPER MINIATURE SIZE AND LOW PROFILE
- HIGH DENSITY PACKAGING OFFERS SIGNIFICANT SPACE SAVINGS
- LOWER PRODUCTION COSTS WITH LESS PLACEMENT (UP TO 8 RESISTORS IN ONE PACKAGE)
- STANDARD FOOTPRINTS MAKE CONVERSIONS EASY
- BOTH FLOW AND REFLOW SOLDERING APPLICABLE

**RoHS
Compliant**

includes all homogeneous materials

*See Part Number System for Details

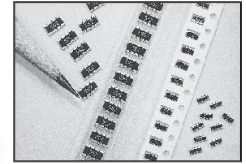

SPECIFICATIONS

Type	NRSNA4I2	NRSNØ4I4	NRSNA4I4	NRSNA6I4	NRSNØ6I4	NRSNØ6C NRSNØ6D	NRSN12I4
Termination Type	Convex	Concave	Convex	Convex	Concave	Concave	Concave
Size W x L (mm)	1.0 x 1.0	1.0 x 2.0	1.0 x 2.0	1.6 x 3.2		3.1 x 6.4	3.0 x 5.1
No. of Resistors & Circuit	2R Isolated	4R Isolated	4R Isolated	4R Isolated		8R Common	4R Isolated
Power Rating per Resistor @ +70°C	1/16 (.0625W)	1/16 (.0625W)	1/16 (.0625W)	1/16 (.0625W)		1/8 (.125W)	
Resistance Tolerance	J(±5%), G(±2%)	J(±5%), G(±2%)	J(±5%), G(±2%)	J(5%), G(2%)		J (5%)	J (5%) G (2%)
Resistance Range	10Ω ~ 1MΩ	10Ω ~ 1MΩ	10Ω ~ 1MΩ	10Ω ~ 1MΩ		100Ω ~ 470KΩ	10Ω ~ 1MΩ 47Ω ~ 1MΩ
Temperature Coefficient	±250ppm	±200ppm	±200ppm	±200ppm		±200ppm	±200ppm ±200ppm
Maximum Working Voltage*	25V			50V		75V	
Maximum Overload Voltage	50V			100V		125V	
Operating Temperature Range	-55°C ~ +125°C (derated as shown)						

* Maximum allowable continuous voltage for all resistors is the lower of the two values: "MAXIMUM WORKING VOLTAGE" as specified, or $\sqrt{\text{Power rating (WATTS)} \times \text{Resistance (OHMS)}}$

Power Derating Curve: For operation above 70°C, power rating must be derated according to the following chart:

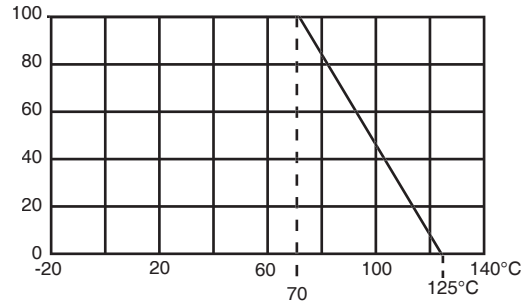

PART NUMBER SYSTEM (E-24 VALUES)

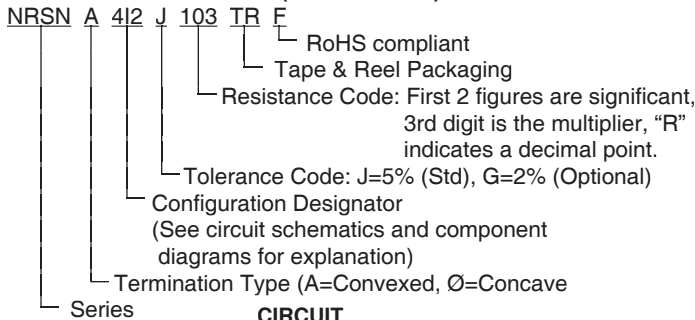

CIRCUIT SCHEMATICS

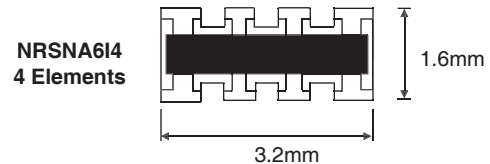
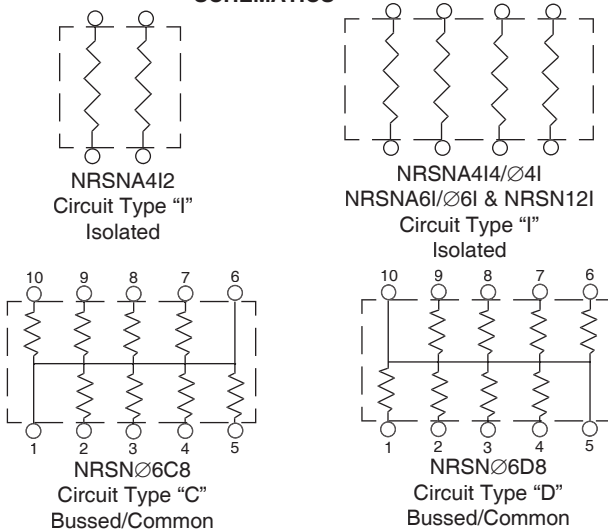

Note 1:

Zero ohm versions (R<0.050 ohms) are available in the following parts:
 NRSNA4I2ZOTR - 0.5A/element (no markings)
 NRSNØ4I4ZOTR - 0.5A/element (marked "R00")
 NRSNA4I4ZOTR - 0.5A/element (marked "R00")
 NRSNØ6I4ZOTR - 1.0A/element (marked "000")
 NRSNA6I4ZOTR - 1.0A/element (marked "R00")
 NRSN12I4ZOTR - 1.5A/element (marked "000")



PART DIMENSIONS (mm)

Type	W	L	P	T	A	B	C
NRSNA4I2	1.00 ± 0.20	1.00 ± 0.10	0.67 nom.	0.30 ± 0.05	0.33 ± 0.10	0.15 ± 0.10	0.25 ± 0.10
NRSNA4I4	1.00 ± 0.20	2.00 ± 0.10	0.50 nom.	0.40 ± 0.10	0.30 ± 0.10	0.20 ± 0.10	0.25 ± 0.10
NRSNØ4I4	1.00 ± 0.20	2.00 ± 0.10	0.50 nom.	0.40 ± 0.10	0.30 ± 0.10	0.15 ± 0.10	0.25 ± 0.10
NRSNA6I4	1.60 ± 0.15	3.20 ± 0.20	0.80 nom.	0.50 ± 0.10	0.50 ± 0.10	0.30 ± 0.15	0.30 ± 0.15
NRSNØ6I4	1.60 ± 0.15	3.20 ± 0.20	0.80 nom.	0.55 ± 0.10	0.50 ± 0.10	0.35 ± 0.15	0.45 ± 0.15
NRSNØ6C8	3.10 ± 0.20	6.40 ± 0.20	1.27 ± 0.20	0.60 ± 0.20	1.00 ± 0.20	0.55 ± 0.20	0.50 ± 0.20
NRSNØ6D8	3.10 ± 0.20	6.40 ± 0.20	1.27 ± 0.20	0.60 ± 0.20	1.00 ± 0.20	0.55 ± 0.20	0.50 ± 0.20
NRSN12I4	3.00 ± 0.20	5.08 ± 0.20	1.27 ± 0.20	0.70 ± 0.20	0.80 ± 0.20	0.60 ± 0.20	0.60 ± 0.20

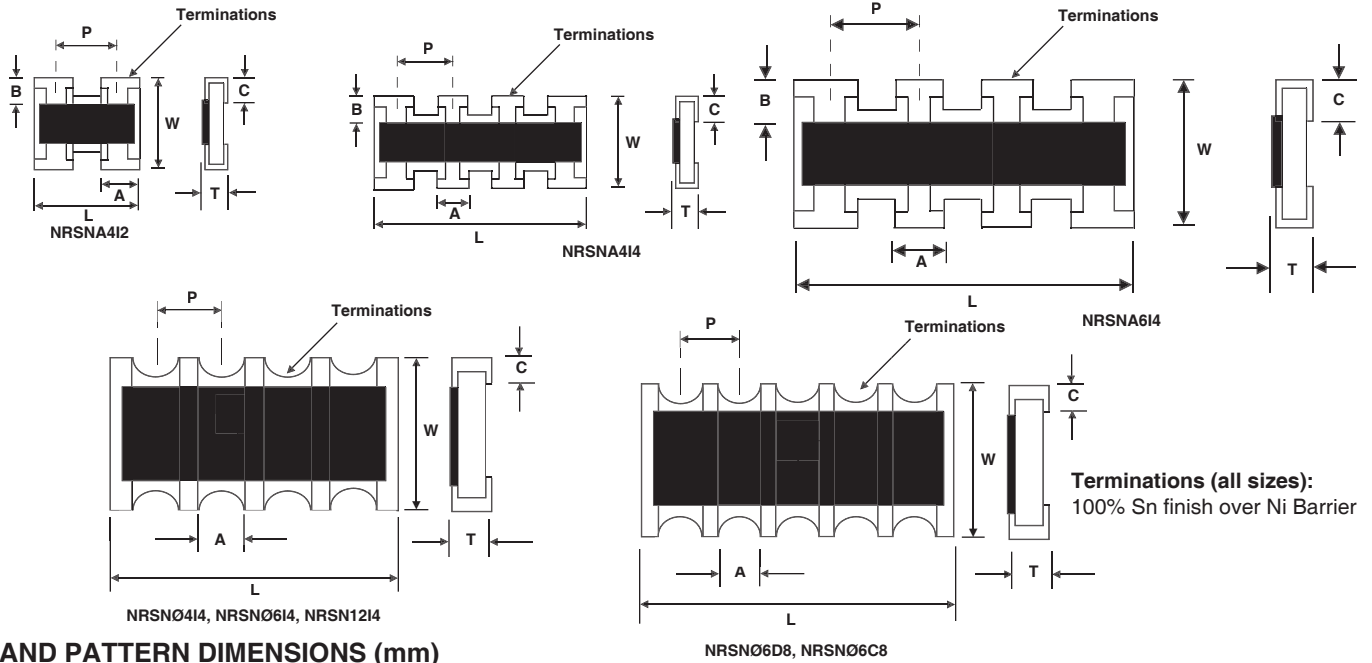

LAND PATTERN DIMENSIONS (mm)

Type	Reflow Soldering					Flow Soldering			
	A	B	P	S	F	A	B	P	F
NRSNA4I2	0.50	0.33	0.67	0.34	2.00	-	-	-	-
NRSNØ4I4	0.50	0.28	0.50	0.22	2.00	-	-	-	-
NRSNA4I4	0.50	0.28	0.50	0.22	2.00	-	-	-	-
NRSNØ6I4J	1.00	0.40	0.80	0.40	2.60	0.7 ~ 0.9	0.3 ~ 0.35	0.8	4.6 ~ 5.6
NRSNØ6I4J	1.00	0.40	0.80	0.40	2.60	0.7 ~ 0.9	0.3 ~ 0.35	0.8	4.6 ~ 5.6
NRSNØ6C8	2.20	0.50	1.27	-	4.20	1.9 ~ 2.1	0.5 ~ 0.55	1.27	5.6 ~ 6.2
NRSNØ6D8	2.20	0.50	1.27	-	4.20	1.9 ~ 2.1	0.5 ~ 0.55	1.27	5.6 ~ 6.2
NRSN12I4	2.20	0.790	1.27	-	4.20	1.0 ~ 1.2	0.4 ~ 0.45	1.27	5.6 ~ 6.2

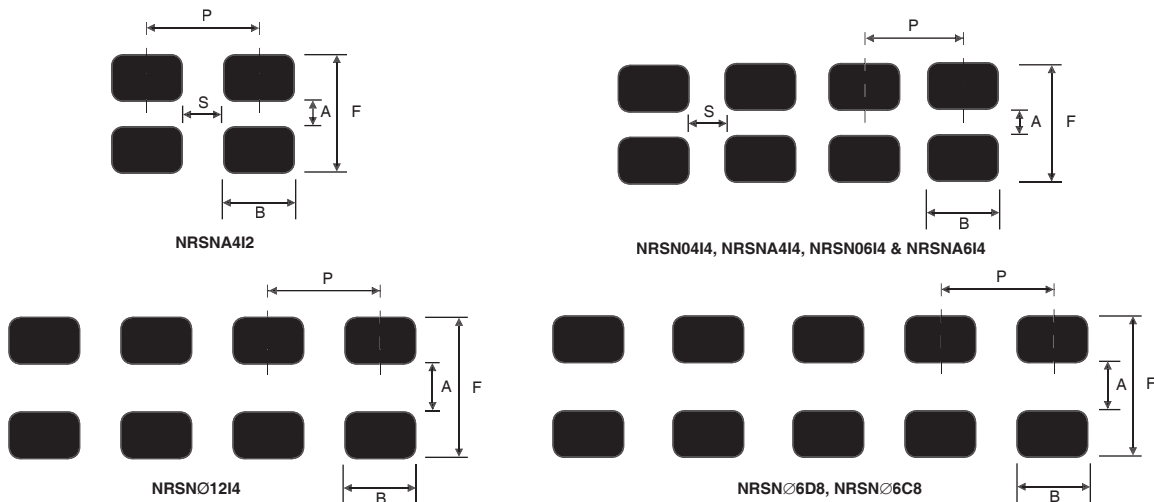

TAPE DIMENSIONS (mm)

Type	Material	A	B	F	p1	W	t ₁	t ₂
NRSNA4I2	Paper	1.17 ± 0.1	1.17 ± 0.1	3.5 ± 0.05	2.0 ± 0.05	8.0 ± 0.2	0.5 max.	1.0 max.
NRSN04I4		1.3 ± 0.2	2.3 ± 0.2		4.0 ± 0.1			
NRSNA4I4		2.0 ± 0.1	3.6 ± 0.1					
NRSN06I4	Plastic	3.5 ± 0.1	6.75 ± 0.1	5.5 ± 0.05	12.0 ± 0.2	1.0 max.	1.4 max.	
NRSNA6I4			5.7 ± 0.1					
NRSN06C8								
NRSN06D8								
NRSN12I4								

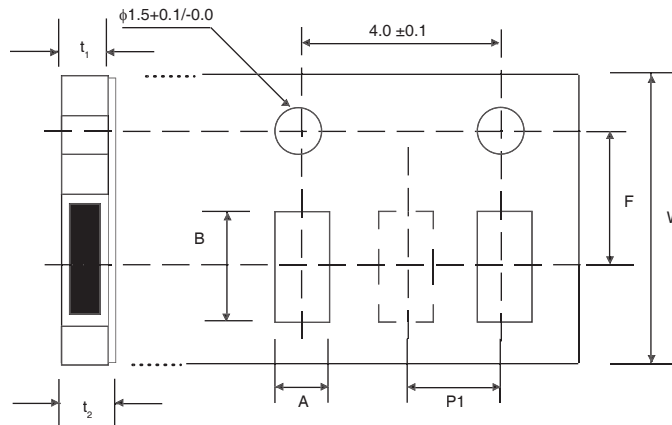

REEL DIMENSIONS (mm)

Type	A	B	C	D	E	W	Qty/Reel
NRSNA4I2	$\phi 180$ -4.0/+3.0	$\phi 60$ -4.0/+3.0	$\phi 13.0$ ± 2.0	$\phi 21.0$ ± 1.0	2.0 ± 0.5	8.0 ± 0.2	10,000
NRSN04I4						10 ± 1.0	5,000
NRSNA6I4		14 ± 2.0				4,000	
NRSN06C8		$\phi 80$ ± 2.0					
NRSN06D8							
NRSN12I4							

