



Multilayer ceramic capacitors

Leaded capacitors, C0G

Date: October 2006

Ordering code system

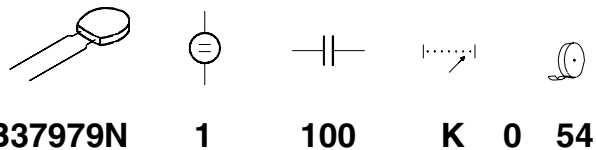

Packaging

51 \triangleq cardboard tape, reel packing (360-mm reel)
54 \triangleq Ammo packing (standard)
 00 \triangleq bulk

Internal coding

Capacitance tolerance

J \triangleq \pm 5% (standard for C0G)
K \triangleq \pm 10% (standard for X7R)
M \triangleq \pm 20% (standard for Z5U (Y5U))

Capacitance, coded 101 \triangleq 10 · 10¹ pF = 100 pF
 (example) 222 \triangleq 22 · 10² pF = 2.2 nF
 473 \triangleq 47 · 10³ pF = 47 nF

Rated voltage

Rated voltage [VDC]	50	100
Code	5	1

Type and size			
With radial leads EIA standard	Temperature characteristic		
	C0G	X7R	Z5U (Y5U)
Lead spacing 2.5 mm 5.5 × 5.0 × 2.5 6.5 × 5.0 × 2.5	B37979N B37986N	B37981M B37987M	B37982N B37988N
Lead spacing 5.0 mm 5.5 × 5.0 × 2.5 6.5 × 5.0 × 2.5 9.0 × 7.5 × 2.5	B37979G B37986G —	B37981F B37987F B37984M	B37982G B37988G B37985N

COG
Features

- Good thermal stability
- High insulation resistance
- Low dissipation factor
- Low inductance
- To AEC-Q200

Applications

- Resonant circuits
- Filter circuits
- Timing elements
- Coupling and filtering, particularly in RF circuits

Termination

- Parallel wire leads, iron-nickel, tinned
- Crimped leads
- Non-standard lead lengths on request

Marking

- Rated capacitance, tolerance, manufacturer's logo, ceramic material, voltage

Delivery mode

- Cardboard tape in Ammo packing (standard)
- Cardboard tape on 360-mm reel or bulk on request

Electrical data

Temperature characteristic		COG	
Climatic category (IEC 60068-1)		55/125/56	
Standard		EIA	
Dielectric		Class 1	
Rated voltage	V_R	50, 100	VDC
Test voltage	V_{test}	$2.5 \cdot V_R/5 s$	VDC
Capacitance range / E series	C_R	10 pF ... 10 nF (E6)	
Temperature coefficient		$0 \pm 30 \cdot 10^{-6}/K$	
Dissipation factor (limit value)	$\tan \delta$	$<1.0 \cdot 10^{-3}$	
Insulation resistance ¹⁾ at + 25 °C	R_{ins}	$>10^5$	MΩ
Insulation resistance ¹⁾ at +125 °C	R_{ins}	$>10^4$	MΩ
Time constant ¹⁾ at + 25 °C	τ	>1000	s
Time constant ¹⁾ at +125 °C	τ	>100	s
Operating temperature range	T_{op}	-55 ... +125	°C
Ageing		none	

1) For $C_R > 10$ nF the time constant $\tau = C \cdot R_{ins}$ is given.

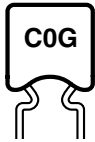

Multilayer ceramic capacitors

COG

Capacitance tolerances

Code letter	J (standard)	K
Tolerance	$\pm 5\%$	$\pm 10\%$

Dimensional drawing

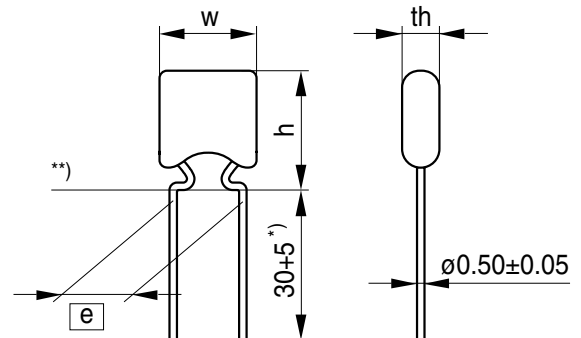

- *) Lead length for bulk packaging
 **) Seating plane to IEC 600717

KKE0456-R-E

Dimensions (mm)

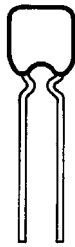
	Lead spacing \boxed{e} = 2.5 +0.6/-0.1 mm	
Type	B37979N	B37986N
		
h_{\max}	5.5	6.5
w_{\max}	5.0	5.0
th_{\max}	2.5	2.5

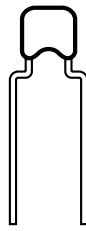
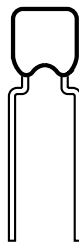
	Lead spacing \boxed{e} = 5.0 +0.6/-0.1 mm	
Type	B37979G	B37986G
		
h_{\max}	5.5	6.5
w_{\max}	5.0	5.0
th_{\max}	2.5	2.5

Termination

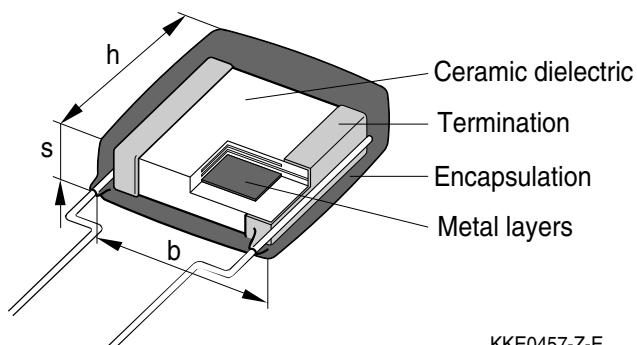

KKE0457-Z-E

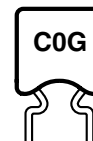

Product range leaded capacitors, C0G

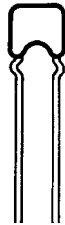
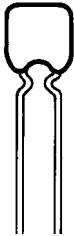
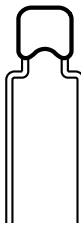
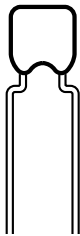
Lead spacing	2.5 mm				5.0 mm			
								
h × b × s (mm)	5.5 × 5.0 × 2.5		6.5 × 5.0 × 2.5		5.5 × 5.0 × 2.5		6.5 × 5.0 × 2.5	
Type	B37979N		B37986N		B37979G		B37986G	
V_R (VDC)	50	100	50	100	50	100	50	100
C_R								
10 pF								
15 pF								
22 pF								
33 pF								
47 pF								
68 pF								
100 pF								
150 pF								
220 pF								
330 pF								
470 pF								
680 pF								
1.0 nF								
1.5 nF								
2.2 nF								
3.3 nF								
4.7 nF								
6.8 nF								
10 nF								

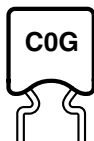
Multilayer ceramic capacitors
C0G
Ordering codes and packing for C0G, 50 VDC, lead spacing 2.5 mm

C _R	Ordering code ¹⁾	Ammo packing	Reel packing	Bulk
		** \triangleq 54	** \triangleq 51	** \triangleq 00
		pcs	pcs/reel	pcs

B37979, 50 VDC

100 pF	B37979N5101J0**	2500	2500	2000
150 pF	B37979N5151J0**	2500	2500	2000
220 pF	B37979N5221J0**	2500	2500	2000
330 pF	B37979N5331J0**	2500	2500	2000
470 pF	B37979N5471J0**	2500	2500	2000
680 pF	B37979N5681J0**	2500	2500	2000
1.0 nF	B37979N5102J0**	2500	2500	2000
1.5 nF	B37979N5152J0**	2500	2500	2000
2.2 nF	B37979N5222J0**	2500	2500	2000

B37986, 50 VDC

3.3 nF	B37986N5332J0**	2500	2500	2000
4.7 nF	B37986N5472J0**	2500	2500	2000
6.8 nF	B37986N5682J0**	2500	2500	2000
10 nF	B37986N5103J0**	2500	2500	2000

1) The table contains the ordering codes for the standard capacitance tolerance.
For other available capacitance tolerances see page 178.

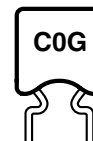
Multilayer ceramic capacitors
C0G
Ordering codes and packing for C0G, 50 VDC, lead spacing 5.0 mm

C _R	Ordering code ¹⁾	Ammo packing	Reel packing	Bulk
		** \triangle 54	** \triangle 51	** \triangle 00
		pcs	pcs/reel	pcs

B37979, 50 VDC

100 pF	B37979G5101J0**	2500	2500	2000
150 pF	B37979G5151J0**	2500	2500	2000
220 pF	B37979G5221J0**	2500	2500	2000
330 pF	B37979G5331J0**	2500	2500	2000
470 pF	B37979G5471J0**	2500	2500	2000
680 pF	B37979G5681J0**	2500	2500	2000
1.0 nF	B37979G5102J0**	2500	2500	2000
1.5 nF	B37979G5152J0**	2500	2500	2000
2.2 nF	B37979G5222J0**	2500	2500	2000

B37986, 50 VDC

3.3 nF	B37986G5332J0**	2500	2500	2000
4.7 nF	B37986G5472J0**	2500	2500	2000
6.8 nF	B37986G5682J0**	2500	2500	2000
10 nF	B37986G5103J0**	2500	2500	2000

1) The table contains the ordering codes for the standard capacitance tolerance.
For other available capacitance tolerances see page 178.

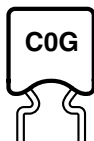
Multilayer ceramic capacitors
C0G
Ordering codes and packing for C0G, 100 VDC, lead spacing 2.5 mm

C _R	Ordering code ¹⁾	Ammo packing	Reel packing	Bulk
		** \triangle 54	** \triangle 51	** \triangle 00
		pcs	pcs/reel	pcs

B37979, 100 VDC

10 pF	B37979N1100J0**	2500	2500	2000
15 pF	B37979N1150J0**	2500	2500	2000
22 pF	B37979N1220J0**	2500	2500	2000
33 pF	B37979N1330J0**	2500	2500	2000
47 pF	B37979N1470J0**	2500	2500	2000
68 pF	B37979N1680J0**	2500	2500	2000
100 pF	B37979N1101J0**	2500	2500	2000
150 pF	B37979N1151J0**	2500	2500	2000
220 pF	B37979N1221J0**	2500	2500	2000
330 pF	B37979N1331J0**	2500	2500	2000
470 pF	B37979N1471J0**	2500	2500	2000
680 pF	B37979N1681J0**	2500	2500	2000
1.0 nF	B37979N1102J0**	2500	2500	2000

B37986, 100 VDC

1.5 nF	B37986N1152J0**	2500	2500	2000
2.2 nF	B37986N1222J0**	2500	2500	2000

1) The table contains the ordering codes for the standard capacitance tolerance.
For other available capacitance tolerances see page 178.

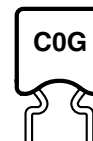
Multilayer ceramic capacitors
C0G
Ordering codes and packing for C0G, 100 VDC, lead spacing 5.0 mm

C _R	Ordering code ¹⁾	Ammo packing	Reel packing	Bulk
		** \triangle 54	** \triangle 51	** \triangle 00
		pcs	pcs/reel	pcs

B37979, 100 VDC

10 pF	B37979G1100J0**	2500	2500	2000
15 pF	B37979G1150J0**	2500	2500	2000
22 pF	B37979G1220J0**	2500	2500	2000
33 pF	B37979G1330J0**	2500	2500	2000
47 pF	B37979G1470J0**	2500	2500	2000
68 pF	B37979G1680J0**	2500	2500	2000
100 pF	B37979G1101J0**	2500	2500	2000
150 pF	B37979G1151J0**	2500	2500	2000
220 pF	B37979G1221J0**	2500	2500	2000
330 pF	B37979G1331J0**	2500	2500	2000
390 pF	B37979G1391J0**	2500	2500	2000
470 pF	B37979G1471J0**	2500	2500	2000
680 pF	B37979G1681J0**	2500	2500	2000
1.0 nF	B37979G1102J0**	2500	2500	2000

B37986, 100 VDC

1.5 nF	B37986G1152J0**	2500	2500	2000
2.2 nF	B37986G1222J0**	2500	2500	2000

1) The table contains the ordering codes for the standard capacitance tolerance.
For other available capacitance tolerances see page 178.

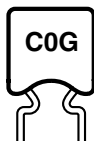

Typical characteristics

Capacitance change $\Delta C/C_{25}$ versus temperature T (tolerance range $\pm 0.2\%$)

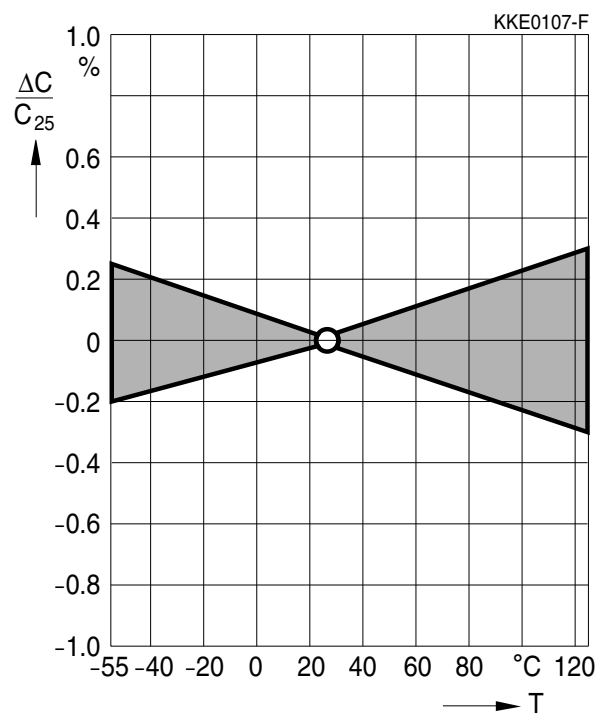

Capacitance change $\Delta C/C_0$ versus superimposed DC voltage V

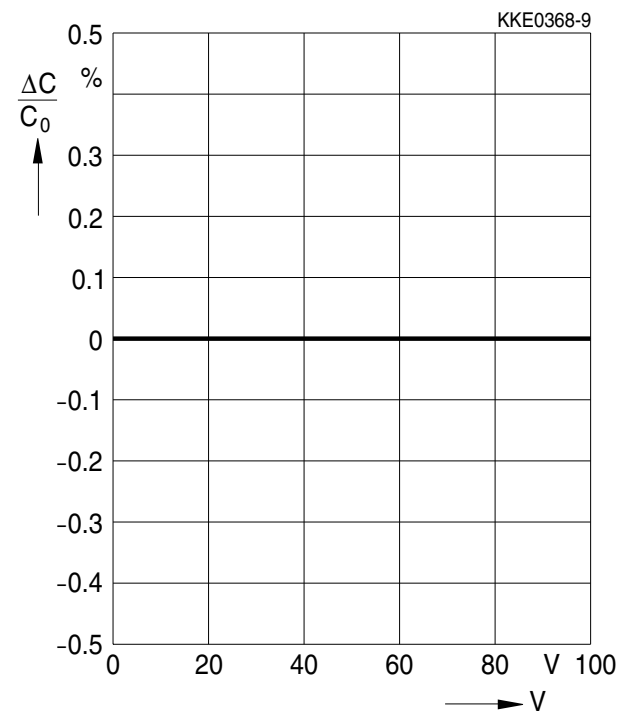

Insulation resistance R_{ins} versus temperature T

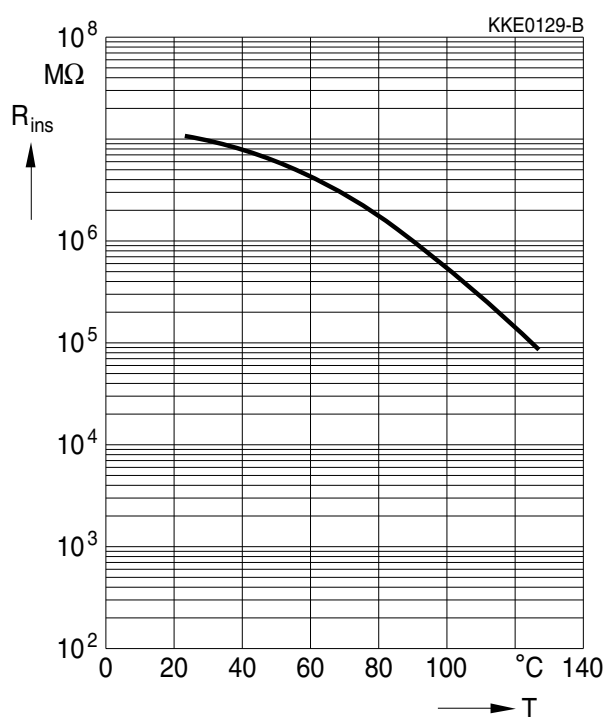

Dissipation factor $\tan \delta$ versus temperature T

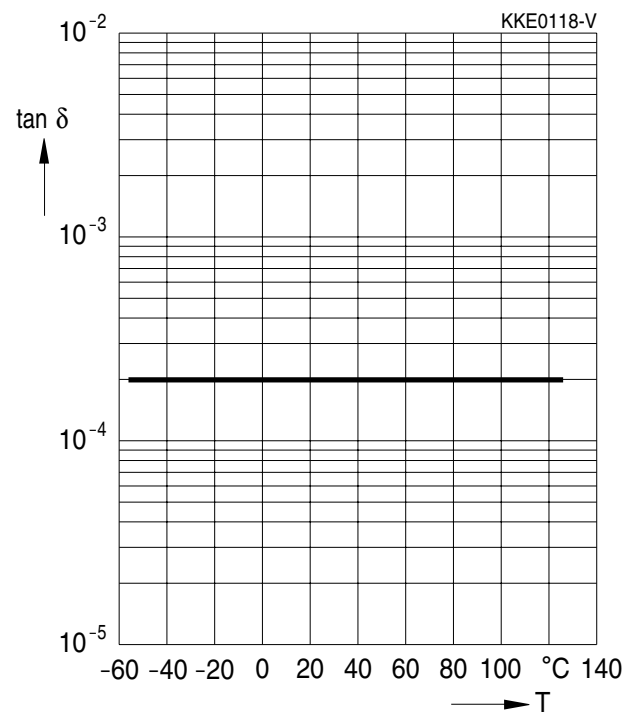

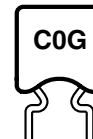

Typical characteristics

Impedance $|Z|$ versus frequency f

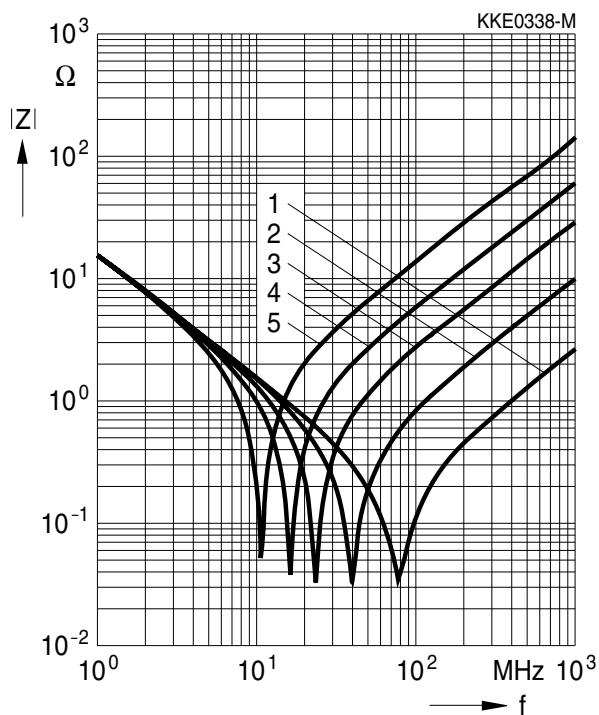

- 1: SMD chip capacitor
- 2: 1.5 mm lead length
- 3: 5.0 mm lead length
- 4: 10.0 mm lead length
- 5: 20.0 mm lead length

Capacitance change $\Delta C/C_1$ versus time t

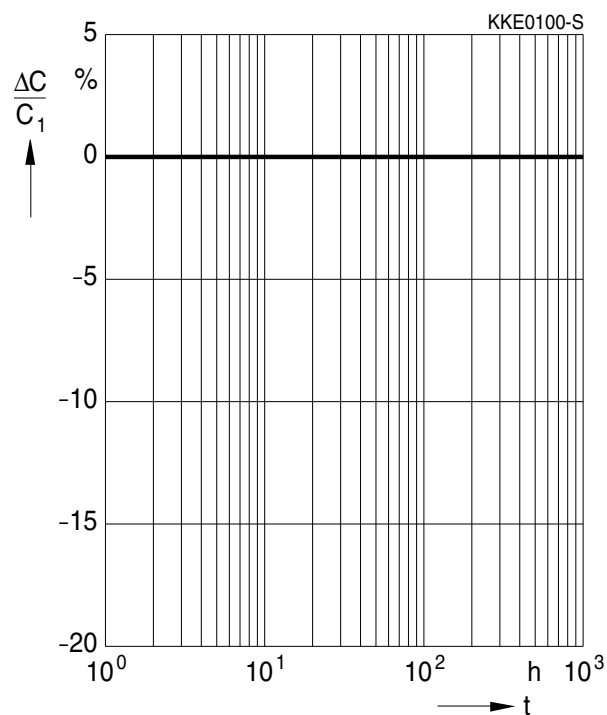

Notes on the selection of ceramic capacitors

In the selection of ceramic capacitors, the following criteria must be considered:

1. Depending on the application, ceramic capacitors used to meet high quality requirements should at least satisfy the specifications to AEC-Q200. They must meet quality requirements going beyond this level in terms of ruggedness (e.g. mechanical, thermal or electrical) in the case of critical circuit configurations and applications (e.g. in safety-relevant applications such as ABS and airbag equipment or durable industrial goods).
2. At the connection to the battery or power supply (e.g. clamp 15 or 30 in the automobile) and at positions with stranding potential, to reduce the probability of short circuits following a fracture, two ceramic capacitors must be connected in series and/or a ceramic capacitor with integrated series circuit should be used. The MLSC from EPCOS contains such a series circuit in a single component.
3. Ceramic capacitors with the temperature characteristics Z5U and Y5V do not satisfy the requirements to AEC-Q200 and are mechanically and electrically less rugged than C0G or X7R/X8R ceramic capacitors. In applications that must satisfy high quality requirements, therefore, these capacitors should not be used as discrete components (see the chapter “Effects on mechanical, thermal and electrical stress”, point 1.4).
4. For ESD protection, preference should be given to the use of multilayer varistors (MLV) (see the chapter “Effects on mechanical, thermal and electrical stress”, point 1.4).
5. An application-specific derating or continuous operating voltage must be considered in order to cushion (unexpected) additional stresses (see the chapter “Reliability”).

The following should be considered in circuit board design

1. If technically feasible in the application, preference should be given to components having an optimal geometrical design.
2. At least FR4 circuit board material should be used.
3. Geometrically optimal circuit boards should be used, ideally those that cannot be deformed.
4. Ceramic capacitors must always be placed a sufficient minimum distance from the edge of the circuit board. High bending forces may be exerted there when the panels are separated and during further processing of the board (such as when incorporating it into a housing).
5. Ceramic capacitors should always be placed parallel to the possible bending axis of the circuit board.
6. No screw connections should be used to fix the board or to connect several boards. Components should not be placed near screw holes. If screw connections are unavoidable, they must be cushioned (for instance by rubber pads).

The following should be considered in the placement process

1. Ensure correct positioning of the ceramic capacitor on the solder pad.
2. Caution when using casting, injection-molded and molding compounds and cleaning agents, as these may damage the capacitor.
3. Support the circuit board and reduce the placement forces.
4. A board should not be straightened (manually) if it has been distorted by soldering.
5. Separate panels with a peripheral saw, or better with a milling head (no dicing or breaking).
6. Caution in the subsequent placement of heavy or leaded components (e.g. transformers or snap-in components): danger of bending and fracture.
7. When testing, transporting, packing or incorporating the board, avoid any deformation of the board not to damage the components.
8. Avoid the use of excessive force when plugging a connector into a device soldered onto the board.
9. Ceramic capacitors must be soldered only by the mode (reflow or wave soldering) permissible for them (see the chapter "Soldering directions").
10. When soldering the most gentle solder profile feasible should be selected (heating time, peak temperature, cooling time) in order to avoid thermal stresses and damage.
11. Ensure the correct solder meniscus height and solder quantity.
12. Ensure correct dosing of the cement quantity.
13. Ceramic capacitors with an AgPd external termination are not suited for the lead-free solder process: they were developed only for conductive adhesion technology.

This listing does not claim to be complete, but merely reflects the experience of EPCOS AG.

The following applies to all products named in this publication:

1. Some parts of this publication contain **statements about the suitability of our products for certain areas of application**. These statements are based on our knowledge of typical requirements that are often placed on our products in the areas of application concerned. We nevertheless expressly point out **that such statements cannot be regarded as binding statements about the suitability of our products for a particular customer application**. As a rule, EPCOS is either unfamiliar with individual customer applications or less familiar with them than the customers themselves. For these reasons, it is always ultimately incumbent on the customer to check and decide whether an EPCOS product with the properties described in the product specification is suitable for use in a particular customer application.
2. We also point out that **in individual cases, a malfunction of passive electronic components or failure before the end of their usual service life cannot be completely ruled out in the current state of the art, even if they are operated as specified**. In customer applications requiring a very high level of operational safety and especially in customer applications in which the malfunction or failure of a passive electronic component could endanger human life or health (e.g. in accident prevention or life-saving systems), it must therefore be ensured by means of suitable design of the customer application or other action taken by the customer (e.g. installation of protective circuitry or redundancy) that no injury or damage is sustained by third parties in the event of malfunction or failure of a passive electronic component.
3. **The warnings, cautions and product-specific notes must be observed.**
4. In order to satisfy certain technical requirements, **some of the products described in this publication may contain substances subject to restrictions in certain jurisdictions (e.g. because they are classed as “hazardous”)**. Useful information on this will be found in our Material Data Sheets on the Internet (www.epcos.com/material). Should you have any more detailed questions, please contact our sales offices.
5. We constantly strive to improve our products. Consequently, **the products described in this publication may change from time to time**. The same is true of the corresponding product specifications. Please check therefore to what extent product descriptions and specifications contained in this publication are still applicable before or when you place an order.
We also **reserve the right to discontinue production and delivery of products**. Consequently, we cannot guarantee that all products named in this publication will always be available.
6. Unless otherwise agreed in individual contracts, **all orders are subject to the current version of the “General Terms of Delivery for Products and Services in the Electrical Industry” published by the German Electrical and Electronics Industry Association (ZVEI)**.
7. The trade names EPCOS, EPCOS-JONES, Baoke, CeraDiode, CSSP, MLSC, PhaseCap, PhaseMod, SIFERRIT, SIFI, SIKOREL, SilverCap, SIMID, SIOV, SIP5D, SIP5K, UltraCap, WindCap are **trademarks registered or pending** in Europe and in other countries. Further information will be found on the Internet at www.epcos.com/trademarks.