

Resistor Chip

Size 0603

5%

9C06031A....J

(2322 702)

FEATURES

- Reduced size of final equipment
- Lower assembly costs
- Higher component and equipment reliability
- Improved performance at high frequencies

DESCRIPTION

The resistors are constructed on a high grade ceramic body (aluminum oxide). Internal metal electrodes are added at each end and connected by a resistive paste which is applied to the top surface of the substrate. The composition of the paste is adjusted to give the approximate resistance required and the value is trimmed to within tolerance by laser cutting of this resistance layer.

The resistive layer is covered with a protective coating and printed with the resistance value. The two external end terminations are added along with a nickel barrier coat. For ease of soldering, the outer layer of these end terminations is a tin/lead alloy.

MASS: 0.21 g per 100 units

QUICK REFERENCE DATA

Resistance Range	1 Ω to 6.8 M Ω ; E24 Series and Jumper (0 Ω)
Resistance Tolerance	$\pm 5\%$
Temperature Coefficient R < 10 Ω 10 Ω \leq R < 1 M Ω 1 M Ω \leq R \leq 6.8 M Ω	$\leq -200 / + 500$ ppm/ $^{\circ}$ C $\leq \pm 200$ ppm/ $^{\circ}$ C $\leq \pm 300$ ppm/ $^{\circ}$ C
Abs. Max. Dissipation at T _{amb} = 70 $^{\circ}$ C	0.063 W
Max. Continuous Operating Voltage	50 V (DC or RMS)
Operating Temperature Range	-55 $^{\circ}$ C to + 125 $^{\circ}$ C
Basic Specification	IEC 115-8
Stability after: Load, 1000 hrs at T _{amb} = 70 $^{\circ}$ C 10 Ω \leq R \leq 1 M Ω R < 10 Ω ; R > 1 M Ω Climatic Tests Temperature Cycling, -55 $^{\circ}$ C to 125 $^{\circ}$ C Resistance to Soldering Heat Short Time Overload, 100 V max. Bending Test, min. 5 mm	$\Delta R/R$ Max: 3.0% + 0.10 Ω $\Delta R/R$ Max: 5.0% + 0.10 Ω $\Delta R/R$ Max: 1.0% + 0.05 Ω $\Delta R/R$ Max: 1.0% + 0.05 Ω $\Delta R/R$ Max: 1.0% + 0.05 Ω $\Delta R/R$ Max: 1.0% + 0.05 Ω

Note

$\pm 2\%$ Tolerance available upon request.

MECHANICAL DATA

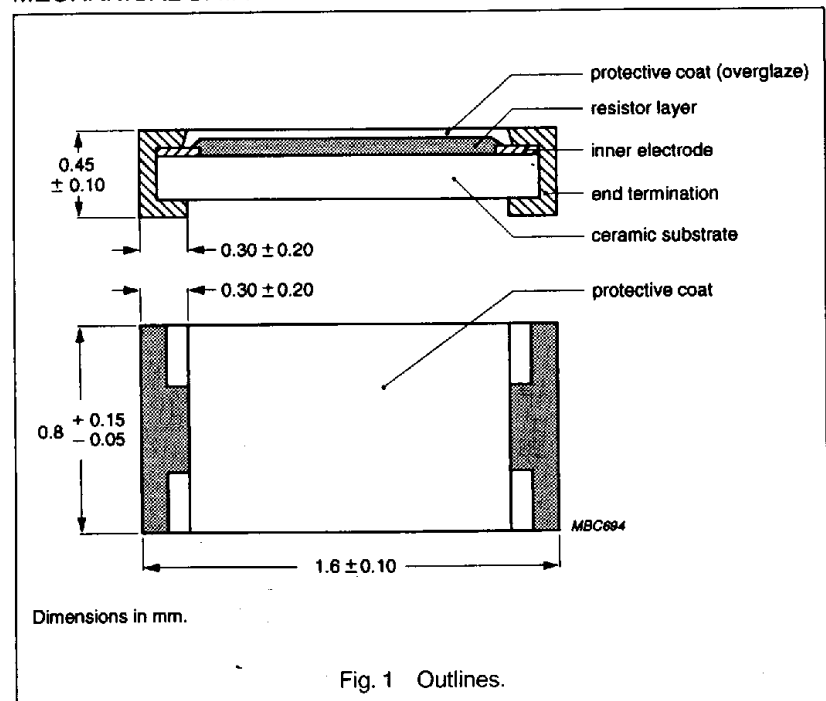

Resistor Chip
Size 0603
5%

9C06031A....J
(2322 702)

MOUNTING

Due to their rectangular shape and small tolerances on the dimensions, Surface Mounted Resistors are suitable for handling by automatic placement systems. Chip placement is possible on ceramic substrates and printed-circuit boards (PCB's). Electrical connection to the circuit is made by wave, vapor phase, or infrared soldering. The end terminations guarantee a reliable contact and the protective coating enables "face down" mounting.

The robust construction of the device allows it to be completely immersed in a solder bath of 260°C for up to one minute. Therefore, it is possible to mount Surface Mounted Resistors on one side of a PCB and other discrete components on the reverse side (mixes PCB's).

SOLDERING CONDITIONS

Surface Mounted Resistors are tested for solderability at a temperature of 235°C during 2 seconds. The test condition for no leaching is 260°C for 60 seconds. Typical examples of soldering processes that provide reliable joints without any damage are given in Figs. 2, 3, and 4.

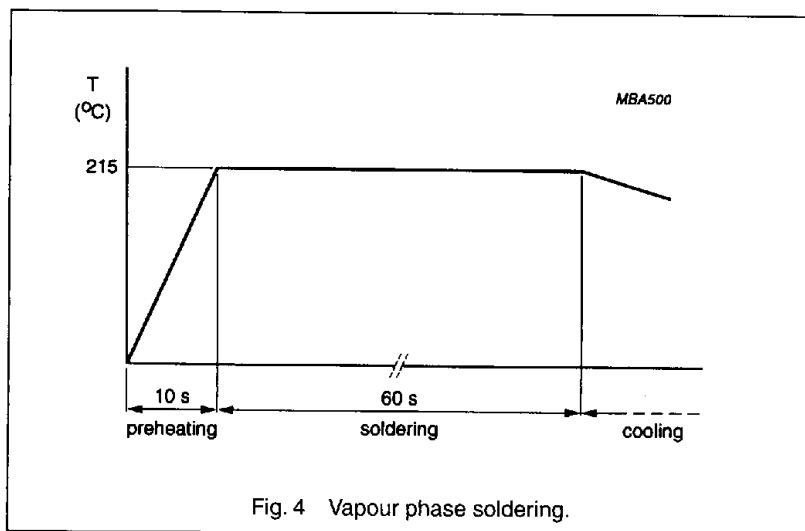
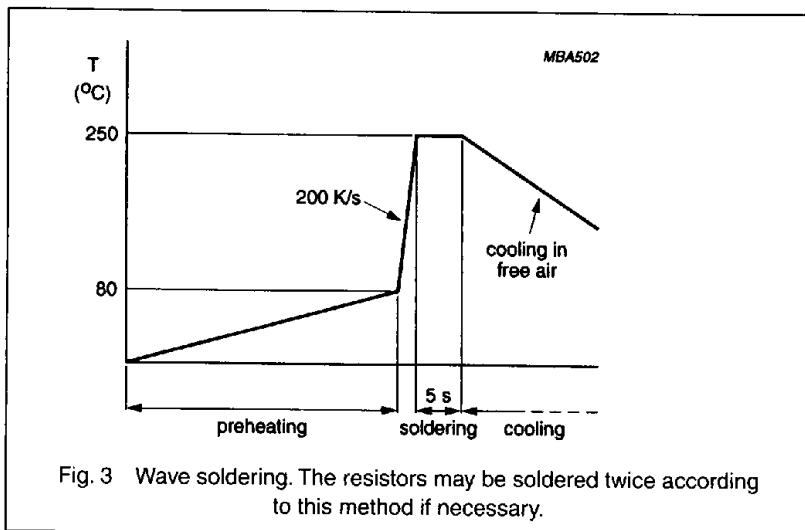
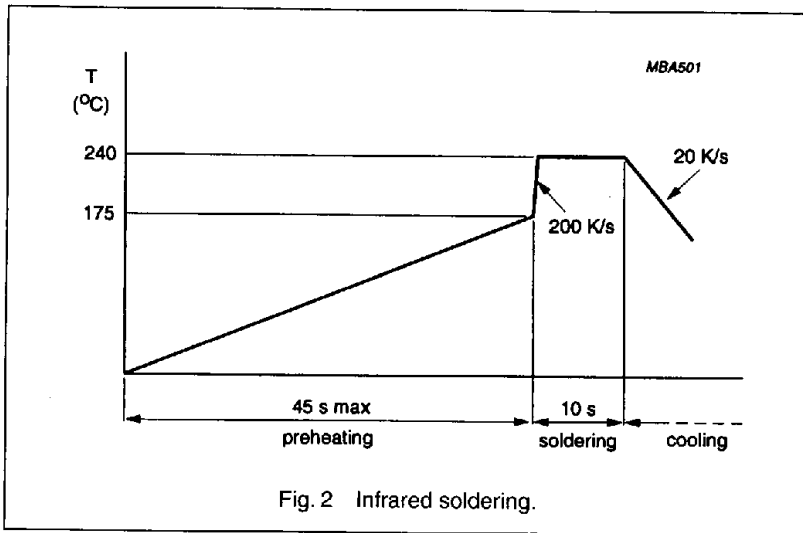

Resistor Chip
Size 0603
5%

9C06031A....J
(2322 702)

MARKING

Each resistor is marked with a three digit code on the protective coating to designate the nominal resistance value. For values up to 91 Ω , "R" is used as the decimal point. For values of 100 Ω and higher, the first two digits are significant, and the third digit indicates the number of "0's" to follow. The 0 Ω , Jumper, is marked "000".

100 to 910 Ω	1
1 to 9.1 K Ω	2
10 to 91 K Ω	3
100 to 910 K Ω	4
1 M Ω to 6.8 M Ω	5

Examples:

12R = 12 Ω
 471 = 470 Ω
 823 = 82 K Ω

The packing is also marked and includes resistance value, tolerance, TCR, catalogue number, quantity, production period, batch number, and source code.

ELECTRICAL DATA

Standard values of nominal resistance are taken from the E24 series for resistors with a tolerance of $\pm 5\%$. The values of this series are in accordance with IEC Publication 63.

The maximum continuous working voltage (DC or RMS) is 50 V. This is the maximum voltage that may be continuously applied to the resistor element.

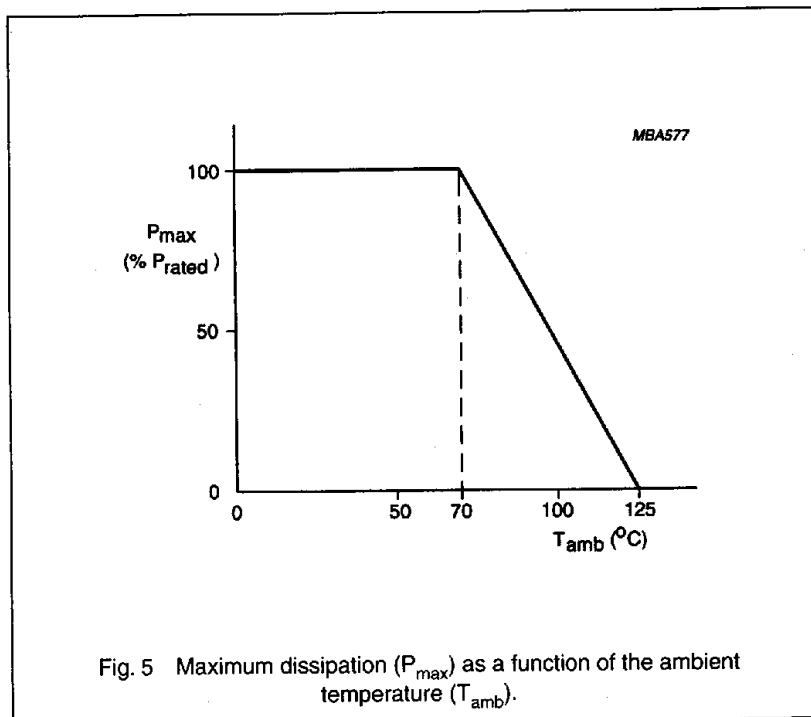

Fig. 5 Maximum dissipation (P_{max}) as a function of the ambient temperature (T_{amb}).

DISSIPATION

The rated power that the resistor can dissipate depends on the operating temperature. See Fig. 5.

The 0 Ω , jumper has a maximum resistance $R_{max} = 50$ m Ω and a rated current $I_R = 1$ A.

PULSE LOAD BEHAVIOR

The Pulse Load Behavior is determined in accordance with the method outlined in the "General Section". The results are shown in Figs. 6, 7, and 8.

Resistor Chip
Size 0603
5%

9C06031A....J
(2322 702

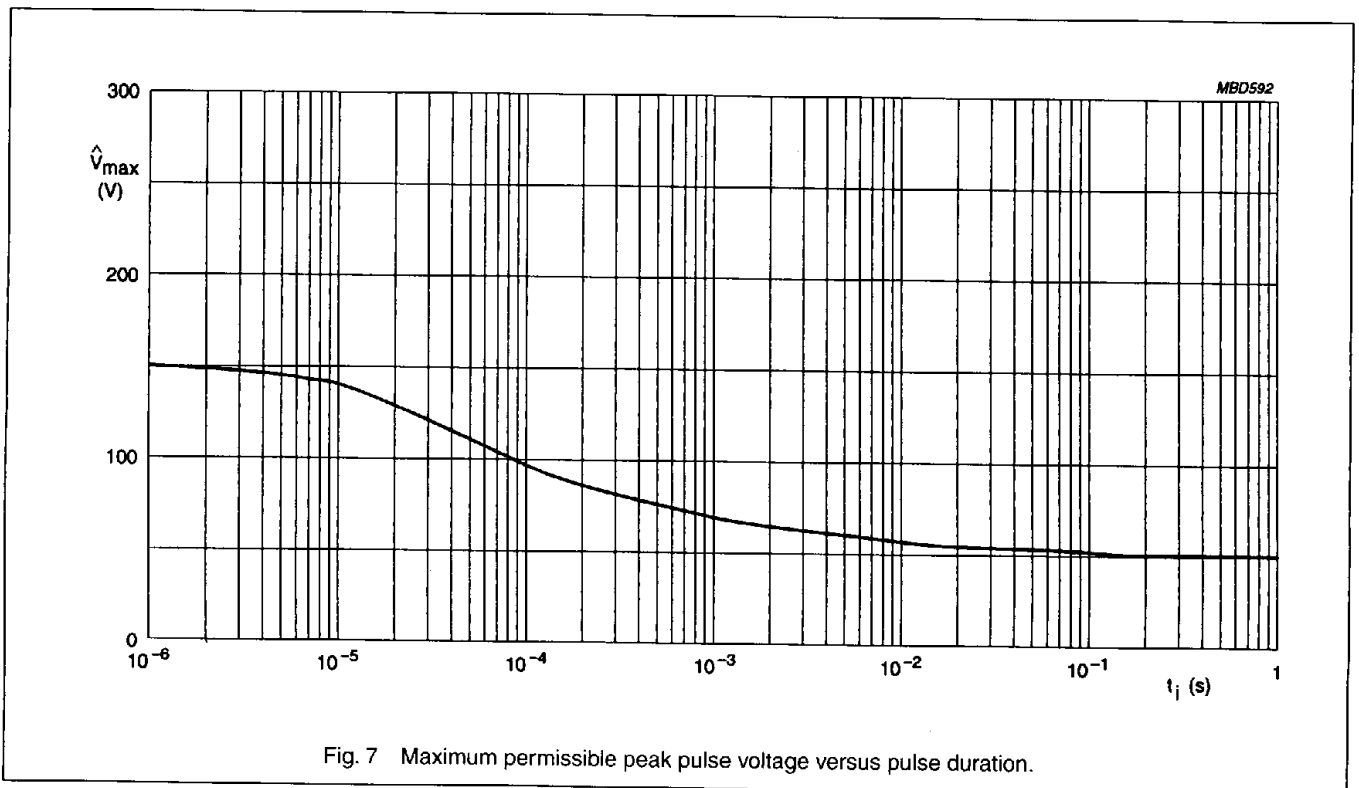
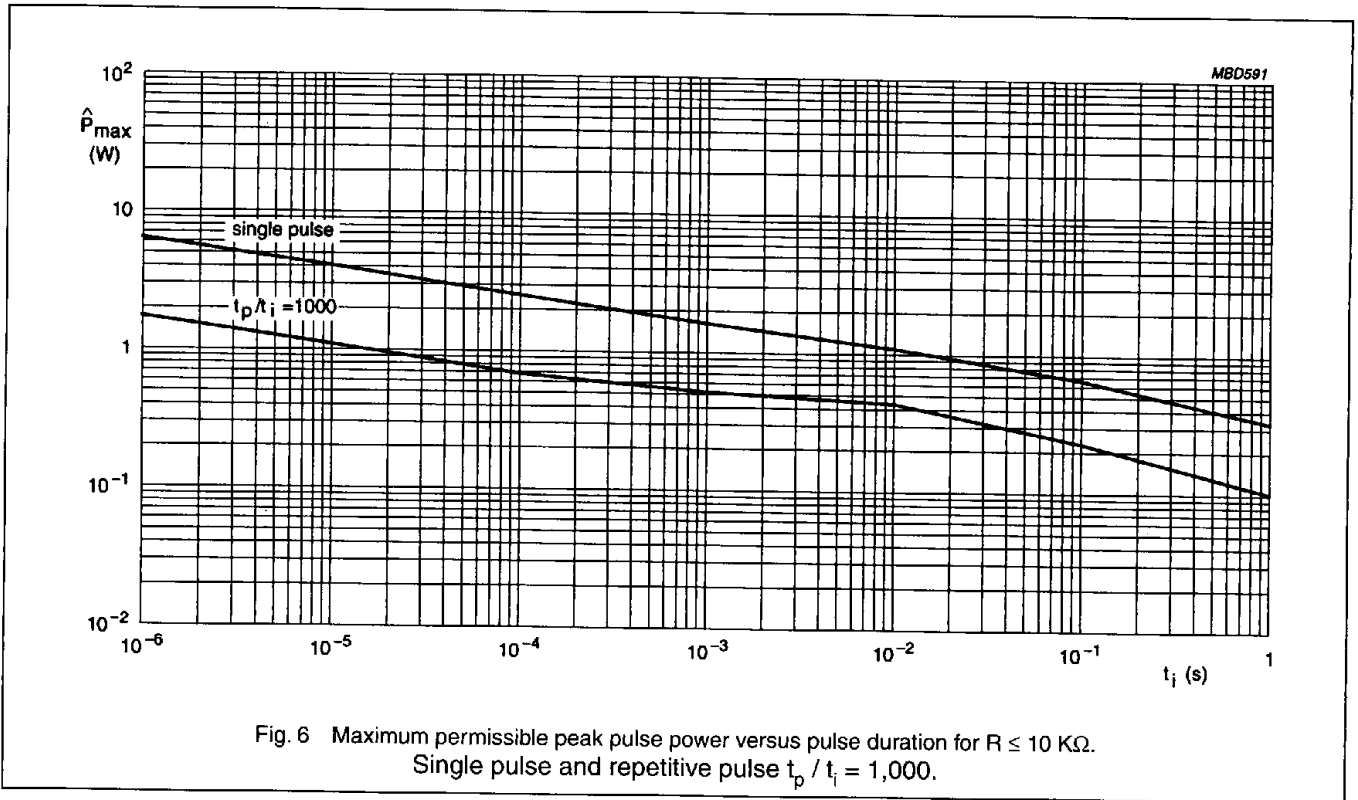

Resistor Chip
Size 0603
5%

9C06031A....J
(2322 702)

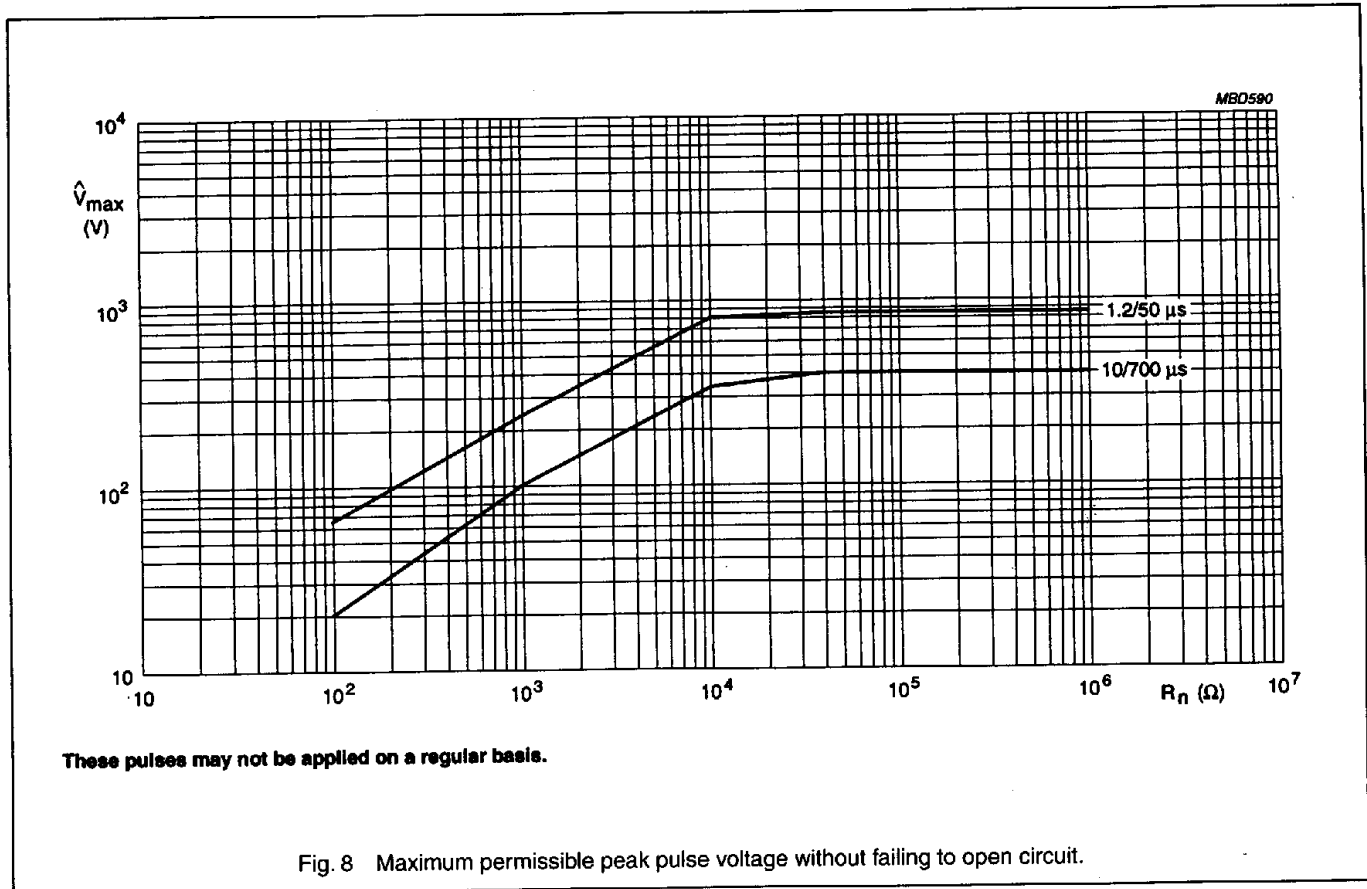

ORDERING INFORMATION

North American Part Number

Table 1

Resistance Range	Tol. \pm %	Series	Part Number
1 Ω to 6.8 M Ω and 0 Ω	5	E24/96	9C06031A....J

The "...." in the part number represents the value of the resistor. The value is composed of three significant figures followed by a multiplier to indicate the number of "0's" to follow. For values less than 100 Ω 's, a "R" is used as the decimal place (12 Ω is 12R0).

Examples:

100 Ω = 1000
 51,000 Ω = 5102
 1,500,000 Ω = 1504

4,700 Ω = 4701
 330,000 Ω = 3303

Resistor Chip
Size 0603
5%

9C06031A....J
(2322 702

International Part Number

Table 2 The resistor part numbers start with 2322. Subsequent digits indicate packaging and resistance as listed in this table.

Resistance	Tol \pm %	Series	2322	
			Cardboard Tape	
			5000 reel	10,000 reel
1 Ω to 6.8 M Ω	5	E24	702 60...	702 70...
0 Ω Jumper			702 96001	702 97001

Note

5000 piece cardboard tape reels are standard. Other packaging is available on special order.

Table 3 To complete the part number (see Table 2), replace the first two dots of the remaining code with the first two digits of the resistance value. Replace the third dot with a figure as shown in this table.

Nominal Resistance Range	Last Digit of Part Number
1 Ω to 9.1 Ω	8
10 Ω to 91 Ω	9
100 Ω to 910 Ω	1
1 K Ω to 9.1 K Ω	2
10 K Ω to 91 K Ω	3
100 K Ω to 910 K Ω	4
1 M Ω to 6.8 Ω	5

Precision Resistor Chip

Size 0603

1%

9C06031A....F

(2322 704.....)

FEATURES

- Reduced size of final equipment
- Lower assembly costs
- Higher component and equipment reliability
- Improved performance at high frequencies

DESCRIPTION

The resistors are constructed on a high grade ceramic body (aluminum oxide). Internal metal electrodes are added at each end and connected by a resistive paste which is applied to the top surface of the substrate. The composition of the paste is adjusted to give the approximate resistance required and the value is trimmed to within tolerance by laser cutting of this resistance layer.

The resistive layer is covered with a protective coating and printed with the resistance value. The two external end terminations are added along with a nickel barrier coat. For ease of soldering, the outer layer of these end terminations is a tin/lead alloy.

MASS: 0.25 g per 100 units

QUICK REFERENCE DATA

Resistance Range	1Ω to 1 MΩ; E24/96 Series
Resistance Tolerance	± 1%
Temperature Coefficient	1 Ω to 4.99 Ω ≤ ± 250 ppm/°C 5.1 Ω to 97.6 Ω ≤ ± 200 ppm/°C 100 Ω to 1 MΩ ≤ ± 100 ppm/°C
Abs. Max. Dissipation at $T_{amb} = 70^{\circ}\text{C}$	0.063 W
Max. Continuous Operating Voltage	50 V (DC or RMS)
Operating Temperature Range	-55°C to +125°C
Basic Specification	EIA 575/IEC 115-8
Stability after:	
Load, 1000 hrs at $T_{amb} = 70^{\circ}\text{C}$	ΔR/R Max: 1.0% + 0.05 Ω
Climatic Tests	ΔR/R Max: 1.0% + 0.05 Ω
Resistance to Soldering Heat	ΔR/R Max: 0.5% + 0.05 Ω
Short Time Overload, 100 V. max.	ΔR/R Max: 1.0% + 0.05 Ω

MECHANICAL DATA

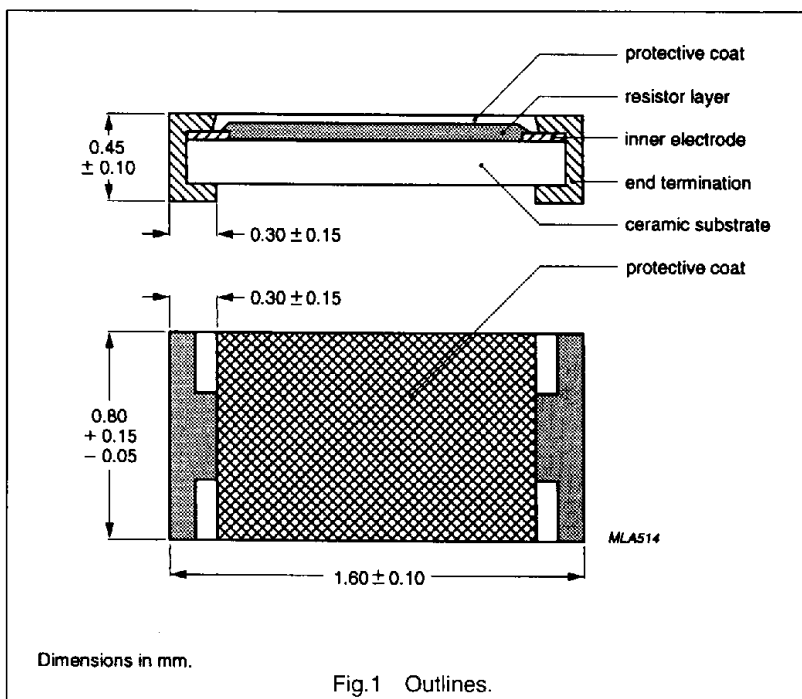

Precision Resistor Chip
Size 0603
1%

9C06031A...F
(2322 704.....)

MOUNTING

Due to their rectangular shape and small tolerances on the dimensions, Surface Mounted Resistors are suitable for handling by automatic placement systems. Chip placement is possible on ceramic substrates and printed-circuit boards (PCB's). Electrical connection to the circuit is made by wave, vapor phase, or infrared soldering. The end terminations guarantee a reliable contact and the protective coating enables "face down" mounting.

The robust construction of the device allows it to be completely immersed in a solder bath of 260°C for up to one minute.

Therefore, it is possible to mount Surface Mounted Resistors on one side of a PCB and other discrete components on the reverse side (mixed PCB's).

SOLDERING CONDITIONS

Surface Mounted Resistors are tested for solderability at a temperature of 230°C during 2 seconds. The test condition for no leaching is 260°C for 60 seconds. Typical examples of soldering processes that provide reliable joints without any damage are given in Figs. 2, 3, and 4.

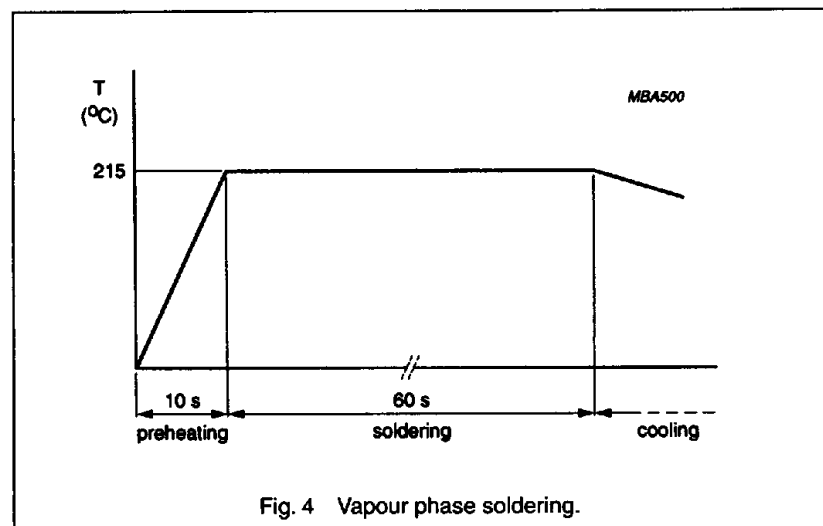
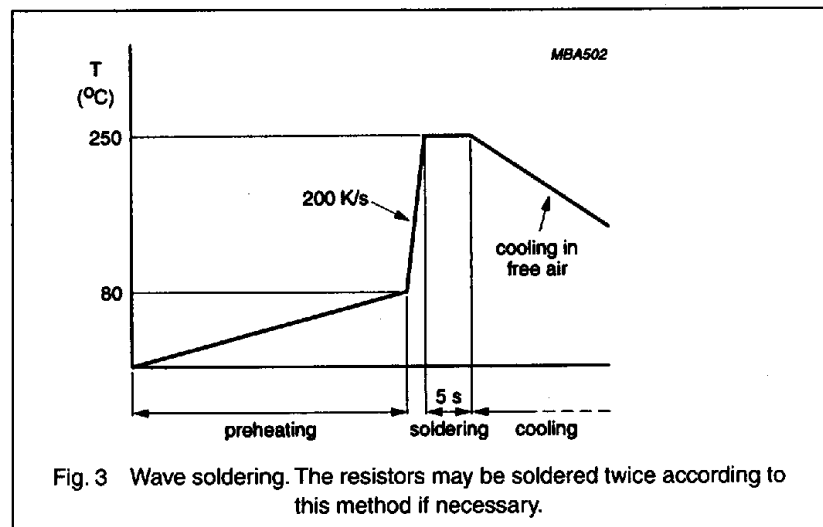
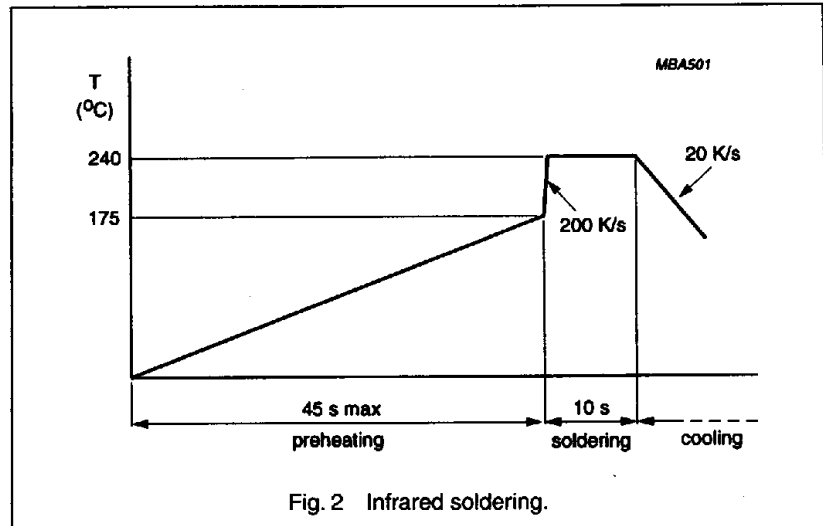

Precision Resistor Chip
Size 0603
1%

9C06031A....F
(2322 704.....)

MARKING

Due to the small size of the 0603 chip resistor, no marking is applied to the individual chips.

The packing is marked and includes resistance value, tolerance, TCR, catalogue number, quantity, production period, batch number, and source code.

ELECTRICAL DATA

Standard values of nominal resistance are taken from the E24/96 series for resistors with a tolerance of $\pm 1\%$. The values of these series are in accordance with IEC Publication 63.

The maximum continuous working voltage (DC or RMS) is 50 V. This is the maximum voltage that may be continuously applied to the resistor element.

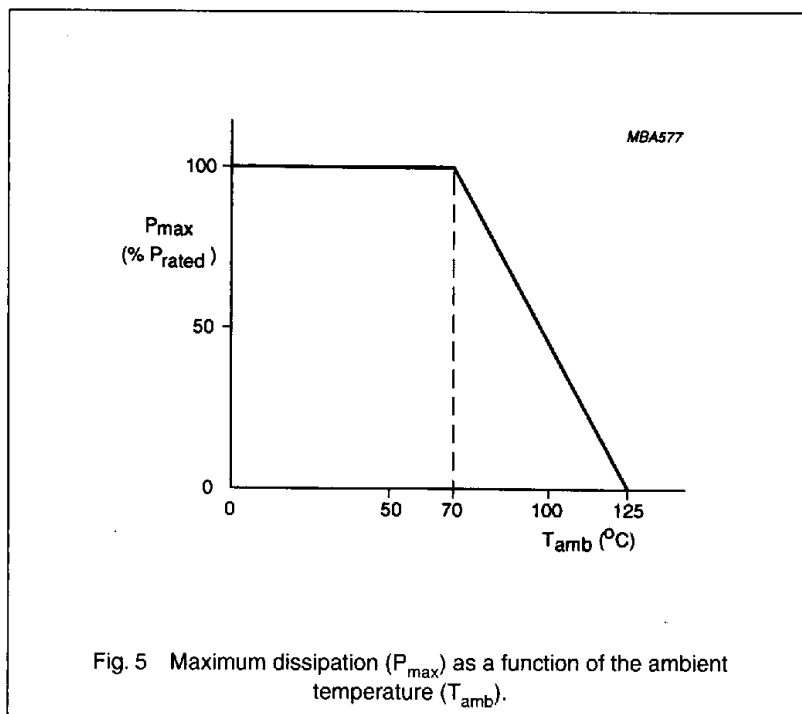

Fig. 5 Maximum dissipation (P_{max}) as a function of the ambient temperature (T_{amb}).

DISSIPATION

The rated power that the resistor can dissipate depends on the operating temperature. See Fig. 5.

PULSE LOAD BEHAVIOR

The Pulse Load Behavior is determined in accordance with the method outlined in the "General Section". The results are shown in Figs. 6, 7, and 8.

Precision Resistor Chip
Size 0603
1%

9C06031A...F
(2322 704.....)

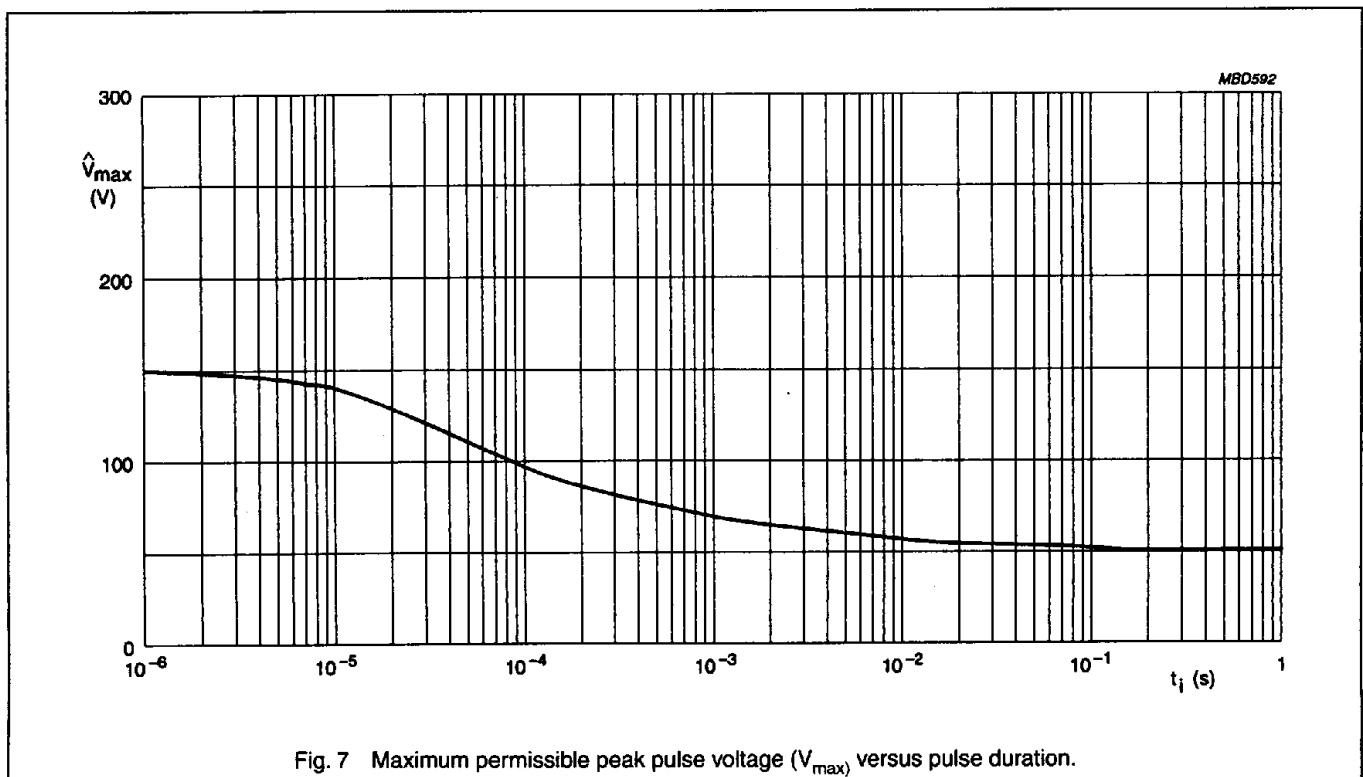
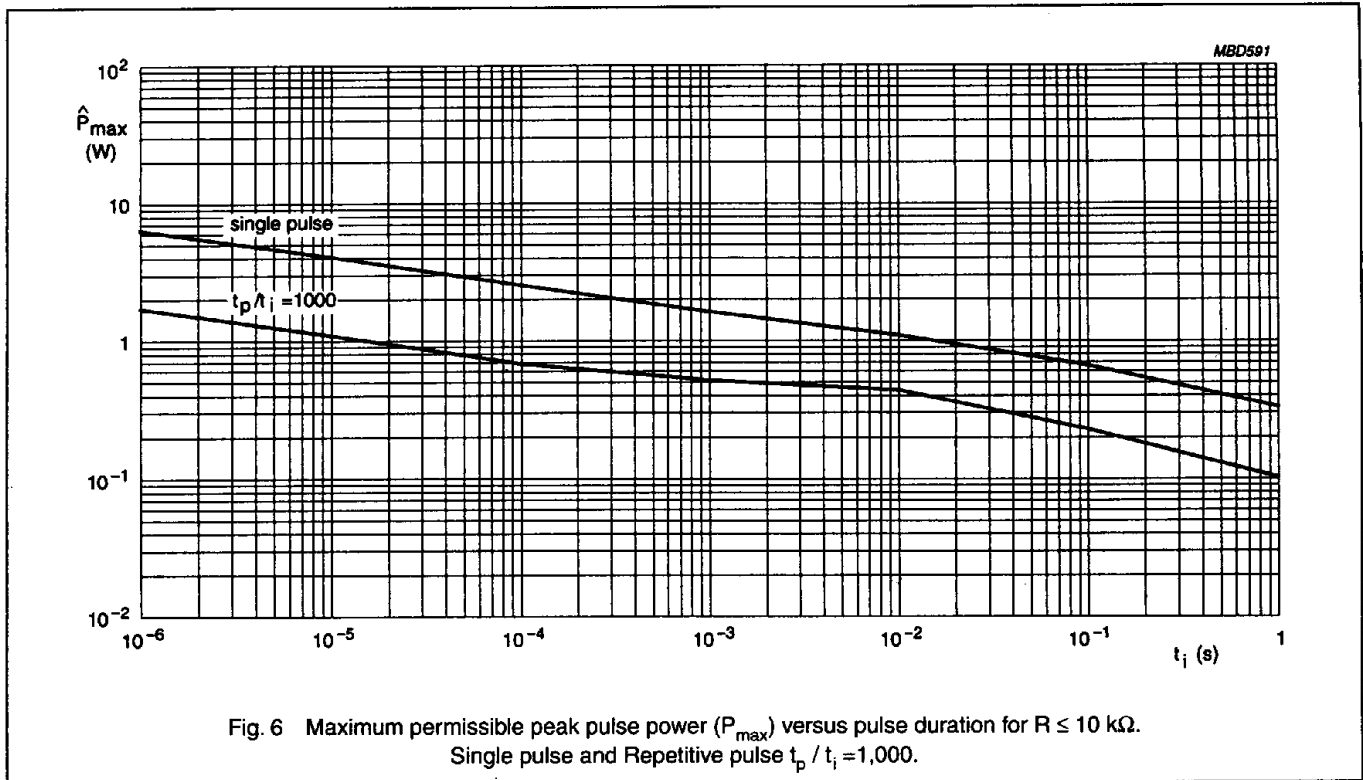

Precision Resistor Chip
Size 0603
1%

9C06031A....F
(2322 704.....)

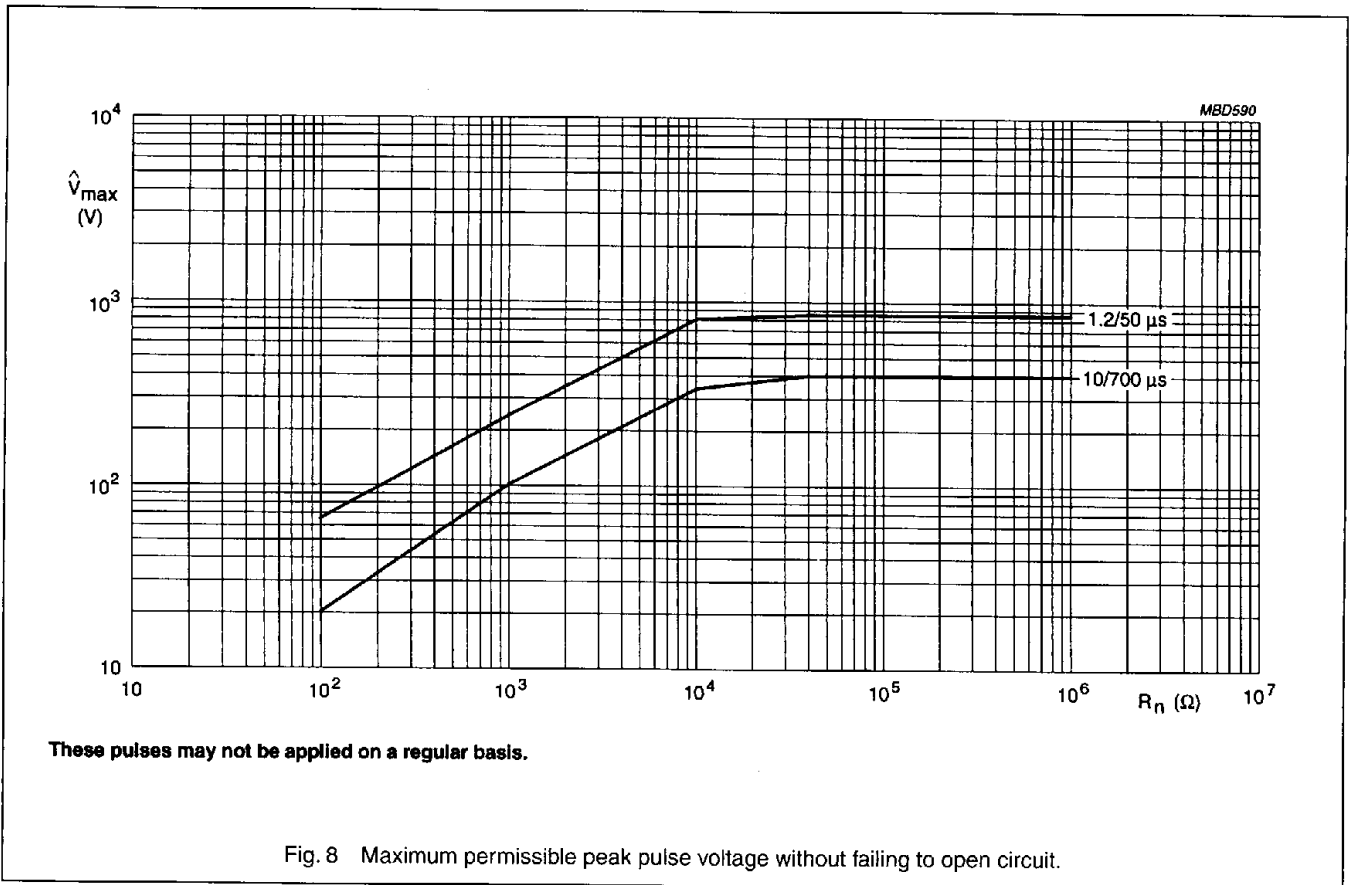

ORDERING INFORMATION

North America Part Number

Table 1

Resistance Range	Tol. ± %	Series	Part Number
1Ω to 1 MΩ	1	E24/96	9C12063A....F

The "..." in the part number represents the value of the resistor. The value is composed of three significant figures followed by a multiplier to indicate the number of "0's" to follow. For values less than 100 Ω's, a "R" is used as the decimal place (49.9 Ω is 49R9).

Examples:

100 Ω = 1000
51,000 Ω = 5102
1,500,000 Ω = 1504

4,700 Ω = 4701
330,000 Ω = 3303

Precision Resistor Chip
Size 0603
1%

9C06031A....F
(2322 704.....)

International Part Number

Table 2 The resistor part numbers start with 2322. Subsequent digits indicate packaging and resistance as listed in this table.

Resistance Range	Tol \pm %	Series	2322 704	
			Cardboard Tape	
			5000 reel	10,000 reel
1 Ω to 1 M Ω	1	E24/E96	6....	7....

Note

5000 piece cardboard tape reels are standard. Other packaging is available on special order.

Table 3 To complete the part number (see Table 2), replace the first three dots of the remaining code with the first three digits of the resistance value. Replace the fourth dot with a figure as shown in this table.

Nominal Resistance Range	Last Digit of Part Number
1 Ω to 9.76 Ω	8
10 Ω to 97.6 Ω	9
100 Ω to 976 Ω	1
1 K Ω to 9.76 K Ω	2
10 K Ω to 97.6 K Ω	3
100 K Ω to 976 K Ω	4
1 M Ω	5