

Spezifikation für Freigabe / specification for release

Kunde / customer :

Artikelnummer / part number : **7443340470**



Bezeichnung : **SPEICHERDROSSEL WE-HCC 8070 (Ferrit)**

description : **POWER-CHOKE WE-HCC 8070 (Ferrite)**

DATUM / DATE : 2011-09-02

A Mechanische Abmessungen / dimensions:

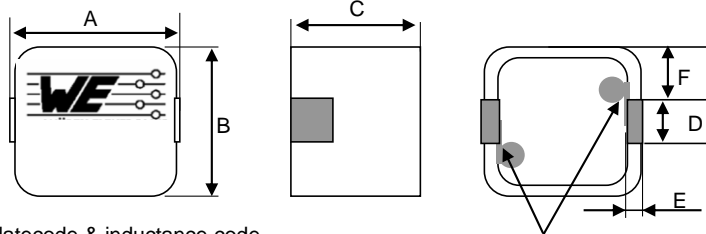

datecode & inductance code marking at side wall

RDC is measured at these points

A	8,4 ± 0,4	mm
B	7,9 ± 0,3	mm
C	7,2 ± 0,3	mm
D	2,3 ± 0,2	mm
E	1,5 ± 0,2	mm
F	2,75 ± 0,5	mm

B Elektrische Eigenschaften / electrical properties:

C Lötpad / soldering spec.:

Eigenschaften / properties	Testbedingungen / test conditions		Wert / value	Einheit / unit	tol.
Lerlaufinduktivität / initial inductance	100 kHz / 10mA	L_0	4,70	μH	$\pm 20\%$
DC-Widerstand / DC-resistance	@ 20° C	R_{DC}	12,40	$\text{m}\Omega$	$\pm 10\%$
Nennstrom / rated current	$\Delta T = 50 \text{ K}$	I_N	7,5	A	max.
Sättigungsstrom / saturation current	$\Delta L / L_0 = 30 \%$	I_{sat}	8,0	A	typ.
Eigenres.-Frequenz / self-res.-frequency		SRF	45,0	MHz	typ.

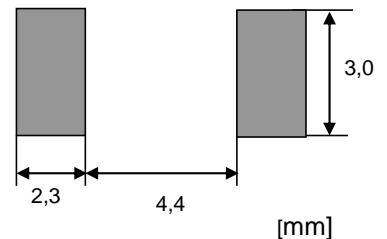

D Prüfgeräte / test equipment:

E Testbedingungen / test conditions:

WAYNE KERR 3260B für/for L_0 ; I_{SAT}
HP 34401 A & Fluke 5411 für/for I_{DC} ;
Metra HIT 271 für/for R_{DC}

Luftfeuchtigkeit / humidity: 33%
 Umgebungstemperatur / temperature: +20°C

F Werkstoffe & Zulassungen / material & approvals:

G Eigenschaften / general specifications:

Basismaterial / base material: Ferrite
 Draht / wire: JIS 155°C , UL : E201757

Arbeitstemperatur / operating temperature: -40°C - +125°C
 Lagertemp. / storage temperature: -40°C - +60°C
 It is recommended that the temperature of the part does not exceed 125°C under worst case operating conditions.

Freigabe erteilt / general release:	Kunde / customer			
Datum / date	Unterschrift / signature			
	Würth Elektronik			
Geprüft / checked	Kontrolliert / approved	BD	Version 1	11-09-02
		Name	Änderung / modification	Datum / date

Würth Elektronik eiSos GmbH & Co. KG

D-74638 Waldenburg · Max-Eyth-Strasse 1 - 3 · Germany · Telefon (+49) (0) 7942 - 945 - 0 · Telefax (+49) (0) 7942 - 945 - 400
<http://www.we-online.de>

Spezifikation für Freigabe / specification for release

Kunde / customer :

Artikelnummer / part number : **7443340470**

LF



Bezeichnung : **SPEICHERDROSSEL WE-HCC 8070 (Ferrit)**

description : **POWER-CHOKER WE-HCC 8070 (Ferrite)**

WÜRTH ELEKTRONIK

DATUM / DATE : 2011-09-02

H Induktivitätskurve / Inductance curve:

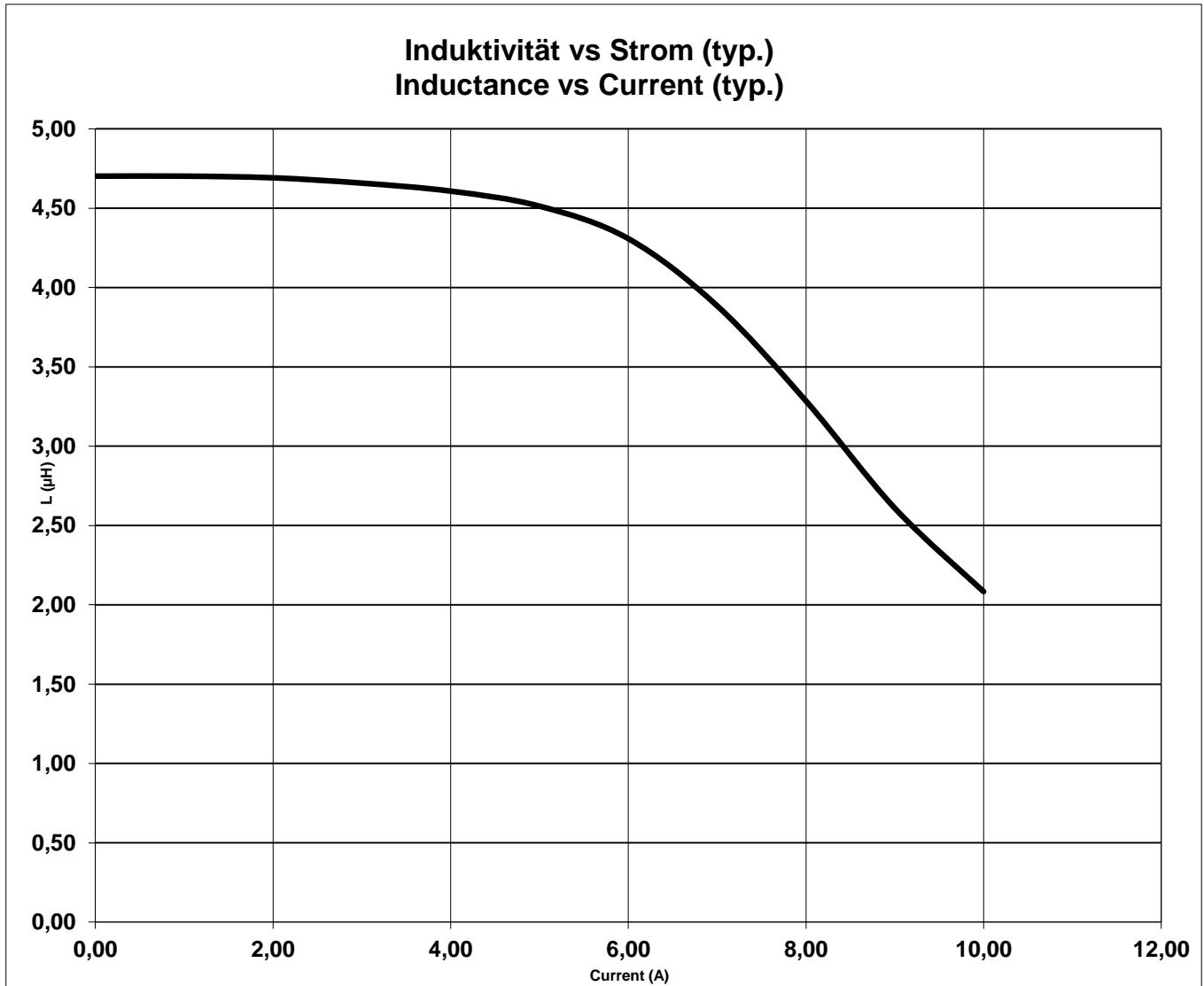

Freigabe erteilt / general release:	Kunde / customer			
.....			
Datum / date	Unterschrift / signature			
	Würth Elektronik			
.....			
Geprüft / checked	Kontrolliert / approved	BD	Version 1	11-09-02
		Name	Änderung / modification	Datum / date

Würth Elektronik eiSos GmbH & Co. KG

D-74638 Waldenburg · Max-Eyth-Strasse 1 - 3 · Germany · Telefon (+49) (0) 7942 - 945 - 0 · Telefax (+49) (0) 7942 - 945 - 400
<http://www.we-online.de>

Spezifikation für Freigabe / specification for release

Kunde / customer :
 Artikelnummer / part number : **7443340470**
 Bezeichnung : **SPEICHERDROSSEL WE-HCC 8070 (Ferrit)**
 description : **POWER-CHOKE WE-HCC 8070 (Ferrite)**



DATUM / DATE : 2011-09-02

I Temperaturanstieg / Temperature rise curve:

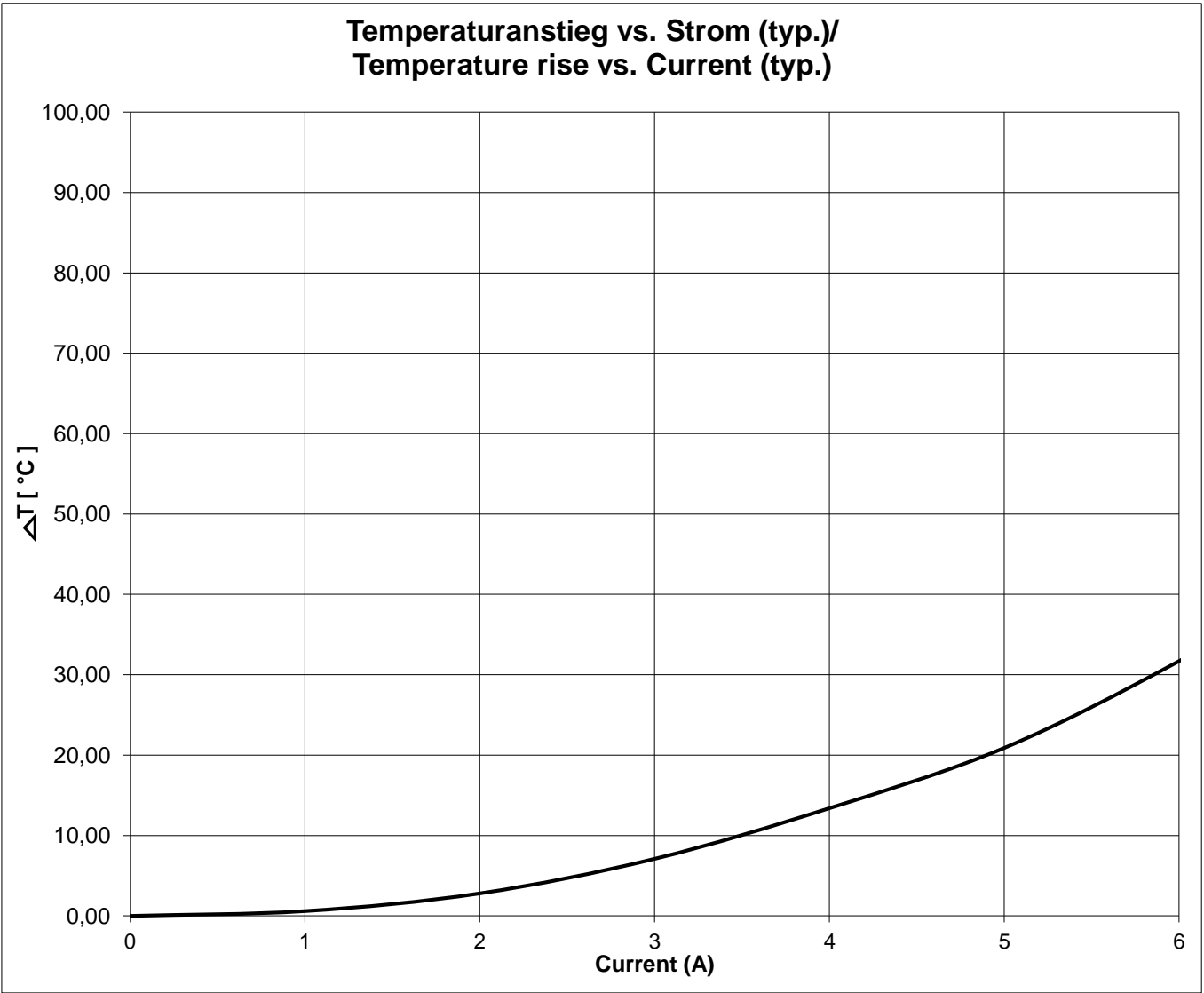

Freigabe erteilt / general release:	Kunde / customer			
Datum / date	Unterschrift / signature			
	Würth Elektronik			
Geprüft / checked	Kontrolliert / approved	BD	Version 1	11-09-02
		Name	Änderung / modification	Datum / date

Würth Elektronik eiSos GmbH & Co. KG

D-74638 Waldenburg · Max-Eyth-Strasse 1 - 3 · Germany · Telefon (+49) (0) 7942 - 945 - 0 · Telefax (+49) (0) 7942 - 945 - 400
<http://www.we-online.de>

Spezifikation für Freigabe / specification for release

Kunde / customer :

Artikelnummer / part number :

7443340470

LF



Bezeichnung : **SPEICHERDROSSEL WE-HCC 8070 (Ferrit)**

description : **POWER-CHOKE WE-HCC 8070 (Ferrite)**

DATUM / DATE : 2011-09-02

J Rollenspezifikation / tape and reel specification:

Gurtspezifikation / Tape specification:

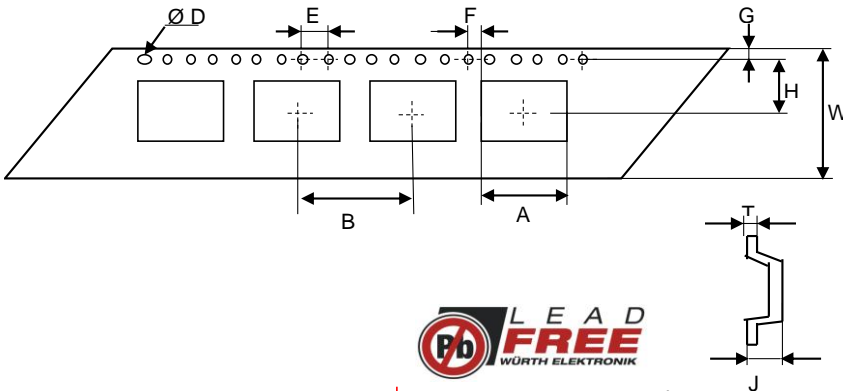

A	8,25 ± 0,1	mm
B	16 ± 0,1	mm
		mm
D	1,50 ± 0,1	mm
E	4,00 ± 0,1	mm
F	2,00 ± 0,1	mm
G	1,75 ± 0,1	mm
H	11,5 ± 0,1	mm
		mm
J	7,40 ± 0,1	mm
T	0,40 ± 0,05	mm
W	24,0 ± 0,3	mm

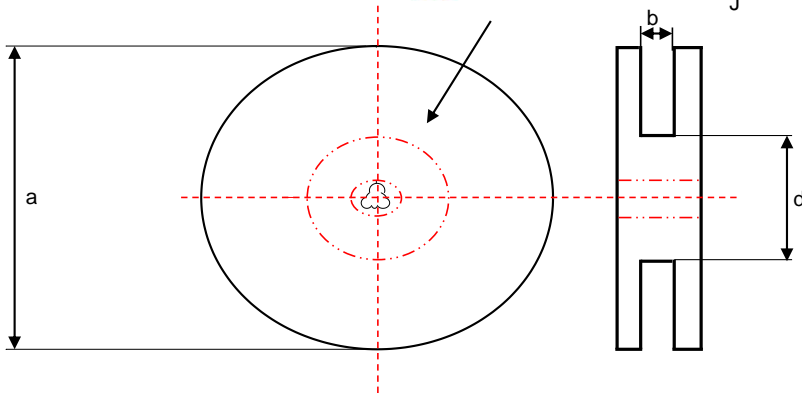

Rollenspezifikation / Reel specification:

a	330,0 ref	mm
b	24,0 ref	mm
		mm
d	75 ± 2	mm

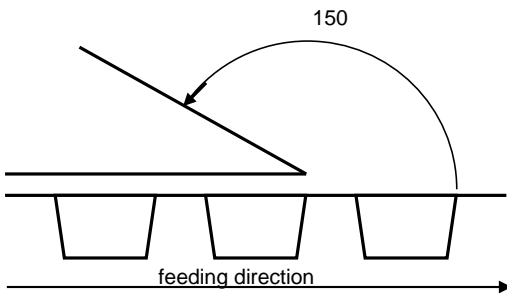

The Force for tearing off cover tape is 20 to 70 grams in arrow direction

Freigabe erteilt / general release:

	Kunde / customer		
.....		
Datum / date	Unterschrift / signature		
	Würth Elektronik		
.....		
Geprüft / checked	Kontrolliert / approved	BD	Version 1
		Name	Änderung / modification
			Datum / date

This electronic component has been designed and developed for usage in general electronic equipment. Before incorporating this component into any equipment where higher safety and reliability is especially required or if there is the possibility of direct damage or injury to human body, for example in the range of aerospace, aviation, nuclear control, submarine, transportation, (automotive control, train control, ship control), transportation signal, disaster prevention, medical, public information network etc, Würth Elektronik eiSos GmbH must be informed before the design-in stage. In addition, sufficient reliability evaluation checks for safety must be performed on every electronic component which is used in electrical circuits that require high safety and reliability functions or performance.

Würth Elektronik eiSos GmbH & Co. KG

D-74638 Waldenburg · Max-Eyth-Strasse 1 - 3 · Germany · Telefon (+49) (0) 7942 - 945 - 0 · Telefax (+49) (0) 7942 - 945 - 400
http://www.we-online.com