

Spezifikation für Freigabe / specification for release

Kunde / customer : _____
 Artikelnummer / part number : **7427143** LF
 Bezeichnung : **RINGKERN MIT GEHÄUSE - KLAPPBAR**
 description : **SPLIT FERRITE RING WITH HOUSING**



DATUM / DATE : 2005-03-16

A Mechanische Abmessungen / dimensions:

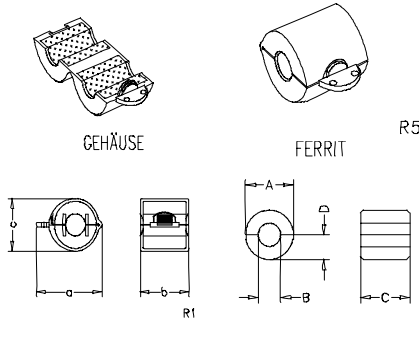

a	25,5	mm					
b	19,5	mm					
c	21,0	mm					
A	16,3	mm					
B	8,2	mm					
C	16,0	mm					
D	8,2	mm					

B Elektrische Eigenschaften / electrical properties:

Eigenschaften / properties	Testbedingungen / test conditions		Wert / value	Einheit / unit	Tol.
Impedanz @ 1 Wg./ impedance @ 1 turn	25 MHz	Z	64	Ω	± 25%
Impedanz @ 1 Wg./ impedance @ 1 turn	100 MHz	Z	106	Ω	± 25%
Impedanz @ 2 Wg./ impedance @ 2 turn	25 MHz	Z	291	Ω	± 25%
Impedanz @ 2 Wg./ impedance @ 2 turn	100 MHz	Z	504	Ω	± 25%

C



D Prüfgeräte / test equipment:

HP 4191 B für/for Z und/and material
16092A - Klemme / clamp
AWG26 - Ø 0,5mm - Länge/length: 165 mm

E Testbedingungen / test conditions:

Luftfeuchtigkeit / humidity: 33%
 Umgebungstemperatur / temperature: + 20°C

F Werkstoffe & Zulassungen / material & approvals:

Basismaterial / base material: 4 W 620
 Kunststoff / plastic material: PA 6
 UL-Zulassungen / UL-approval: UL94-V0 / E76261 (M)

G Eigenschaften / general specifications:

Curietemperatur / curie temperature: + 150°C
 Kabeldurchmesser / cable diameter [mm]: ≤ 8,0
 Lagertemperatur / storage temperature: -40°C ~ + 85°C
 Betriebstemp. / operating temperature: -25°C ~ +105°C

Freigabe erteilt / general release:	Kunde / customer			
			
Datum / date	Unterschrift / signature	SST	UL Update	05-03-16
	Würth Elektronik	LF	RoHS update	04-10-11
	LF	Op. Temp	03-01-22
Geprüft / checked	Kontrolliert / approved	JH	Neugestaltung	00-12-06
		Name	Änderung / modification	Datum / date

Würth Elektronik eiSos GmbH & Co. KG

D-74638 Waldenburg · Max-Eyth-Strasse 1 - 3 · Germany · Telefon (+49) (0) 7942 - 945 - 0 · Telefax (+49) (0) 7942 - 945 - 400
<http://www.we-online.com>

Spezifikation für Freigabe / specification for release

Kunde / customer : _____
 Artikelnummer / part number : **7427143** LF
 Bezeichnung : **RINGKERN MIT GEHÄUSE - KLAPPBAR**
 description : **SPLIT FERRITE RING WITH HOUSING**



DATUM / DATE : 2005-03-16

H Impedanzverlauf / impedance curve:

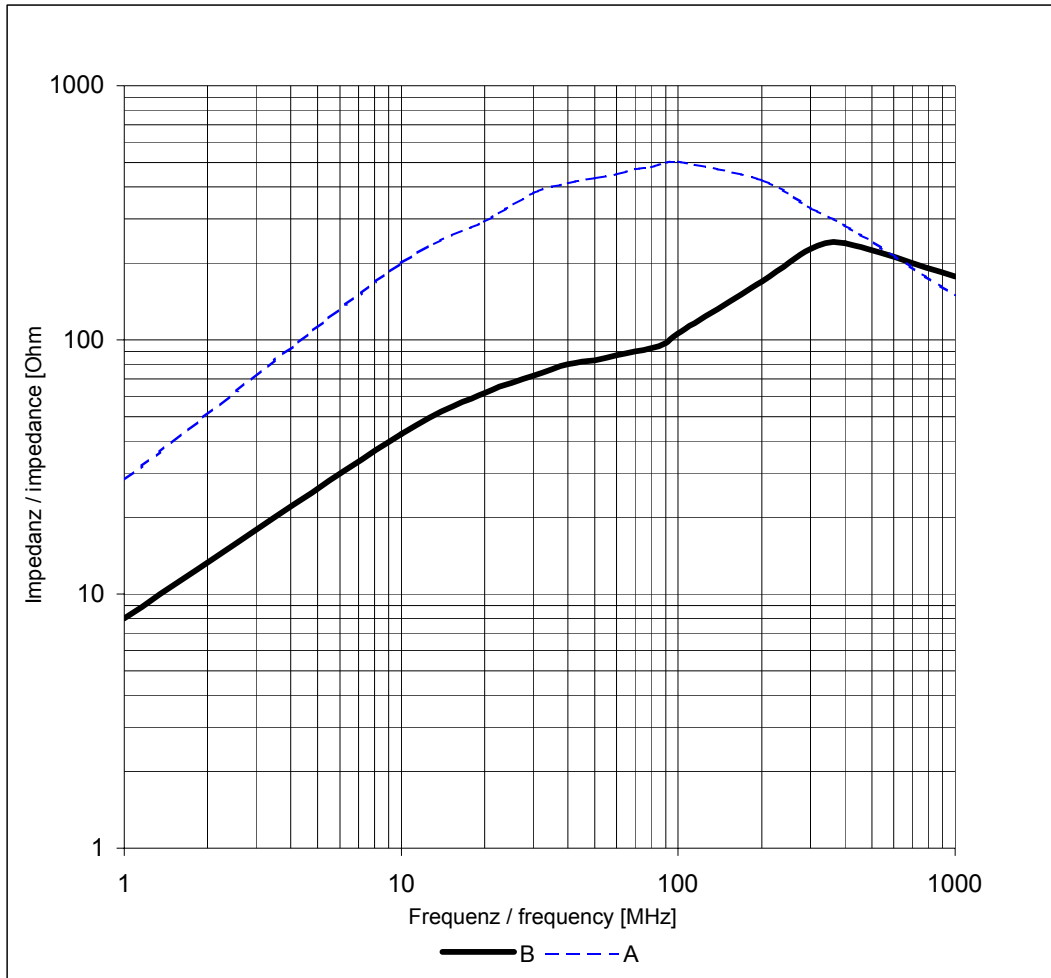

A: 2 x durch Bohrung Ferrit / 2 x times through ferrite
B: 1 x durch Bohrung Ferrit / 1 x times trough ferrite

Freigabe erteilt / general release:	Kunde / customer			
Datum / date	Unterschrift / signature	SST	UL Update	05-03-16
	Würth Elektronik	LF	RoHS update	04-10-11
		LF	Op.Temp	03-01-22
Geprüft / checked	Kontrolliert / approved	JH	Neugestaltung	00-12-06
		Name	Änderung / modification	Datum / date

This electronic component is designed and developed with the intention for use in general electronics equipments. Before incorporating the components into any equipments in the field such as aerospace, aviation, nuclear control, submarine, transportation, (automotive control, train control, ship control), transportation signal, disaster prevention, medical, public information network etc. where higher safety and reliability are especially required or if there is possibility of direct damage or injury to human body. In addition, even electronic component in general electronic equipments, when used in electrical circuits that require high safety, reliability functions or performance, the sufficient reliability evaluation-check for the safety must be performed before use. It is essential to give consideration when to install a protective circuit at the design stage.

Würth Elektronik eiSos GmbH & Co. KG

D-74638 Waldenburg · Max-Eyth-Strasse 1 - 3 · Germany · Telefon (+49) (0) 7942 - 945 - 0 · Telefax (+49) (0) 7942 - 945 - 400
<http://www.we-online.com>