

1 Form A Solid State Relay

Features

- Current Limit Protection
 - Isolation Test Voltage 5300 V_{RMS}
 - Typical R_{ON} 20 Ω
 - Load Voltage 350 V
 - Load Current 150 mA
 - High Surge Capability
 - Clean Bounce Free Switching
 - Low Power Consumption
 - High Reliability Monolithic output die
 - SMD Lead Available on Tape and Reel
-
- Lead-free component
 - Component in accordance to RoHS 2002/95/EC and WEEE 2002/96/EC

Agency Approvals

- UL1577, File No. E52744 System Code H or J, Double Protection
- CSA - Certification 093751
- BSI/BABT Cert. No. 7980
- FIMKO Approval

Applications

General Telecom Switching

- On/off Hook Control
- Ring Delay
- Dial Pulse
- Ground Start
- Ground Fault Protection

Instrumentation

Industrial Controls

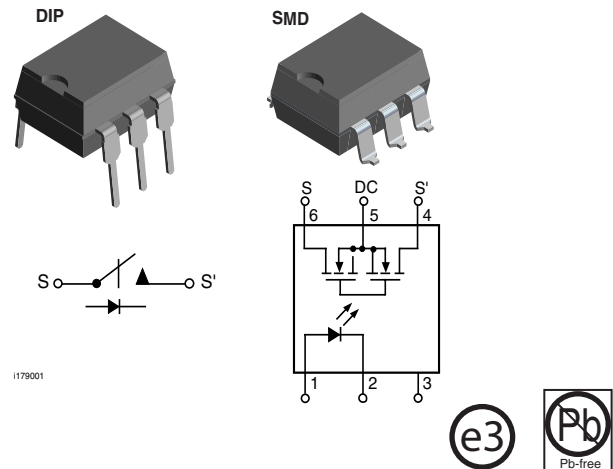

See "Solid State Relays" (Application Note 56)

Description

The LH1500 is robust, ideal for telecom and ground fault applications. It is a SPST normally open switch (1 Form A) that replaces electromechanical relays in many applications. It is constructed using a GaAlAs LED for actuation control and an integrated monolithic die for the switch output. The die, fabricated in a high-voltage dielectrically isolated technology, is comprised of a photodiode array, switch control circuitry and MOSFET switches. In addition, it employs current-limiting circuitry which meets FCC 68.302 and other regulatory voltage surge requirements when overvoltage protection is provided.

Order Information

Part	Remarks
LH1500AT	Thru Hole, DIP-6
LH1500AAB	SMD-6
LH1500AABTR	Tape and Reel, SMD-6

Absolute Maximum Ratings, $T_{amb} = 25\text{ }^{\circ}\text{C}$

Stresses in excess of the absolute Maximum Ratings can cause permanent damage to the device. Functional operation of the device is not implied at these or any other conditions in excess of those given in the operational sections of this document. Exposure to absolute Maximum Ratings for extended periods of time can adversely affect reliability.

SSR

Parameter	Test condition	Symbol	Value	Unit
SSR output power dissipation (continuous)		P_{diss}	550	mW
LED reverse voltage	$I_R \leq 10\text{ mA}$	V_R	8.0	V
LED continuous forward current		I_F	50	mA
DC or Peak AC load voltage	$I_L \leq 50\text{ mA}$	V_L	350	V
Continuous DC load current - bidirectional	$T_{amb} = 25\text{ }^{\circ}\text{C}$	I_L	150	mA
Continuous DC load current - unidirectional	$T_{amb} = 25\text{ }^{\circ}\text{C}$	I_L	250	mA
Ambient temperature range		T_{amb}	- 40 to + 85	$^{\circ}\text{C}$
Storage temperature range		T_{stg}	- 40 to + 150	$^{\circ}\text{C}$
Soldering temperature	$t = 10\text{ s max.}$	T_{sld}	260	$^{\circ}\text{C}$
Isolation test voltage (for 1.0 s)		V_{ISO}	5300	V_{RMS}
Isolation resistance	$V_{IO} = 500\text{ V}, T_{amb} = 25\text{ }^{\circ}\text{C}$	R_{IO}	$\geq 10^{12}$	Ω
	$V_{IO} = 500\text{ V}, T_{amb} = 100\text{ }^{\circ}\text{C}$	R_{IO}	$\geq 10^{11}$	Ω

Electrical Characteristics, $T_{amb} = 25\text{ }^{\circ}\text{C}$

Minimum and maximum values are testing requirements. Typical values are characteristics of the device and are the result of engineering evaluations. Typical values are for information only and are not part of the testing requirements.

Input

Parameter	Test condition	Symbol	Min	Typ.	Max	Unit
LED forward current, switch turn-on	$I_L = 100\text{ mA}, t = 10\text{ ms}$	I_{Fon}		0.9	2.0	mA
LED forward current, switch turn-off	$V_L = \pm 300\text{ V}$	I_{Foff}	0.2	0.8		mA
LED forward voltage	$I_F = 10\text{ mA}$	V_F	1.15	1.25	1.45	V

Output

Parameter	Test condition	Symbol	Min	Typ.	Max	Unit
ON-resistance, ac/dc: Pin 4 (\pm) to 6 (\pm)	$I_F = 5.0\text{ mA}, I_L = 50\text{ mA}$	R_{ON}		20	25	Ω
ON-resistance, dc: Pin 4, 6 (+) to 5 (-)	$I_F = 5.0\text{ mA}, I_L = 100\text{ mA}$	R_{ON}	3.0	4.6	6.25	Ω
Off-resistance	$I_F = 0\text{ mA}, V_L = \pm 100$	R_{OFF}	0.5	300		$G\Omega$
Current limit ac/dc: pin 4 (\pm) to 6 (\pm)	$I_F = 5.0, t = 5.0\text{ ms}, V_L = \pm 6.0\text{ V}$	I_{LMT}	230	255	370	mA
Off-state leakage current	$I_F = 0\text{ mA}, V_L = \pm 100\text{ V}$	I_O		0.32	200	nA
	$I_F = 0\text{ mA}, V_L = \pm 350\text{ V}$	I_O			1.0	μA
Output capacitance, Pin 4 to 6	$I_F = 0\text{ mA}, V_L = 1.0\text{ V}$	C_O		33		pF
	$I_F = 0\text{ mA}, V_L = 50\text{ V}$	C_O		10		pF
Switch offset	$I_F = 5.0\text{ mA}$	V_{OS}		0.2		μV

Transfer

Parameter	Test condition	Symbol	Min	Typ.	Max	Unit
Capacitance (input-output)	$V_{ISO} = 1.0\text{ V}$	C_{IO}		0.71		pF
Turn-on time	$I_F = 5.0\text{ mA}$, $I_L = 50\text{ mA}$	t_{on}		0.3	2.0	ms
Turn-off time	$I_F = 5.0\text{ mA}$, $I_L = 50\text{ mA}$	t_{off}		0.6	2.0	ms

Typical Characteristics ($T_{amb} = 25\text{ }^\circ\text{C}$ unless otherwise specified)

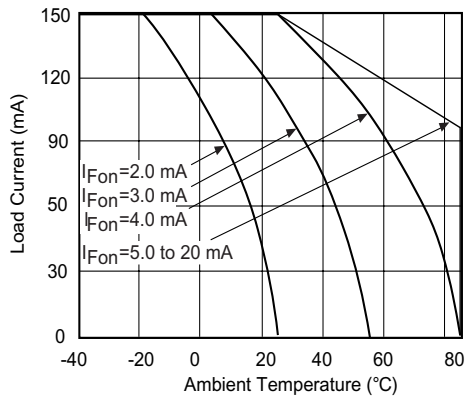

ih1500at_00

Figure 1. Recommended Operating Conditions

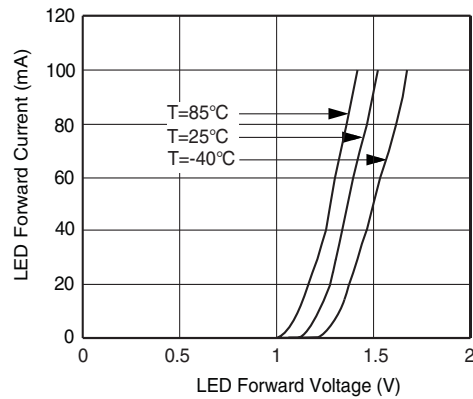

ih1500at_02

Figure 3. LED Forward Current vs. Forward Voltage

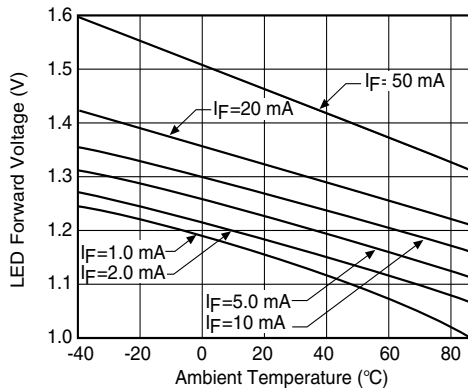

ih1500at_01

Figure 2. LED Voltage vs. Temperature

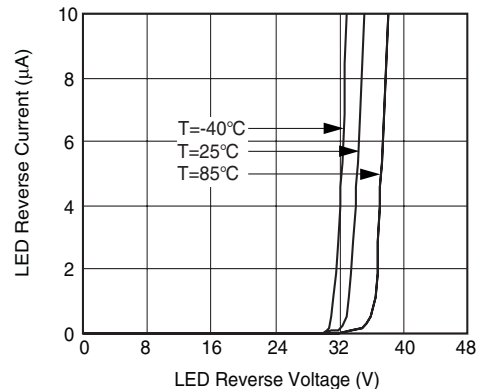

ih1500at_03

Figure 4. LED Reverse Current vs. LED Reverse Voltage

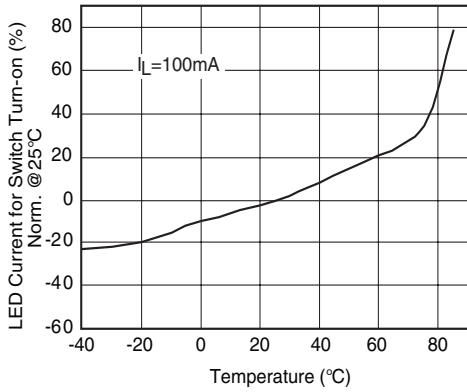

ih1500at_04

Figure 5. LED Current for Switch Turn-on vs. Temperature

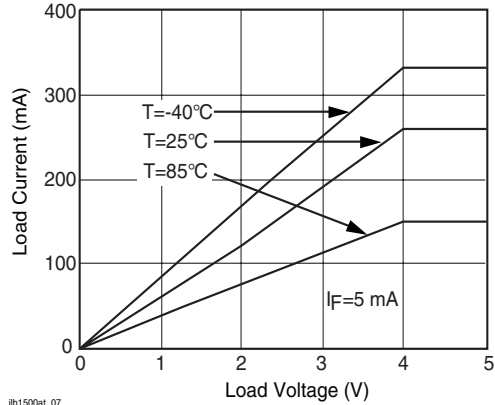

ih1500at_07

Figure 8. Load Current vs. Load Voltage

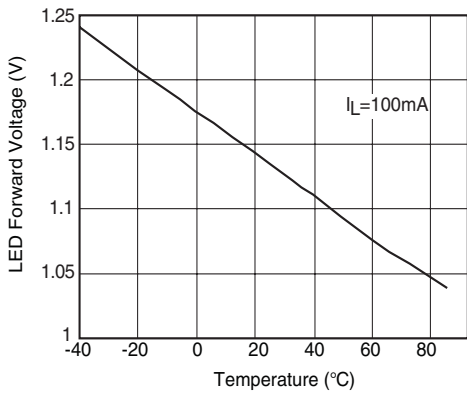

ih1500at_05

Figure 6. LED Dropout Voltage vs. Temperature

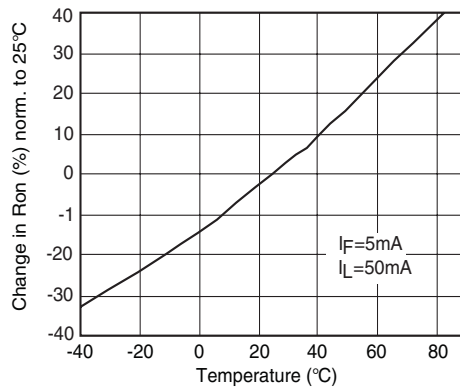

ih1500at_08

Figure 9. ON-Resistance vs. Temperature

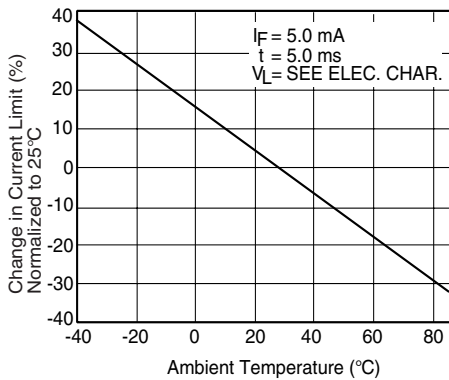

ih1500at_06

Figure 7. Current Limit vs. Temperature

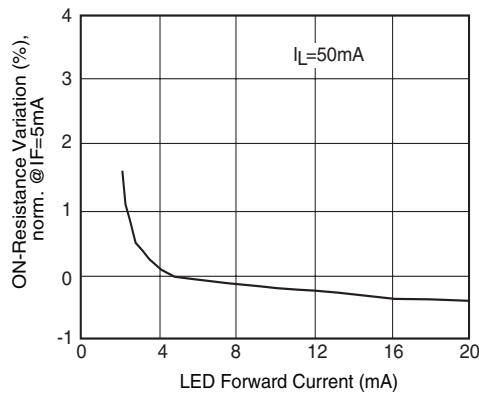

ih1500at_09

Figure 10. Variation in ON-Resistance vs. LED Current

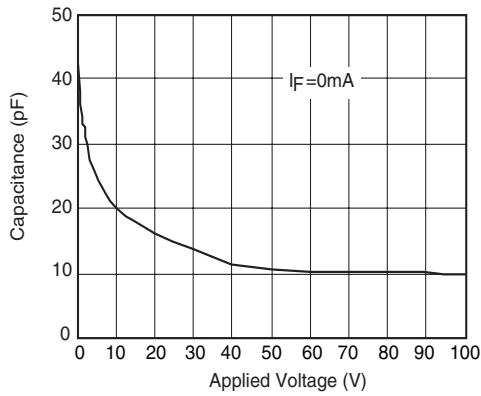

ih1500at_10

Figure 11. Switch Capacitance vs. Applied Voltage

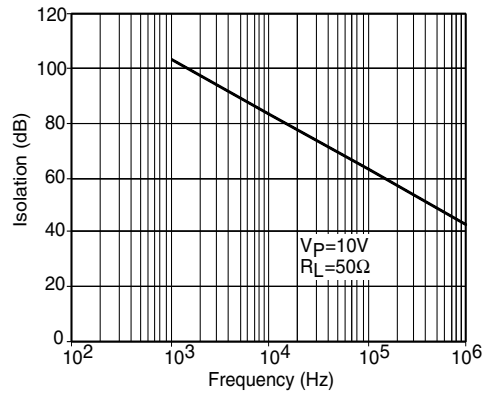

ih1500at_13

Figure 14. Output Isolation

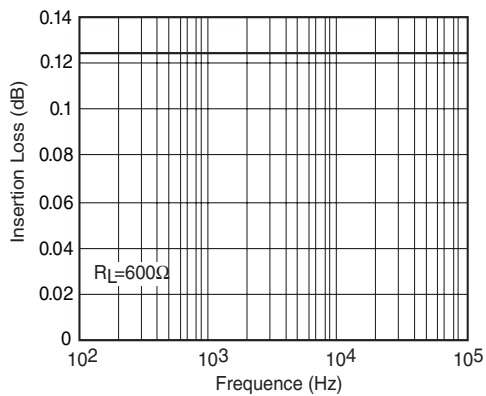

ih1500at_11

Figure 12. Insertion Loss vs. Frequency

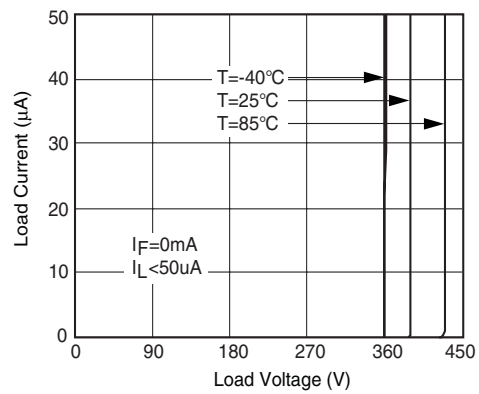

ih1500at_14

Figure 15. Switch Breakdown Voltage vs. Load Current

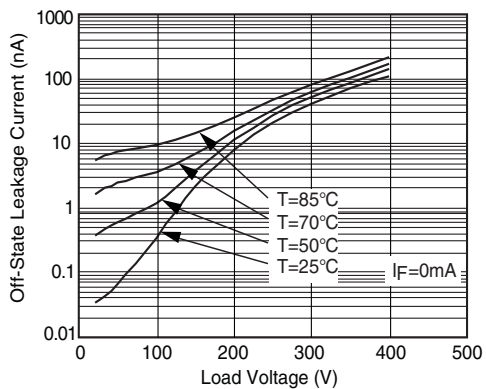

ih1500at_12

Figure 13. Leakage Current vs. Applied Voltage

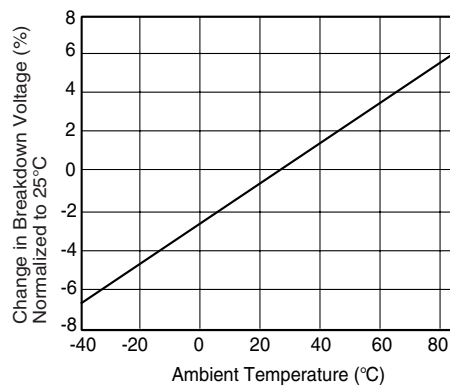

ih1500at_15

Figure 16. Switch Breakdown Voltage vs. Temperature

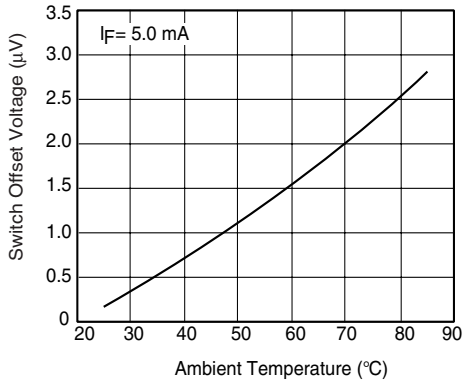

ih1500at_16

Figure 17. Switch Offset Voltage vs. Temperature

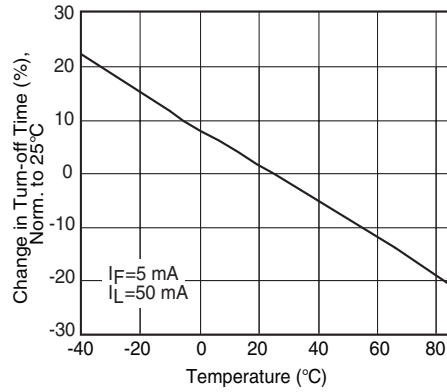

ih1500at_19

Figure 20. Turn-off Time vs. Temperature

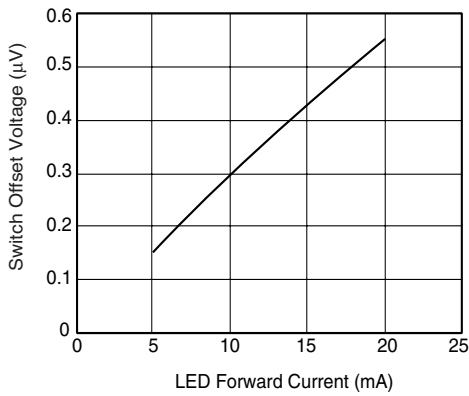

ih1500at_17

Figure 18. Switch Offset Voltage vs. LED Current

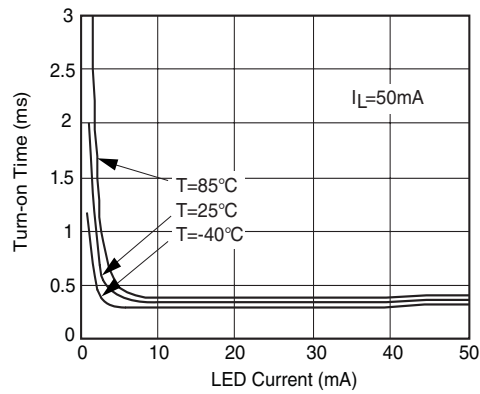

ih1500at_20

Figure 21. Turn-on Time vs. LED Current

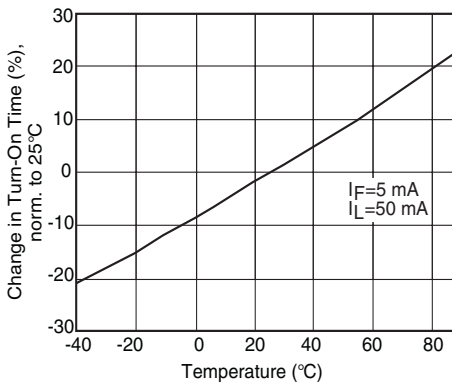

ih1500at_18

Figure 19. Turn-on Time vs. Temperature

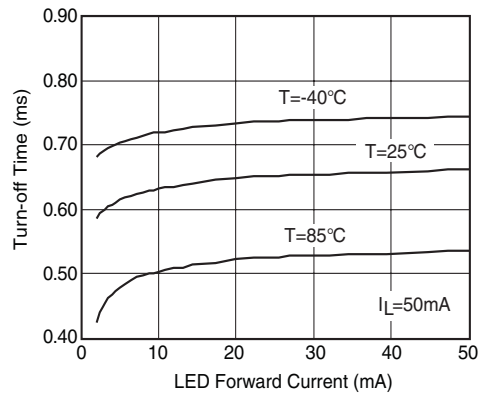

ih1500at_21

Figure 22. Turn-off Time vs. LED Current

Package Dimensions in Inches (mm)

DIP

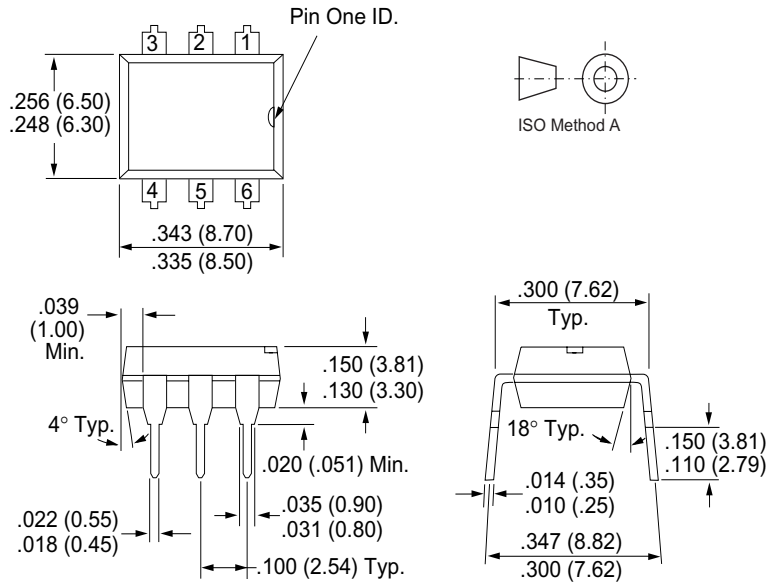

Package Dimensions in Inches (mm)

SMD

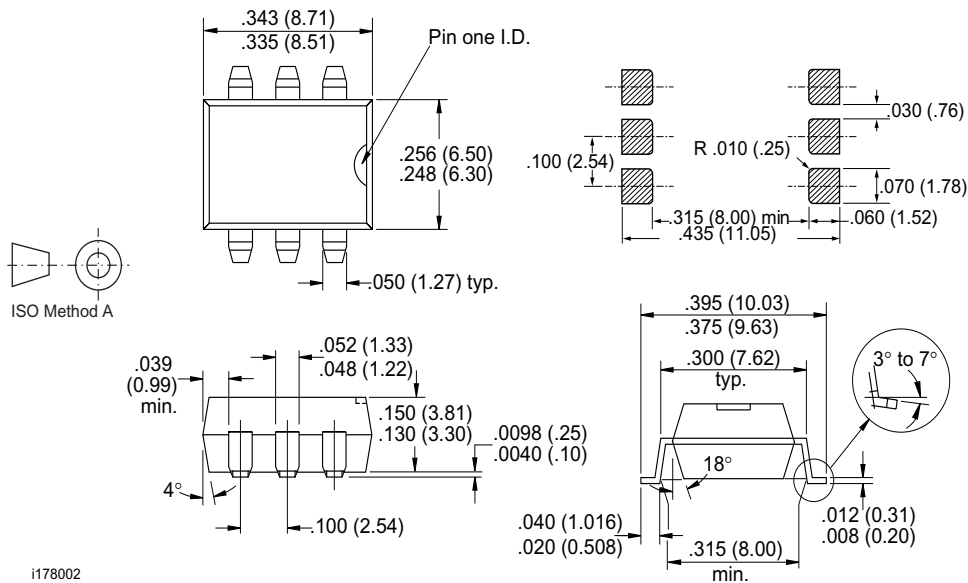

Ozone Depleting Substances Policy Statement

It is the policy of Vishay Semiconductor GmbH to

1. Meet all present and future national and international statutory requirements.
2. Regularly and continuously improve the performance of our products, processes, distribution and operating systems with respect to their impact on the health and safety of our employees and the public, as well as their impact on the environment.

It is particular concern to control or eliminate releases of those substances into the atmosphere which are known as ozone depleting substances (ODSs).

The Montreal Protocol (1987) and its London Amendments (1990) intend to severely restrict the use of ODSs and forbid their use within the next ten years. Various national and international initiatives are pressing for an earlier ban on these substances.

Vishay Semiconductor GmbH has been able to use its policy of continuous improvements to eliminate the use of ODSs listed in the following documents.

1. Annex A, B and list of transitional substances of the Montreal Protocol and the London Amendments respectively
2. Class I and II ozone depleting substances in the Clean Air Act Amendments of 1990 by the Environmental Protection Agency (EPA) in the USA
3. Council Decision 88/540/EEC and 91/690/EEC Annex A, B and C (transitional substances) respectively.

Vishay Semiconductor GmbH can certify that our semiconductors are not manufactured with ozone depleting substances and do not contain such substances.

We reserve the right to make changes to improve technical design
and may do so without further notice.

Parameters can vary in different applications. All operating parameters must be validated for each customer application by the customer. Should the buyer use Vishay Semiconductors products for any unintended or unauthorized application, the buyer shall indemnify Vishay Semiconductors against all claims, costs, damages, and expenses, arising out of, directly or indirectly, any claim of personal damage, injury or death associated with such unintended or unauthorized use.

Vishay Semiconductor GmbH, P.O.B. 3535, D-74025 Heilbronn, Germany
Telephone: 49 (0)7131 67 2831, Fax number: 49 (0)7131 67 2423