

Miniature Glass Passivated Single-Phase Surface Mount Bridge Rectifiers

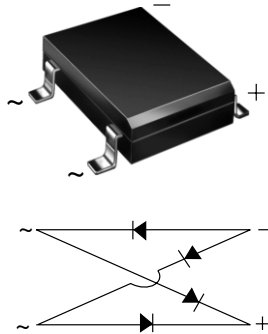

Case Style DFS

FEATURES

- UL Recognition, file number E54214
- Ideal for automated placement
- High surge current capability
- Meets MSL level 1, per J-STD-020C, LF max peak of 250 °C
- Solder Dip 260 °C, 40 seconds
- Component in accordance to RoHS 2002/95/EC and WEEE 2002/96/EC

TYPICAL APPLICATIONS

General purpose use in ac-to-dc bridge full wave rectification for SMPS, Lighting Ballaster, Adapter, Battery Charger, Home Appliances, Office Equipment, and Telecommunication applications.

MECHANICAL DATA

Case: DFS

Epoxy meets UL 94V-0 flammability rating

Terminals: Matte tin plated leads, solderable per J-STD-002B and JESD22-B102D

E3 suffix for commercial grade

Polarity: As marked on body

MAJOR RATINGS AND CHARACTERISTICS

$I_{F(AV)}$	1 A
V_{RRM}	50 V to 1000 V
I_{FSM}	50 A
I_R	5 μ A
V_F	1.1 V
T_j max.	150 °C

MAXIMUM RATINGS ($T_A = 25$ °C unless otherwise noted)

PARAMETER	SYMBOL	DF005S	DF01S	DF02S	DF04S	DF06S	DF08S	DF10S	UNIT
Device marking code		DF005S	DF01S	DF02S	DF04S	DF06S	DF08S	DF10S	
Maximum repetitive peak reverse voltage	V_{RRM}	50	100	200	400	600	800	1000	V
Maximum RMS voltage	V_{RMS}	35	70	140	280	420	560	700	V
Maximum DC blocking voltage	V_{DC}	50	100	200	400	600	800	1000	V
Maximum average forward output rectified current at $T_A = 40$ °C ⁽¹⁾	$I_{F(AV)}$	1.0							A
Peak forward surge current single half sine-wave superimposed on rated load	I_{FSM}	50							A
Rating for fusing ($t < 8.3$ ms)	I^2t	10							A ² sec
Operating junction and storage temperature range	T_J, T_{STG}	- 55 to + 150							°C

Note:

(1) Units mounted on P.C.B. with 0.51 x 0.51" (13 x 13 mm) copper pads

ELECTRICAL CHARACTERISTICS ($T_A = 25\text{ }^\circ\text{C}$ unless otherwise noted)										
PARAMETER	TEST CONDITIONS	SYMBOL	DF005S	DF01S	DF02S	DF04S	DF06S	DF08S	DF10S	UNIT
Maximum instantaneous forward voltage drop per diode	at 1.0 A	V_F				1.1				V
Maximum DC reverse current at rated DC blocking voltage per diode	$T_A = 25\text{ }^\circ\text{C}$ $T_A = 125\text{ }^\circ\text{C}$	I_R				5.0	500			μA
Typical junction capacitance per diode ⁽¹⁾		C_J				25				pF

Note:

(1) Measured at 1.0 MHz and applied reverse voltage of 4.0 Volts

THERMAL CHARACTERISTICS ($T_A = 25\text{ }^\circ\text{C}$ unless otherwise noted)										
PARAMETER	SYMBOL	DF005S	DF01S	DF02S	DF04S	DF06S	DF08S	DF10S	UNIT	
Typical thermal resistance ⁽¹⁾	$R_{\theta JA}$ $R_{\theta JL}$				40				$^\circ\text{C/W}$	
					15					

Note:

(1) Units mounted on P.C.B. with 0.51 x 0.51" (13 x 13 mm) copper pads

ORDERING INFORMATION				
PREFERRED P/N	UNIT WEIGHT (g)	PREFERRED PACKAGE CODE	BASE QUANTITY	DELIVERY MODE
DF06S-E3/45	0.399	45	50	Tube
DF06S-E3/77	0.399	77	1500	13" Diameter Paper Tape & Reel

RATINGS AND CHARACTERISTICS CURVES

($T_A = 25\text{ }^\circ\text{C}$ unless otherwise noted)

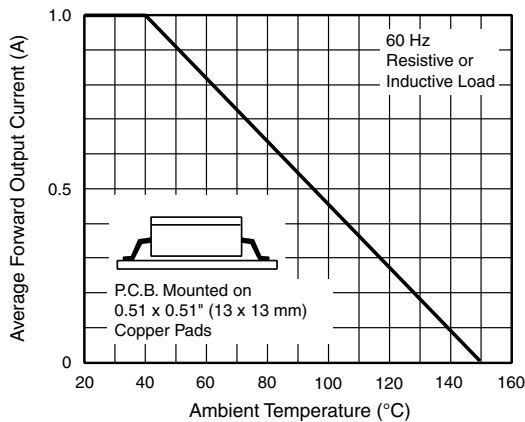

Figure 1. Derating Curve Output Rectified Current

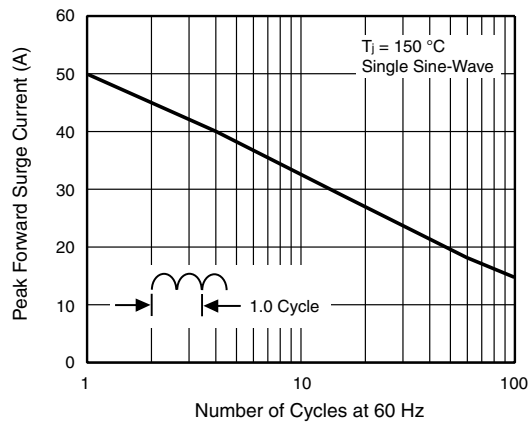

Figure 2. Maximum Non-Repetitive Peak Forward Surge Current Per Diode

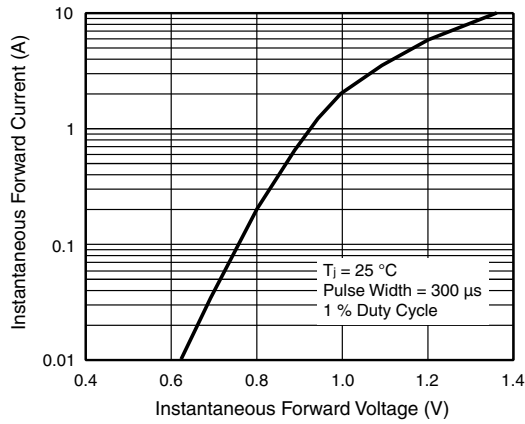

Figure 3. Typical Forward Characteristics Per Diode

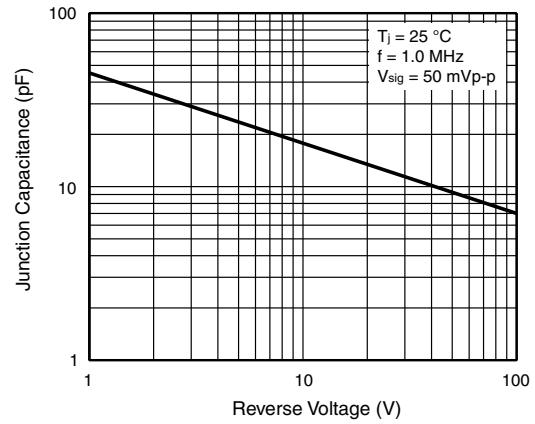

Figure 5. Typical Junction Capacitance Per Diode

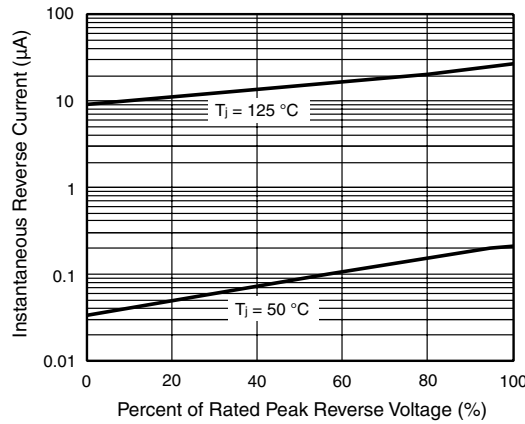

Figure 4. Typical Reverse Leakage Characteristics Per Diode

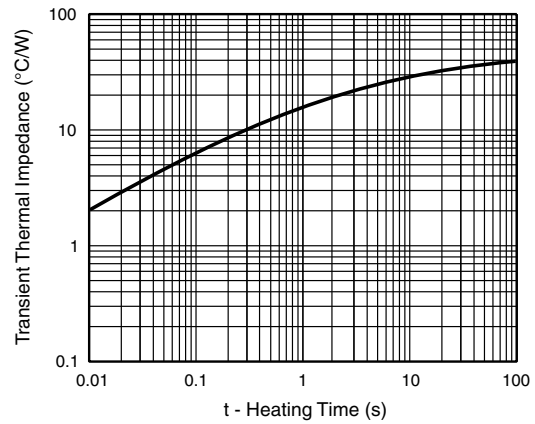
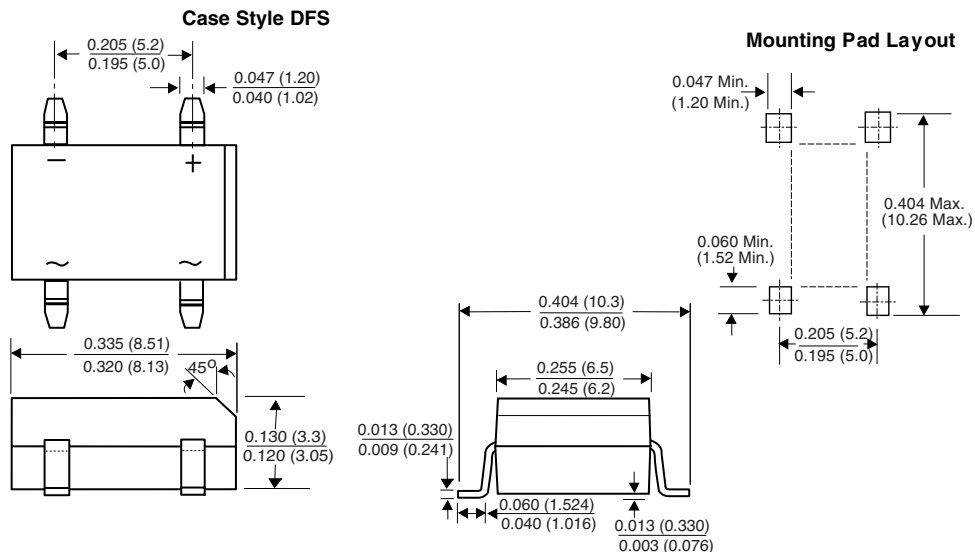

Figure 6. Typical Transient Thermal Impedance

PACKAGE OUTLINE DIMENSIONS in inches (millimeters)





Notice

Specifications of the products displayed herein are subject to change without notice. Vishay Intertechnology, Inc., or anyone on its behalf, assumes no responsibility or liability for any errors or inaccuracies.

Information contained herein is intended to provide a product description only. No license, express or implied, by estoppel or otherwise, to any intellectual property rights is granted by this document. Except as provided in Vishay's terms and conditions of sale for such products, Vishay assumes no liability whatsoever, and disclaims any express or implied warranty, relating to sale and/or use of Vishay products including liability or warranties relating to fitness for a particular purpose, merchantability, or infringement of any patent, copyright, or other intellectual property right.

The products shown herein are not designed for use in medical, life-saving, or life-sustaining applications. Customers using or selling these products for use in such applications do so at their own risk and agree to fully indemnify Vishay for any damages resulting from such improper use or sale.