

**QPW050/060 Series DC-DC Converter Power Modules:
36-75Vdc Input; 1.2Vdc to 3.3Vdc Output; 50A/60A Output Current**

RoHS Compliant



Applications

- Distributed power architectures
- Wireless Networks
- Access and Optical Network Equipment
- Enterprise Networks
- Latest generation IC's (DSP, FPGA, ASIC) and Microprocessor powered applications

Options

- Positive Remote On/Off logic
- Case ground pin (-H Baseplate option)
- Auto restart after fault shutdown

Description

The QPW-series dc-dc converters are a new generation of DC/DC power modules designed for maximum efficiency and power density. The QPW series provide up to 60A output current in an industry standard quarter brick. The converter incorporates synchronous rectification technology and innovative packaging techniques to achieve ultra high efficiency reaching 93% at 3.3V full load. The ultra high efficiency of this converter leads to lower power dissipation such that for most applications a heat sink is not required. The QPW series power modules are isolated dc-dc converters that operate over a wide input voltage range of 36 to 75 Vdc and provide single precisely regulated output. The output is fully isolated from the input, allowing versatile polarity configurations and grounding connections.

Features

- Compliant to RoHS EU Directive 2002/95/EC (-Z versions)
- Compliant to ROHS EU Directive 2002/95/EC with lead solder exemption (non-Z versions)
- Delivers up to 60A output current
- Improved Thermal Performance: 30A at 70°C at 1m/s (200LFM) for 3.3V_o
- High power density: 119W/in³
- High efficiency – 93% at 3.3V full load
- Low output voltage- supports migration to future IC supply voltages down to 1.0V
- Industry standard Quarter brick: 57.9 mm x 36.8 mm x 10.6 mm (2.28 in x 1.45 in x 0.42 in)
- Single tightly regulated output
- 2:1 input voltage range
- Constant Switching frequency
- Negative Remote On/Off logic
- Output overcurrent/voltage/temperature protection
- Output Voltage adjustment (±10%)
- Wide operating temperature range (-40°C to 85°C)
- Meets the voltage insulation requirements for ETSI 300-132-2 and complies with and is licensed for Basic Insulation rating per EN60950-1
- CE mark meets 73/23/EEC and 93/68/EEC directives[§]
- *UL*^{*} 60950-1 Recognized, *CSA*[†] C22.2 No. 60950-1-03 Certified, and *VDE*[‡] 0805:2001-12 (EN60950-1) Licensed
- ISO** 9001 certified manufacturing facilities

* *UL* is a registered trademark of Underwriters Laboratories, Inc.

† *CSA* is a registered trademark of Canadian Standards Association.

‡ *VDE* is a trademark of Verband Deutscher Elektrotechniker e.V.

** ISO is a registered trademark of the International Organization of Standards

Absolute Maximum Ratings

Stresses in excess of the absolute maximum ratings can cause permanent damage to the device. These are absolute stress ratings only, functional operation of the device is not implied at these or any other conditions in excess of those given in the operations sections of the data sheet. Exposure to absolute maximum ratings for extended periods can adversely affect the device reliability.

Parameter	Device	Symbol	Min	Max	Unit
Input Voltage					
Continuous		V_{IN}	-0.3	80	Vdc
Transient (100ms)		$V_{IN,trans}$	-0.3	100	Vdc
Operating Ambient Temperature (see Thermal Considerations section)	All	T_A	-40	85	°C
Storage Temperature	All	T_{stg}	-55	125	°C
I/O Isolation Voltage (100% factory Hi-Pot tested)	All	—	—	1500	Vdc

Electrical Specifications

Unless otherwise indicated, specifications apply over all operating input voltage, resistive load, and temperature conditions.

Parameter	Device	Symbol	Min	Typ	Max	Unit
Operating Input Voltage		V_{IN}	36	48	75	Vdc
Maximum Input Current ($V_{IN}=0V$ to 60V, $I_O=I_{O,max}$)		$I_{IN,max}$			6	Adc
Inrush Transient	All	I^2t			1	A ² s
Input Reflected Ripple Current, peak-to-peak (5Hz to 20MHz, 12μH source impedance; $V_{IN}=0V$ to 75V, $I_O=I_{O,max}$; see Figure 31)	All			7		mAp-p
Input Ripple Rejection (120Hz)	All			50		dB

CAUTION: This power module is not internally fused. An input line fuse must always be used.

This power module can be used in a wide variety of applications, ranging from simple standalone operation to an integrated part of a sophisticated power architecture. To preserve maximum flexibility, internal fusing is not included, however, to achieve maximum safety and system protection, always use an input line fuse. The safety agencies require a fast-acting fuse with a maximum rating of 15A (see Safety Considerations section). Based on the information provided in this data sheet on inrush energy and maximum dc input current, the same type of fuse with a lower rating can be used. Refer to the fuse manufacturer's data sheet for further information.

Electrical Specifications (continued)

Parameter	Device	Symbol	Min	Typ	Max	Unit
Output Voltage Set-point ($V_{IN}=V_{IN,nom}$, $I_O=I_{O,max}$, $T_c=25^\circ\text{C}$)	3.3V 2.5V 1.8V 1.5V 1.2V	$V_{O,set}$	3.24 2.45 1.77 1.47 1.18	3.30 2.25 1.80 1.50 1.20	3.36 2.55 1.83 1.53 1.22	V_{dc}
Output Voltage (Over all operating input voltage, resistive load, and temperature conditions until end of life)	3.3V 2.5V 1.8V 1.5V 1.2V	V_O	3.20 2.42 1.74 1.44 1.15	—	3.40 2.57 1.86 1.56 1.25	V_{dc}
Output Regulation Line ($V_{IN}=V_{IN,min}$ to $V_{IN,max}$) Load ($I_O=I_{O,min}$ to $I_{O,max}$) Temperature ($T_c = -40^\circ\text{C}$ to $+85^\circ\text{C}$)	All All All		— — —	0.05 0.05 15	0.2 0.2 50	% V_O % V_O mV
Output Ripple and Noise on nominal output ($V_{IN}=V_{IN,nom}$ and $I_O=I_{O,min}$ to $I_{O,max}$) RMS (5Hz to 20MHz bandwidth) Peak-to-Peak (5Hz to 20MHz bandwidth)	All All		— —	— —	30 100	mV _{rms} mV _{pk-pk}
External Capacitance	All	$C_{O,max}$	—	—		μF
Output Current	3.3V 2.5V – 1.2V	I_O I_O	0 0		50 60	A _{dc} A _{dc}
Output Current Limit Inception	3.3V 2.5V – 1.2V	$I_{O,lim}$ $I_{O,lim}$	— —	58 69	— —	A _{dc} A _{dc}
Output Short-Circuit Current ($V_O \leq 250\text{mV}$) (Hiccup Mode)		$I_{O,s/c}$ $I_{O,s/c}$	— —		— —	A _{rms} A _{rms}
Efficiency $V_{IN}=V_{IN,nom}$, $T_c=25^\circ\text{C}$ $I_O=I_{O,max}$, $V_O=V_{O,set}$	3.3V 2.5V 1.8V 1.5V 1.2V	η η η η η	— — — — —	93 91 89 87 85	— — — — —	% % % % %
Switching Frequency		f_{sw}	—	300	—	kHz
Dynamic Load Response ($\Delta I_O/\Delta t=1\text{A}/10\mu\text{s}$; $V_{in}=V_{in,nom}$; $T_c=25^\circ\text{C}$; Tested with a 10 μF aluminum and a 1.0 μF ceramic capacitor across the load.) Load Change from $I_O= 50\%$ to 75% of $I_{O,max}$: Peak Deviation Settling Time ($V_O < 10\%$ peak deviation) Load Change from $I_O= 75\%$ to 50% of $I_{O,max}$: Peak Deviation Settling Time ($V_O < 10\%$ peak deviation)	All	V_{pk} t_s V_{pk} t_s	— — — —	4 200 4 200	— — — —	% $V_{O,set}$ μs % $V_{O,set}$ μs

Isolation Specifications

Parameter	Symbol	Min	Typ	Max	Unit
Isolation Capacitance	C_{iso}	—	2700	—	pF
Isolation Resistance	R_{iso}	10	—	—	MΩ

General Specifications

Parameter	Device	Min	Typ	Max	Unit
Calculated MTBF ($I_o=80\%$ of $I_{o,max}$, $T_c=40^\circ\text{C}$, airflow=1m/s(200LFM))	All	1,204,000			Hours
Weight		—	42 (1.48)	—	g (oz.)

Feature Specifications

Unless otherwise indicated, specifications apply over all operating input voltage, resistive load, and temperature conditions. See Feature Descriptions for additional information.

Parameter	Device	Symbol	Min	Typ	Max	Unit
Remote On/Off Signal Interface ($V_{IN}=V_{IN, min}$ to $V_{IN, max}$; open collector or equivalent, Signal referenced to V_{IN} -terminal) Negative Logic: device code suffix "1" Logic Low = module On, Logic High = module Off Positive Logic: No device code suffix required Logic Low = module Off, Logic High = module On Logic Low Specification Remote On/Off Current – Logic Low On/Off Voltage: Logic Low Logic High – (Typ = Open Collector) Logic High maximum allowable leakage current	All	$I_{on/off}$	—	0.15	1.0	mA
Turn-On Delay and Rise Times ($I_O=I_{O, max}$) T_{delay} = Time until $V_O = 10\%$ of $V_{O, set}$ from either application of V_{in} with Remote On/Off set to On or operation of Remote On/Off from Off to On with V_{in} already applied for at least one second. T_{rise} = time for V_O to rise from 10% of $V_{O, set}$ to 90% of $V_{O, set}$.	3.3V	T_{delay}	—	2.5	—	ms
		T_{rise}	—	12	—	ms
	2.5V – 1.2V	T_{delay}	—	2.5	—	ms
		T_{rise}	—	1.5	—	ms
Output Voltage Adjustment (See Feature Descriptions): Output Voltage Remote-sense Range Output Voltage Set-point Adjustment Range (trim)		V_{sense}	— 90	— —	10 110	$\%V_{O, nom}$ $\%V_{O, nom}$
Output Overvoltage Protection	3.3V 2.5V 1.8V 1.5V 1.2V	$V_{O, limit}$	4.0 3.0 2.1 1.8 1.5	— — — — —	4.9 3.4 2.4 2.2 1.8	V V V V V
Overtemperature Protection (See Feature Descriptions)	All	T_{ref}	—	110	—	°C
Input Undervoltage Lockout		$V_{IN, UVLO}$				
Turn-on Threshold	R		—	34.5	36	V
Turn-off Threshold	R		30	32	—	V

Characteristic Curves

The following figures provide typical characteristics for the QPW050A0F (3.3V, 50A) at 25°C. The figures are identical for either positive or negative Remote On/Off logic.

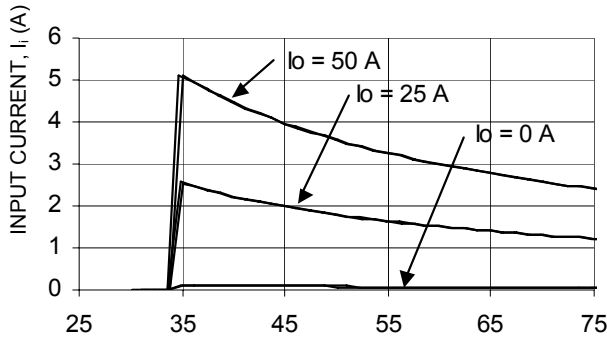

Figure 1. Typical Input Characteristic at Room Temperature.

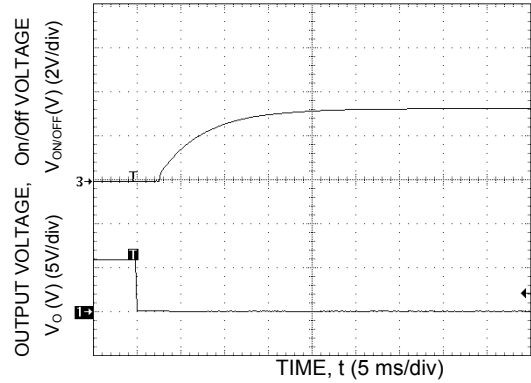

Figure 4. Typical Start-Up Using Remote On/Off, negative logic version shown.

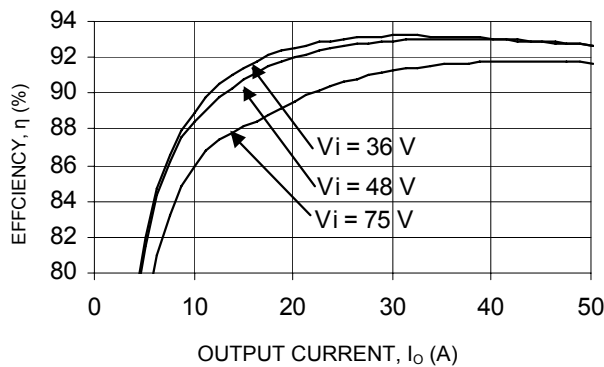

Figure 2. Typical Converter Efficiency Vs. Output current at Room Temperature.

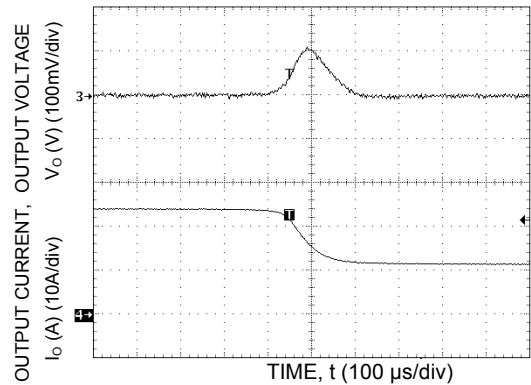

Figure 5. Typical Transient Response to Step change in Load from 50% to 25% of Full Load at Room Temperature and 48 Vdc Input.

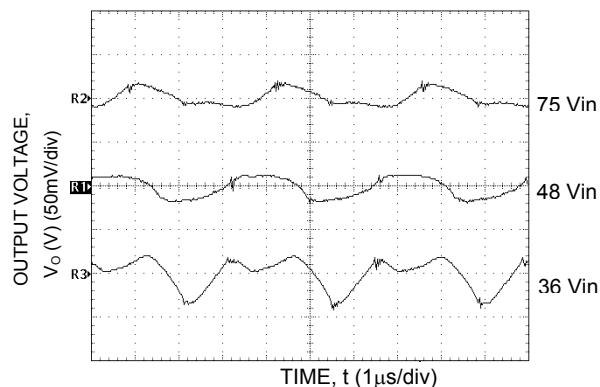

Figure 3. Typical Output Ripple and Noise at Room Temperature and $I_o = I_{o, max}$.

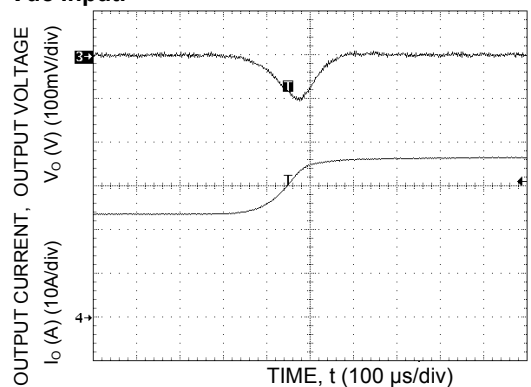

Figure 6. Typical Transient Response to Step change in Load from 50% to 75% of Full Load at Room Temperature and 48 Vdc Input.

Characteristic Curves

The following figures provide typical characteristics for the QPW060A0G (2.5V, 60A) at 25°C. The figures are identical for either positive or negative Remote On/Off logic.

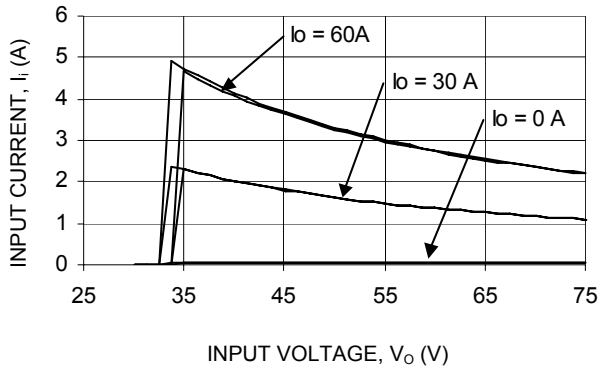

Figure 7. Typical Input Characteristic at Room Temperature.

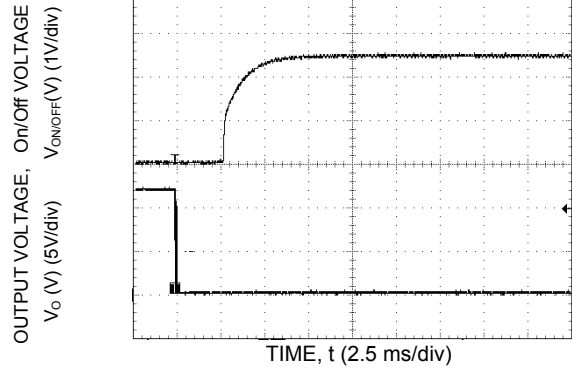

Figure 10. Typical Start-Up Using Remote On/Off, negative logic version shown.

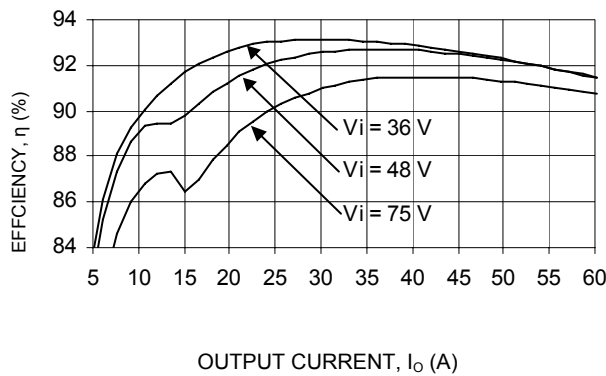

Figure 8. Typical Converter Efficiency Vs. Output current at Room Temperature.

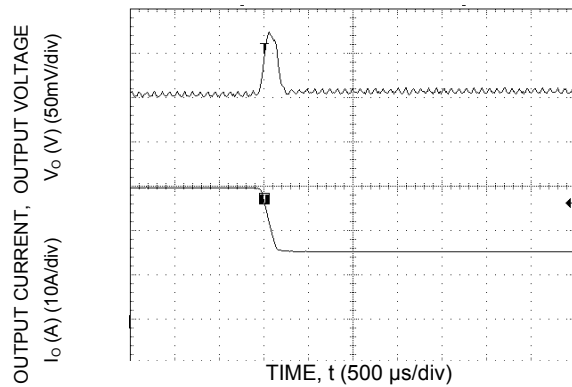

Figure 11. Typical Transient Response to Step change in Load from 50% to 25% of Full Load at Room Temperature and 48 Vdc Input.

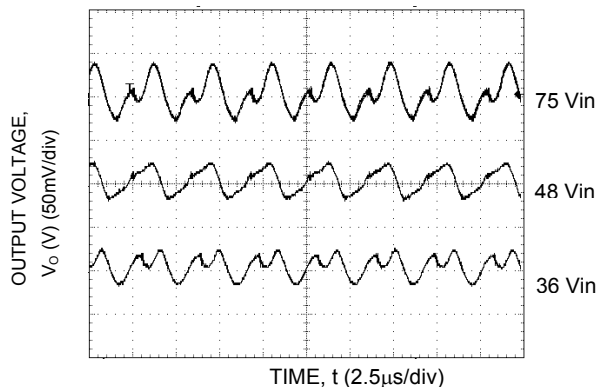

Figure 9. Typical Output Ripple and Noise at Room Temperature and $I_o = I_{o, max}$.

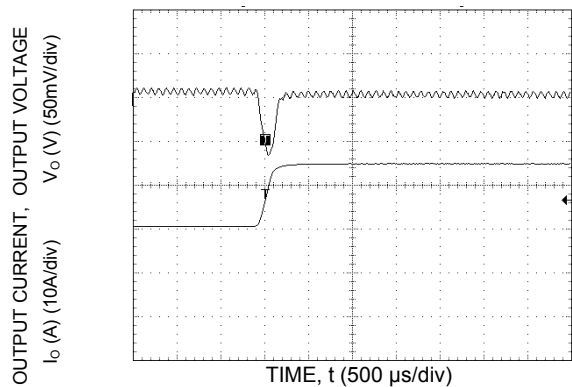

Figure 12. Typical Transient Response to Step change in Load from 50% to 75% of Full Load at Room Temperature and 48 Vdc Input.

Characteristic Curves

The following figures provide typical characteristics for the QPW060A0Y (1.8V, 60A) at 25°C. The figures are identical for either positive or negative Remote On/Off logic.

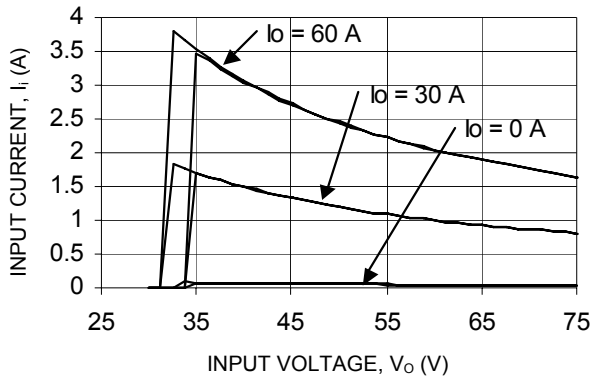

Figure 13. Typical Input Characteristic at Room Temperature.

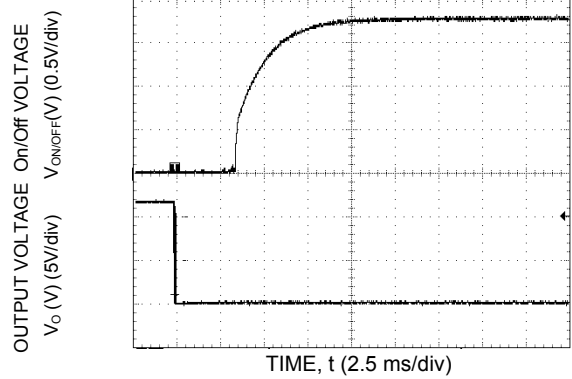

Figure 16. Typical Start-Up Using Remote On/Off, negative logic version shown.

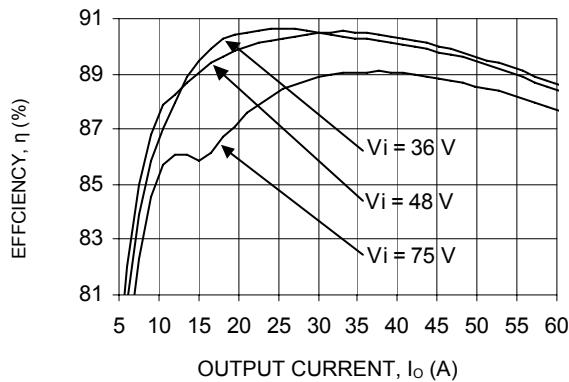

Figure 14. Typical Converter Efficiency Vs. Output current at Room Temperature.

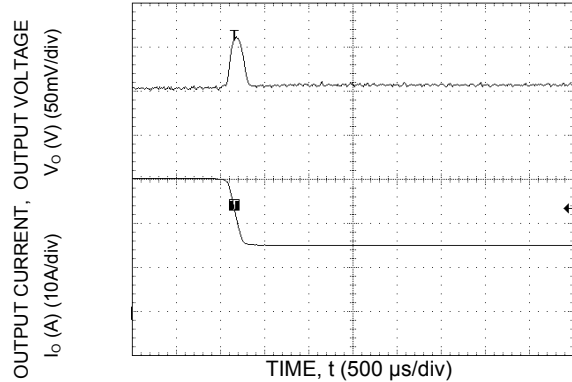

Figure 17. Typical Transient Response to Step change in Load from 50% to 25% of Full Load at Room Temperature and 48 Vdc Input.

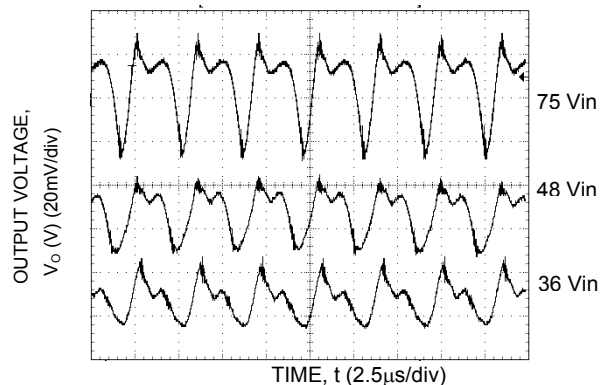

Figure 15. Typical Output Ripple and Noise at Room Temperature and $I_o = I_{o, max}$.

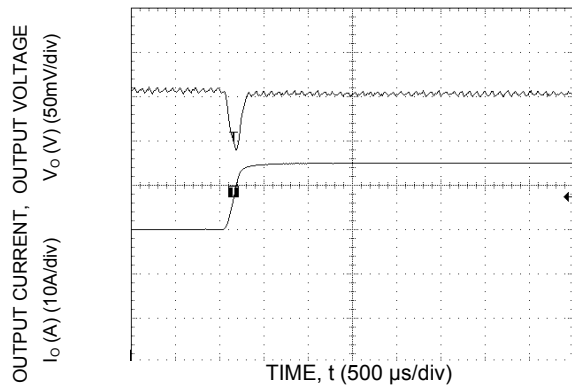

Figure 18. Typical Transient Response to Step change in Load from 50% to 75% of Full Load at Room Temperature and 48 Vdc Input.

Characteristic Curves

The following figures provide typical characteristics for the QPW060A0M (1.5V, 60A) at 25°C. The figures are identical for either positive or negative Remote On/Off logic.

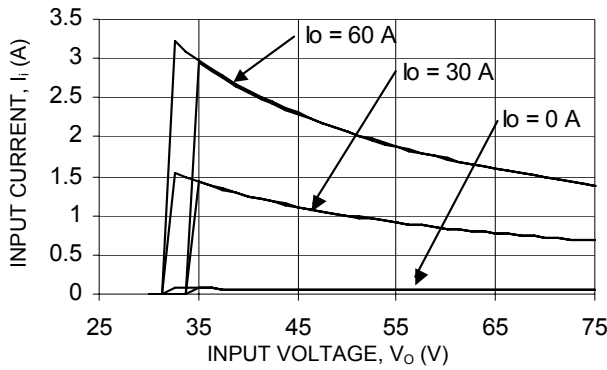

Figure 19. Typical Input Characteristic at Room Temperature.

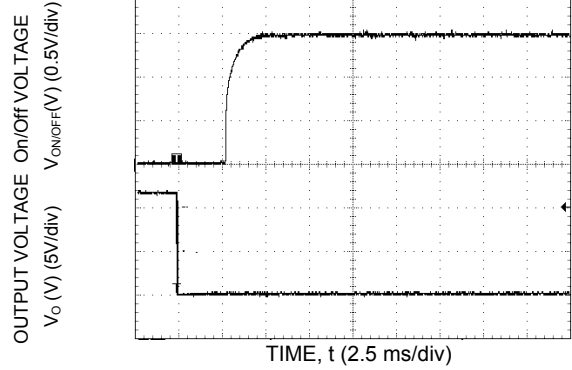

Figure 22. Typical Start-Up Using Remote On/Off, negative logic version shown.

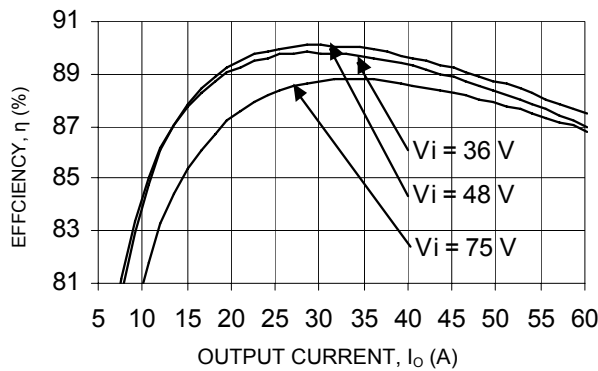

Figure 20. Typical Converter Efficiency Vs. Output current at Room Temperature.

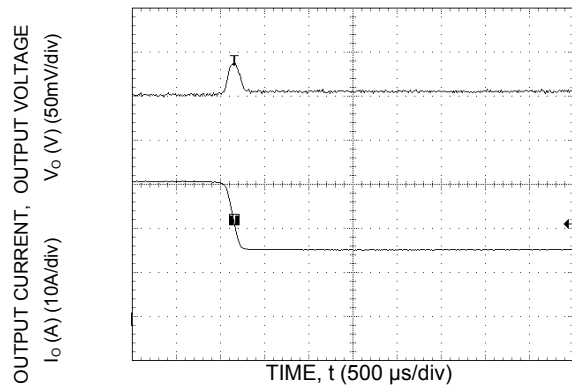

Figure 23. Typical Transient Response to Step change in Load from 50% to 25% of Full Load at Room Temperature and 48 Vdc Input.

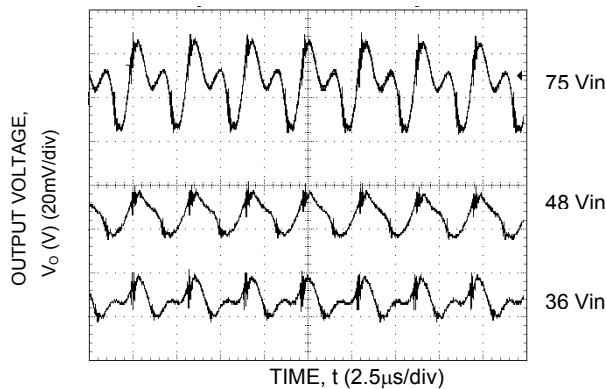

Figure 21. Typical Output Ripple and Noise at Room Temperature and $I_o = I_{o, max}$.

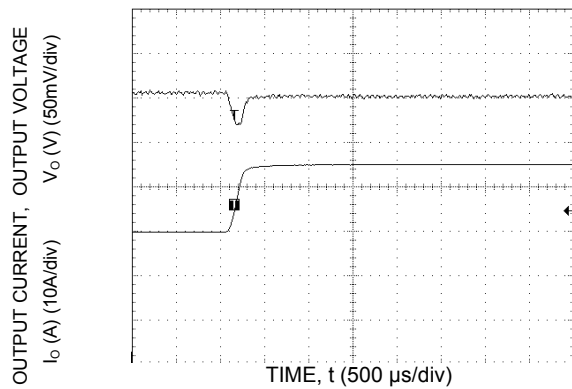

Figure 24. Typical Transient Response to Step change in Load from 50% to 75% of Full Load at Room Temperature and 48 Vdc Input.

Characteristic Curves

The following figures provide typical characteristics for the QPW060A0P (1.2V, 60A) at 25°C. The figures are identical for either positive or negative Remote On/Off logic.

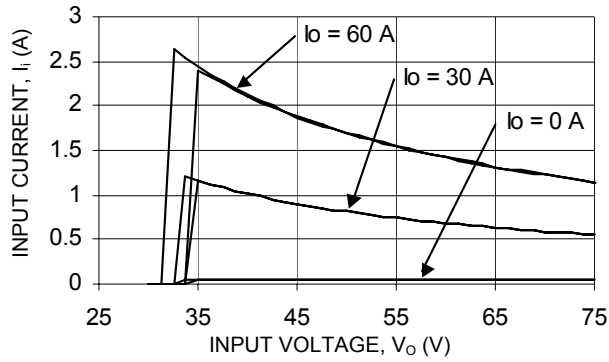

Figure 25. Typical Input Characteristic at Room Temperature.

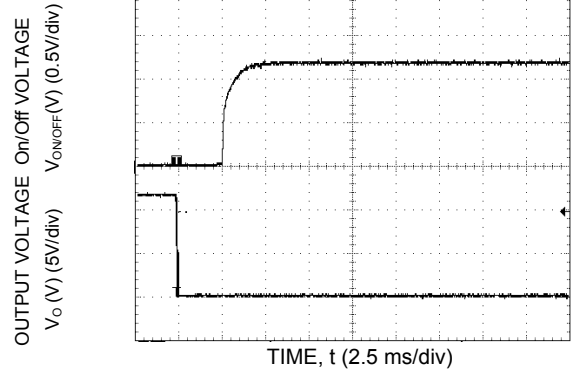

Figure 28. Typical Start-Up Using Remote On/Off, negative logic version shown.

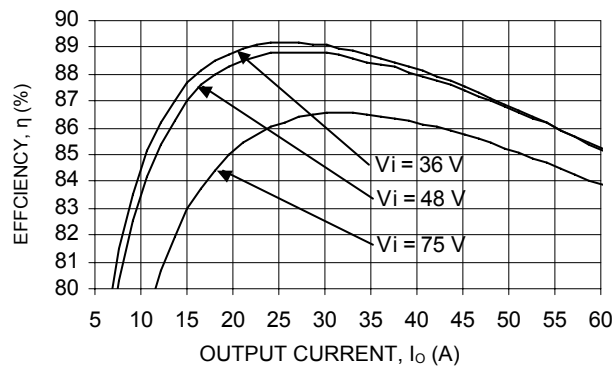

Figure 26. Typical Converter Efficiency Vs. Output current at Room Temperature.

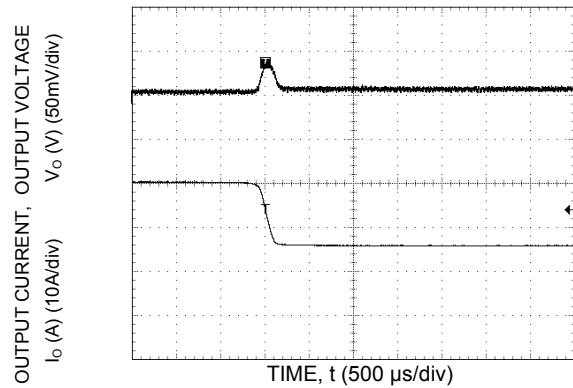

Figure 29. Typical Transient Response to Step change in Load from 50% to 25% of Full Load at Room Temperature and 48 Vdc Input.

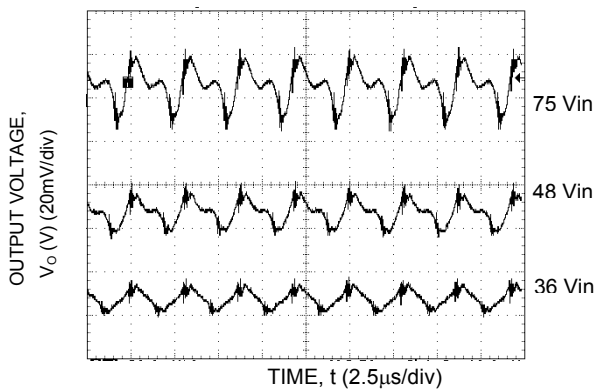

Figure 27. Typical Output Ripple and Noise at Room Temperature and $I_o = I_{o, max}$.

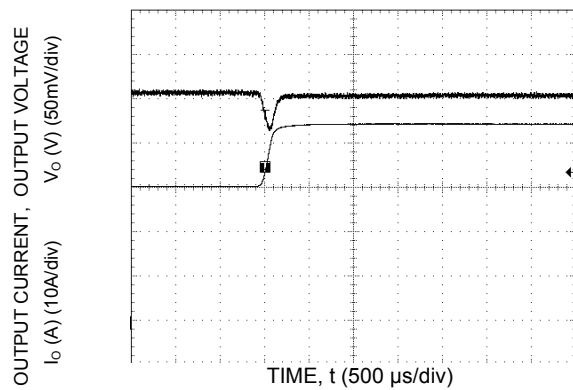
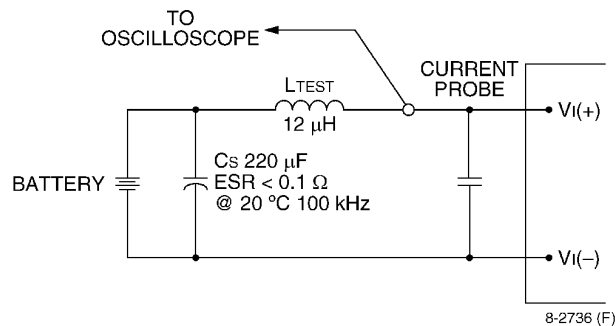

Figure 30. Typical Transient Response to Step change in Load from 50% to 75% of Full Load at Room Temperature and 48 Vdc Input.

Test Configurations



Note: Measure input reflected-ripple current with a simulated source inductance (LTEST) of 12 µH. Capacitor CS offsets possible battery impedance. Measure current as shown above.

Figure 31. Input Reflected Ripple Current Test Setup.

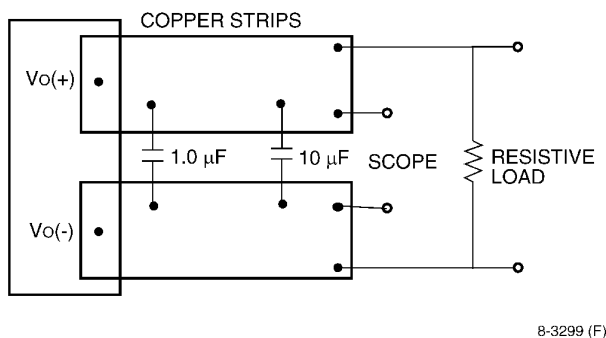

Note: Use a 1.0 µF ceramic capacitor and a 10 µF aluminum or tantalum capacitor. Scope measurement should be made using a BNC socket. Position the load between 51 mm and 76 mm (2 in. and 3 in.) from the module.

Figure 32. Output Ripple and Noise Test Setup.

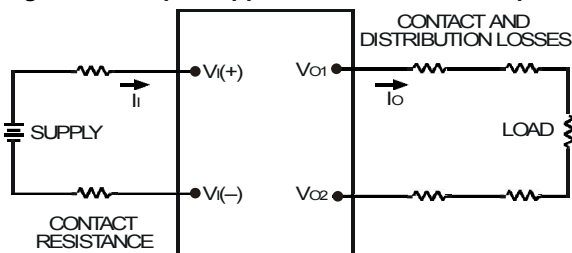

Note: All measurements are taken at the module terminals. When socketing, place Kelvin connections at module terminals to avoid measurement errors due to socket contact resistance.

$$\eta = \left(\frac{[V_{O(+)} - V_{O(-)}] I_o}{[V_{I(+)} - V_{I(-)}] I_i} \right) \times 100 \%$$

Figure 33. Output Voltage and Efficiency Test Setup.

Design Considerations

Input Source Impedance

The power module should be connected to a low ac-impedance source. A highly inductive source impedance can affect the stability of the power module. For the test configuration in Figure 31, a 100µF electrolytic capacitor (ESR<0.7Ω at 100kHz), mounted close to the power module helps ensure the stability of the unit. Consult the factory for further application guidelines.

Output Capacitance

High output current transient rate of change (high di/dt) loads may require high values of output capacitance to supply the instantaneous energy requirement to the load. To minimize the output voltage transient drop during this transient, low E.S.R. (equivalent series resistance) capacitors may be required, since a high E.S.R. will produce a correspondingly higher voltage drop during the current transient.

Output capacitance and load impedance interact with the power module's output voltage regulation control system and may produce an 'unstable' output condition for the required values of capacitance and E.S.R.. Minimum and maximum values of output capacitance and of the capacitor's associated E.S.R. may be dictated, depending on the module's control system.

The process of determining the acceptable values of capacitance and E.S.R. is complex and is load-dependant. Lineage Power provides Web-based tools to assist the power module end-user in appraising and adjusting the effect of various load conditions and output capacitances on specific power modules for various load conditions.

Safety Considerations

For safety-agency approval of the system in which the power module is used, the power module must be installed in compliance with the spacing and separation requirements of the end-use safety agency standard, i.e., UL 60950-1-3, CSA C22.2 No. 60950-00, and VDE 0805:2001-12 (IEC60950-1).

For the converter output to be considered meeting the requirements of safety extra-low voltage (SELV), the input must meet SELV requirements.

If the input source is non-SELV (ELV or a hazardous voltage greater than 60 Vdc and less than or equal to 75Vdc), for the module's output to be considered as meeting the requirements for safety extra-low voltage (SELV), all of the following must be true:

Safety Considerations (continued)

- The input source is to be provided with reinforced insulation from any other hazardous voltages, including the ac mains.
- One V_{IN} pin and one V_{OUT} pin are to be grounded, or both the input and output pins are to be kept floating.
- The input pins of the module are not operator accessible.
- Another SELV reliability test is conducted on the whole system (combination of supply source and subject module), as required by the safety agencies, to verify that under a single fault, hazardous voltages do not appear at the module's output.

Note: Do not ground either of the input pins of the module without grounding one of the output pins. This may allow a non-SELV voltage to appear between the output pins and ground.

The power module has extra-low voltage (ELV) outputs when all inputs are ELV.

For input voltages exceeding –60 Vdc but less than or equal to –75 Vdc, these converters have been evaluated to the applicable requirements of BASIC INSULATION between secondary DC MAINS DISTRIBUTION input (classified as TNV-2 in Europe) and unearthed SELV outputs.

The input to these units is to be provided with a maximum 15A fast-acting (or time-delay) fuse in the unearthed lead.

Feature Descriptions

Overcurrent Protection

To provide protection in a fault output overload condition, the module is equipped with internal current-limiting circuitry and can endure current limit for few seconds. If overcurrent persists for few seconds, the module will shut down and remain latch-off. The overcurrent latch is reset by either cycling the input power or by toggling the on/off pin for one second. If the output overload condition still exists when the module restarts, it will shut down again. This operation will continue indefinitely until the overcurrent condition is corrected.

An auto-restart option is also available.

Remote On/Off

Two remote on/off options are available. Positive logic remote on/off turns the module on during a logic-high voltage on the ON/OFF pin, and off during a logic low. Negative logic remote on/off turns the module off during a logic high and on during a logic low. Negative logic, device code suffix "1," is the factory-preferred configuration. To turn the power module on and off, the user must supply a switch to control the voltage between the on/off terminal and the VI (-) terminal (Von/off). The switch can be an open collector or equivalent (see Figure 34). A logic low is Von/off = 0 V to 1.2 V. The maximum Ion/off during a logic low is 1 mA. The switch should maintain a logic-low voltage while sinking 1 mA. During a logic high, the maximum Von/off generated by the power module is 15 V. The maximum allowable leakage current of the switch at Von/off = 15 V is 50 μ A. If not using the remote on/off feature, perform one of the following to turn the unit on:

For negative logic, short ON/OFF pin to VI(-).

For positive logic: leave ON/OFF pin open.

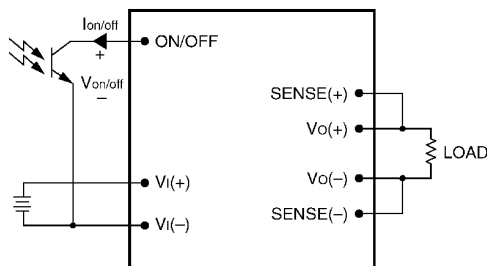

Figure 34. Remote On/Off Implementation.

Remote Sense

Remote sense minimizes the effects of distribution losses by regulating the voltage at the remote-sense connections. The voltage between the remote-sense pins and the output terminals must not exceed the

output voltage sense range given in the Feature Specifications table i.e.:

$$[V_o(+)-V_o(-)]-[SENSE(+)-SENSE(-)]\leq 10\% \text{ of } V_{o,nom}$$

The voltage between the Vo(+) and Vo(-) terminals must not exceed the minimum output overvoltage shut-down value indicated in the Feature Specifications table. This limit includes any increase in voltage due to remote-sense compensation and output voltage set-point adjustment (trim). See Figure 35. If not using the remote-sense feature to regulate the output at the point of load, then connect SENSE(+) to Vo(+) and SENSE(-) to Vo(-) at the module.

Although the output voltage can be increased by both the remote sense and by the trim, the maximum increase for the output voltage is not the sum of both. The maximum increase is the larger of either the remote sense or the trim. The amount of power delivered by the module is defined as the voltage at the output terminals multiplied by the output current. When using remote sense and trim: the output voltage of the module can be increased, which at the same output current would increase the power output of the module. Care should be taken to ensure that the maximum output power of the module remains at or below the maximum rated power.

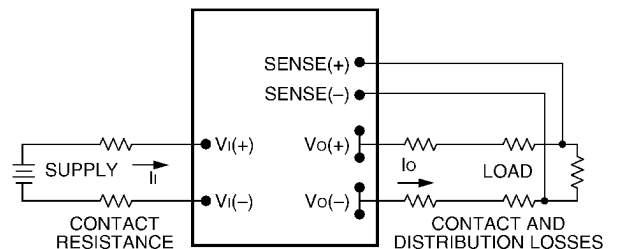

Figure 35. Effective Circuit Configuration for Single-Module Remote-Sense Operation Output Voltage.

Output Voltage Set-Point Adjustment (Trim)

Trimming allows the user to increase or decrease the output voltage set point of a module. This is accomplished by connecting an external resistor between the TRIM pin and either the SENSE(+) or SENSE(-) pins. The trim resistor should be positioned close to the module.

If not using the trim feature, leave the TRIM pin open.

With an external resistor between the TRIM and SENSE(-) pins (Radj-down), the output voltage set point (Vo,adj) decreases (see Figure 36). The following equation determines the required external-

Feature Description (continued)

Output Voltage Set-Point Adjustment (Trim)

resistor value to obtain a percentage output voltage change of $\Delta\%$.

For output voltages: 1.5V – 3.3V

$$R_{adj-down} = \left(\frac{510}{\Delta\%} - 10.2 \right) K\Omega$$

For output voltage: 1.2V

$$R_{adj-down} = \left(\frac{1299.1}{\Delta\%} - 33.49 \right) K\Omega$$

Where,

$$\Delta\% = \left| \frac{V_{o,nom} - V_{desired}}{V_{o,nom}} \right| \times 100$$

$V_{desired}$ = Desired output voltage set point (V).

With an external resistor connected between the TRIM and SENSE(+) pins (R_{adj-up}), the output voltage set point ($V_{o,adj}$) increases (see Figure 37).

The following equation determines the required external-resistor value to obtain a percentage output voltage change of $\Delta\%$.

For output voltages: 1.5V – 3.3V

$$R_{adj-up} = \left(\frac{5.1 * V_{o,nom} * (100 + \Delta\%)}{1.225 * \Delta\%} - \frac{510}{\Delta\%} - 10.2 \right) K\Omega$$

For output voltage: 1.2V

$$R_{adj-up} = \left(\frac{9.769 * V_{o,nom} * (100 + \Delta\%)}{0.6 * \Delta\%} - \frac{1299.1}{\Delta\%} - 33.49 \right) K\Omega$$

Where,

$$\Delta\% = \left| \frac{V_{desired} - V_{o,nom}}{V_{o,nom}} \right| \times 100$$

$V_{desired}$ = Desired output voltage set point (V).

The voltage between the $V_o(+)$ and $V_o(-)$ terminals must not exceed the minimum output overvoltage shut-down value indicated in the Feature Specifications table. This limit includes any increase in voltage due to remote-sense compensation and output voltage set-point adjustment (trim). See Figure 35.

Although the output voltage can be increased by both the remote sense and by the trim, the maximum increase for the output voltage is not the sum of both. The maximum increase is the larger of either the remote sense or the trim.

The amount of power delivered by the module is defined as the voltage at the output terminals multiplied by the output current. When using remote sense and trim, the output voltage of the module can be increased, which at the same output current would increase the power output of the module. Care should be taken to ensure that the maximum output power of the module remains at or below the maximum rated power.

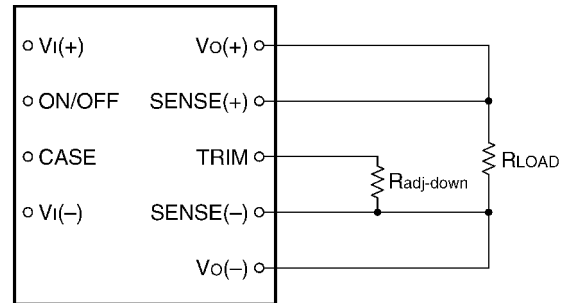

8-748 (F). b

Figure 36. Circuit Configuration to Decrease Output Voltage .

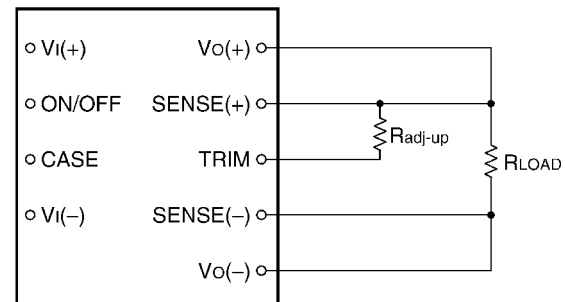

8-715 (F).b

Figure 37. Circuit Configuration to Increase Output Voltage.

Examples:

To trim down the output of a nominal 3.3V module (QPW050A0F) to 3.1V

$$\Delta\% = \left| \frac{3.3V - 3.1V}{3.3V} \right| \times 100$$

$$\Delta\% = 6.06$$

$$R_{adj-down} = \left(\frac{510}{6.06} - 10.2 \right) K\Omega$$

$$R_{adj-down} = 73.96 \text{ k}\Omega$$

To trim up the output of a nominal 3.3V module (QPW050A0F) to 3.6V

$$\Delta\% = \left| \frac{3.6V - 3.3V}{3.3V} \right| \times 100$$

Feature Description (continued)

Output Voltage Set-Point Adjustment (Trim)

$$\Delta\% = 9.1$$

$$\Delta\% = \left| \frac{28V - 29.6V}{28V} \right| \times 100$$

$$\Delta\% = 5$$

$$R_{adj-up} = \left[10 \times \left(\left(\frac{1036}{5} \right) + 936 \right) \right] K\Omega$$

$$R_{tadj-up} = 11432 \text{ k}\Omega$$

$$R_{adj-up} = \left(\frac{5.1 * 3.3 * (100 + 9.1)}{1.225 * 9.1} - \frac{510}{9.1} - 10.2 \right) K\Omega$$

$$R_{tadj-up} = 98.47 \text{ k}\Omega$$

Output Over Voltage Protection

The output overvoltage protection consists of circuitry that monitors the voltage on the output terminals. If the voltage on the output terminals exceeds the over voltage protection threshold, then the module will shutdown and latch off. The overvoltage latch is reset by either cycling the input power for one second or by toggling the on/off signal for one second. The protection mechanism is such that the unit can continue in this condition until the fault is cleared.

Over Temperature Protection

These modules feature an overtemperature protection circuit to safeguard against thermal damage. The circuit shuts down and latches off the module when the maximum device reference temperature is exceeded. The module can be restarted by cycling the dc input power for at least one second or by toggling the remote on/off signal for at least one second.

Input Under/Over Voltage Lockout

At input voltages below the input undervoltage lockout limit, the module operation is disabled. The module will begin to operate at an input voltage above the undervoltage lockout turn-on threshold.

Thermal Considerations

The power modules operate in a variety of thermal environments; however, sufficient cooling should be provided to help ensure reliable operation.

Considerations include ambient temperature, airflow, module power dissipation, and the need for increased reliability. A reduction in the operating temperature of the module will result in an increase in reliability. The thermal data presented here is based on physical measurements taken in a wind tunnel.

Heat-dissipating components are mounted on the top side of the module. Heat is removed by conduction, convection and radiation to the surrounding environment. Proper cooling can be verified by measuring the thermal reference temperature (T_{ref}). Peak temperature (T_{ref}) occurs at the position indicated in Figures 38 - 40. For reliable operation this temperature should not exceed listed temperature threshold.

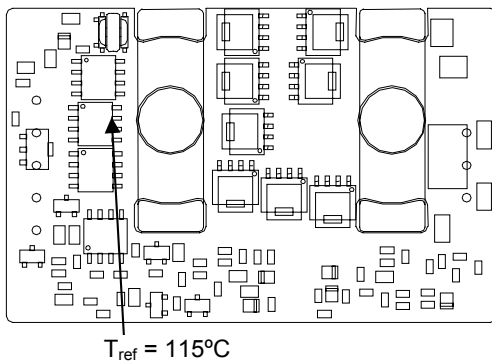

Figure 38. T_{ref} Temperature Measurement Location for $V_o=3.3V - 2.5V$.

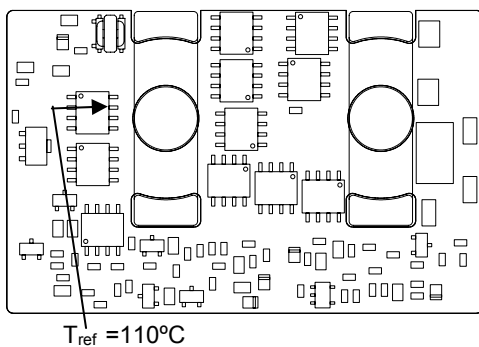

Figure 39. T_{ref} Temperature Measurement Location for $V_o=1.8V$.

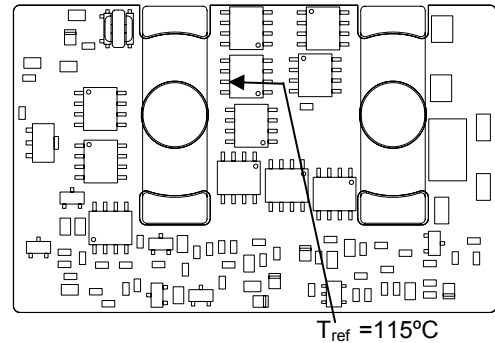

Figure 40. T_{ref} Temperature Measurement Location for $V_o= 1.5V - 1.2V$

The output power of the module should not exceed the rated power for the module as listed in the Ordering Information table.

Although the maximum T_{ref} temperature of the power modules is $110^\circ C - 115^\circ C$, you can limit this temperature to a lower value for extremely high reliability.

Heat Transfer via Convection

Increased airflow over the module enhances the heat transfer via convection. Following derating figures shows the maximum output current that can be delivered by each module in the respective orientation without exceeding the maximum T_{ref} temperature versus local ambient temperature (T_A) for natural convection through 2m/s (400 ft./min).

Note that the natural convection condition was measured at 0.05 m/s to 0.1 m/s (10ft./min. to 20 ft./min.); however, systems in which these power modules may be used typically generate natural convection airflow rates of 0.3 m/s (60 ft./min.) due to other heat dissipating components in the system. The use of Figures 41 - 50 are shown in the following example:

Example

What is the minimum airflow necessary for a QPW050A0F operating at $V_I = 48V$, an output current of 30A, and a maximum ambient temperature of $70^\circ C$ in longitudinal orientation.

Solution:

Given: $V_I = 48V$

$I_o = 30A$

$T_A = 70^\circ C$

Determine airflow (V) (Use Figure 41):

$V = 1m/sec. (200ft./min.)$

The following figures provide thermal derating characteristics.

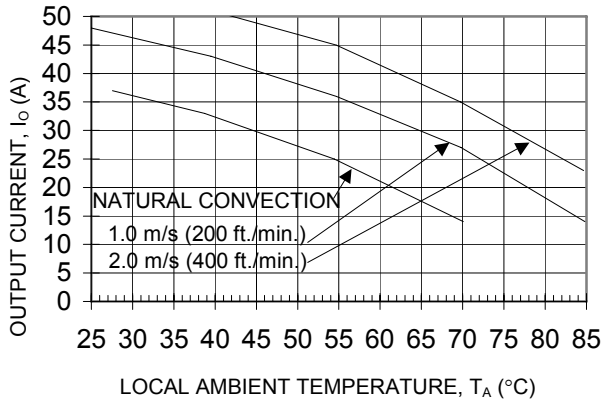

Figure 41. Output Power Derating for QPW050A0F ($V_o = 3.3V$) in Longitudinal Orientation with no baseplate; Airflow Direction From $V_{in}(-)$ to $V_{out}(-)$; $V_{in} = 48V$.

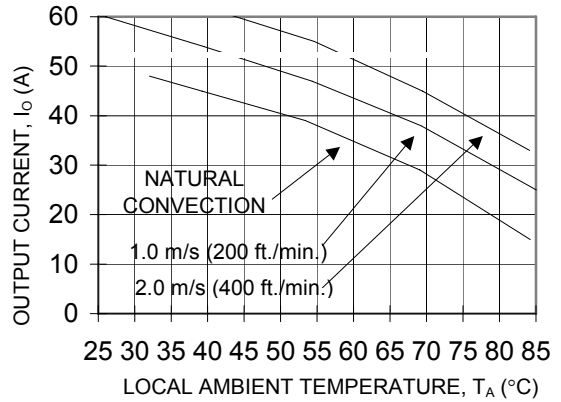

Figure 44. Output Power Derating for QPW060A0G ($V_o = 2.5V$) in Transverse Orientation with no baseplate; Airflow Direction From $V_{in}(-)$ to $V_{in}(+)$; $V_{in} = 48V$.

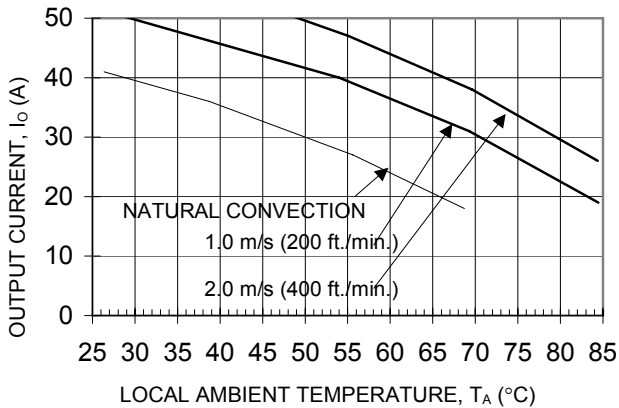

Figure 42. Output Power Derating for QPW050A0F ($V_o = 3.3V$) in Transverse Orientation with no baseplate; Airflow Direction From $V_{in}(-)$ to $V_{in}(+)$; $V_{in} = 48V$.

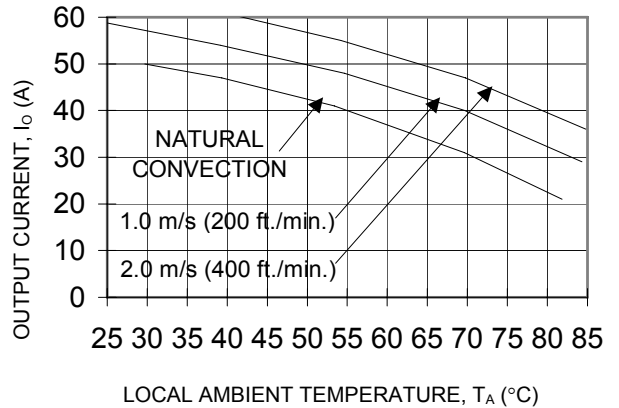

Figure 45. Output Power Derating for QPW060A0Y ($V_o = 1.8V$) in Longitudinal Orientation with no baseplate; Airflow Direction From $V_{in}(-)$ to $V_{out}(-)$; $V_{in} = 48V$.

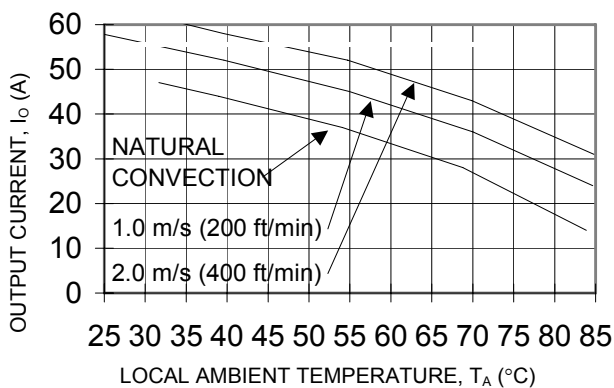

Figure 43. Output Power Derating for QPW060A0G ($V_o = 2.5V$) in Longitudinal Orientation with no baseplate; Airflow Direction From $V_{in}(-)$ to $V_{out}(-)$; $V_{in} = 48V$.

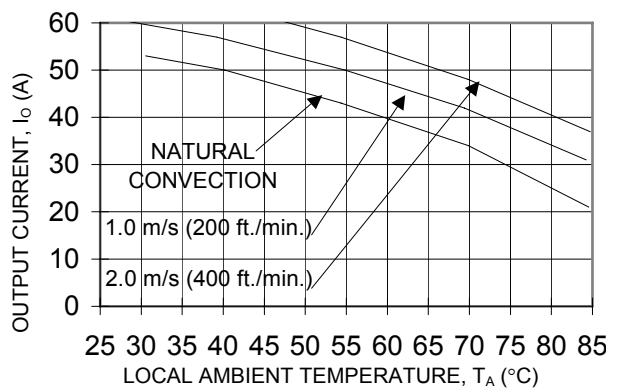

Figure 46. Output Power Derating for QPW060A0Y ($V_o = 1.8V$) in Transverse Orientation with no baseplate; Airflow Direction From $V_{in}(-)$ to $V_{in}(+)$; $V_{in} = 48V$.

The following figures provide thermal derating characteristics.

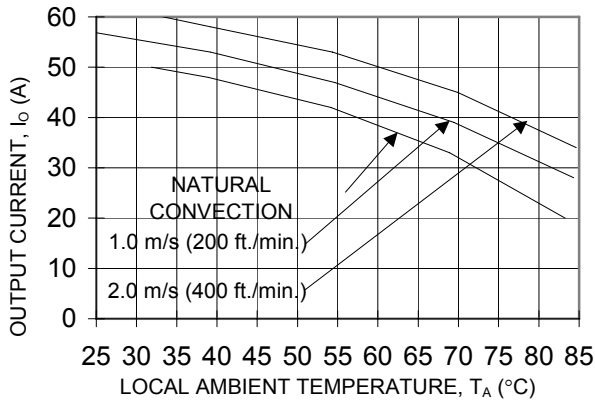

Figure 47. Output Power Derating for QPW060A0M ($V_o = 1.5V$) in Longitudinal Orientation with no baseplate; Airflow Direction From $V_{in}(-)$ to $V_{out}(-)$; $V_{in} = 48V$.

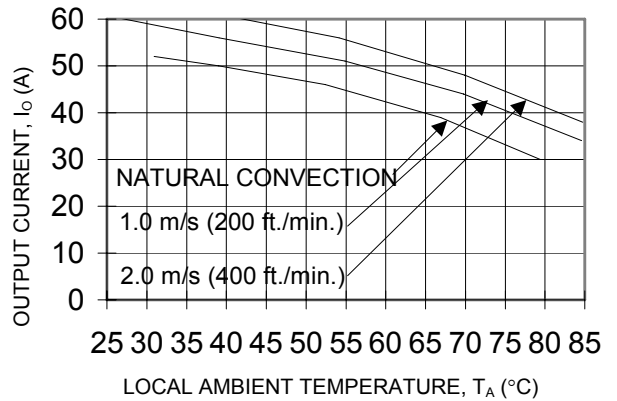

Figure 50. Output Power Derating for QPW060A0P ($V_o = 1.2V$) in Transverse Orientation with no baseplate; Airflow Direction From $V_{in}(-)$ to $V_{in}(+)$; $V_{in} = 48V$.

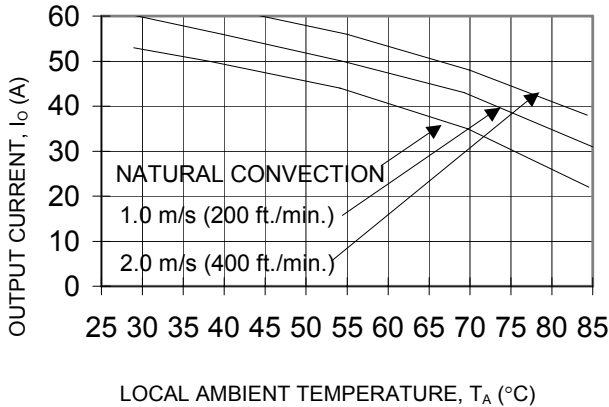

Figure 48. Output Power Derating for QPW060A0M ($V_o = 1.5V$) in Transverse Orientation with no baseplate; Airflow Direction From $V_{in}(-)$ to $V_{in}(+)$; $V_{in} = 48V$.

Please refer to the Application Note "Thermal Characterization Process For Open-Frame Board-Mounted Power Modules" for a detailed discussion of thermal aspects including maximum device temperatures.

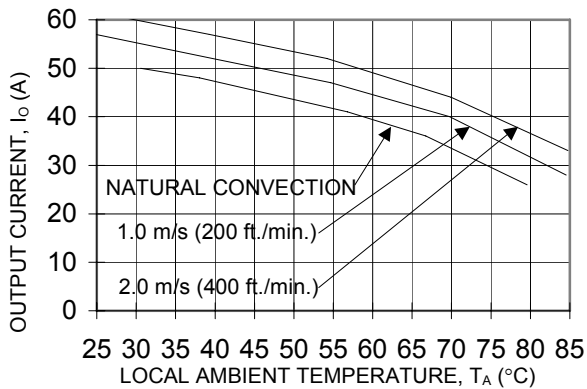

Figure 49. Output Power Derating for QPW060A0P ($V_o = 1.2V$) in Longitudinal Orientation with no baseplate; Airflow Direction From $V_{in}(-)$ to $V_{out}(-)$; $V_{in} = 48V$.

Layout Considerations

The QPW power module series are low profile in order to be used in fine pitch system card architectures. As such, component clearance between the bottom of the power module and the mounting board is limited. Avoid placing copper areas on the outer layer directly underneath the power module. Also avoid placing via interconnects underneath the power module.

For additional layout guide-lines, refer to FLTR100V10 data sheet.

Post solder Cleaning and Drying Considerations

Post solder cleaning is usually the final circuit-board assembly process prior to electrical board testing. The result of inadequate cleaning and drying can affect both the reliability of a power module and the testability of the finished circuit-board assembly. For guidance on appropriate soldering, cleaning and drying procedures, refer to *Lineage Power Board Mounted Power Modules: Soldering and Cleaning* Application Note.

Through-Hole Lead-Free Soldering Information

The RoHS-compliant through-hole products use the SAC (Sn/Ag/Cu) Pb-free solder and RoHS-compliant components. They are designed to be processed through single or dual wave soldering machines. The pins have an RoHS-compliant finish that is compatible with both Pb and Pb-free wave soldering processes. A maximum preheat rate of 3°C/s is suggested. The wave preheat process should be such that the temperature of the power module board is kept below 210°C. For Pb solder, the recommended pot temperature is 260°C, while the Pb-free solder pot is 270°C max. Not all RoHS-compliant through-hole products can be processed with paste-through-hole Pb or Pb-free reflow process. If additional information is needed, please consult with your Lineage Power representative for more details.

Mechanical Outline for Through-Hole Module

Dimensions are in millimeters and [inches].

Tolerances: $x.x \text{ mm} \pm 0.5 \text{ mm}$ [$x.xx \text{ in.} \pm 0.02 \text{ in.}$] (Unless otherwise indicated)

$x.xx \text{ mm} \pm 0.25 \text{ mm}$ [$x.xxx \text{ in.} \pm 0.010 \text{ in.}$]

TOP VIEW

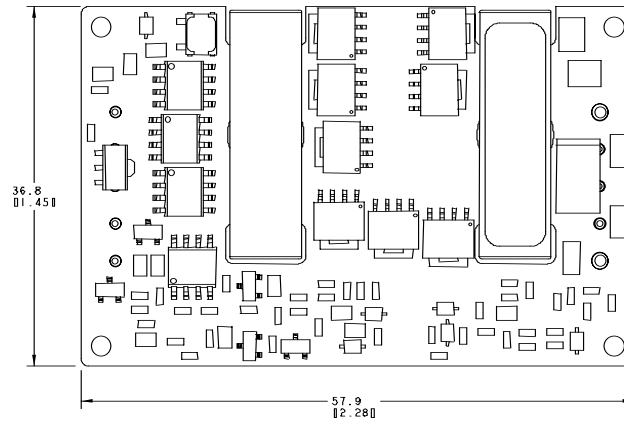

SIDE VIEW

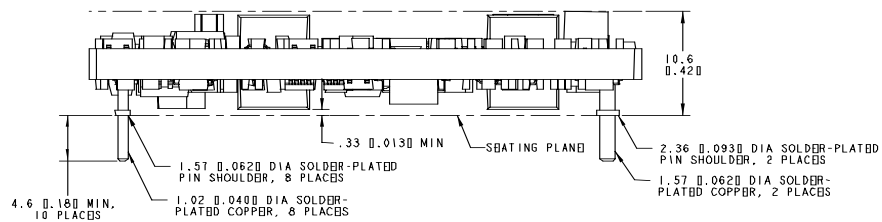

BOTTOM VIEW

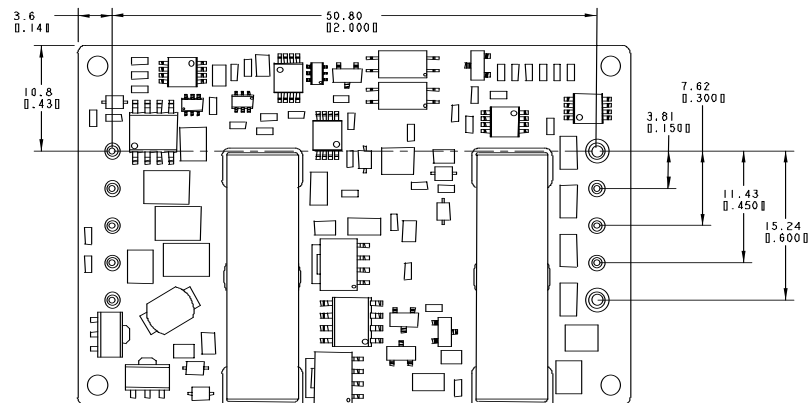

*Side label includes Lineage Power name, product designation, and data code.
 Option Feature, Pin is not present unless one these options specified

Recommended Pad Layout for Through Hole Module

Dimensions are in millimeters and (inches).

Tolerances: $x.x \text{ mm} \pm 0.5 \text{ mm}$ ($x.xx \text{ in.} \pm 0.02 \text{ in.}$) [unless otherwise indicated]

$x.xx \text{ mm} \pm 0.25 \text{ mm}$ ($x.xxx \text{ in} \pm 0.010 \text{ in.}$)

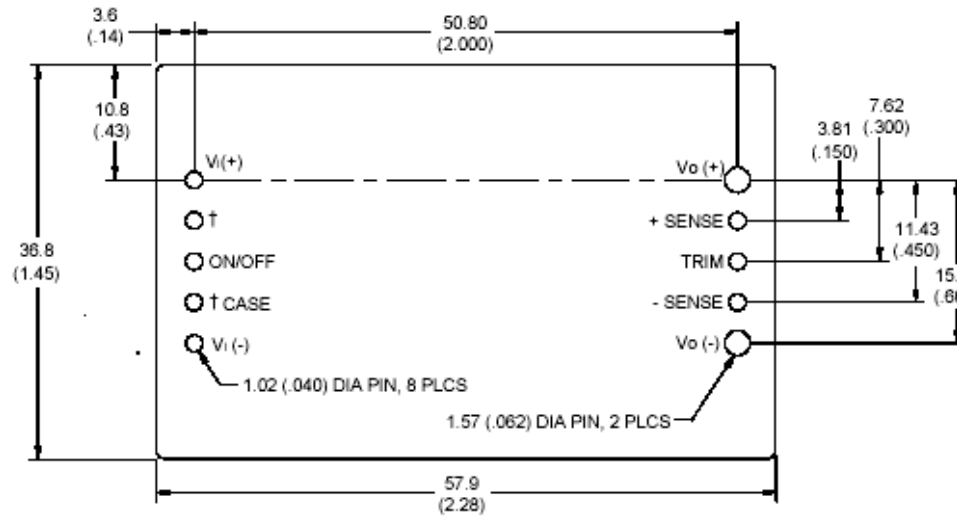

Ordering Information

Please contact your Lineage Power Sales Representative for pricing, availability and optional features.

Table 1. Device Code

Product codes	Input Voltage	Output Voltage	Output Current	Efficiency	Connector Type	Comcodes
QPW050A0F1	48V (36-75Vdc)	3.3V	50A	93%	Through hole	108968686
QPW060A0G1	48V (36-75Vdc)	2.5V	60A	91%	Through hole	108982232
QPW060A0Y1	48V (36-75Vdc)	1.8V	60A	89%	Through hole	108982265
QPW060A0M1	48V (36-75Vdc)	1.5V	60A	87%	Through hole	108982240
QPW060A0P1	48V (36-75Vdc)	1.2V	60A	85%	Through hole	108982257
QPW050A0F1-HZ	48V (36-75Vdc)	3.3V	50A	93%	Through hole	CC109107182
QPW060A0G1Z	48V (36-75Vdc)	2.5V	60A	91%	Through hole	CC109107216
QPW060A0M641Z	48V (36-75Vdc)	1.5V	60A	87%	Through hole	CC109105021
QPW060A0P641Z	48V (36-75Vdc)	1.2V	60A	85%	Through hole	CC109101466

Table 2. Device Options

Option	Suffix
Negative remote on/off logic	1
Auto-restart	4
Pin Length: 3.68 mm \pm 0.25mm (0.145 in. \pm 0.010 in.)	6
Base Plate option	-H
RoHS Compliant	-Z

Note: Legacy device codes may contain a –B option suffix to indicate 100% factory Hi-Pot tested to the isolation voltage specified in the Absolute Maximum Ratings table. The 100% Hi-Pot test is now applied to all device codes, with or without the –B option suffix. Existing comcodes for devices with the –B suffix are still valid; however, no new comcodes for devices containing the –B suffix will be created.



World Wide Headquarters
Lineage Power Corporation
3000 Skyline Drive, Mesquite, TX 75149, USA
+1-800-526-7819
(Outside U.S.A.: **+1-972-284-2626**)
www.lineagepower.com
e-mail: techsupport1@lineagepower.com

Asia-Pacific Headquarters
Tel: +65 6416 4283

Europe, Middle-East and Africa Headquarters
Tel: +49 89 6089 286

India Headquarters
Tel: +91 80 28411633

Lineage Power reserves the right to make changes to the product(s) or information contained herein without notice. No liability is assumed as a result of their use or application. No rights under any patent accompany the sale of any such product(s) or information.

© 2008 Lineage Power Corporation, (Mesquite, Texas) All International Rights Reserved.