

(2SA1302)

POWER AMPLIFIER APPLICATIONS.

- Complementary to 2SC3281
- Recommend for 100W High Fidelity Audio Frequency Amplifier Output Stage.

MAXIMUM RATINGS (Ta = 25°C)

CHARACTERISTIC	SYMBOL	RATING	UNIT
Collector-Base Voltage	V _{CB0}	-200	V
Collector-Emitter Voltage	V _{CEO}	-200	V
Emitter-Base Voltage	V _{EBO}	-5	V
Collector Current	I _C	-15	A
Base Current	I _B	-1.5	A
Collector Power Dissipation (T _c = 25°C)	P _C	150	W
Junction Temperature	T _j	150	°C
Storage Temperature Range	T _{stg}	-55~150	°C

Unit in mm

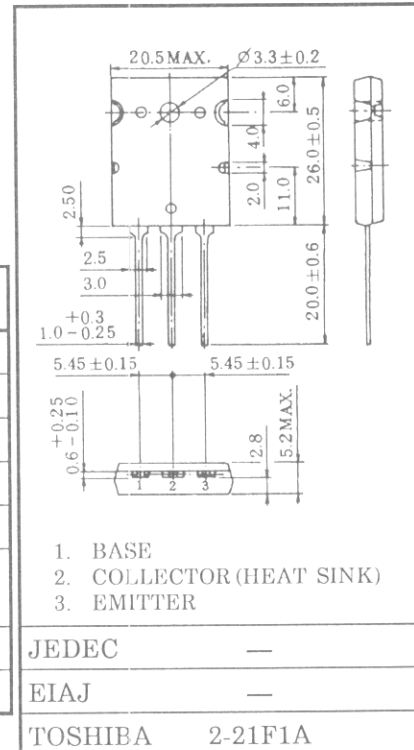

Weight : 9.75g

ELECTRICAL CHARACTERISTICS (Ta = 25°C)

CHARACTERISTIC	SYMBOL	TEST CONDITION	MIN.	TYP.	MAX.	UNIT
Collector Cut-off Current	I _{CB0}	V _{CB} = -200V, I _E = 0	--	--	-5.0	μA
Emitter Cut-off Current	I _{EBO}	V _{EB} = -5V, I _C = 0	--	--	-5.0	μA
Collector-Emitter Breakdown Voltage	V _{(BR)CEO}	I _C = -50mA, I _B = 0	-200	--	--	V
DC Current Gain	h _{FE(1)} (Note)	V _{CE} = -5V, I _C = -1A	55	--	160	
	h _{FE(2)}	V _{CE} = -5V, I _C = -8A	35	60	--	
Collector-Emitter Saturation Voltage	V _{CE(sat)}	I _C = -10A, I _B = -1A	--	-1.5	-3.0	V
Base-Emitter Voltage	V _{BE}	V _{CE} = -5V, I _C = -8A	--	-1.0	-1.5	V
Transition Frequency	f _T	V _{CE} = -5V, I _C = -1A	--	25	--	MHz
Collector Output Capacitance	C _{ob}	V _{CB} = -10V, I _E = 0, f = 1MHz	--	470	--	pF

Note : h_{FE(1)} Classification R : 55~110, O : 80~160

© The information contained herein is presented only as a guide for the applications of our products. No responsibility is assumed by TOSHIBA CORPORATION for any infringements of intellectual property or other rights of the third parties which may result from its use. No license is granted by implication or otherwise under any intellectual property or other rights of TOSHIBA CORPORATION or others.

② These TOSHIBA products are intended for use in general commercial applications (office equipment, communication equipment, measuring equipment, domestic appliances, etc.). please make sure that you consult with us before you use these TOSHIBA products in equipment which requires extraordinarily high quality and/or reliability, and in equipment which may involve life threatening or critical application, including but not limited to such uses as atomic energy control, airplane or spaceship instrumentation, traffic signals, medical instrumentation, combustion control, all types of safety devices, etc. TOSHIBA cannot accept and hereby disclaims liability for any damage which may occur in case the TOSHIBA products are used in such equipment or applications without prior consultation with TOSHIBA.

(2SA1302)

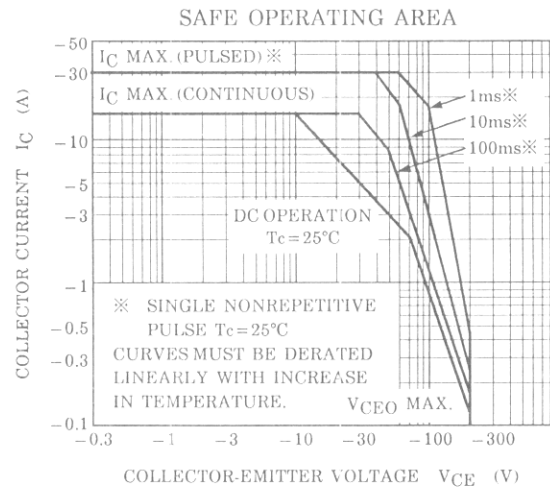
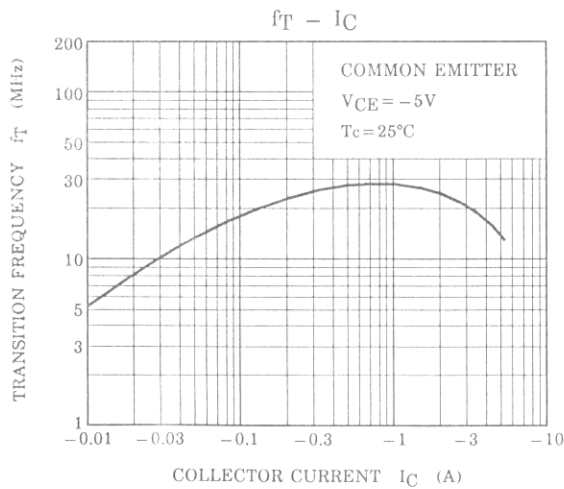
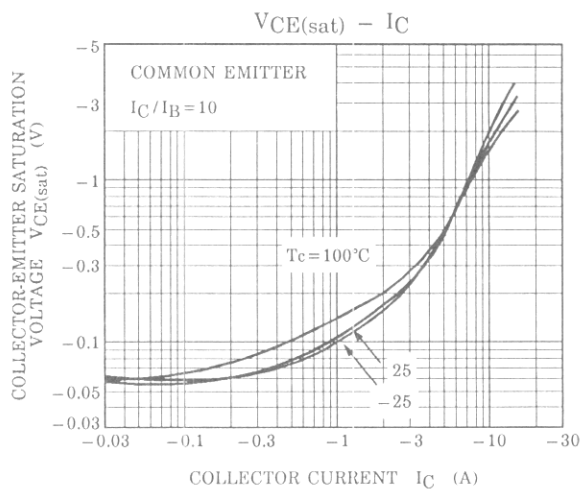
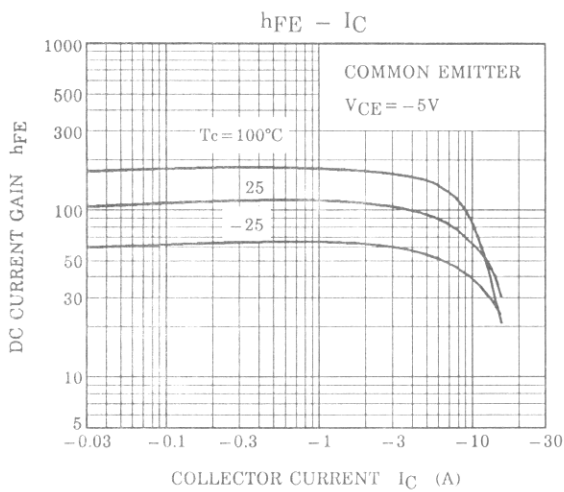
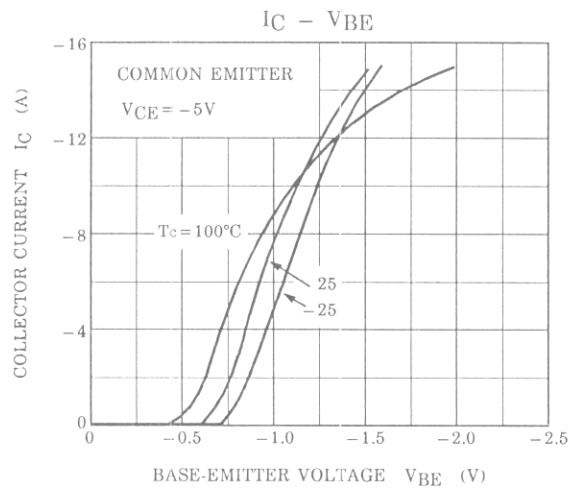
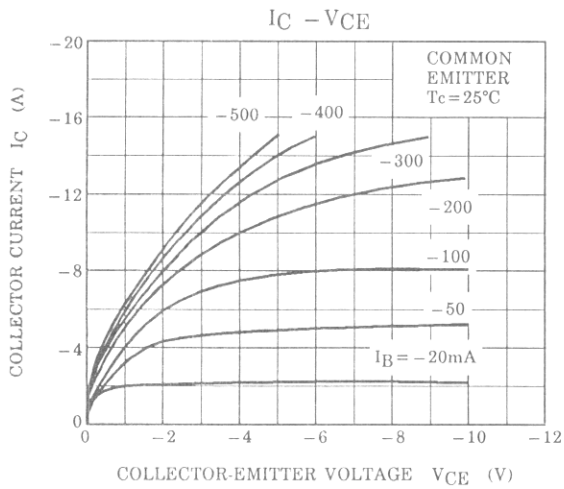

2SA1302 - 2*
 1994 - 5 - 14
TOSHIBA CORPORATION

(2SA1302)

POWER AMPLIFIER APPLICATIONS.

- Complementary to 2SC3281
- Recommend for 100W High Fidelity Audio Frequency Amplifier Output Stage.

MAXIMUM RATINGS (Ta = 25°C)

CHARACTERISTIC	SYMBOL	RATING	UNIT
Collector-Base Voltage	V _{CB0}	-200	V
Collector-Emitter Voltage	V _{CEO}	-200	V
Emitter-Base Voltage	V _{EB0}	-5	V
Collector Current	I _C	-15	A
Base Current	I _B	-1.5	A
Collector Power Dissipation (T _c = 25°C)	P _C	150	W
Junction Temperature	T _j	150	°C
Storage Temperature Range	T _{stg}	-55~150	°C

Unit in mm

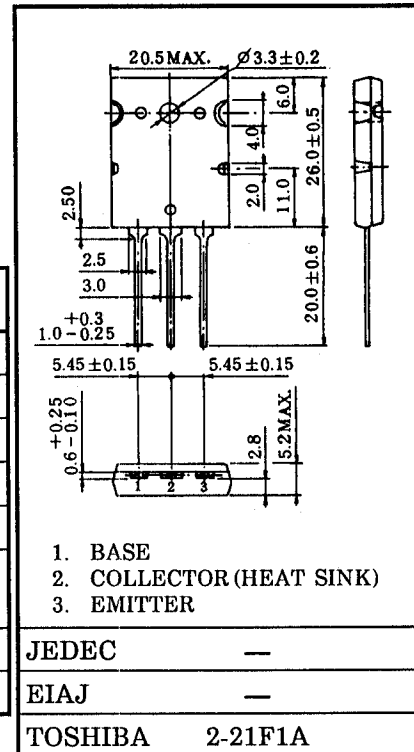

ELECTRICAL CHARACTERISTICS (Ta = 25°C)

Weight : 9.75g

CHARACTERISTIC	SYMBOL	TEST CONDITION	MIN.	TYP.	MAX.	UNIT
Collector Cut-off Current	I _{CBO}	V _{CB} = -200V, I _E = 0	—	—	-5.0	μA
Emitter Cut-off Current	I _{EB0}	V _{EB} = -5V, I _C = 0	—	—	-5.0	μA
Collector-Emitter Breakdown Voltage	V _{(BR)CEO}	I _C = -50mA, I _B = 0	-200	—	—	V
DC Current Gain	h _{FE} (1) (Note)	V _{CE} = -5V, I _C = -1A	55	—	160	
	h _{FE} (2)	V _{CE} = -5V, I _C = -8A	35	60	—	
Collector-Emitter Saturation Voltage	V _{CE(sat)}	I _C = -10A, I _B = -1A	—	-1.5	-3.0	V
Base-Emitter Voltage	V _{BE}	V _{CE} = -5V, I _C = -8A	—	-1.0	-1.5	V
Transition Frequency	f _T	V _{CE} = -5V, I _C = -1A	—	25	—	MHz
Collector Output Capacitance	C _{ob}	V _{CB} = -10V, I _E = 0, f = 1MHz	—	470	—	pF

Note : h_{FE}(1) Classification R : 55~110, O : 80~160

① The information contained herein is presented only as a guide for the applications of our products. No responsibility is assumed by TOSHIBA CORPORATION for any infringements of intellectual property or other rights of the third parties which may result from its use. No license is granted by implication or otherwise under any intellectual property or other rights of TOSHIBA CORPORATION or others.
② These TOSHIBA products are intended for use in general commercial applications (office equipment, communication equipment, measuring equipment, domestic appliances, etc.) please make sure that you consult with us before you use these TOSHIBA products in equipment which requires extraordinarily high quality and/or reliability, and in equipment which may involve life threatening or critical application, including but not limited to such uses as atomic energy control, airplane or spaceship instrumentation, traffic signals, medical instrumentation, combustion control, all types of safety devices, etc. TOSHIBA cannot accept and hereby disclaims liability for any damage which may occur in case the TOSHIBA products are used in such equipment or applications without prior consultation with TOSHIBA.

2SA1302 - 1
1994 - 5 - 14
TOSHIBA CORPORATION

(2SA1302)

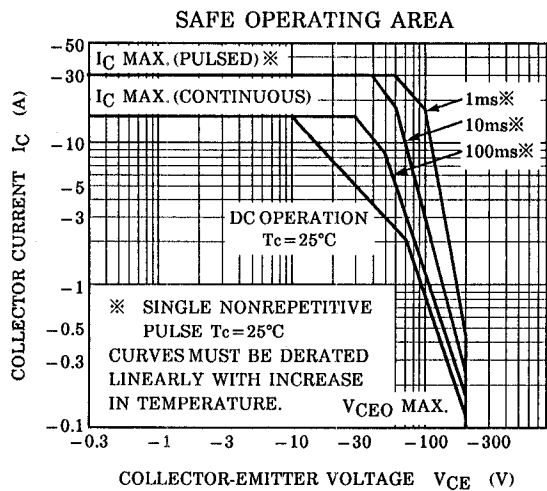
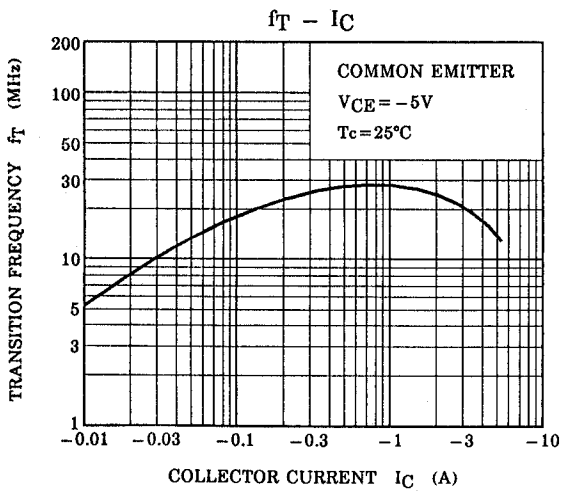
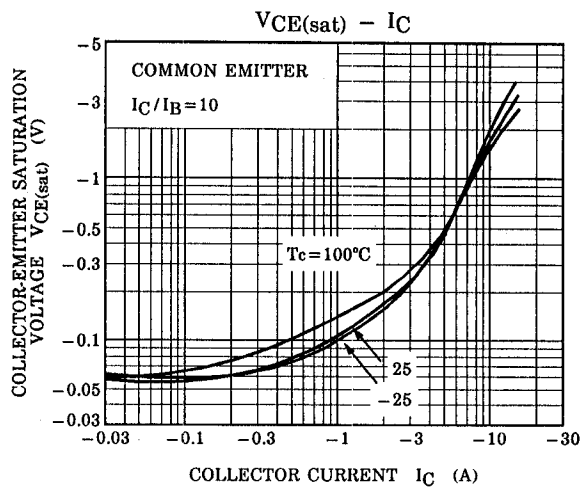
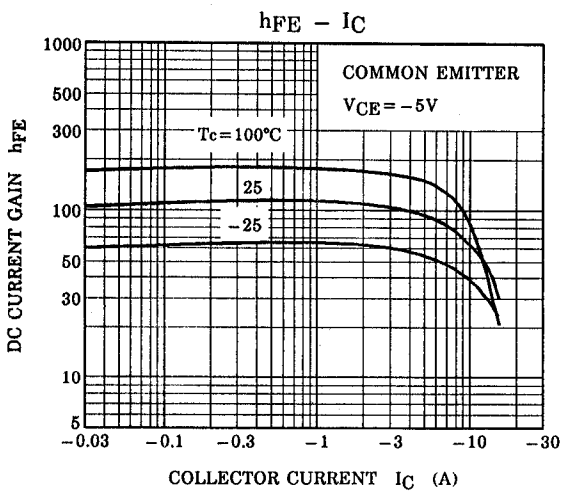
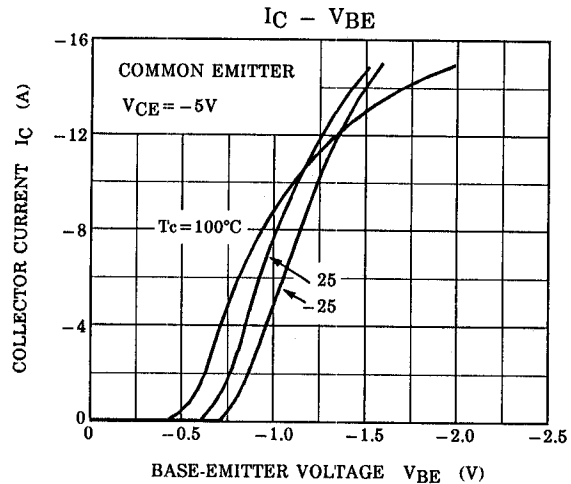
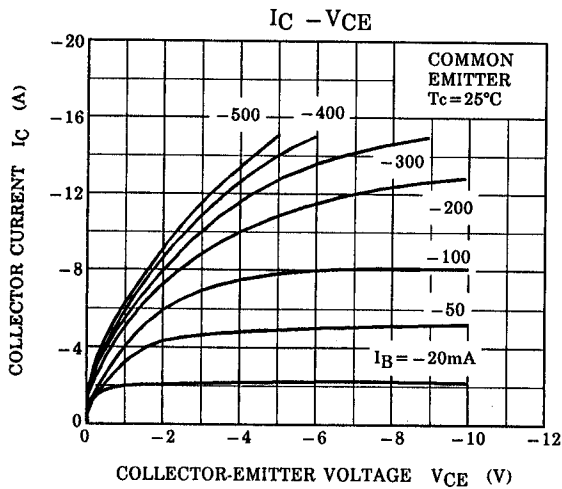

2SA1302-2*

1994-5-14

TOSHIBA CORPORATION