

VOLTAGE REGULATOR WITH RESET OUTPUT

FEATURES

- Very Low Dropout Voltage
- Reset Output for Microprocessor
- Very Low Quiescent Current (No Load)
- Internal Thermal/Overload Shutdown
- Low Noise Voltage
- Input and Output Voltage Sense
- $\pm 2.5\%$ Output Voltage Accuracy
- CMOS or TTL On/Off Control
- High Speed On/Off Transient (50 μ s typ.)

DESCRIPTION

The TK119xx series are low power, linear regulators with built-in electronic switches. Built-in voltage comparators provide a reset logic "low" level whenever the input or output voltage falls outside internally preset limits. The internal electronic switch can be controlled by CMOS or TLL levels. The device is in the "off" state when the control pin is biased "high".

An internal PNP pass-transistor is used in order to achieve low dropout voltage (typically 200 mV at 50 mA load current). The device has very low quiescent current (130 μ A) in the "on" mode with no load and 2 mA with 30 mA load. The quiescent current is typically 4 mA at 60 mA load. The current consumption in the "off" mode is 65 μ A. An internal thermal shutdown circuit limits the junction temperature to below 150 °C. The load current is internally monitored and the device will shut down (no load current) in the presence of a short circuit at the output. The output noise is very low at 100 dB down from V_{OUT} when an external noise bypass capacitor is used. The TK119xx is available in a miniature SOT-23L surface mount package.

FEATURES

- Battery Powered Systems
- Cellular Telephones
- Pagers
- Personal Communications Equipment
- Portable Instrumentation
- Portable Consumer Equipment
- Radio Control Systems
- Toys
- Low Voltage Systems

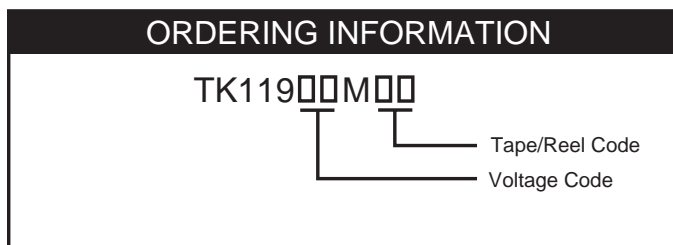
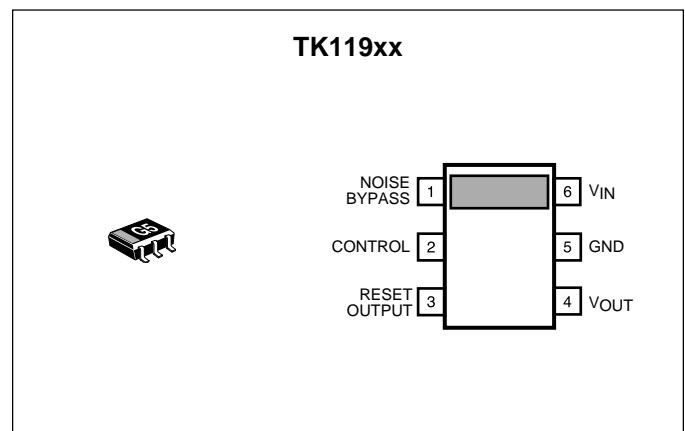

VOLTAGE CODE	
22 = 2.25 V	35 = 2.5 V
27 = 2.75 V	40 = 4.0 V
30 = 3.00 V	48 = 4.8 V
32 = 3.25 V	50 = 5.0 V

TAPE/REEL CODE
TL: Tape Left

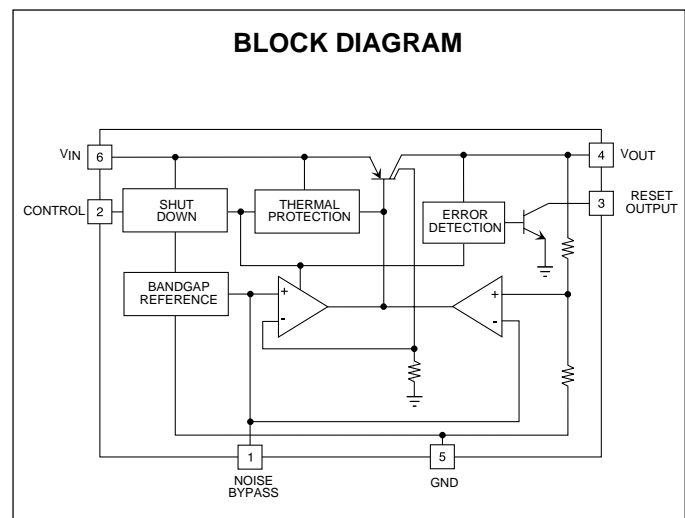

TK119xx

ABSOLUTE MAXIMUM RATINGS

Supply Voltage	17 V	Operating Temperature Range	-30 to +80 °C
Operating Voltage Range	1.8 to 16 V	Junction Temperature	150 °C
Power Dissipation (Note 1)	400 mW	Lead Soldering Temperature (10 s)	235 °C
Storage Temperature Range	-55 to +150 °C		

TK11922 ELECTRICAL CHARACTERISTICS

Test conditions: $V_{IN} = 3.25\text{ V}$, $C_L = 10\ \mu\text{F}$, $C_N = 0.01\ \mu\text{F}$, $T_A = 25\ ^\circ\text{C}$, unless otherwise specified.

SYMBOL	PARAMETER	TEST CONDITIONS	MIN	TYP	MAX	UNITS
I_Q	Quiescent Current	$I_{OUT} = 0\ \text{mA}$		140	300	μA
		$V_{IN} = 1.25\ \text{V}$, $I_{OUT} = 0\ \text{mA}$		380	900	μA
I_{GND}	Ground Current	$I_{OUT} = 60\ \text{mA}$		2.5	10	mA
I_{STBY}	Standby Current	Output OFF		95	160	μA
V_{OUT}	Output Voltage	$I_{OUT} = 1\ \text{mA}$, $T_A = 25\ ^\circ\text{C}$	2.17	2.25	2.33	V
		$I_{OUT} = 1\ \text{mA}$, $-30 \leq T_A \leq 80\ ^\circ\text{C}$	2.13	2.25	2.37	V
V_{DROP}	Dropout Voltage	$I_{OUT} = 30\ \text{mA}$		160	350	mV
I_{OUT}	Output Current				100	mA
Line Reg	Line Regulation	$V_{IN} = 3.25\ \text{to}\ 12.25\ \text{V}$		5	50	mV
Load Reg	Load Regulation	$I_{OUT} = 1\ \text{to}\ 80\ \text{mA}$		20	100	mV
$\Delta V_{OUT}/\Delta T$	Temperature Coefficient			± 0.2		$\text{mV}/^\circ\text{C}$
RR	Ripple Rejection	$f = 400\ \text{Hz}$, $C_L = 10\ \mu\text{F}$		68		dB
V_{NO}	Output Noise Voltage	$10\ \text{Hz} \leq f \leq 100\ \text{kHz}$, $C_L = 10\ \mu\text{F}$, $C_N = 0.01\ \mu\text{F}$		50		μVrms
V_{DET}	Low Voltage Detector Threshold		$V_{OUT} \times 0.95$			V
$V_{DET(ERR)}$	Voltage Detector Threshold Tolerance		-4	V_{DET}	+4	%
V_{RESET}	Saturation Voltage	$I_{FLAG} = 100\ \mu\text{A}$		0.2	0.4	V
CONTROL TERMINAL SPECIFICATIONS						
I_{CONT}	Control Terminal Current	$V_{CONT} = 5\ \text{V}$		25	100	μA
		$V_{CONT} = 16\ \text{V}$		45	150	μA
$V_{CONT(ON)}$	Control Voltage (ON)	Output ON			0.6	V
$V_{CONT(OFF)}$	Control Voltage (OFF)	Output OFF	2.2			V
T_R	Output Rise Time (OFF to ON)	$I_{OUT} = 30\ \text{mA}$, $C_L = 0.1\ \mu\text{F}$, $C_N = 0.1\ \mu\text{F}$		50		μs

Note 1: Power dissipation is 400 mW when mounted as recommended. Derate at 3.2 mW/°C for operation above 25°C.

TK11927 ELECTRICAL CHARACTERISTICS

Test conditions: $V_{IN} = 3.75\text{ V}$, $C_L = 10\ \mu\text{F}$, $C_N = 0.01\ \mu\text{F}$, $T_A = 25\ ^\circ\text{C}$, unless otherwise specified.

SYMBOL	PARAMETER	TEST CONDITIONS	MIN	TYP	MAX	UNITS
I_Q	Quiescent Current	$I_{OUT} = 0\ \text{mA}$		140	300	μA
		$V_{IN} = 1.75\ \text{V}$, $I_{OUT} = 0\ \text{mA}$		380	900	μA
I_{GND}	Ground Current	$I_{OUT} = 60\ \text{mA}$		2.5	10	mA
I_{STBY}	Standby Current	Output OFF		95	160	μA
V_{OUT}	Output Voltage	$I_{OUT} = 1\ \text{mA}$, $T_A = 25\ ^\circ\text{C}$	2.67	2.75	2.83	V
		$I_{OUT} = 1\ \text{mA}$, $-30 \leq T_A \leq 80\ ^\circ\text{C}$	2.63	2.75	2.87	V
V_{DROP}	Dropout Voltage	$I_{OUT} = 30\ \text{mA}$		160	350	mV
I_{OUT}	Output Current				100	mA
Line Reg	Line Regulation	$V_{IN} = 3.75\ \text{to}\ 12.75\ \text{V}$		5	50	mV
Load Reg	Load Regulation	$I_{OUT} = 1\ \text{to}\ 80\ \text{mA}$		20	100	mV
$\Delta V_{OUT}/\Delta T$	Temperature Coefficient			± 0.2		$\text{mV}/^\circ\text{C}$
RR	Ripple Rejection	$f = 400\ \text{Hz}$, $C_L = 10\ \mu\text{F}$		68		dB
V_{NO}	Output Noise Voltage	$10\ \text{Hz} \leq f \leq 100\ \text{kHz}$, $C_L = 10\ \mu\text{F}$, $C_N = 0.01\ \mu\text{F}$		50		μVrms
V_{DET}	Low Voltage Detector Threshold		$V_{OUT} \times 0.95$			V
$V_{DET(ERR)}$	Voltage Detector Threshold Tolerance		-4	V_{DET}	+4	%
V_{RESET}	Saturation Voltage	$I_{FLAG} = 100\ \mu\text{A}$		0.2	0.4	V
CONTROL TERMINAL SPECIFICATIONS						
I_{CONT}	Control Terminal Current	$V_{CONT} = 5\ \text{V}$		25	100	μA
		$V_{CONT} = 16\ \text{V}$		45	150	μA
$V_{CONT(ON)}$	Control Voltage (ON)	Output ON			0.6	V
$V_{CONT(OFF)}$	Control Voltage (OFF)	Output OFF	2.4			V
T_R	Output Rise Time (OFF to ON)	$I_{OUT} = 30\ \text{mA}$, $C_L = 0.1\ \mu\text{F}$, $C_N = 0.1\ \mu\text{F}$		50		μs

TK11930 ELECTRICAL CHARACTERISTICS

Test conditions: $V_{IN} = 4.0\text{ V}$, $C_L = 10\ \mu\text{F}$, $C_N = 0.01\ \mu\text{F}$, $T_A = 25\ ^\circ\text{C}$, unless otherwise specified.

SYMBOL	PARAMETER	TEST CONDITIONS	MIN	TYP	MAX	UNITS
I_Q	Quiescent Current	$I_{OUT} = 0\ \text{mA}$		140	300	μA
		$V_{IN} = 2.0\ \text{V}$, $I_{OUT} = 0\ \text{mA}$		380	900	μA
I_{GND}	Ground Current	$I_{OUT} = 60\ \text{mA}$		2.5	10	mA
I_{STBY}	Standby Current	Output OFF		95	160	μA
V_{OUT}	Output Voltage	$I_{OUT} = 1\ \text{mA}$, $T_A = 25\ ^\circ\text{C}$	2.92	3.0	3.08	V
		$I_{OUT} = 1\ \text{mA}$, $-30 \leq T_A \leq 80\ ^\circ\text{C}$	2.88	3.0	3.12	V
V_{DROP}	Dropout Voltage	$I_{OUT} = 30\ \text{mA}$		160	350	mV
I_{OUT}	Output Current				100	mA
Line Reg	Line Regulation	$V_{IN} = 4.0\ \text{to}\ 13.0\ \text{V}$		5	50	mV
Load Reg	Load Regulation	$I_{OUT} = 1\ \text{to}\ 80\ \text{mA}$		20	100	mV
$\Delta V_{OUT}/\Delta T$	Temperature Coefficient			± 0.2		$\text{mV}/^\circ\text{C}$
RR	Ripple Rejection	$f = 400\ \text{Hz}$, $C_L = 10\ \mu\text{F}$		68		dB
V_{NO}	Output Noise Voltage	$10\ \text{Hz} \leq f \leq 100\ \text{kHz}$, $C_L = 10\ \mu\text{F}$, $C_N = 0.01\ \mu\text{F}$		50		μVrms
V_{DET}	Low Voltage Detector Threshold		$V_{OUT} \times 0.95$			V
$V_{DET(ERR)}$	Voltage Detector Threshold Tolerance		-4	V_{DET}	+4	%
V_{RESET}	Saturation Voltage	$I_{FLAG} = 100\ \mu\text{A}$		0.2	0.4	V
CONTROL TERMINAL SPECIFICATIONS						
I_{CONT}	Control Terminal Current	$V_{CONT} = 5\ \text{V}$		25	100	μA
		$V_{CONT} = 16\ \text{V}$		45	150	μA
$V_{CONT(ON)}$	Control Voltage (ON)	Output ON			0.6	V
$V_{CONT(OFF)}$	Control Voltage (OFF)	Output OFF	2.4			V
T_R	Output Rise Time (OFF to ON)	$I_{OUT} = 30\ \text{mA}$, $C_L = 0.1\ \mu\text{F}$, $C_N = 0.1\ \mu\text{F}$		50		μs

TK11932 ELECTRICAL CHARACTERISTICS

Test conditions: $V_{IN} = 4.25\text{ V}$, $C_L = 10\ \mu\text{F}$, $C_N = 0.01\ \mu\text{F}$, $T_A = 25\ ^\circ\text{C}$, unless otherwise specified.

SYMBOL	PARAMETER	TEST CONDITIONS	MIN	TYP	MAX	UNITS
I_Q	Quiescent Current	$I_{OUT} = 0\ \text{mA}$		140	300	μA
		$V_{IN} = 2.25\ \text{V}$, $I_{OUT} = 0\ \text{mA}$		380	900	μA
I_{GND}	Ground Current	$I_{OUT} = 60\ \text{mA}$		2.5	10	mA
I_{STBY}	Standby Current	Output OFF		95	160	μA
V_{OUT}	Output Voltage	$I_{OUT} = 1\ \text{mA}$, $T_A = 25\ ^\circ\text{C}$	3.17	3.25	3.33	V
		$I_{OUT} = 1\ \text{mA}$, $-30 \leq T_A \leq 80\ ^\circ\text{C}$	3.13	3.25	3.37	V
V_{DROP}	Dropout Voltage	$I_{OUT} = 30\ \text{mA}$		160	350	mV
I_{OUT}	Output Current				100	mA
Line Reg	Line Regulation	$V_{IN} = 4.25\ \text{to}\ 13.25\ \text{V}$		5	50	mV
Load Reg	Load Regulation	$I_{OUT} = 1\ \text{to}\ 80\ \text{mA}$		20	100	mV
$\Delta V_{OUT}/\Delta T$	Temperature Coefficient			± 0.2		$\text{mV}/^\circ\text{C}$
RR	Ripple Rejection	$f = 400\ \text{Hz}$, $C_L = 10\ \mu\text{F}$		68		dB
V_{NO}	Output Noise Voltage	$10\ \text{Hz} \leq f \leq 100\ \text{kHz}$, $C_L = 10\ \mu\text{F}$, $C_N = 0.01\ \mu\text{F}$		50		μVrms
V_{DET}	Low Voltage Detector Threshold			$V_{OUT} \times 0.95$		V
$V_{DET(ERR)}$	Voltage Detector Threshold Tolerance		-4	V_{DET}	+4	%
V_{RESET}	Saturation Voltage	$I_{FLAG} = 100\ \mu\text{A}$		0.2	0.4	V
CONTROL TERMINAL SPECIFICATIONS						
I_{CONT}	Control Terminal Current	$V_{CONT} = 5\ \text{V}$		25	100	μA
		$V_{CONT} = 16\ \text{V}$		45	150	μA
$V_{CONT(ON)}$	Control Voltage (ON)	Output ON			0.6	V
$V_{CONT(OFF)}$	Control Voltage (OFF)	Output OFF	2.4			V
T_R	Output Rise Time (OFF to ON)	$I_{OUT} = 30\ \text{mA}$, $C_L = 0.1\ \mu\text{F}$, $C_N = 0.1\ \mu\text{F}$		50		μs

TK11935 ELECTRICAL CHARACTERISTICS

Test conditions: $V_{IN} = 4.5\text{ V}$, $C_L = 10\ \mu\text{F}$, $C_N = 0.01\ \mu\text{F}$, $T_A = 25\ ^\circ\text{C}$, unless otherwise specified.

SYMBOL	PARAMETER	TEST CONDITIONS	MIN	TYP	MAX	UNITS
I_Q	Quiescent Current	$I_{OUT} = 0\ \text{mA}$		140	300	μA
		$V_{IN} = 2.5\ \text{V}$, $I_{OUT} = 0\ \text{mA}$		380	900	μA
I_{GND}	Ground Current	$I_{OUT} = 60\ \text{mA}$		2.5	10	mA
I_{STBY}	Standby Current	Output OFF		95	160	μA
V_{OUT}	Output Voltage	$I_{OUT} = 1\ \text{mA}$, $T_A = 25\ ^\circ\text{C}$	3.41	3.50	3.59	V
		$I_{OUT} = 1\ \text{mA}$, $-30 \leq T_A \leq 80\ ^\circ\text{C}$	3.37	3.50	3.63	V
V_{DROP}	Dropout Voltage	$I_{OUT} = 30\ \text{mA}$		160	350	mV
I_{OUT}	Output Current				100	mA
Line Reg	Line Regulation	$V_{IN} = 4.5\ \text{to}\ 13.5\ \text{V}$		5	50	mV
Load Reg	Load Regulation	$I_{OUT} = 1\ \text{to}\ 80\ \text{mA}$		20	100	mV
$\Delta V_{OUT}/\Delta T$	Temperature Coefficient			± 0.2		$\text{mV}/^\circ\text{C}$
RR	Ripple Rejection	$f = 400\ \text{Hz}$, $C_L = 10\ \mu\text{F}$		68		dB
V_{NO}	Output Noise Voltage	$10\ \text{Hz} \leq f \leq 100\ \text{kHz}$, $C_L = 10\ \mu\text{F}$, $C_N = 0.01\ \mu\text{F}$		50		μVrms
V_{DET}	Low Voltage Detector Threshold		$V_{OUT} \times 0.95$			V
$V_{DET(ERR)}$	Voltage Detector Threshold Tolerance		-4	V_{DET}	+4	%
V_{RESET}	Saturation Voltage	$I_{FLAG} = 100\ \mu\text{A}$		0.2	0.4	V
CONTROL TERMINAL SPECIFICATIONS						
I_{CONT}	Control Terminal Current	$V_{CONT} = 5\ \text{V}$		25	100	μA
		$V_{CONT} = 16\ \text{V}$		45	150	μA
$V_{CONT(ON)}$	Control Voltage (ON)	Output ON			0.6	V
$V_{CONT(OFF)}$	Control Voltage (OFF)	Output OFF	2.4			V
T_R	Output Rise Time (OFF to ON)	$I_{OUT} = 30\ \text{mA}$, $C_L = 0.1\ \mu\text{F}$, $C_N = 0.1\ \mu\text{F}$		50		μs

TK11940 ELECTRICAL CHARACTERISTICS

Test conditions: $V_{IN} = 5.0\text{ V}$, $C_L = 10\ \mu\text{F}$, $C_N = 0.01\ \mu\text{F}$, $T_A = 25\ ^\circ\text{C}$, unless otherwise specified.

SYMBOL	PARAMETER	TEST CONDITIONS	MIN	TYP	MAX	UNITS
I_Q	Quiescent Current	$I_{OUT} = 0\text{ mA}$		140	300	μA
		$V_{IN} = 3.0\text{ V}$, $I_{OUT} = 0\text{ mA}$		380	900	μA
I_{GND}	Ground Current	$I_{OUT} = 60\text{ mA}$		2.5	10	mA
I_{STBY}	Standby Current	Output OFF		95	160	μA
V_{OUT}	Output Voltage	$I_{OUT} = 1\text{ mA}$, $T_A = 25\ ^\circ\text{C}$	3.90	4.00	4.10	V
		$I_{OUT} = 1\text{ mA}$, $-30 \leq T_A \leq 80\ ^\circ\text{C}$	3.86	4.00	4.14	V
V_{DROP}	Dropout Voltage	$I_{OUT} = 30\text{ mA}$		160	350	mV
I_{OUT}	Output Current				100	mA
Line Reg	Line Regulation	$V_{IN} = 5.0\text{ to }14.0\text{ V}$		5	50	mV
Load Reg	Load Regulation	$I_{OUT} = 1\text{ to }80\text{ mA}$		20	100	mV
$\Delta V_{OUT}/\Delta T$	Temperature Coefficient			± 0.2		$\text{mV}/^\circ\text{C}$
RR	Ripple Rejection	$f = 400\text{ Hz}$, $C_L = 10\ \mu\text{F}$		68		dB
V_{NO}	Output Noise Voltage	$10\text{ Hz} \leq f \leq 100\text{ kHz}$, $C_L = 10\ \mu\text{F}$, $C_N = 0.01\ \mu\text{F}$		50		μVrms
V_{DET}	Low Voltage Detector Threshold			$V_{OUT} \times 0.95$		V
$V_{DET(ERR)}$	Voltage Detector Threshold Tolerance		-4	V_{DET}	+4	%
V_{RESET}	Saturation Voltage	$I_{FLAG} = 100\ \mu\text{A}$		0.2	0.4	V
CONTROL TERMINAL SPECIFICATIONS						
I_{CONT}	Control Terminal Current	$V_{CONT} = 5\text{ V}$		25	100	μA
		$V_{CONT} = 16\text{ V}$		45	150	μA
$V_{CONT(ON)}$	Control Voltage (ON)	Output ON			0.6	V
$V_{CONT(OFF)}$	Control Voltage (OFF)	Output OFF	2.4			V
T_R	Output Rise Time (OFF to ON)	$I_{OUT} = 30\text{ mA}$, $C_L = 0.1\ \mu\text{F}$, $C_N = 0.1\ \mu\text{F}$		50		μs

TK11948 ELECTRICAL CHARACTERISTICS

Test conditions: $V_{IN} = 5.8\text{ V}$, $C_L = 10\ \mu\text{F}$, $C_N = 0.01\ \mu\text{F}$, $T_A = 25\ ^\circ\text{C}$, unless otherwise specified.

SYMBOL	PARAMETER	TEST CONDITIONS	MIN	TYP	MAX	UNITS
I_Q	Quiescent Current	$I_{OUT} = 0\ \text{mA}$		140	300	μA
		$V_{IN} = 3.8\ \text{V}$, $I_{OUT} = 0\ \text{mA}$		380	900	μA
I_{GND}	Ground Current	$I_{OUT} = 60\ \text{mA}$		2.5	10	mA
I_{STBY}	Standby Current	Output OFF		95	160	μA
V_{OUT}	Output Voltage	$I_{OUT} = 1\ \text{mA}$, $T_A = 25\ ^\circ\text{C}$	4.68	4.80	4.92	V
		$I_{OUT} = 1\ \text{mA}$, $-30 \leq T_A \leq 80\ ^\circ\text{C}$	4.63	4.80	4.97	V
V_{DROP}	Dropout Voltage	$I_{OUT} = 30\ \text{mA}$		160	350	mV
I_{OUT}	Output Current				100	mA
Line Reg	Line Regulation	$V_{IN} = 5.8\ \text{to}\ 14.8\ \text{V}$		5	50	mV
Load Reg	Load Regulation	$I_{OUT} = 1\ \text{to}\ 80\ \text{mA}$		20	100	mV
$\Delta V_{OUT}/\Delta T$	Temperature Coefficient			± 0.2		$\text{mV}/^\circ\text{C}$
RR	Ripple Rejection	$f = 400\ \text{Hz}$, $C_L = 10\ \mu\text{F}$		68		dB
V_{NO}	Output Noise Voltage	$10\ \text{Hz} \leq f \leq 100\ \text{kHz}$, $C_L = 10\ \mu\text{F}$, $C_N = 0.01\ \mu\text{F}$		50		μVrms
V_{DET}	Low Voltage Detector Threshold			$V_{OUT} \times 0.95$		V
$V_{DET(ERR)}$	Voltage Detector Threshold Tolerance		-4	V_{DET}	+4	%
V_{RESET}	Saturation Voltage	$I_{FLAG} = 100\ \mu\text{A}$		0.2	0.4	V
CONTROL TERMINAL SPECIFICATIONS						
I_{CONT}	Control Terminal Current	$V_{CONT} = 5\ \text{V}$		25	100	μA
		$V_{CONT} = 16\ \text{V}$		45	150	μA
$V_{CONT(ON)}$	Control Voltage (ON)	Output ON			0.6	V
$V_{CONT(OFF)}$	Control Voltage (OFF)	Output OFF	2.4			V
T_R	Output Rise Time (OFF to ON)	$I_{OUT} = 30\ \text{mA}$, $C_L = 0.1\ \mu\text{F}$, $C_N = 0.1\ \mu\text{F}$		50		μs

TK11950 ELECTRICAL CHARACTERISTICS

Test conditions: $V_{IN} = 6.0\text{ V}$, $C_L = 10\ \mu\text{F}$, $C_N = 0.01\ \mu\text{F}$, $T_A = 25\ ^\circ\text{C}$, unless otherwise specified.

SYMBOL	PARAMETER	TEST CONDITIONS	MIN	TYP	MAX	UNITS
I_Q	Quiescent Current	$I_{OUT} = 0\text{ mA}$		140	300	μA
		$V_{IN} = 4.0\text{ V}$, $I_{OUT} = 0\text{ mA}$		380	900	μA
I_{GND}	Ground Current	$I_{OUT} = 60\text{ mA}$		2.5	10	mA
I_{STBY}	Standby Current	Output OFF		95	160	μA
V_{OUT}	Output Voltage	$I_{OUT} = 1\text{ mA}$, $T_A = 25\ ^\circ\text{C}$	4.875	5.000	5.125	V
		$I_{OUT} = 1\text{ mA}$, $-30 \leq T_A \leq 80\ ^\circ\text{C}$	4.825	5.000	5.175	V
V_{DROP}	Dropout Voltage	$I_{OUT} = 30\text{ mA}$		160	350	mV
I_{OUT}	Output Current				100	mA
Line Reg	Line Regulation	$V_{IN} = 6.0\text{ to }15.0\text{ V}$		5	50	mV
Load Reg	Load Regulation	$I_{OUT} = 1\text{ to }80\text{ mA}$		20	100	mV
$\Delta V_{OUT}/\Delta T$	Temperature Coefficient			± 0.2		$\text{mV}/^\circ\text{C}$
RR	Ripple Rejection	$f = 400\text{ Hz}$, $C_L = 10\ \mu\text{F}$		68		dB
V_{NO}	Output Noise Voltage	$10\text{ Hz} \leq f \leq 100\text{ kHz}$, $C_L = 10\ \mu\text{F}$, $C_N = 0.01\ \mu\text{F}$		50		μVrms
V_{DET}	Low Voltage Detector Threshold			$V_{OUT} \times 0.95$		V
$V_{DET(ERR)}$	Voltage Detector Threshold Tolerance		-4	V_{DET}	+4	%
V_{RESET}	Saturation Voltage	$I_{FLAG} = 100\ \mu\text{A}$		0.2	0.4	V
CONTROL TERMINAL SPECIFICATIONS						
I_{CONT}	Control Terminal Current	$V_{CONT} = 5\text{ V}$		25	100	μA
		$V_{CONT} = 16\text{ V}$		45	150	μA
$V_{CONT(ON)}$	Control Voltage (ON)	Output ON			0.6	V
$V_{CONT(OFF)}$	Control Voltage (OFF)	Output OFF	2.4			V
T_R	Output Rise Time (OFF to ON)	$I_{OUT} = 30\text{ mA}$, $C_L = 0.1\ \mu\text{F}$, $C_N = 0.1\ \mu\text{F}$		50		μs

TEST CIRCUIT

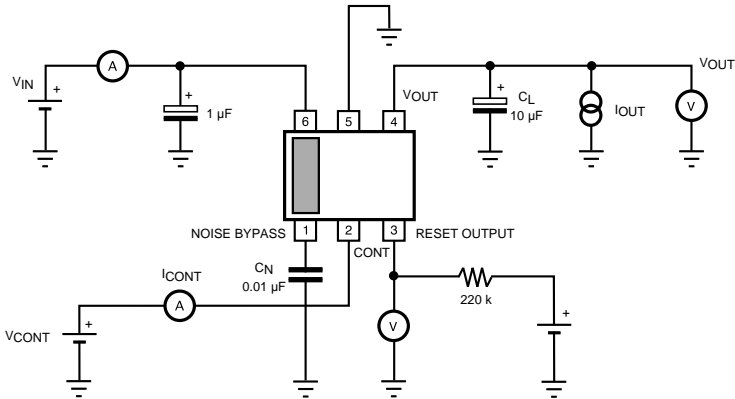

**TIMING DIAGRAM
PRINCIPLE OF OPERATION**

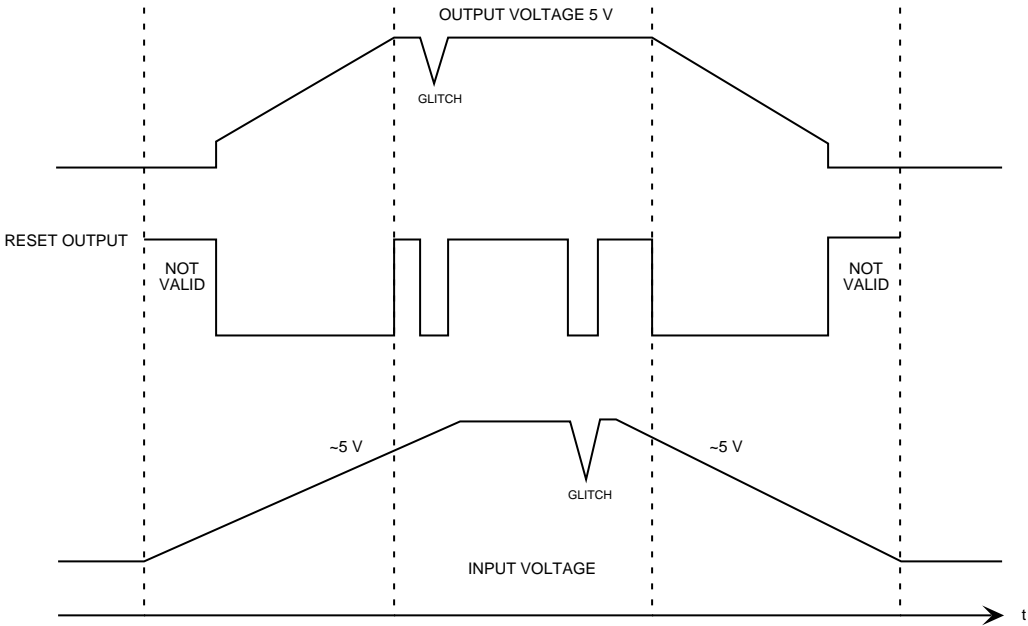

TYPICAL PERFORMANCE CHARACTERISTICS

$T_A = 25\text{ }^\circ\text{C}$, unless otherwise specified.

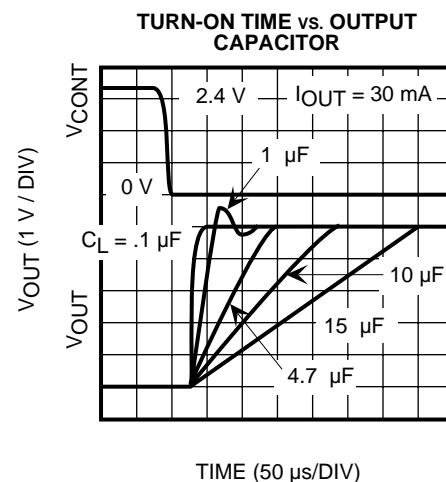
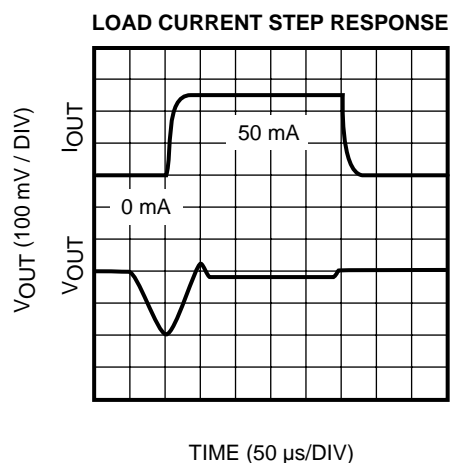
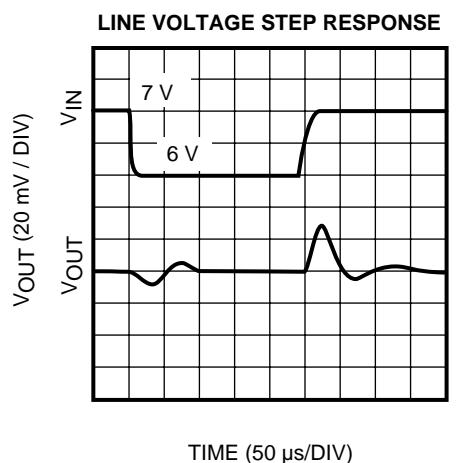
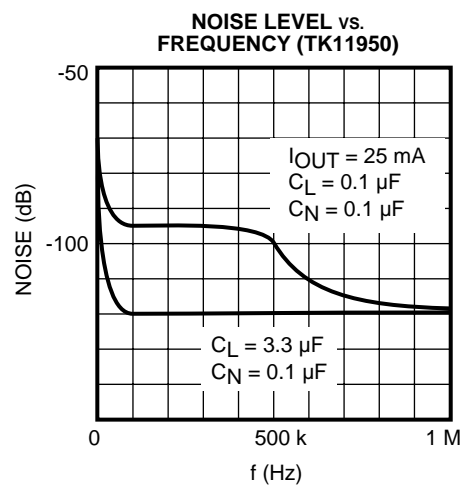
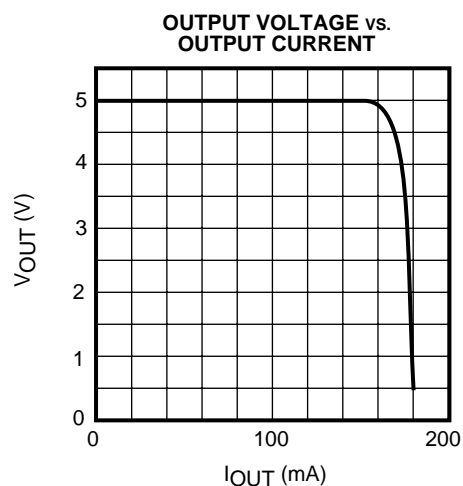
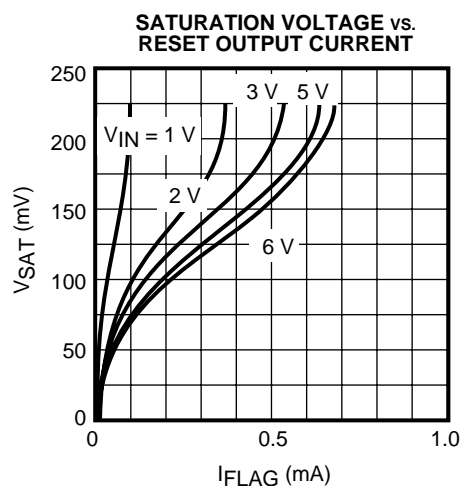
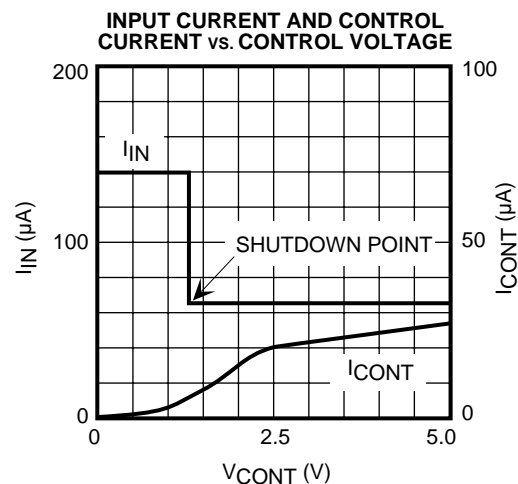
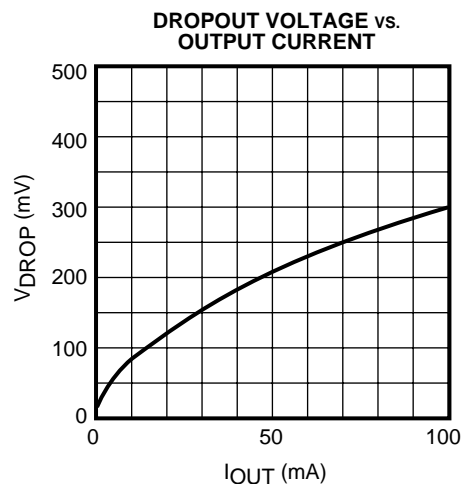
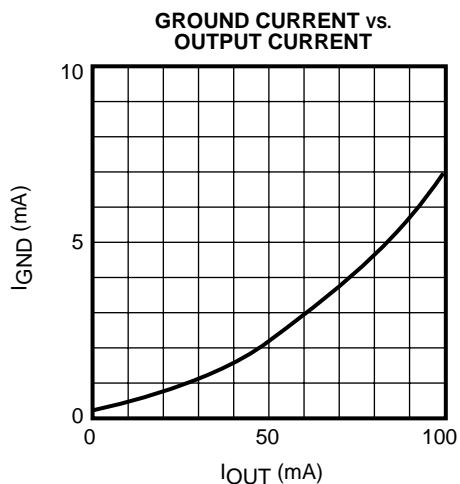

TYPICAL PERFORMANCE CHARACTERISTICS (CONT.)

$T_A = 25\text{ }^\circ\text{C}$, unless otherwise specified.

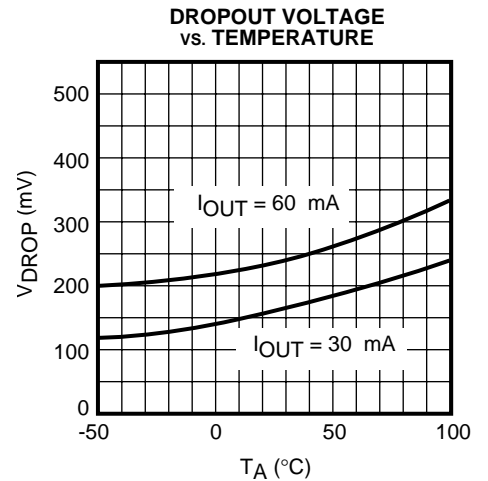
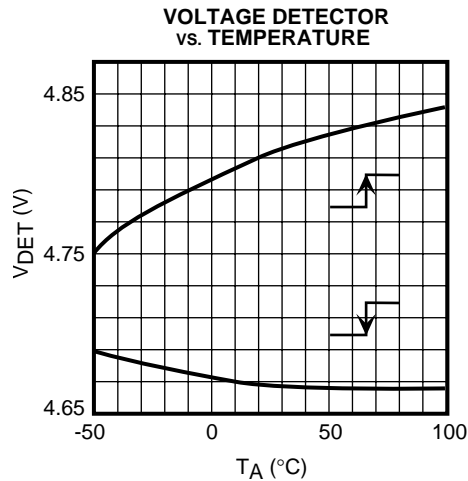
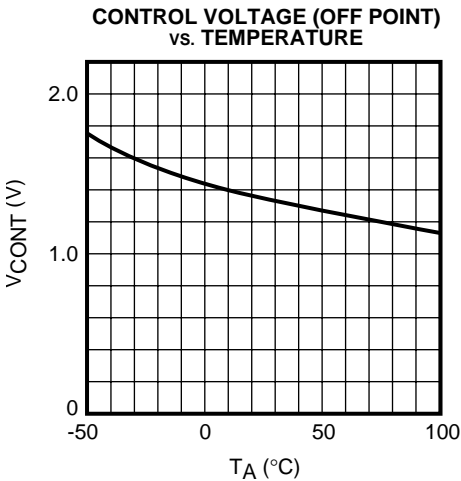
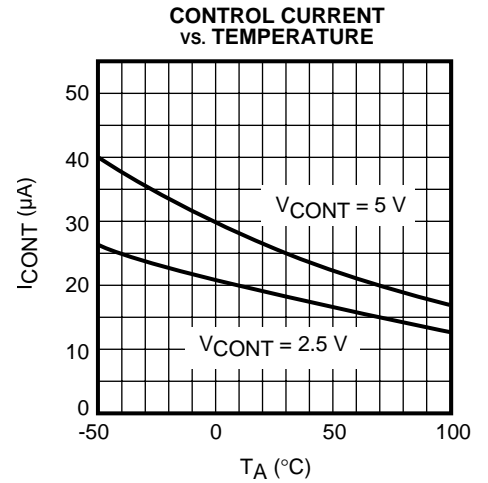
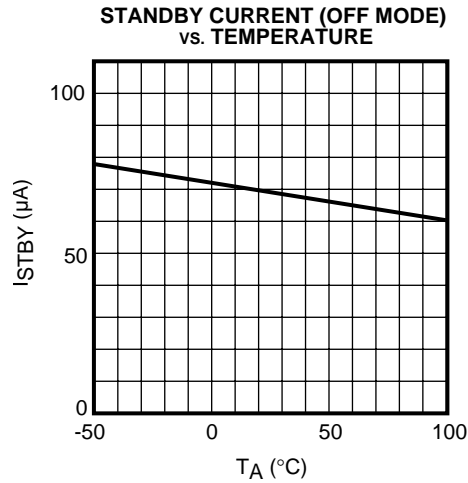
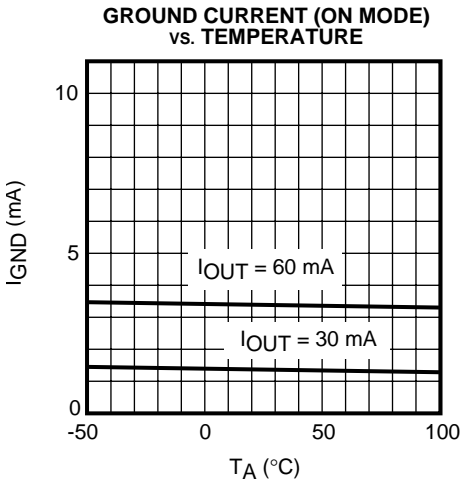
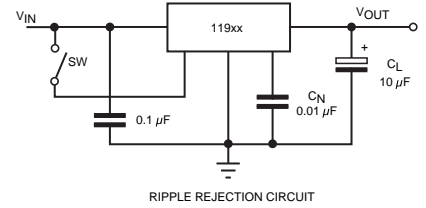
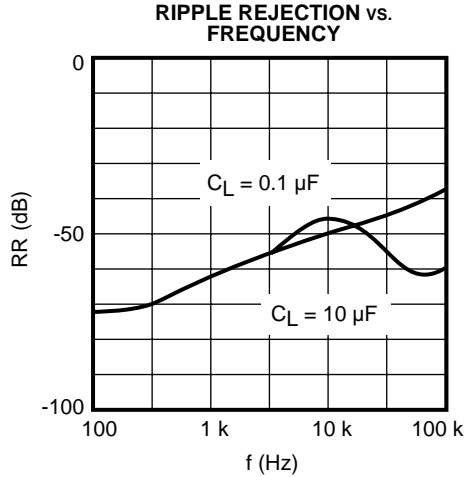
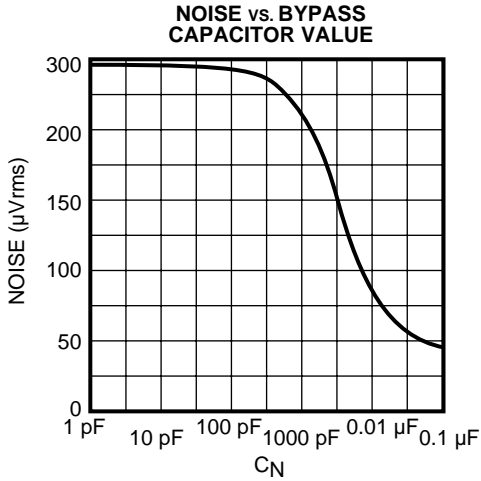

TYPICAL PERFORMANCE CHARACTERISTICS (CONT.)

$T_A = 25\text{ }^\circ\text{C}$, unless otherwise specified.

TK11922

OUTPUT VOLTAGE vs. OUTPUT CURRENT

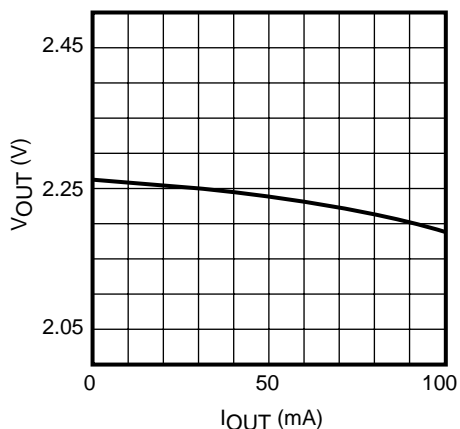

OUTPUT VOLTAGE vs. INPUT VOLTAGE

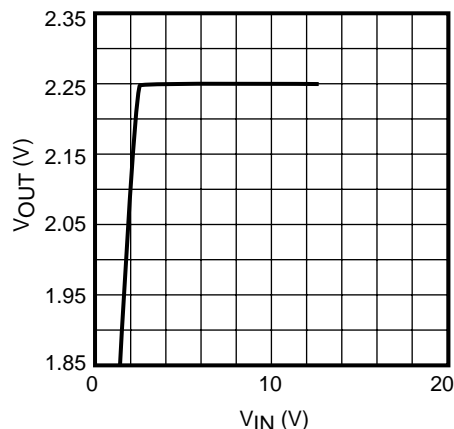

LOW VOLTAGE DETECTOR vs. INPUT VOLTAGE

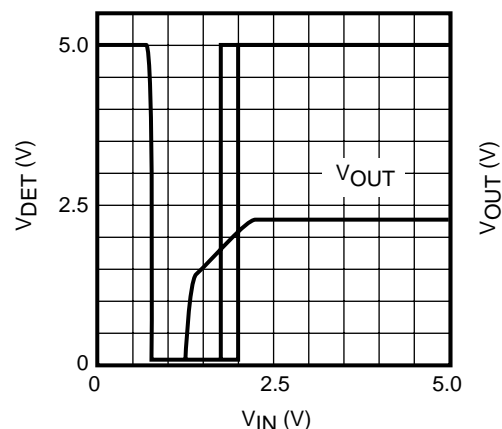

QUIESCENT CURRENT vs. INPUT VOLTAGE

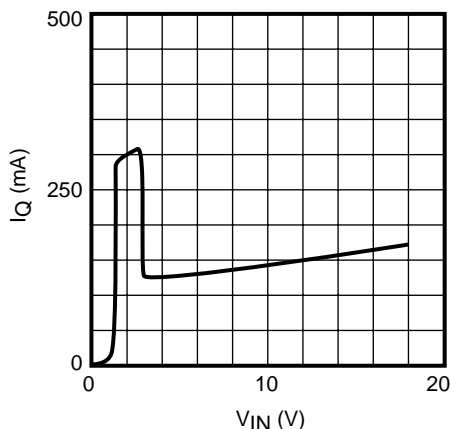

OUTPUT VOLTAGE vs. INPUT VOLTAGE

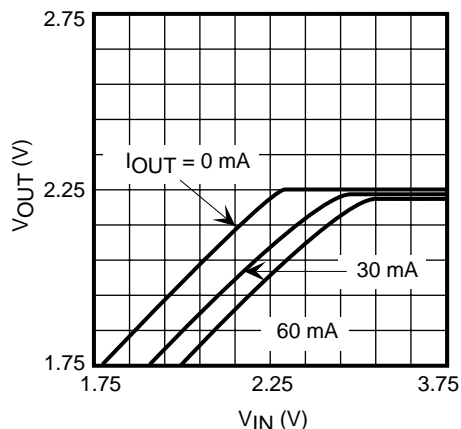

OUTPUT VOLTAGE vs. AMBIENT TEMPERATURE

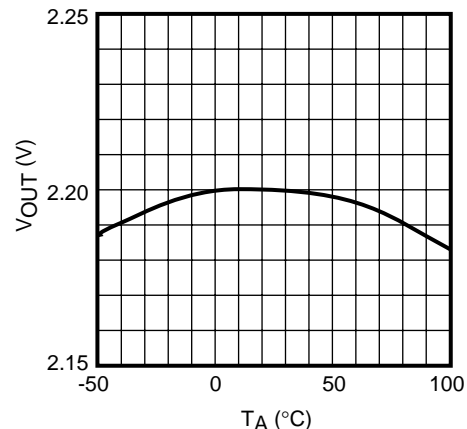

TK11927

OUTPUT VOLTAGE vs. OUTPUT CURRENT

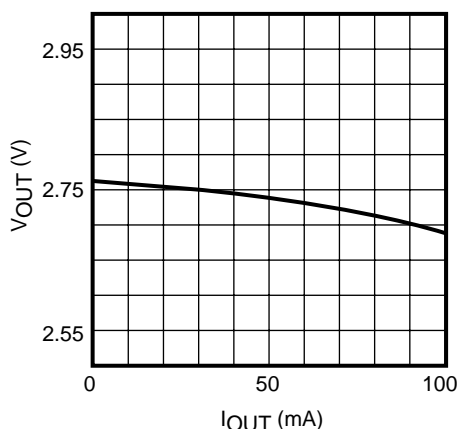

OUTPUT VOLTAGE vs. INPUT VOLTAGE

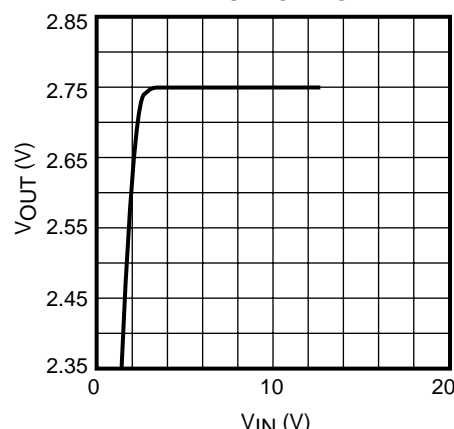

LOW VOLTAGE DETECTOR vs. INPUT VOLTAGE

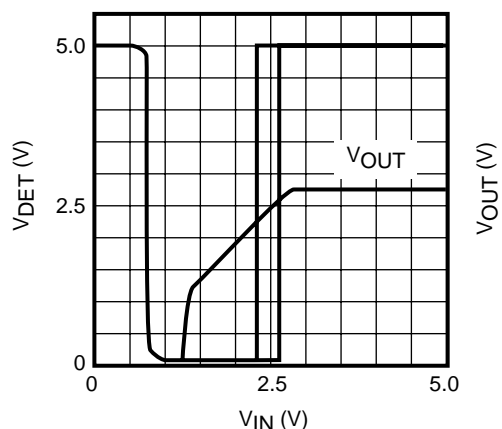

TYPICAL PERFORMANCE CHARACTERISTICS (CONT.)

$T_A = 25\text{ }^\circ\text{C}$, unless otherwise specified.

TK11927 (CONT.)

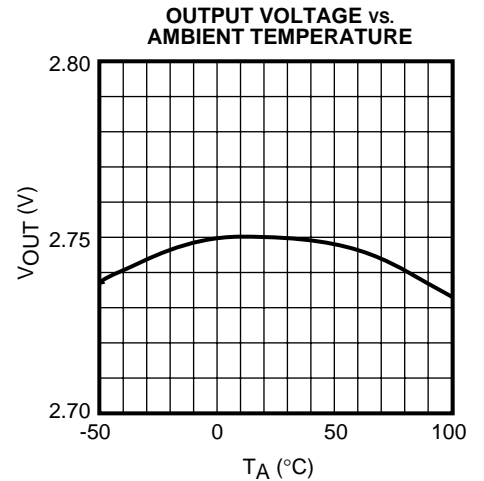
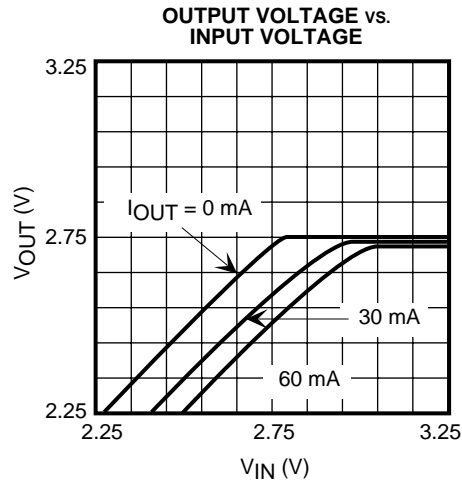
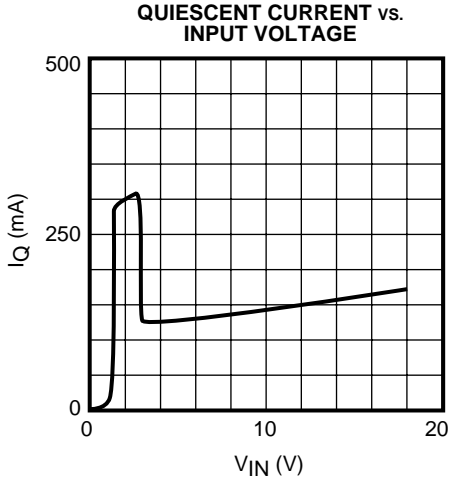

TK11930

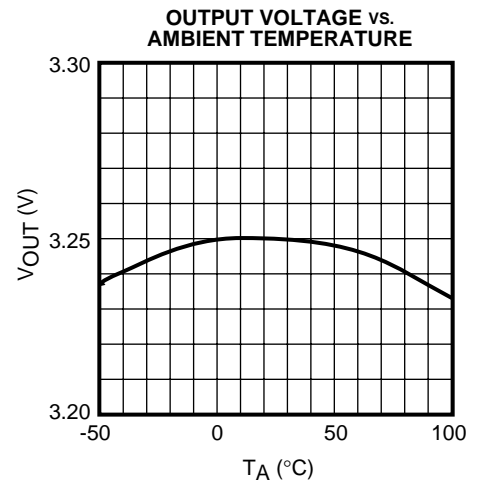
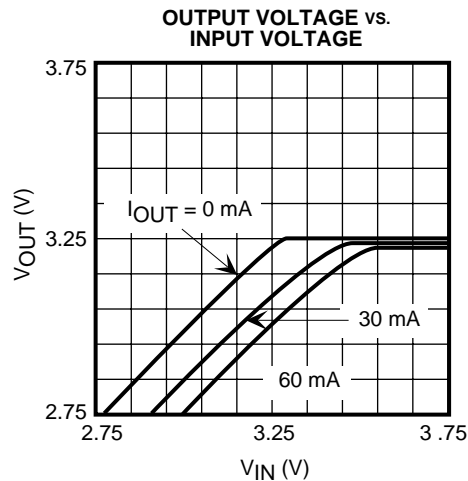
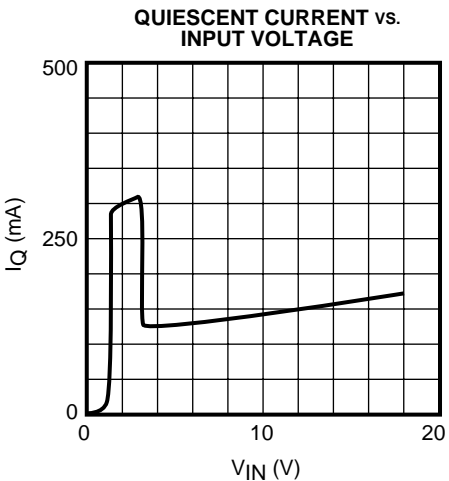
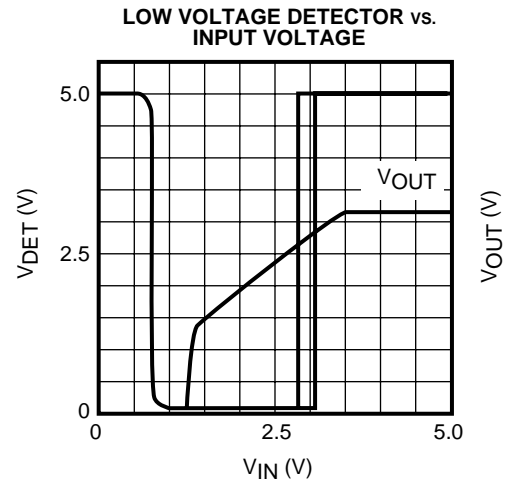
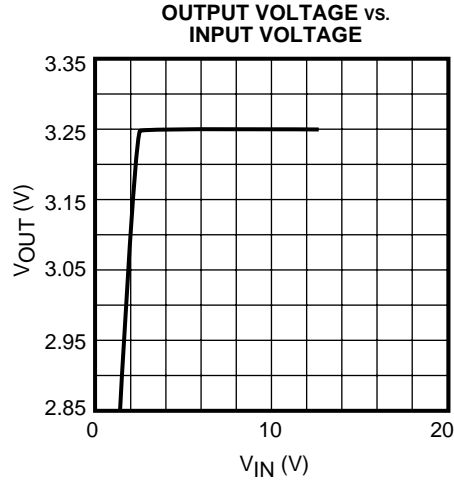
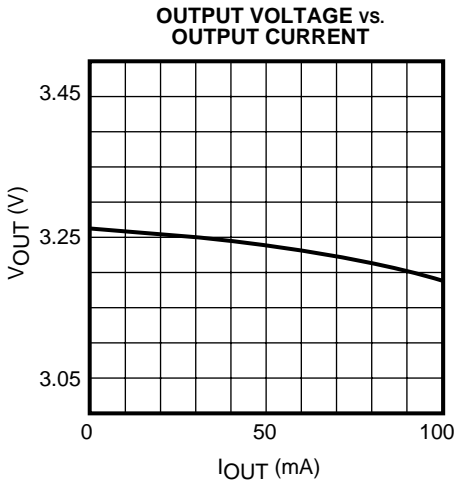

TYPICAL PERFORMANCE CHARACTERISTICS (CONT.)

$T_A = 25\text{ }^\circ\text{C}$, unless otherwise specified.

TK11932

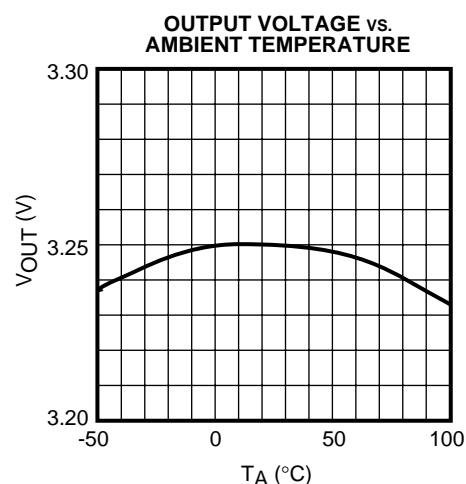
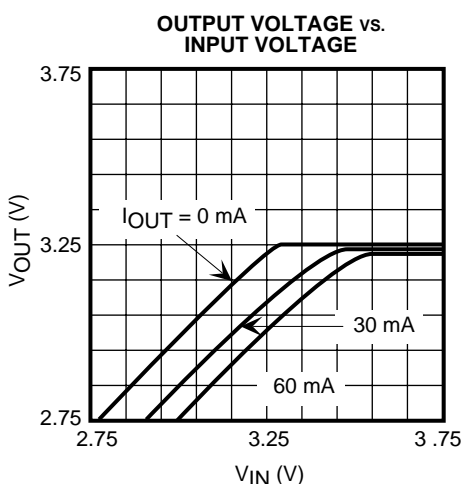
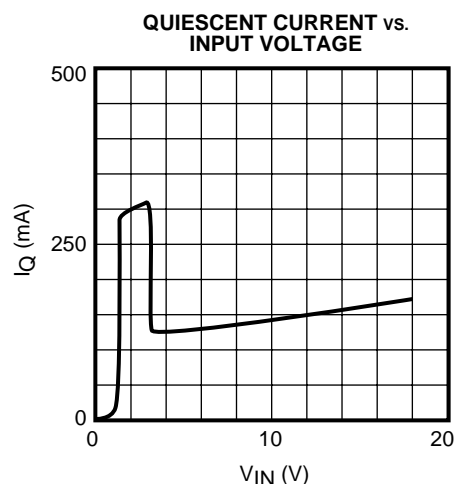
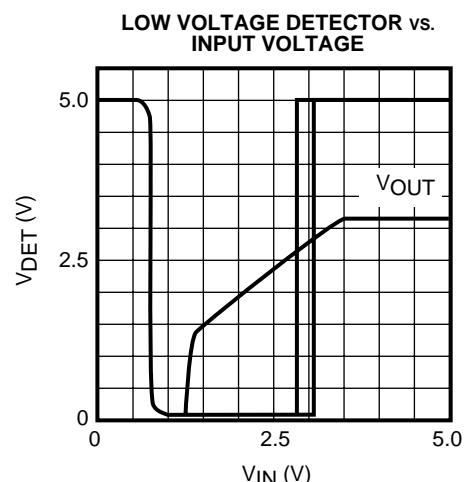
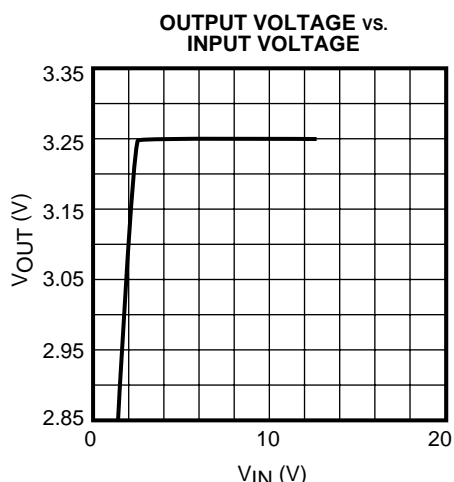
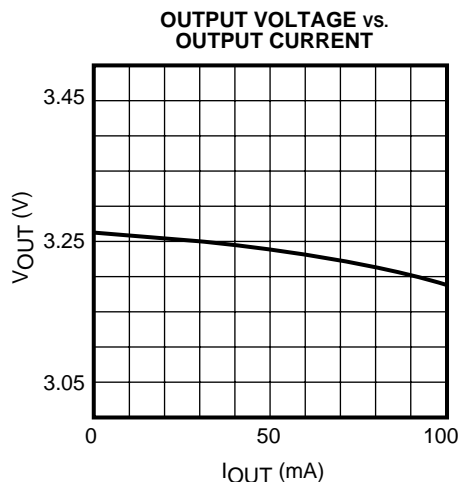

TK11935

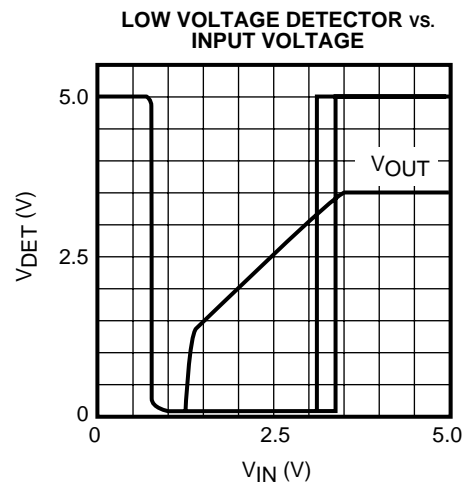
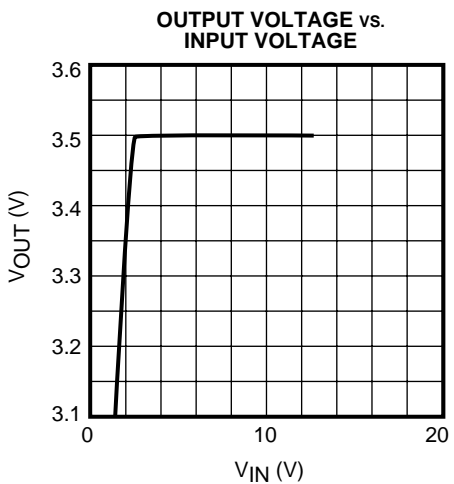
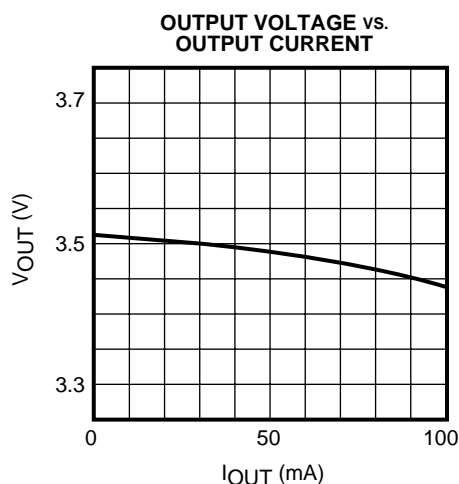

TYPICAL PERFORMANCE CHARACTERISTICS (CONT.)

$T_A = 25\text{ }^\circ\text{C}$, unless otherwise specified.

TK11935 (CONT.)

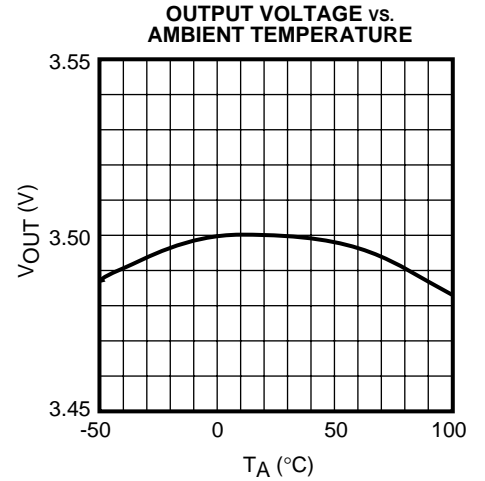
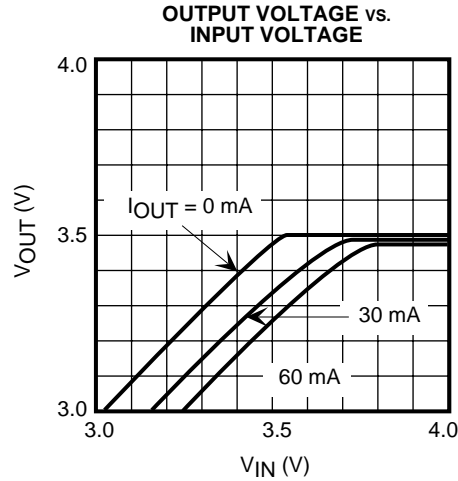
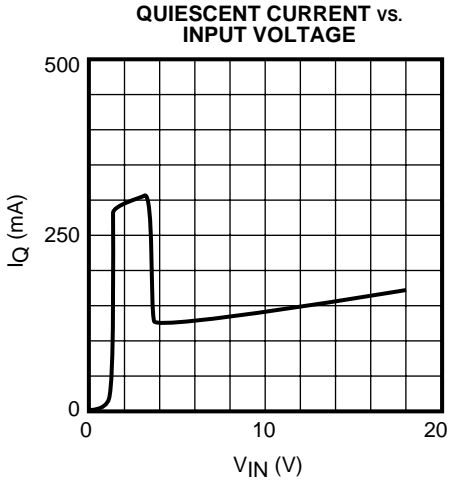

TK11940

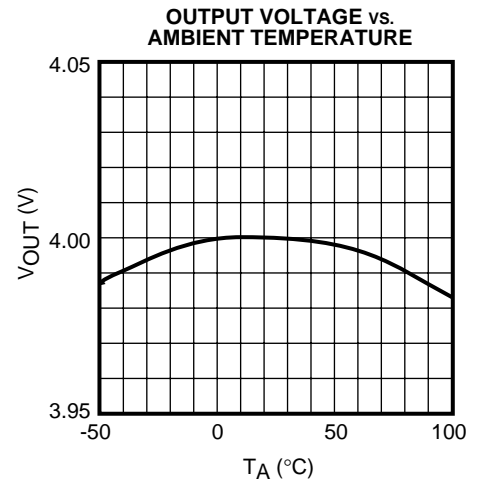
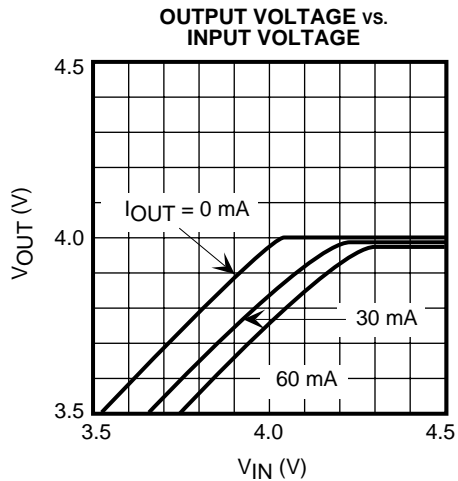
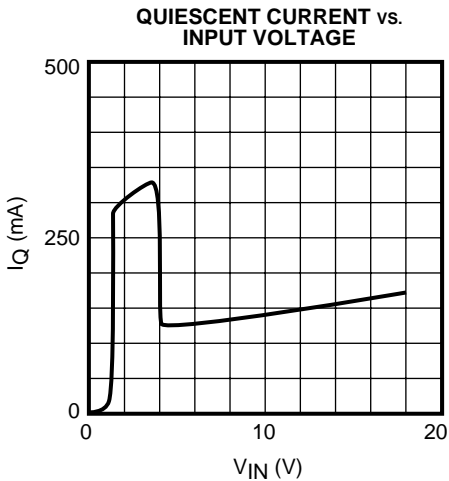
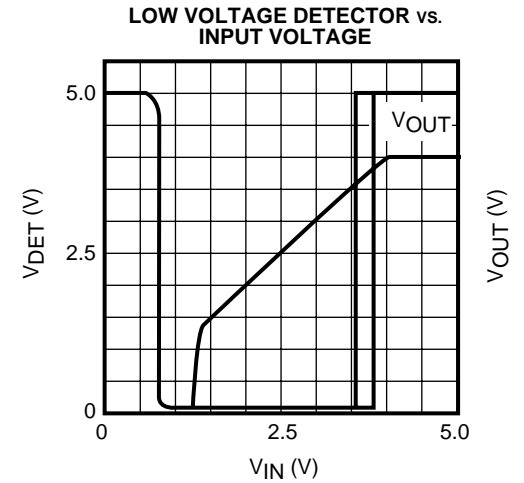
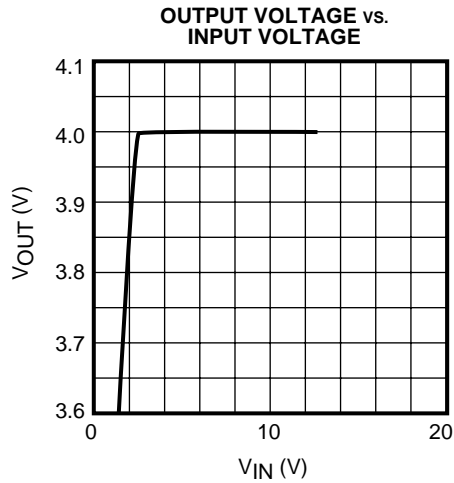
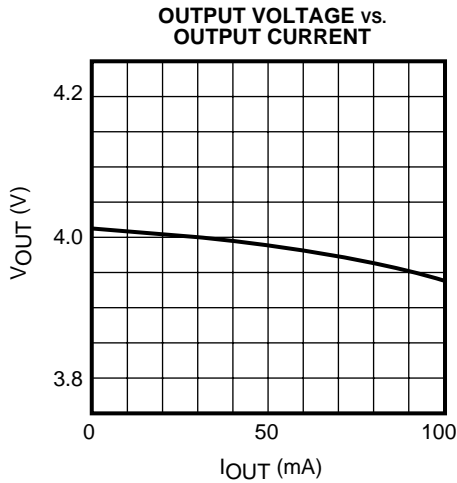

TYPICAL PERFORMANCE CHARACTERISTICS (CONT.)

$T_A = 25\text{ }^\circ\text{C}$, unless otherwise specified.

TK11948

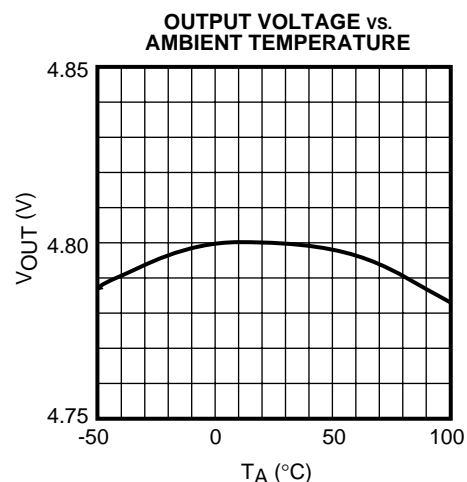
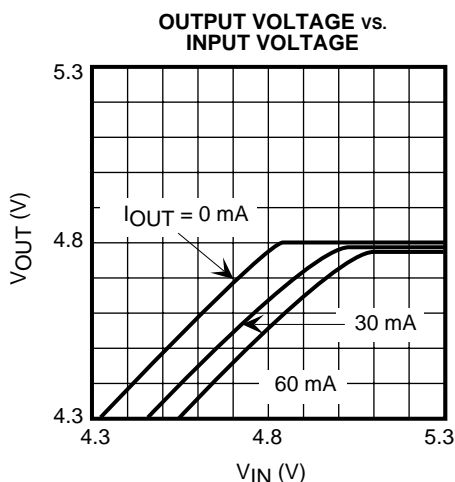
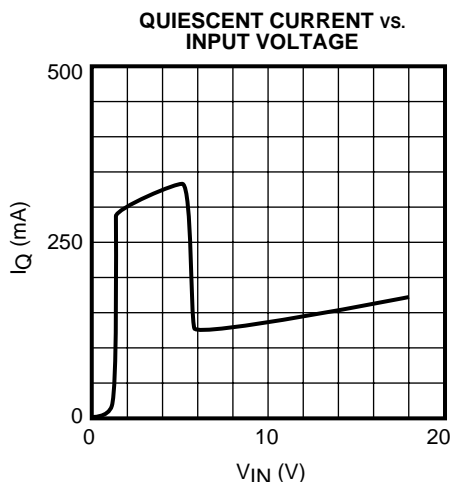
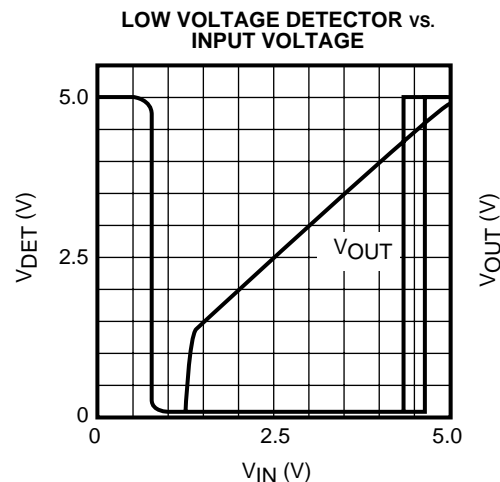
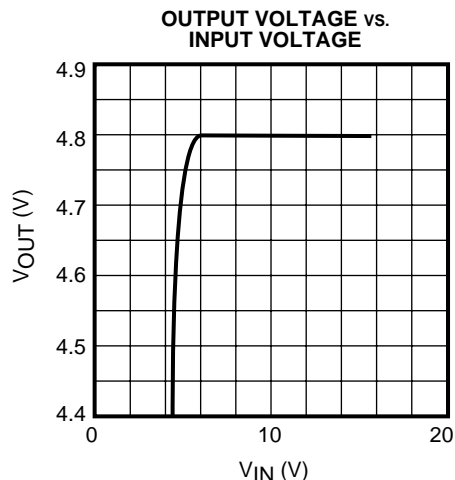
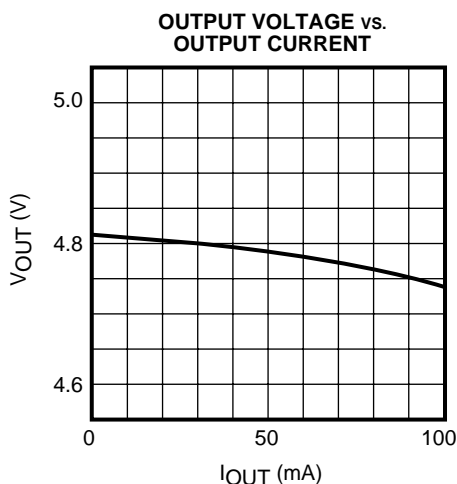

TK11950

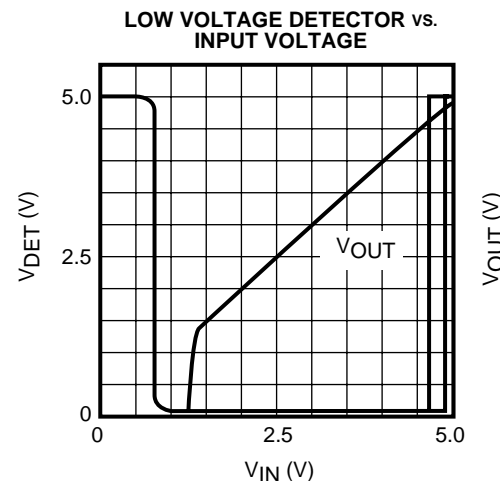
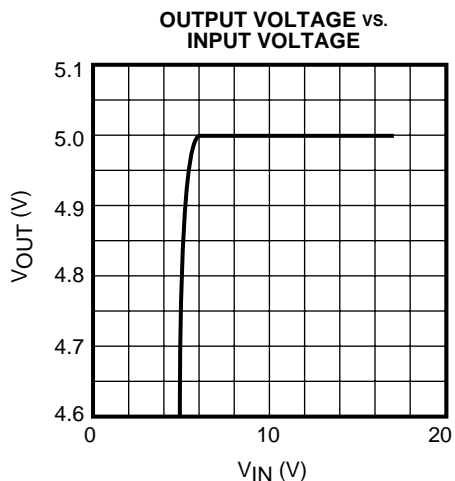
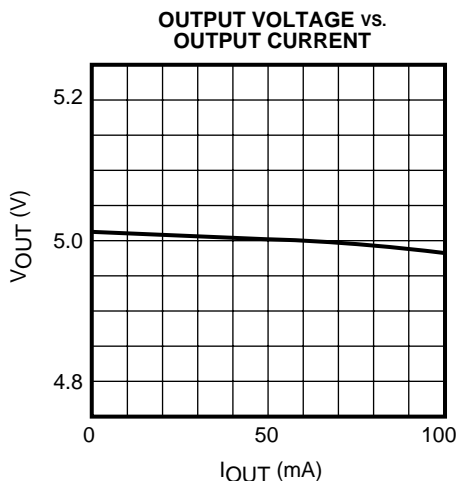

TYPICAL PERFORMANCE CHARACTERISTICS (CONT.)

$T_A = 25\text{ }^\circ\text{C}$, unless otherwise specified.

TK11950 (CONT.)

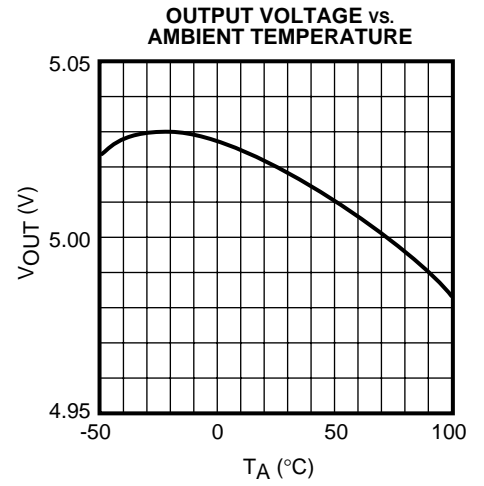
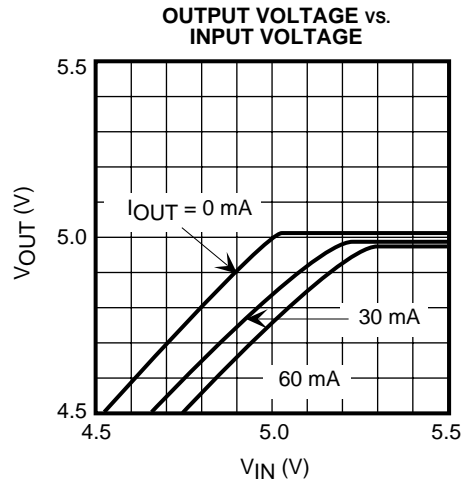
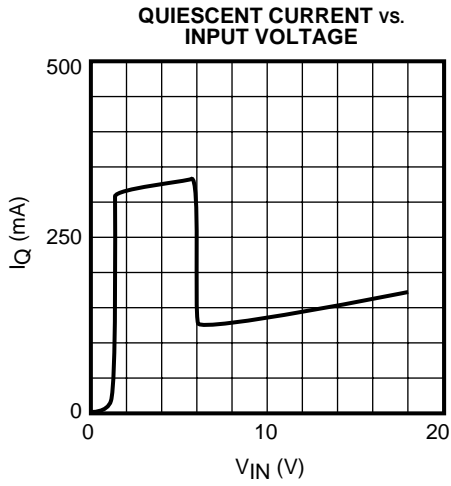

DEFINITION AND EXPLANATION OF TECHNICAL TERMS

QUIESCENT CURRENT (I_Q)

The quiescent current is the current which flows through the ground terminal under no load conditions ($I_{OUT} = 0$ mA).

GROUND CURRENT (I_{GND})

Ground current is the current which flows through the ground pin(s). It is defined as $I_{IN} - I_{OUT}$, excluding control current.

LINE REGULATION (LINE REG)

Line regulation is the relationship between change in output voltage due to a change in input voltage.

LOAD REGULATION (LOAD REG)

Load regulation is the relationship between change in output voltage due to a change in load current.

DROPOUT VOLTAGE (V_{DROP})

This is a measure of how well the regulator performs as the input voltage decreases. The smaller the number, the further the input voltage can decrease before regulation problems occur. Nominal output voltage is first measured when $V_{IN} = V_{OUT(TYP)} + 1$ at a chosen load current. When the output voltage has dropped 100 mV from the nominal, $V_{IN} - V_{OUT}$ is the dropout voltage. This voltage is affected by load current and junction temperature.

OUTPUT NOISE VOLTAGE

This is the effective AC voltage that occurs on the output voltage under the condition where the input noise is low and with a given load, filter capacitor, and frequency range.

THERMAL PROTECTION

This is an internal feature which turns the regulator off when the junction temperature rises above 150 °C. After the regulator turns off, the temperature drops and the regulator output turns back on. Under certain conditions, the output waveform may appear to be an oscillation as the output turns off and on and back again in succession.

PACKAGE POWER DISSIPATION (P_D)

This is the power dissipation level at which the thermal sensor is activated. The IC contains an internal thermal sensor which monitors the junction temperature. When the junction temperature exceeds the monitor threshold of 150 °C, the IC is shut down. The junction temperature rises as the difference between the input power ($V_{IN} \times I_{IN}$) and the output power ($V_{OUT} \times I_{OUT}$) increases. The rate of temperature rise is greatly affected by the mounting pad configuration on the PCB, the board material, and the ambient temperature. When the IC mounting has good thermal conductivity, the junction temperature will be low even if the power dissipation is great. When mounted on the recommended mounting pad, the power dissipation of the SOT-23L is increased to 400 mW. For operation at ambient temperatures over 25 °C, the power dissipation of the SOT-23L device should be derated at 3.2 mW/°C. To determine the power dissipation for shutdown when mounted, attach the device on the actual PCB and deliberately increase the output current (or raise the input voltage) until the thermal protection circuit is activated. Calculate the power dissipation of the device by subtracting the output power from the input power. These measurements should allow for the ambient temperature of the PCB. The value obtained from $P_D / (150\text{ °C} - T_A)$ is the derating factor. The PCB mounting pad should provide maximum thermal conductivity in order to maintain low device temperatures. As a general rule, the lower the temperature, the better the reliability of the device. The thermal resistance when mounted is expressed as follows:

$$T_j = \theta_{jA} \times P_D + T_A$$

For Toko ICs, the internal limit for junction temperature is 150 °C. If the ambient temperature (T_A) is 25 °C, then:

$$150\text{ °C} = \theta_{jA} \times P_D + 25\text{ °C}$$

$$\theta_{jA} = 125\text{ °C} / P_D$$

P_D is the value when the thermal sensor is activated. A simple way to determine P_D is to calculate $V_{IN} \times I_{IN}$ when the output side is shorted. Input current gradually falls as temperature rises. You should use the value when thermal equilibrium is reached.

DEFINITION AND EXPLANATION OF TECHNICAL TERMS (CONT.)

The range of usable currents can also be found from the graph below.

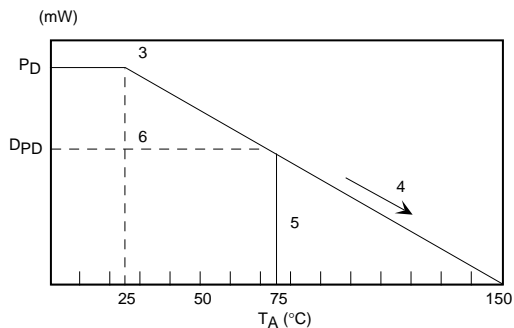

Procedure:

- 1) Find P_D
- 2) P_{D1} is taken to be $P_D \times (\sim 0.8 - 0.9)$
- 3) Plot P_{D1} against 25°C
- 4) Connect P_{D1} to the point corresponding to the 150°C with a straight line.
- 5) In design, take a vertical line from the maximum operating temperature (e.g., 75°C) to the derating curve.
- 6) Read off the value of P_D against the point at which the vertical line intersects the derating curve. This is taken as the maximum power dissipation, D_{PD} .

The maximum operating current is:

$$I_{\text{OUT}} = (D_{PD} / (V_{\text{IN(MAX)}} - V_{\text{OUT}}))$$

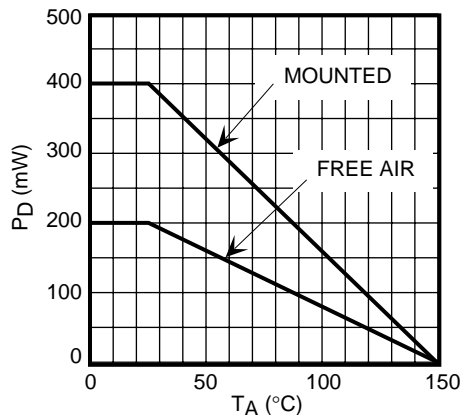

SOT-23L POWER DISSIPATION

APPLICATION INFORMATION

INPUT/OUTPUT DECOUPLING CAPACITOR CONSIDERATIONS

Voltage regulators require input and output decoupling capacitors. The required values of these capacitors vary with application. Capacitors made by different manufacturers can have different characteristics, particularly with regard to high frequencies and Equivalent Series Resistance (ESR) over temperature. The type of capacitor is also important. For example, a 4.7 μF aluminum electrolytic may be required for a certain application. If a tantalum capacitor is used, a lower value of 2.2 μF would be adequate. It is important to consider the temperature characteristics of the decoupling capacitors. While Toko regulators are designed to operate as low as $-30\text{ }^{\circ}\text{C}$, many capacitors will not operate properly at this temperature. The capacitance of aluminum electrolytic capacitors may decrease to 0 at low temperatures. This may cause oscillation on the output of the regulator since some capacitance is required to guarantee stability. Thus, it is important to consider the characteristics of the capacitor over temperature when selecting decoupling capacitors.

The ESR is another important parameter. The ESR will increase with temperature but low ESR capacitors are often larger and more costly. In general, tantalum capacitors offer lower ESR than aluminum electrolytic, but new low ESR aluminum electrolytic capacitors are now available from several manufacturers. Usually a bench test is sufficient to determine the minimum capacitance required for a particular application. After taking thermal characteristics and tolerance into account, the minimum capacitance value should be approximately two times the value. The recommended minimum capacitance for the TK119xx is 2.2 μF for a tantalum capacitor or 3.3 μF for an aluminum electrolytic. Please note that linear regulators with a low dropout voltage have high internal loop gains which require care in guarding against oscillation caused by insufficient decoupling capacitance. The use of high quality decoupling capacitors suited for your application will guarantee proper operation of the circuit.

BOARD LAYOUT

Copper pattern should be as large as possible. Power dissipation is 400 mW for the SOT-23L package. A low ESR capacitor is recommended. For low temperature operation, select a capacitor with a low ESR at the lowest operating temperature to prevent oscillation, degradation of ripple rejection and increase in noise. The minimum recommended capacitance is 2.2 μF .

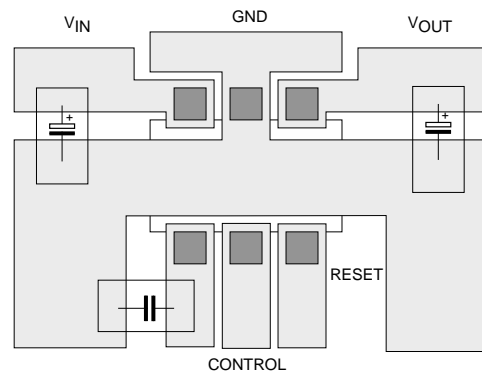

SOT-23L BOARD LAYOUT

NOISE BYPASS CAPACITOR SECTION

The noise bypass capacitor (C_N) should be connected as close as possible to pin 1 and ground. The recommended value for C_N is 0.01 μF . The noise bypass terminal has a high impedance and care should be taken if the noise bypass capacitor is not used. This terminal is susceptible to external noise, and oscillation can occur when C_N is not used and the solder pad for this pin is too large.

RESET OUTPUT CONSIDERATIONS

It is important to note the accuracy of the regulator and voltage detector functions when they are combined within one IC. The figure below illustrates the voltage regulator and voltage detector implemented with individual reference voltages.

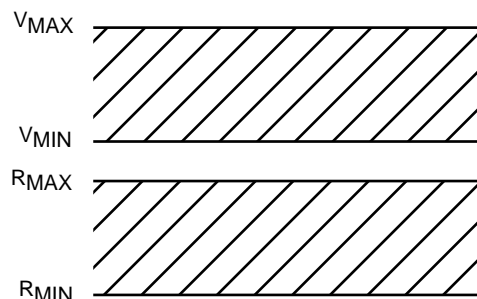

NON-TOKO APPROACH

APPLICATION INFORMATION (CONT.)

Note: $V_{MIN} - R_{MAX} \leq 0$ is possible, meaning the two ranges may overlap.

The figure below illustrates the TK119xx. The TK119xx utilizes the same reference voltage for both the voltage regulator and the voltage detector functions. As a result, the detector voltage is always constant ($V_{OUT} \times 0.95\%$) from the output voltage. With this approach, the two ranges do not overlap.

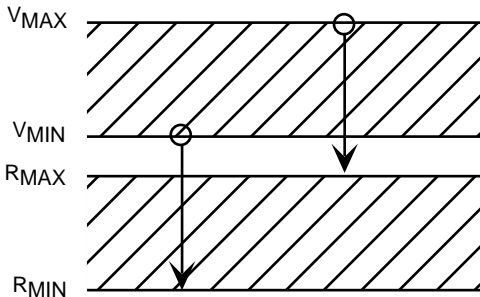

TOKO APPROACH

HANDLING MOLDED RESIN PACKAGES

All plastic molded packages absorb some moisture from the air. If moisture absorption occurs prior to soldering the device into the printed circuit board, increased separation of the lead from the plastic molding may occur, degrading the moisture barrier characteristics of the device. This property of plastic molding compounds should not be overlooked, particularly in the case of very small packages, where the plastic is very thin.

In order to preserve the original moisture barrier properties of the package, devices are stored and shipped in moisture proof bags filled with dry air. The bags should not be opened or damaged prior to the actual use of the devices. If this is unavoidable, the devices should be stored in a low relative humidity environment (40 to 65%) or in an enclosed environment with desiccant.

TYPICAL APPLICATIONS

CONTROL FUNCTION UTILIZED

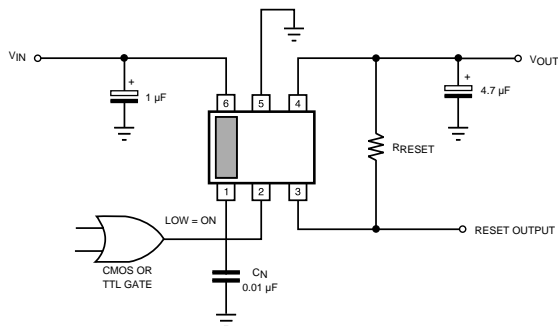

CONTROL FUNCTION NOT UTILIZED

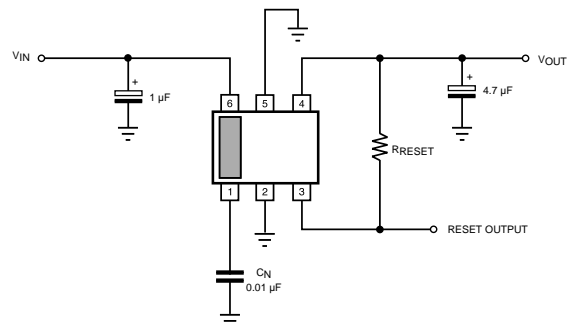

LOW VOLTAGE SHUTDOWN

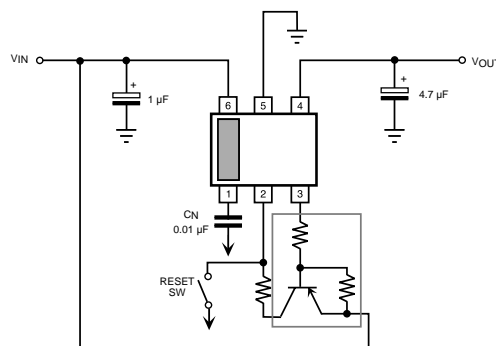

Note: Parallel connection of control pins is allowed if all devices use identical input voltages.

$39\text{ K} \leq R_{RESET} \leq 220\text{ K}$
Choose for correct High Logic level.

PACKAGE OUTLINE

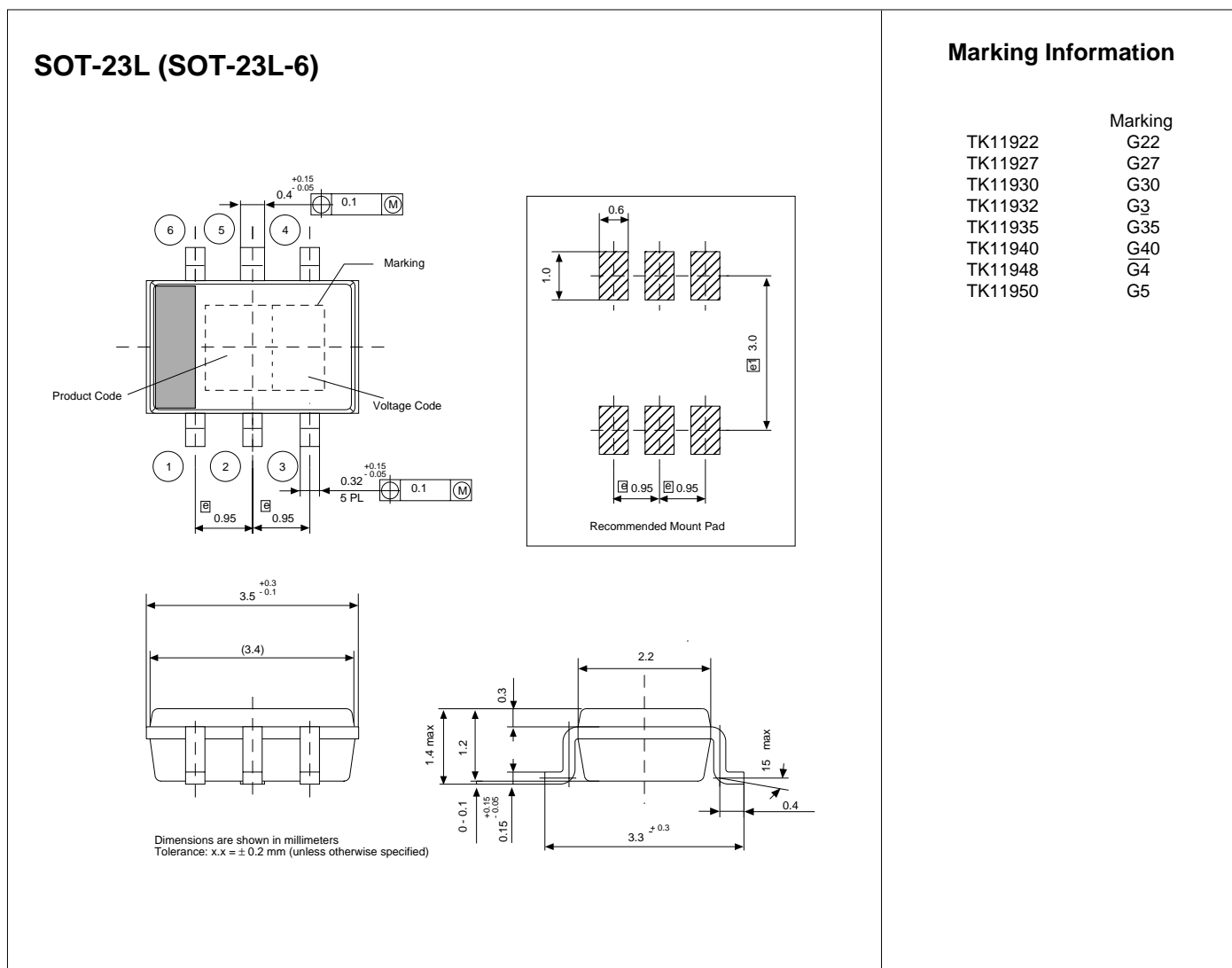

Toko America, Inc. Headquarters
1250 Feehanville Drive, Mount Prospect, Illinois 60056
Tel: (847) 297-0070 Fax: (847) 699-7864

TOKO AMERICA REGIONAL OFFICES

Midwest Regional Office
Toko America, Inc.
1250 Feehanville Drive
Mount Prospect, IL 60056
Tel: (847) 297-0070
Fax: (847) 699-7864

Western Regional Office
Toko America, Inc.
2480 North First Street, Suite 260
San Jose, CA 95131
Tel: (408) 432-8281
Fax: (408) 943-9790

Eastern Regional Office
Toko America, Inc.
107 Mill Plain Road
Danbury, CT 06811
Tel: (203) 748-6871
Fax: (203) 797-1223

Semiconductor Technical Support
Toko Design Center
4755 Forge Road
Colorado Springs, CO 80907
Tel: (719) 528-2200
Fax: (719) 528-2375

Visit our Internet site at <http://www.tokoam.com>

The information furnished by TOKO, Inc. is believed to be accurate and reliable. However, TOKO reserves the right to make changes or improvements in the design, specification or manufacture of its products without further notice. TOKO does not assume any liability arising from the application or use of any product or circuit described herein, nor for any infringements of patents or other rights of third parties which may result from the use of its products. No license is granted by implication or otherwise under any patent or patent rights of TOKO, Inc.