

VOLTAGE REGULATOR WITH ON/OFF SWITCH

FEATURES

- High Voltage Precision at $\pm 2.0\%$
- Active Low On/Off Control
- Very Low Dropout Voltage 80 mV at 30 mA
- Very Low Noise
- Very Small SOT23L or SOT89 Surface Mount Packages
- Internal Thermal Shutdown
- Short Circuit Protection

DESCRIPTION

The TK113xxB is a low dropout linear regulator with a built-in electronic switch. The device is in the "on" state when the control pin is pulled to a low level. An external capacitor can be connected to the noise bypass pin to lower the output noise level to 30 μ Vrms.

An internal PNP pass transistor is used to achieve a low dropout voltage of 80 mV (typ.) at 30 mA load current. The TK113xxB has a very low quiescent current of 170 μ A at no load and 1 mA with a 30 mA load. The standby current is typically 100 nA. The internal thermal shut down circuitry limits the junction temperature to below 150 °C. The load current is internally monitored and the device will shut down in the presence of a short circuit or overcurrent condition at the output.

APPLICATIONS

- Battery Powered Systems
- Cellular Telephones
- Pagers
- Personal Communications Equipment
- Portable Instrumentation
- Portable Consumer Equipment
- Radio Control Systems
- Toys
- Low Voltage Systems

The TK113xxB is available in either 6-pin SOT23L or 5-pin SOT89 surface mount packages.

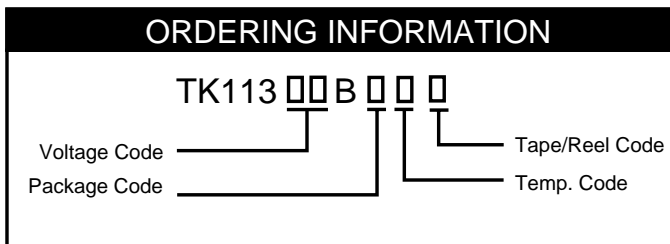
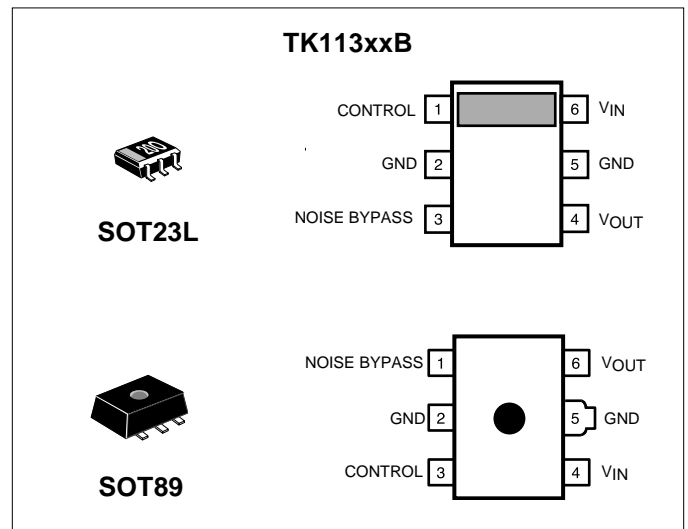

VOLTAGE CODE		PACKAGE CODE:	TAPE/REEL CODE
20 = 2.0 V	37 = 3.7 V	M: SOT23L	L: Tape Left (SOT23L)
21 = 2.1 V	38 = 3.8 V	U: SOT89	B: Tape Left (SOT89)
22 = 2.2 V	39 = 3.9 V		
23 = 2.3 V	40 = 4.0 V		
24 = 2.4 V	41 = 4.1 V		
25 = 2.5 V	42 = 4.2 V		
26 = 2.6 V	43 = 4.3 V		
27 = 2.7 V	44 = 4.4 V		
28 = 2.8 V	45 = 4.5 V		
29 = 2.9 V	46 = 4.6 V		
30 = 3.0 V	47 = 4.7 V		
31 = 3.1 V	48 = 4.8 V		
32 = 3.2 V	49 = 4.9 V		
33 = 3.3 V	50 = 5.0 V		
34 = 3.4 V	55 = 5.5 V		
35 = 3.5 V	60 = 6.0 V		
36 = 3.6 V	80 = 8.0 V		

TEMP. CODE:	
C: -30 to +80 °C	
I: -40 to +85 °C	

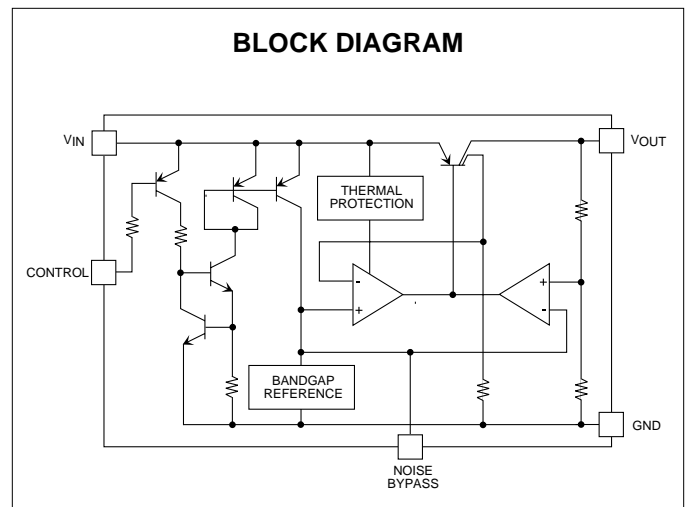

TK113xxBM/U

ABSOLUTE MAXIMUM RATINGS ($V_{OUT} \geq 2.0$ V)

Supply Voltage	16 V	Storage Temperature Range	-55 to +150 °C
Output Current	260 mA	Operating Temperature Range	-30 to +80 °C
Power Dissipation SOT-23L (Note 1)	600 mW	Voltage Range	1.8 to 14.5 V
Power Dissipation SOT-23L (Note 1)	900 mW	Operating Junction Temperature	150 °C
Reverse Bias	10 V		

TK113xxBM/UC ELECTRICAL CHARACTERISTICS ($V_{OUT} \geq 2.0$ V)

Test conditions: $T_A = 25$ °C, unless otherwise specified.

SYMBOL	PARAMETER	TEST CONDITIONS	MIN	TYP	MAX	UNITS
I_Q	Quiescent Current	$I_{OUT} = 0$ mA, Excluding I_{CONT}		170	250	μ A
I_{STBY}	Standby Current	$V_{IN} = 8$ V, Output OFF			0.1	μ A
V_{OUT}	Output Voltage	$I_{OUT} = 30$ mA	See Table 1			V
Line Reg	Line Regulation	$V_{OUT} \leq 5.5$ V, (Note 2)		3.0	20	mV
		$V_{OUT} \geq 5.6$ V, (Note 2)		15	40	mV
Load Reg	Load Regulation	$I_{OUT} = 1$ to 60 mA, (Note 2)		6	30	mV
		$I_{OUT} = 1$ to 100 mA, (Note 2)		18	60	mV
		$I_{OUT} = 1$ to 150 mA, (Note 2)		23	90	mV
V_{DROP}	Dropout Voltage	$I_{OUT} = 60$ mA, (Note 2)		0.12	0.20	V
		$I_{OUT} = 150$ mA, (Note 2)		0.26	0.39	V
I_{OUT}	Continuous Output Current	(Note 2)			150	mA
$I_{OUT(PULSE)}$	Pulse Output Current	5 ms pulse, 12.5 % duty cycle			180	mA
RR	Ripple Rejection	$f = 400$ Hz, $C_L = 10$ μ F, $C_N = 0.1$ μ F, $V_{IN} = V_{OUT} + 1.5$ V, $I_{OUT} = 30$ mA, $V_{RIPPLE} = 100$ mVrms, (Note 3)		60		dB
V_{NO}	Output Noise Voltage	10 Hz $\leq f \leq 80$ kHz, $C_L = 10$ μ F, $C_N = 0.1$ μ F, $V_{CN} = V_{OUT} + 1.5$ V, $I_{OUT} = 60$ mA, (Notes 3,4)		30		μ Vrms
V_{ref}	Noise Bypass Terminal Voltage			1.25		V
$\Delta V_{OUT} / \Delta T$	Temperature Coefficient	$I_{OUT} = 10$ mA		40		ppm/° C

CONTROL TERMINAL SPECIFICATIONS

I_{CONT}	Control Current	$V_{CONT} = 1.8$ V, Output ON		12	35	μ A
$V_{CONT(ON)}$	Control Voltage ON	Output ON			$V_{CC} - 1.8$	V
$V_{CONT(OFF)}$	Control Voltage OFF	Output OFF	$V_{CC} - 0.6$			V

Note 1: When mounted as recommended. Derate at 4.8 mW/°C for SOT-23L and 6.4 mW/°C for SOT-89 packages for operation above 25°C.

Note 2: Refer to "Definition of Terms."

Note 3: Ripple rejection and noise voltage are affected by the value and characteristics of the capacitor used.

Note 4: Output noise voltage can be reduced by connecting a capacitor to a noise pass terminal.

Gen. Note: Parameters with min. or max. values are 100% tested at $T_A = 25$ °C.

ABSOLUTE MAXIMUM RATINGS TK113xxBI ($V_{OUT} \geq 2.5 V$)

Supply Voltage	16 V	Storage Temperature Range	-55 to +150 °C
Power Dissipation SOT-23L (Note1)	600 mW	Operating Temperature Range	-40 to +85 °C
Power Dissipation SOT-89 (Note1)	900 mW	Operating Voltage Range	1.8 to 14.5 V
Reverse Bias	10 V	Junction Temperature	150 °C

TK113xxBM/UI ELECTRICAL CHARACTERISTICS ($V_{OUT} \geq 2.5 V$)

Test conditions: $T_A = -40$ to 85 °C, unless otherwise specified.

SYMBOL	PARAMETER	TEST CONDITIONS	MIN	TYP	MAX	UNITS
I_Q	Quiescent Current	$I_{OUT} = 0$ mA, Excluding I_{CONT}		170	300	μ A
I_{STBY}	Standby Current	$V_{IN} = 8$ V, Output OFF			0.2	μ A
V_{OUT}	Output Voltage	$I_{OUT} = 30$ mA	See Table 2			V
Line Reg	Line Regulation	$V_{OUT} \leq 5.5$ V,(Note 2)		3.0	25	mV
		$V_{OUT} = 5.6$ V,(Note 2)		15	40	mV
Load Reg	Load Regulation	$I_{OUT} = 1$ to 60 mA, (Note 2)		6	40	mV
		$I_{OUT} = 1$ to 100 mA, (Note 2)		18	80	mV
		$I_{OUT} = 1$ to 150 mA, (Note 2)		23	110	mV
V_{DROP}	Dropout Voltage	$I_{OUT} = 60$ mA, (Note 2)		0.12	0.23	V
		$I_{OUT} = 150$ mA, (Note 2)		0.26	0.40	V
I_{OUT}	Continuous Output Current	(Note 2)			150	mA
$I_{OUT(PULSE)}$	Pulse Output Current	5 ms pulse, 12.5 % duty cycle			180	mA
RR	Ripple Rejection	$f = 400$ Hz, $C_L = 10$ μ F, $C_N = 0.1$ μ F, $V_{IN} = V_{OUT} + 1.5$ V, $I_{OUT} = 30$ mA, $V_{RIPPLE} = 100$ mVrms, (Note 3)		60		dB
V_{NO}	Output Noise Voltage	10 Hz $\leq f \leq 80$ kHz, $C_L = 10$ μ F, $C_N = 0.1$ μ F, $V_{CN} = V_{OUT} + 1.5$ V, $I_{OUT} = 60$ mA, (Notes 3,4)		30		μ Vrms
V_{ref}	Noise Bypass Terminal Voltage			1.25		V
$\Delta V_{OUT} / \Delta T$	Temperature Coefficient	$I_{OUT} = 10$ mA		40		ppm/° C

CONTROL TERMINAL SPECIFICATIONS

I_{CONT}	Control Current	$V_{CONT} = 1.8$ V, Output ON		12	40	μ A
$V_{CONT(ON)}$	Control Voltage ON	Output ON			$V_{CC} - 2.0$	V
$V_{CONT(OFF)}$	Control Voltage OFF	Output OFF	$V_{CC} - 0.5$			V

Note 1: When mounted as recommended. Derate at 4.8 mW/°C for SOT-23L and 6.4 mW/°C for SOT-89 packages for operation above 25 °C.

Note 2: Refer to "Definition of Terms."

Note 3: Ripple rejection and noise voltage are affected by the value and characteristics of the capacitor used.

Note 4: Output noise voltage can be reduced by connecting a capacitor to a noise pass terminal.

Gen Note: Parameters with min. or max. values are 100% tested at $T_A = 25$ °C.

Gen Note: For Line Regulation, typ. and max. is changed to $V_{OUT} > 5.6$ V.

TK113xxBM/U

TK113xxBM/UC ELECTRICAL CHARACTERISTICS TABLE 1

Test conditions: $T_A = 25\text{ }^\circ\text{C}$, $I_{OUT} = 30\text{ mA}$, unless otherwise specified.

Output Voltage	Voltage Code	$V_{OUT(MIN)}$	$V_{OUT(MAX)}$	Test Voltage
2.0 V	20	1.940 V	2.060 V	3.0 V
2.1 V	21	2.040 V	2.160 V	3.1 V
2.2 V	22	2.140 V	2.260 V	3.2 V
2.3 V	23	2.240 V	2.360 V	3.3 V
2.4 V	24	2.340 V	2.460 V	3.4 V
2.5 V	25	2.440 V	2.560 V	3.5 V
2.6 V	26	2.540 V	2.660 V	3.6 V
2.7 V	27	2.640 V	2.760 V	3.7 V
2.8 V	28	2.740 V	2.860 V	3.8 V
2.9 V	29	2.840 V	2.960 V	3.9 V
3.0 V	30	2.940 V	3.060 V	4.0 V
3.1 V	31	3.040 V	3.160 V	4.1 V
3.2 V	32	3.140 V	3.260 V	4.2 V
3.3 V	33	3.240 V	3.360 V	4.3 V
3.4 V	34	3.335 V	3.465 V	4.4 V
3.5 V	35	3.435 V	3.565 V	4.5 V
3.6 V	36	3.535 V	3.665 V	4.6 V

Output Voltage	Voltage Code	$V_{OUT(MIN)}$	$V_{OUT(MAX)}$	Test Voltage
3.7 V	37	3.630 V	3.770 V	4.7 V
3.8 V	38	3.725 V	3.875 V	4.8 V
3.9 V	39	3.825 V	3.975 V	4.9 V
4.0 V	40	3.920 V	4.080 V	5.0 V
4.1 V	41	4.020 V	4.180 V	5.1 V
4.2 V	42	4.120 V	4.280 V	5.2 V
4.3 V	43	4.215 V	4.385 V	5.3 V
4.4 V	44	4.315 V	4.485 V	5.4 V
4.5 V	45	4.410 V	4.590 V	5.5 V
4.6 V	46	4.510 V	4.690 V	5.6 V
4.7 V	47	4.605 V	4.795 V	5.7 V
4.8 V	48	4.705 V	4.895 V	5.8 V
4.9 V	49	4.800 V	5.000 V	5.9 V
5.0 V	50	4.900 V	5.100 V	6.0 V
5.5 V	55	5.390 V	5.610 V	6.5 V
6.0 V	60	5.880 V	6.120 V	7.0 V
8.0 V	80	7.840 V	8.160 V	9.0 V

TK113xxBM/UI ELECTRICAL CHARACTERISTICS TABLE 2Test Conditions: $V_{IN} = V_{OUT(TYP)} + 1\text{ V}$, $I_{OUT} = 30\text{ mA}$, unless otherwise specified.

Output Voltage	Voltage Code	Room Temp. Range ($T_A = 25\text{ }^\circ\text{C}$)		Full Temp. Range ($T_A = -40\text{ to }+85\text{ }^\circ\text{C}$)	
		$V_{OUT(MIN)}$	$V_{OUT(MAX)}$	$V_{OUT(MIN)}$	$V_{OUT(MAX)}$
2.5 V	25	2.440 V	2.560 V	2.400 V	2.600 V
2.6 V	26	2.540 V	2.660 V	2.500 V	2.700 V
2.7 V	27	2.640 V	2.760 V	2.600 V	2.800 V
2.8 V	28	2.750 V	2.860 V	2.700 V	2.900 V
2.9 V	29	2.840 V	2.960 V	2.800 V	3.000 V
3.0 V	30	2.940 V	3.060 V	2.900 V	3.100 V
3.1 V	31	3.040 V	3.160 V	3.000 V	3.200 V
3.2 V	32	3.140 V	3.260 V	3.095 V	3.305 V
3.3 V	33	3.240 V	3.360 V	3.190 V	3.410 V
3.4 V	34	3.335 V	3.465 V	3.290 V	3.510 V
3.5 V	35	3.435 V	3.565 V	3.385 V	3.615 V
3.6 V	36	3.535 V	3.665 V	3.485 V	3.720 V
3.7 V	37	3.630 V	3.770 V	3.580 V	3.820 V
3.8 V	38	3.725 V	3.875 V	3.675 V	3.925 V
3.9 V	39	3.825 V	3.975 V	3.770 V	4.030 V
4.0 V	40	3.920 V	4.080 V	3.870 V	4.130 V
4.1 V	41	4.020 V	4.180 V	3.965 V	4.235 V
4.2 V	42	4.120 V	4.280 V	4.060 V	4.335 V
4.3 V	43	4.215 V	4.385 V	4.160 V	4.440 V
4.4 V	44	4.315 V	4.485 V	4.255 V	4.545 V
4.5 V	45	4.410 V	4.590 V	4.350 V	4.645 V
4.6 V	46	4.510 V	4.690 V	4.450 V	4.750 V
4.7 V	47	4.605 V	4.795 V	4.545 V	4.850 V
4.8 V	48	4.705 V	4.895 V	4.640 V	4.955 V
4.9 V	49	4.800 V	5.000 V	4.740 V	5.060 V
5.0 V	50	4.900 V	5.100 V	4.835 V	5.165 V
5.5 V	55	5.390 V	5.610 V	5.320 V	5.680 V
6.0 V	60	5.880 V	6.120 V	5.805 V	6.195 V
8.0 V	80	7.840 V	8.160 V	7.745 V	8.265 V

TEST CIRCUITS

SOT23L

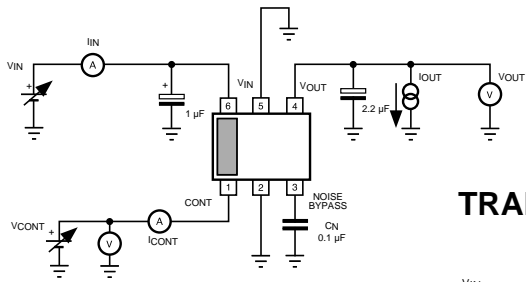

SOT89

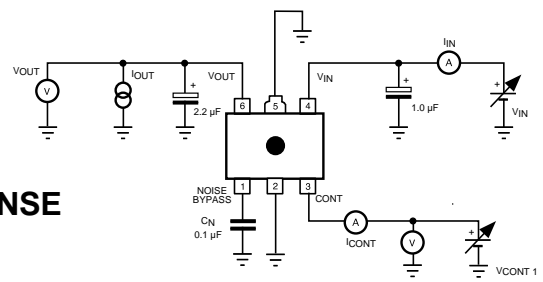

TRANSIENT RESPONSE

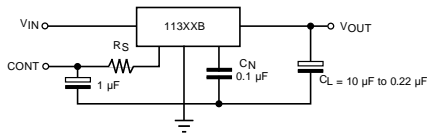

Note: Connect pin 5 to ground for heat sink

TYPICAL PERFORMANCE CHARACTERISTICS

$T_A = 25^\circ\text{C}$, unless otherwise specified.

OUTPUT VOLTAGE RESPONSE (OFF→ON)

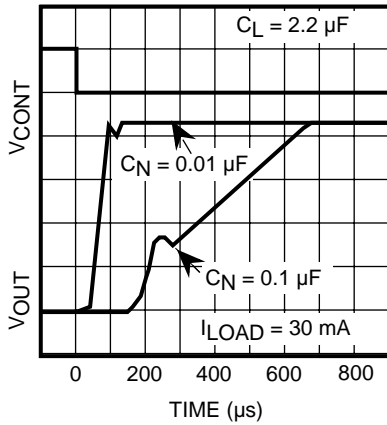

LOAD REGULATION

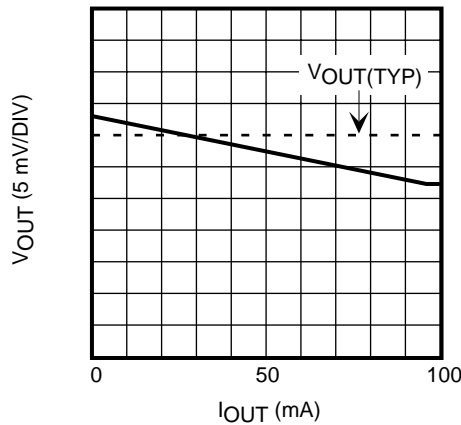

SHORT CIRCUIT CURRENT

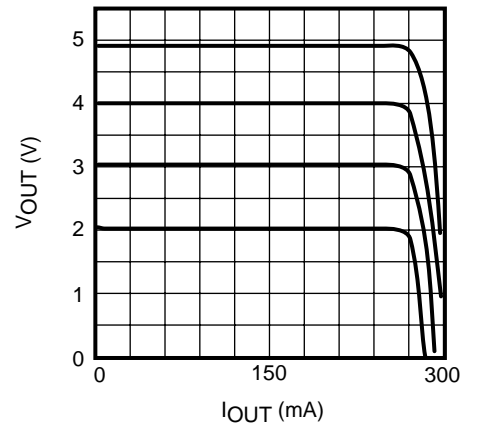

OUTPUT VOLTAGE vs. INPUT VOLTAGE

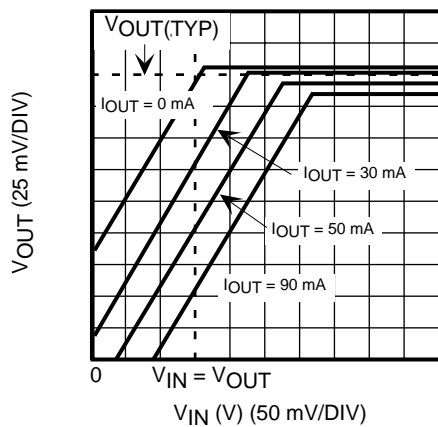

LINE REGULATION

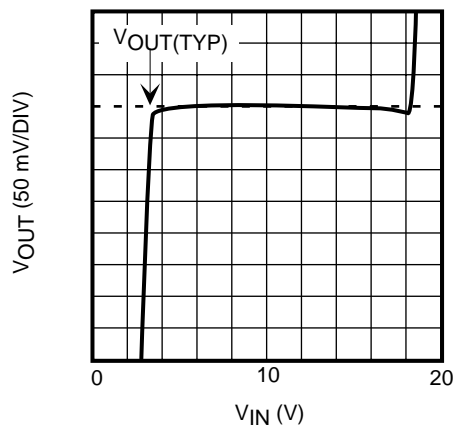

DROPOUT VOLTAGE vs. OUTPUT CURRENT

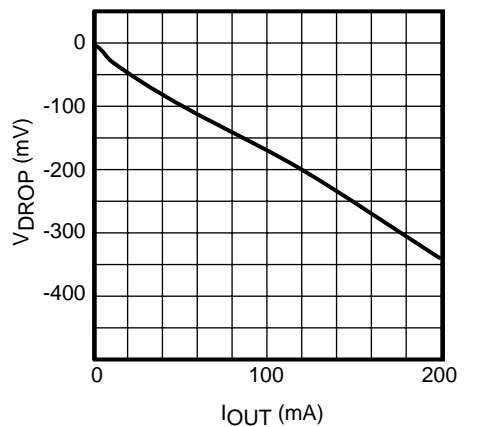

TYPICAL PERFORMANCE CHARACTERISTICS (CONT.)

$T_A = 25\text{ }^\circ\text{C}$, unless otherwise specified.

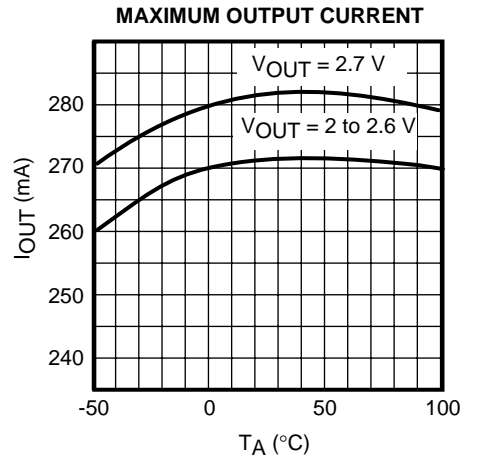
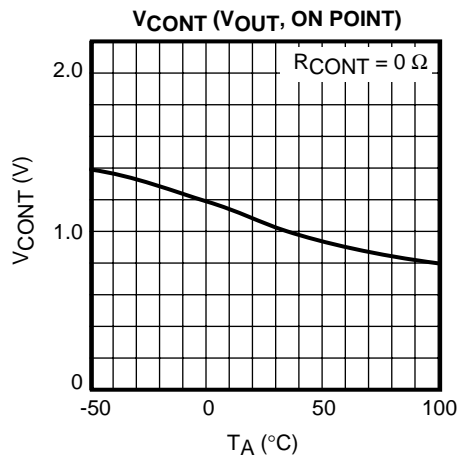
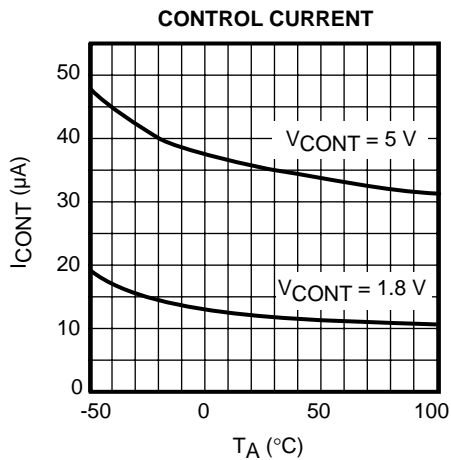
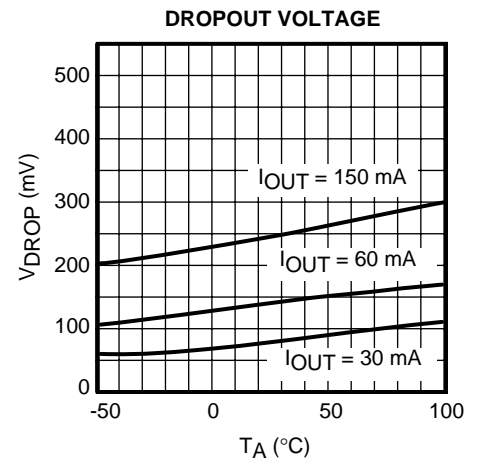
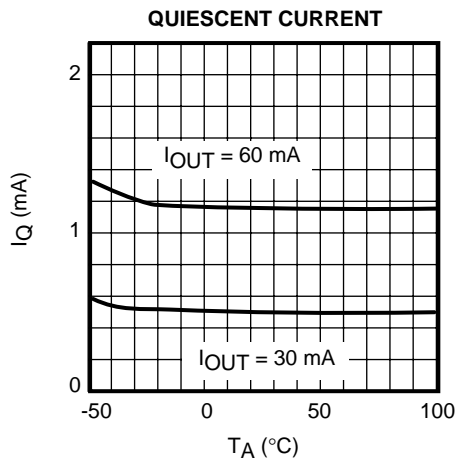
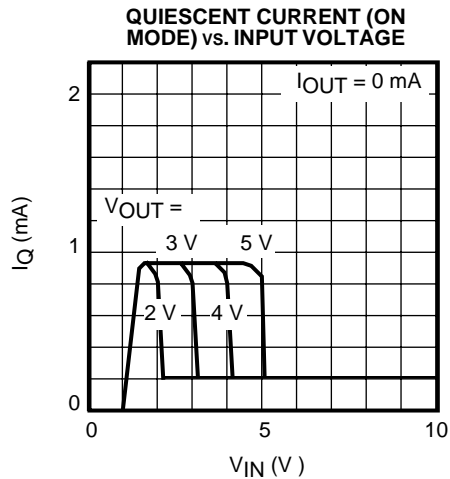
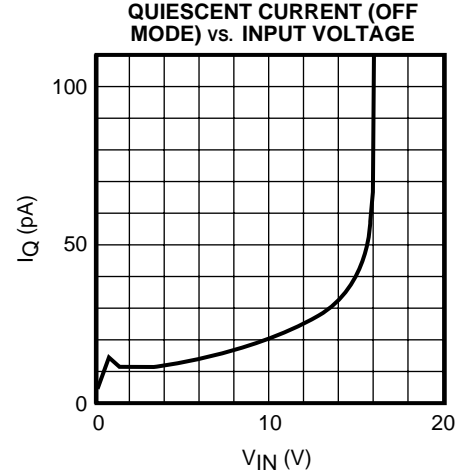
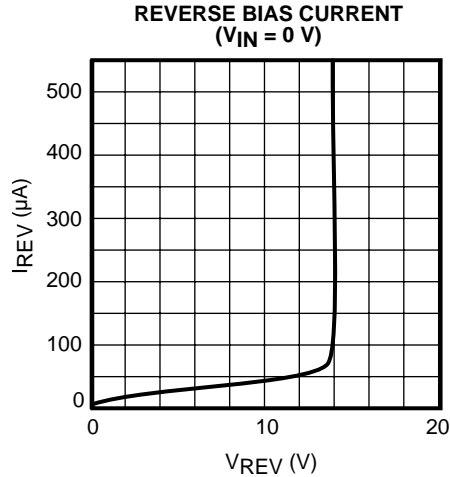
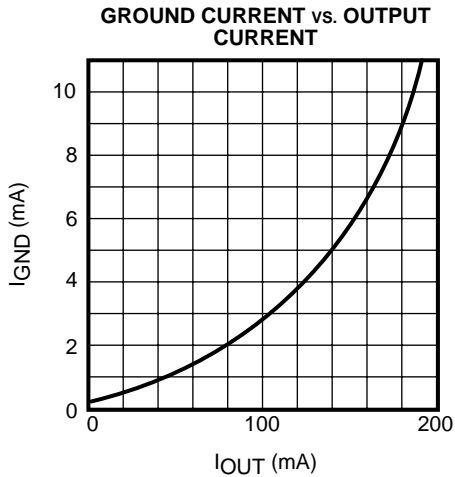

TYPICAL PERFORMANCE CHARACTERISTICS (CONT.)

$T_A = 25\text{ }^\circ\text{C}$, unless otherwise specified.

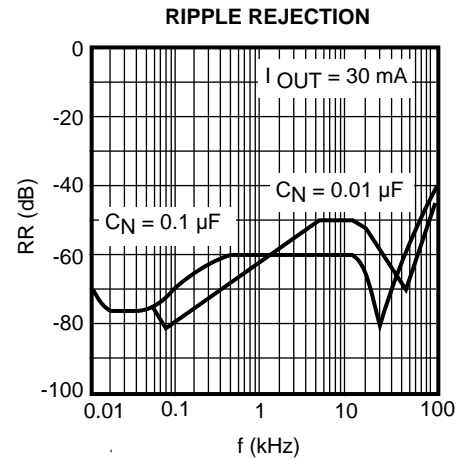
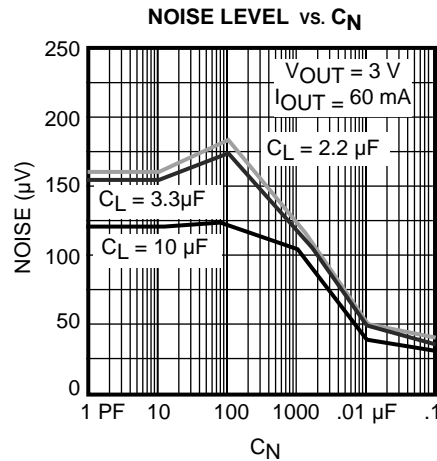
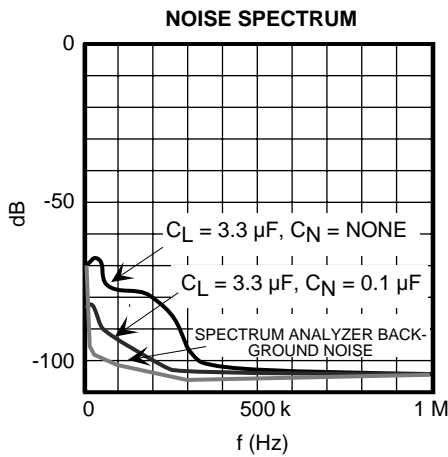
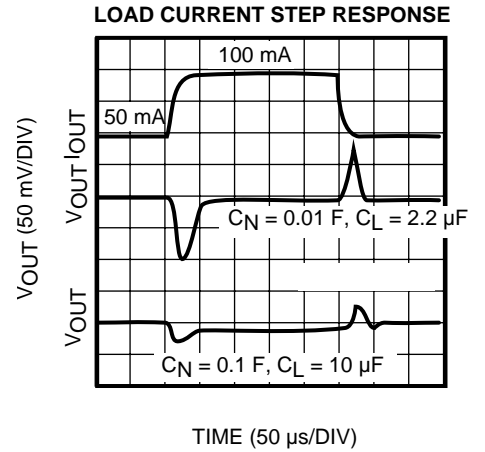
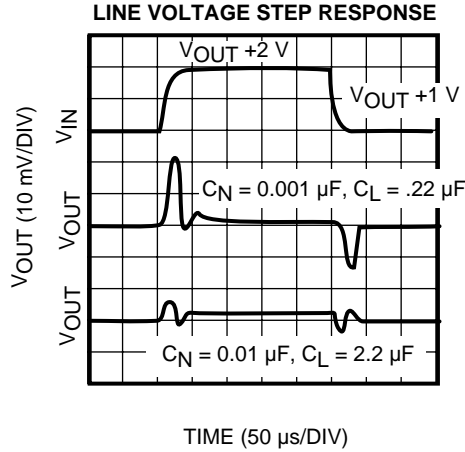
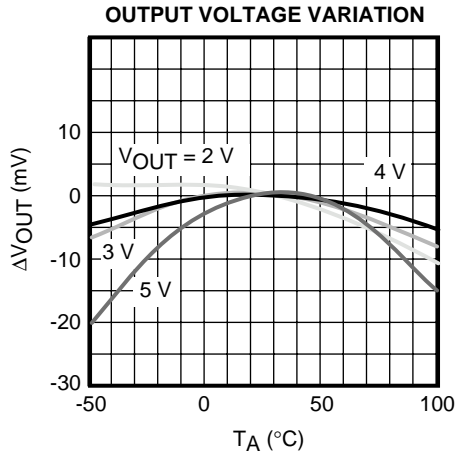

DEFINITION AND EXPLANATION OF TECHNICAL TERMS

OUTPUT VOLTAGE (V_{OUT})

The output voltage is specified with $V_{IN} = (V_{OUT(TYP)} + 1 \text{ V})$ and $I_{OUT} = 30 \text{ mA}$.

DROPOUT VOLTAGE (V_{DROP})

The dropout voltage is the difference between the input voltage and the output voltage at which point the regulator starts to fall out of regulation. Below this value, the output voltage will fall as the input voltage is reduced. It is dependent upon the load current and the junction temperature.

OUTPUT CURRENT ($I_{OUT(MAX)}$)

This is the maximum continuous output current as specified under the condition where the output voltage drops 0.3 V below the value specified with $I_{OUT} = 30 \text{ mA}$. The input voltage is set to $V_{OUT} + 1 \text{ V}$, and the current is pulsed to minimize temperature effect.

CONTINUOUS OUTPUT CURRENT (I_{OUT})

Normal operating output current. This is limited by package power dissipation.

PULSE OUTPUT CURRENT ($I_{OUT(PULSE)}$)

Max pulse width 5 ms, Duty cycle 12.5%: pulse load only.

LINE REGULATION (Line Reg)

Line regulation is the ability of the regulator to maintain a constant output voltage as the input voltage changes. The line regulation is specified as the input voltage is changed from $V_{IN} = V_{OUT(TYP)} + 1 \text{ V}$ to $V_{IN} = V_{OUT(TYP)} + 6 \text{ V}$.

LOAD REGULATION (Load Reg)

Load regulation is the ability of the regulator to maintain a constant output voltage as the load current changes. It is a pulsed measurement to minimize temperature effects with the input voltage set to $V_{IN} = V_{OUT} + 1 \text{ V}$. The load regulation is specified under two output current step conditions of 1 mA to 60 mA and 1 mA to 100 mA.

QUIESCENT CURRENT (I_Q)

The quiescent current is the current which flows through the ground terminal under no load conditions ($I_{OUT} = 0 \text{ mA}$).

GROUND CURRENT (I_{GND})

Ground current is the current which flows through the ground pin(s). It is defined as $I_{IN} - I_{OUT}$, excluding control current.

RIPPLE REJECTION RATIO (RR)

Ripple rejection is the ability of the regulator to attenuate the ripple content of the input voltage at the output. It is specified with 100 mVrms, 400 Hz superimposed on the input voltage, where $V_{IN} = V_{OUT} + 1.5 \text{ V}$. The output decoupling capacitor is set to 10 μF , the noise bypass capacitor is set to 0.1 μF , and the load current is set to 30 mA. Ripple rejection is the ratio of the ripple content of the output vs. the input and is expressed in dB.

STANDBY CURRENT (I_{STBY})

Standby current is the current which flows into the regulator when the output is turned off by the control function ($V_{CONT} = V_{IN}$). It is measured with $V_{IN} = 8 \text{ V}$ (9 V for the 8 V output device).

SENSOR CIRCUITS

Overcurrent Sensor

The overcurrent sensor protects the device in the event that the output is shorted to ground.

Thermal Sensor

The thermal sensor protects the device in the event that the junction temperature exceeds the safe value ($T_J = 150 \text{ }^\circ\text{C}$). This temperature rise can be caused by external heat, excessive power dissipation caused by large input to output voltage drops, or excessive output current. The regulator will shut off when the temperature exceeds the safe value. As the junction temperatures decrease, the regulator will begin to operate again. Under sustained fault conditions, the regulator output will oscillate as the device turns off then resets. Damage may occur to the device under extreme fault conditions.

DEFINITION AND EXPLANATION OF TECHNICAL TERMS (CONT.)

Reverse Voltage Protection

Reverse voltage protection prevents damage due to the output voltage being higher than the input voltage. This fault condition can occur when the output capacitor remains charged and the input is reduced to zero, or when an external voltage higher than the input voltage is applied to the output side.

If the control function is not used, connect the control terminal to V_{IN} . When the control function is used, the control current can be reduced by inserting a series resistor (R_{CONT}) between the control terminal and V_{IN} . The value of this resistor should be determined from the graph below.

CONTROL CURRENT

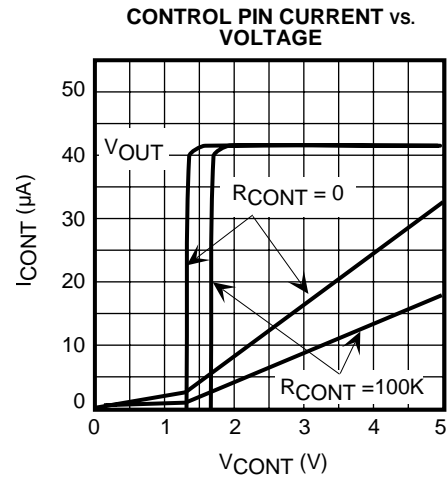
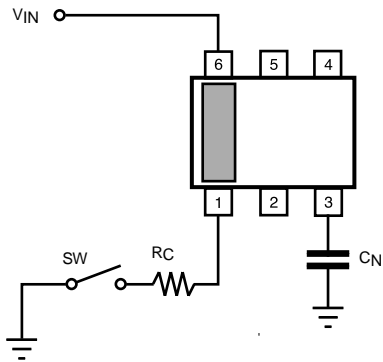

Note: V_{CONT} = differential voltage from V_{IN} pin to V_{CONT} pin.

SOT23L

The requirement for the pullup resistor (R_{PULLUP}) is determined by the external control circuitry. For example, open collector/open drain logic may require R_{PULLUP} over temperature; CMOS logic will not require R_{PULLUP} .

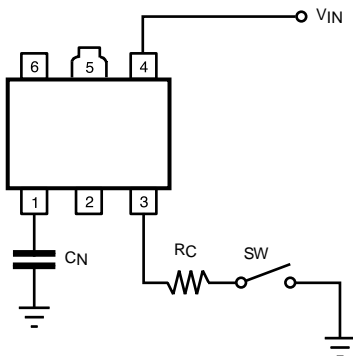

SOT89

DEFINITION AND EXPLANATION OF TECHNICAL TERMS (CONT.)

ON/OFF RESPONSE WITH CONTROL AND LOAD TRANSIENT RESPONSE

The turn-on time depends upon the value of the output capacitor and the noise bypass capacitor. The turn-on time will increase with the value of either capacitor. The graphs below show the relationship between turn-on time and load capacitance. If the value of these capacitors is reduced, the load and line regulation will suffer and the noise voltage will increase. If the value of these capacitors is increased, the turn-on time will increase.

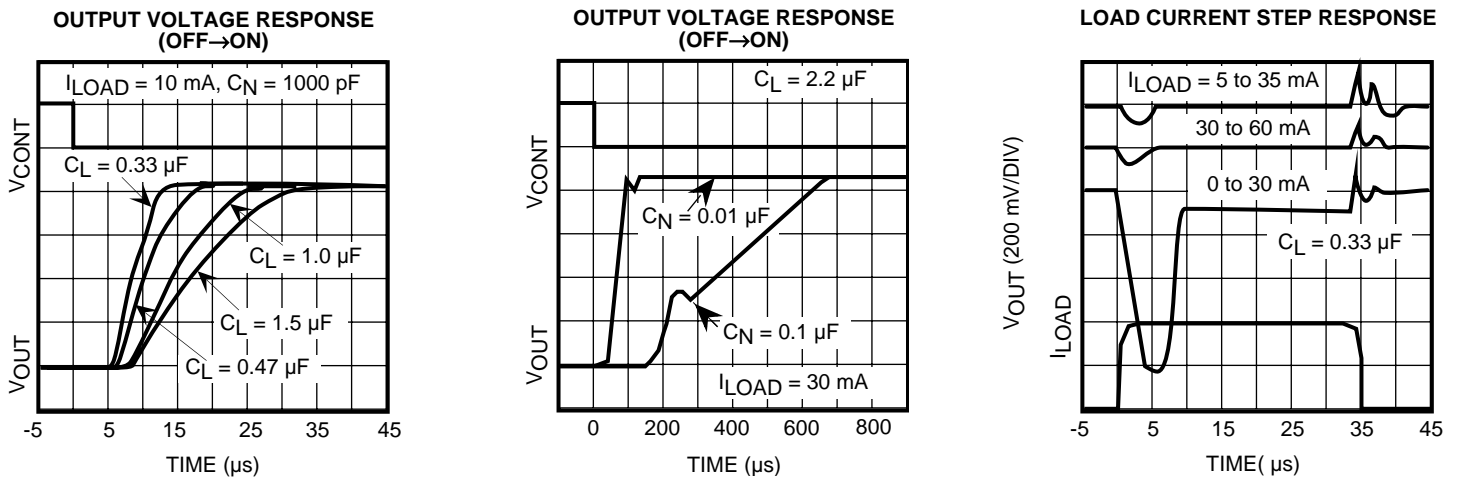

REDUCTION OF OUTPUT NOISE

Although the architecture of the Toko regulators is designed to minimize semiconductor noise, further reduction can be achieved by the selection of external components. The obvious solution is to increase the size of the output capacitor. A more effective solution would be to add a capacitor to the noise bypass terminal. The value of this capacitor should be $0.1\text{ }\mu\text{F}$ or higher (higher values provide greater noise reduction). Although stable operation is possible without the noise bypass capacitor, this terminal has a high impedance and care should be taken to avoid a large circuit area on the printed circuit board when the capacitor is not used. Please note that several parameters are affected by the value of the capacitors and bench testing is recommended when deviating from standard values.

DEFINITION AND EXPLANATION OF TECHNICAL TERMS (CONT.)

PACKAGE POWER DISSIPATION (P_D)

This is the power dissipation level at which the thermal sensor is activated. The IC contains an internal thermal sensor which monitors the junction temperature. When the junction temperature exceeds the monitor threshold of 150 °C, the IC is shut down. The junction temperature rises as the difference between the input power ($V_{IN} \times I_{IN}$) and the output power ($V_{OUT} \times I_{OUT}$) increases. The rate of temperature rise is greatly affected by the mounting pad configuration on the PCB, the board material, and the ambient temperature. When the IC mounting has good thermal conductivity, the junction temperature will be low even if the power dissipation is great. When mounted on the recommended mounting pad, the power dissipation of the SOT-23L is increased to 600 mW. For operation at ambient temperatures over 25 °C, the power dissipation of the SOT-23L device should be derated at 4.8 mW/°C. The power dissipation of the SOT-89 package is 900 mW when mounted as recommended. Derate the power dissipation at 7.2 mW/°C for operation above 25 °C. To determine the power dissipation for shutdown when mounted, attach the device on the actual PCB and deliberately increase the output current (or raise the input voltage) until the thermal protection circuit is activated. Calculate the power dissipation of the device by subtracting the output power from the input power. These measurements should allow for the ambient temperature of the PCB. The value obtained from $P_D / (150\text{ °C} - T_A)$ is the derating factor. The PCB mounting pad should provide maximum thermal conductivity in order to maintain low device temperatures. As a general rule, the lower the temperature, the better the reliability of the device. The thermal resistance when mounted is expressed as follows:

$$T_j = \theta_{jA} \times P_D + T_A$$

For Toko ICs, the internal limit for junction temperature is 150 °C. If the ambient temperature (T_A) is 25 °C, then:

$$\begin{aligned} 150\text{ °C} &= \theta_{jA} \times P_D + 25\text{ °C} \\ \theta_{jA} \times P_D &= 125\text{ °C} \\ \theta_{jA} &= 125\text{ °C} / P_D \end{aligned}$$

P_D is the value when the thermal sensor is activated. A simple way to determine PD is to calculate $V_{IN} \times I_{IN}$ when

the output side is shorted. Input current gradually falls as temperature rises. You should use the value when thermal equilibrium is reached.

The range of usable currents can also be found from the graph below.

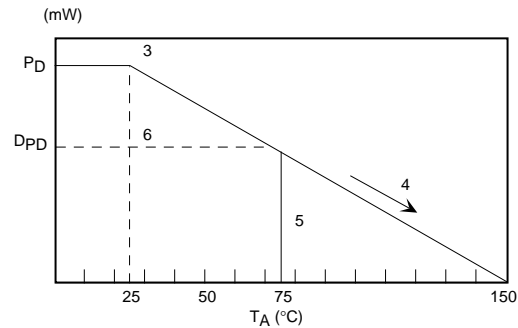

Procedure:

- 1) Find P_D
- 2) P_{D1} is taken to be $P_D \times (\sim 0.8 - 0.9)$
- 3) Plot P_{D1} against 25 °C
- 4) Connect P_{D1} to the point corresponding to the 150 °C with a straight line.
- 5) In design, take a vertical line from the maximum operating temperature (e.g., 75 °C) to the derating curve.
- 6) Read off the value of P_D against the point at which the vertical line intersects the derating curve. This is taken as the maximum power dissipation, D_{PD} .

The maximum operating current is:

$$I_{OUT} = (D_{PD} / (V_{IN(MAX)} - V_{OUT}))$$

DEFINITION AND EXPLANATION OF TECHNICAL TERMS (CONT.)

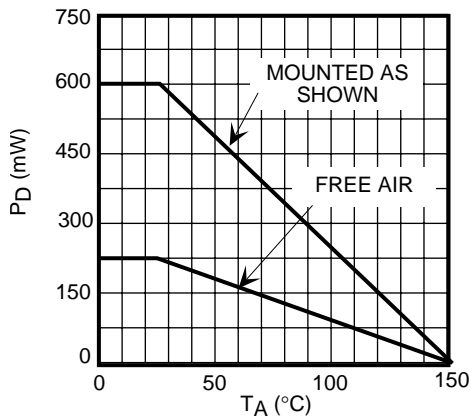

SOT23L POWER DISSIPATION CURVE

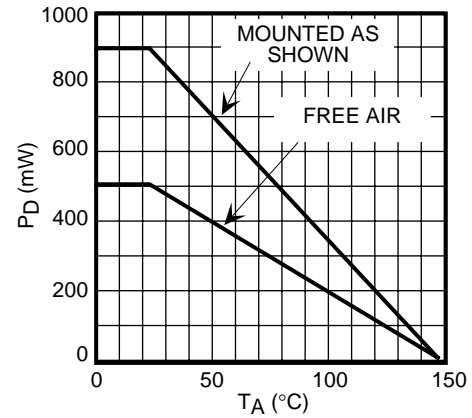

SOT89 POWER DISSIPATION CURVE

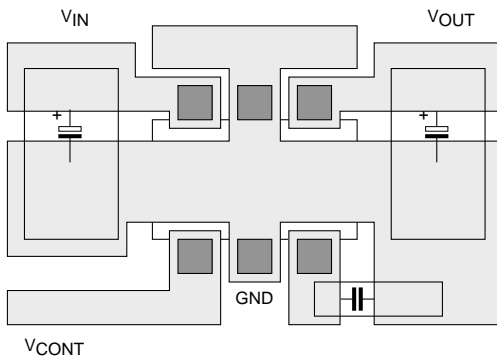

SOT23L BOARD LAYOUT

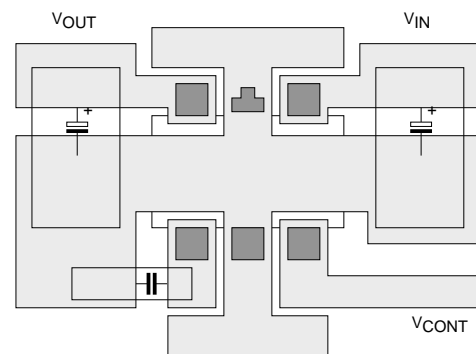

SOT89 BOARD LAYOUT

APPLICATION NOTE

Copper pattern should be as large as possible. Power dissipation is 600 mW for SOT23L and 900 mW for SOT89. A low Equivalent Series Resistance (ESR) capacitor is recommended. For low temperature operation, select a capacitor with a low ESR at the lowest operating temperature to prevent oscillation, degradation of ripple rejection and increase in noise. The minimum recommended capacitance is 2.2 μ F.

APPLICATION INFORMATION

INPUT-OUTPUT CAPACITORS

Linear regulators require an output capacitor in order to maintain regulator loop stability. This capacitor should be selected to ensure stable operation over the desired temperature and load range. The graphs below show the effects of capacitance value and ESR on the stable operation area.

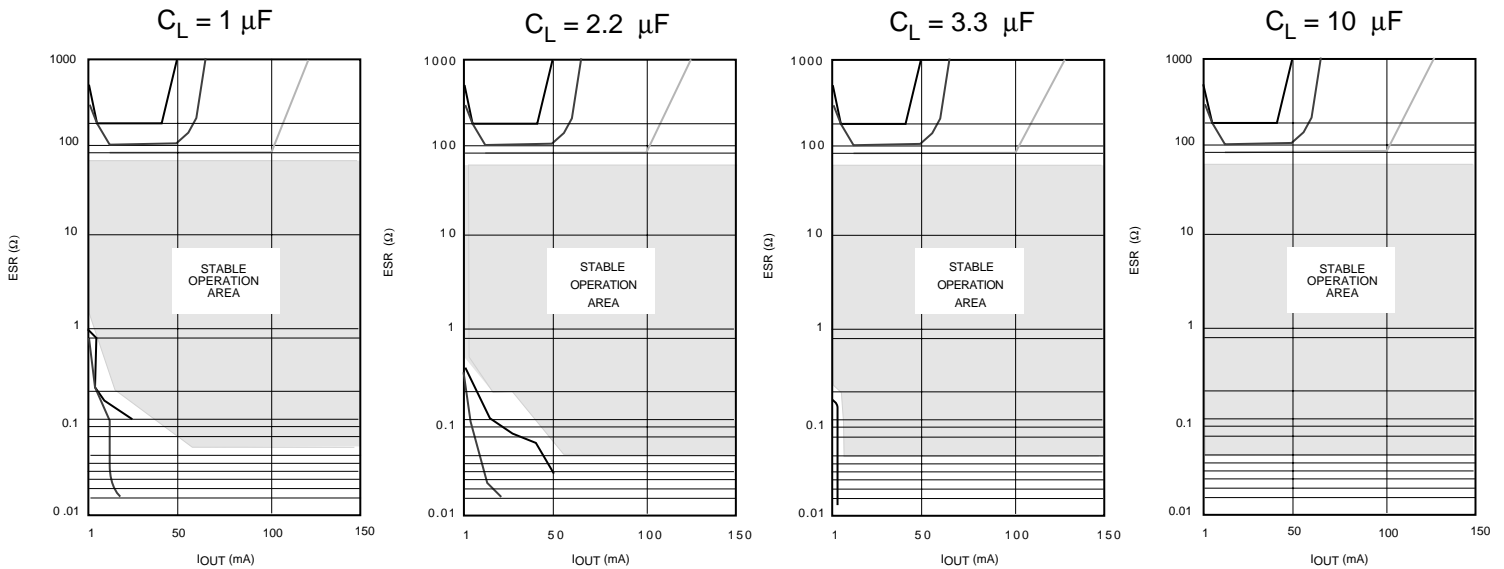
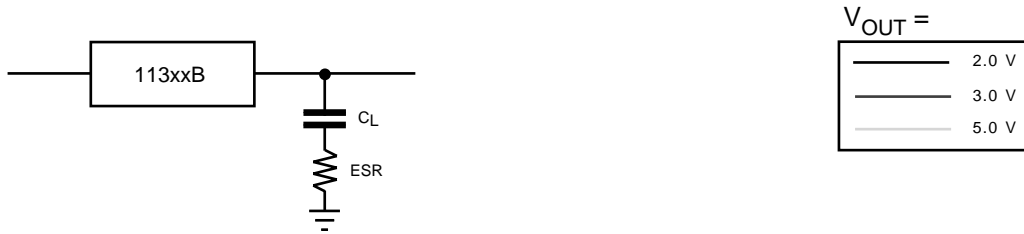

In general, the capacitor should be at least $1 \mu\text{F}$ (aluminum electrolytic) and be rated for the actual ambient operating temperature range. The table below shows typical characteristics for several types and values of capacitance. Please note that the ESR varies widely depending upon manufacturer, type, size, and material.

ESR Capacitance	Aluminum Capacitor	Tantalum Capacitor	Ceramic Capacitor
1.0 μF	2.4 Ω	2.3 Ω	0.140 Ω
2.2 μF	2.0 Ω	1.9 Ω	0.059 Ω
3.3 μF	4.6 Ω	1.0 Ω	0.049 Ω
10 μF	1.4 Ω	0.5 Ω	0.025 Ω

Note: ESR is measured at 10 kHz.

NOTES

PACKAGE OUTLINE

SOT23L-6

Note: Pin 2 and Pin 5 should be grounded for heat dissipation

Dimensions are shown in millimeters
Tolerance: x.x = ± 0.2 mm (unless otherwise specified)

Marking Information

Product Code	Q	Voltage Code
TK11320B	20	
TK11321B	21	
TK11322B	22	
TK11323B	23	
TK11324B	24	
TK11325B	25	
TK11326B	26	
TK11327B	27	
TK11328B	28	
TK11329B	29	
TK11330B	30	
TK11331B	31	
TK11332B	32	
TK11333B	33	
TK11334B	34	
TK11335B	35	
TK11336B	36	
TK11337B	37	
TK11338B	38	
TK11339B	39	
TK11340B	40	
TK11341B	41	
TK11342B	42	
TK11343B	43	
TK11344B	44	
TK11345B	45	
TK11346B	46	
TK11347B	47	
TK11348B	48	
TK11349B	49	
TK11350B	50	
TK11355B	55	
TK11360B	60	
TK11380B	80	

SOT89-5

Dimensions are shown in millimeters
Tolerance: x.x = ± 0.2 mm (unless otherwise specified)



Toko America, Inc. Headquarters
 1250 Feehanville Drive, Mount Prospect, Illinois 60056
 Tel: (847) 297-0070 Fax: (847) 699-7864

TOKO AMERICA REGIONAL OFFICES

Midwest Regional Office
 Toko America, Inc.
 1250 Feehanville Drive
 Mount Prospect, IL 60056
 Tel: (847) 297-0070
 Fax: (847) 699-7864

Western Regional Office
 Toko America, Inc.
 2480 North First Street, Suite 260
 San Jose, CA 95131
 Tel: (408) 432-8281
 Fax: (408) 943-9790

Eastern Regional Office
 Toko America, Inc.
 107 Mill Plain Road
 Danbury, CT 06811
 Tel: (203) 748-6871
 Fax: (203) 797-1223

Semiconductor Technical Support
 Toko Design Center
 4755 Forge Road
 Colorado Springs, CO 80907
 Tel: (719) 528-2200
 Fax: (719) 528-2375

Visit our Internet site at <http://www.tokoam.com>

The information furnished by TOKO, Inc. is believed to be accurate and reliable. However, TOKO reserves the right to make changes or improvements in the design, specification or manufacture of its products without further notice. TOKO does not assume any liability arising from the application or use of any product or circuit described herein, nor for any infringements of patents or other rights of third parties which may result from the use of its products. No license is granted by implication or otherwise under any patent or patent rights of TOKO, Inc.