

## Request For Quotation

Order the parts you need from our real-time inventory database. Simply complete a request for quotation form with your part information and a sales representative will respond to you with price and availability.

[Request For Quotation](#)

**Your free datasheet starts on the next page.**

More datasheets and data books are available from our homepage: <http://www.datasheetarchive.com>

# TOKIN

The World's Most Advanced Passive Components

## EMI/EMC Components - Data Line Filters

NZ Series Solid Chip Noise Suppressors (N1608Z ~ N5750Z)

Multi-layered Chip Impedance Array

Three-Terminal EMI Chip Filters

Chip Varistor

EMI Suppressor Sheets – “Flex Suppressor”

EMC Chip Filters (M-500 Series)

DC Line Filters – SBP Series

SBT Coils

Data Line Filters

Bead Inductors

DIP Noise Filters

SN Coils – SNT Series

EMC Beads

## NZ Series Solid Chip Noise Suppressors (N1608Z ~ N5750Z)

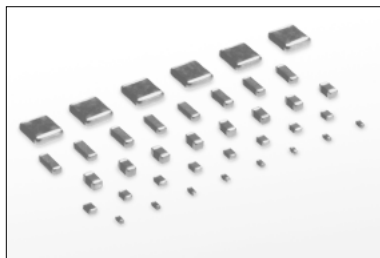

The NZ Series covers a wide range of impedance characteristics, from bead inductors to toroidal chips. These chip inductors have complete monolithic structures that are designed to prevent electromagnetic interference.

### Features

- Can be soldered either flow or reflow
- Tape and reel packaging that conforms with EIA standards
- Two different materials (High Q, High Loss) are also available with EIA0603, 0805 package size

### Applications

- Personal computers, work stations, office computers, electronic diaries, and other microcomputer related equipment
- Computer peripherals and terminals
- Prevention of noise emissions from these types of electronic equipment:
- Prevention of loopback and spurious radiation of unnecessary signals from clock oscillators
- Prevention of loopback and spurious radiation of unnecessary signals from various interfaces, excluding RGB and composite video signals

### Dimensions (mm)

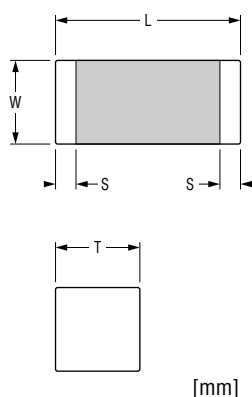

### Specifications

Model	Typical Impedance (Ω)	Rated Current (mA)	DC Resistance (Ω) max	Remarks	L	W	T	S
N1608ZA300	30 at 100MHz	100	0.4	High Loss type	1.6±0.15	0.8±0.15	0.8±0.15	0.1 (min.)
N1608ZA800	80 at 100MHz	100	0.5	High Loss type	1.6±0.15	0.8±0.15	0.8±0.15	0.1 (min.)
N1608ZA331	330 at 100MHz	100	0.6	High Loss type	1.6±0.15	0.8±0.15	0.8±0.15	0.1 (min.)
N1608ZA601	600 at 100MHz	100	0.8	High Loss type	1.6±0.15	0.8±0.15	0.8±0.15	0.1 (min.)
N1608ZA102	1000 at 100MHz	100	1.2	High Loss type	1.6±0.15	0.8±0.15	0.8±0.15	0.1 (min.)
N1608ZA202	2000 at 60MHz	100	1.8	High Loss type	1.6±0.15	0.8±0.15	0.8±0.15	0.1 (min.)
N1608Z300	30 at 100MHz	100	0.1	High Q type	1.6±0.15	0.8±0.15	0.8±0.15	0.1 (min.)
N1608Z800	80 at 100MHz	100	0.2	High Q type	1.6±0.15	0.8±0.15	0.8±0.15	0.1 (min.)
N1608Z121	120 at 100MHz	100	0.2	High Q type	1.6±0.15	0.8±0.15	0.8±0.15	0.1 (min.)
N1608Z301	300 at 100MHz	100	0.3	High Q type	1.6±0.15	0.8±0.15	0.8±0.15	0.1 (min.)
N1608Z601	600 at 100MHz	100	0.5	High Q type	1.6±0.15	0.8±0.15	0.8±0.15	0.1 (min.)
N1608Z102	1000 at 100MHz	100	0.7	High Q type	1.6±0.15	0.8±0.15	0.8±0.15	0.1 (min.)
N2012ZA800	80 at 100MHz	300	0.2	High Loss type	2.0±0.2	1.2±0.3	1.0±0.3	0.2 (min.)
N2012ZA121	120 at 100MHz	300	0.2	High Loss type	2.0±0.2	1.2±0.3	1.0±0.3	0.2 (min.)
N2012ZA601	600 at 100MHz	200	0.5	High Loss type	2.0±0.2	1.2±0.3	1.0±0.3	0.2 (min.)
N2012ZA102	1000 at 60MHz	100	1.0	High Loss type	2.0±0.2	1.2±0.3	1.0±0.3	0.2 (min.)
N2012Z260	26 at 100MHz	600	0.05	High Q type	2.0±0.2	1.2±0.3	1.0±0.3	0.3 (min.)
N2012Z121	120 at 100MHz	300	0.3	High Q type	2.0±0.2	1.2±0.3	1.0±0.3	0.3 (min.)
N2012Z221	220 at 100MHz	200	0.4	High Q type	2.0±0.2	1.2±0.3	1.0±0.3	0.3 (min.)
N2012Z301	300 at 100MHz	200	0.4	High Q type	2.0±0.2	1.2±0.3	1.0±0.3	0.3 (min.)
N2012Z601	600 at 100MHz	200	0.6	High Q type	2.0±0.2	1.2±0.3	1.0±0.3	0.3 (min.)
N2012Z102	1000 at 100MHz	100	1.0	High Q type	2.0±0.2	1.2±0.3	1.0±0.3	0.3 (min.)
N2012Z202	2000 at 60MHz	100	1.2	High Q type	2.0±0.2	1.2±0.3	1.0±0.3	0.3 (min.)
N3216Z800	80 at 100MHz	100	0.5		3.2±0.2	1.6±0.2	1.6±0.2	0.3 (min.)
N3216Z151	150 at 100MHz	100	0.3		3.2±0.2	1.6±0.2	1.1±0.3	0.3 (min.)
N3216Z501	500 at 100MHz	100	0.5		3.2±0.2	1.6±0.2	1.1±0.3	0.3 (min.)
N3216Z122	1200 at 50MHz	100	1.0		3.2±0.2	1.6±0.2	1.35±0.3	0.3 (min.)
N3216Z202	2000 at 30MHz	100	1.5		3.2±0.2	1.6±0.2	1.6±0.3	0.3 (min.)
N3216ZP500T25	50 at 100MHz	2500	0.02		3.2±0.2	1.6±0.2	1.35±0.3	0.3 (min.)
N4516ZP600T60	60 at 100MHz	6000	0.02		4.5±0.3	1.6±0.3	1.3±0.2	0.3 (min.)
N4516Z600	60 at 100MHz	2500	0.04		4.5±0.3	1.6±0.3	1.3±0.2	0.3 (min.)
N4516Z800	80 at 100MHz	600	0.08		4.5±0.3	1.6±0.3	1.3±0.2	0.3 (min.)
N4532ZP121T60	120 at 100MHz	6000	0.02		4.5±0.3	3.2±0.3	1.5±0.3	0.3 (min.)
N5750Z501	500 at 100MHz	3000	0.04		5.7±0.3	5.0±0.3	1.6±0.2	0.3 (min.)

## Multi-layered Chip Impedance Array

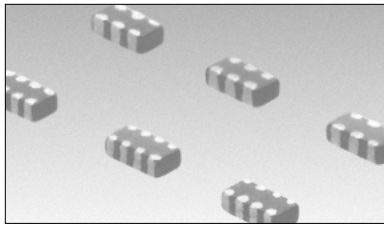

Surface mounted EMI countermeasure components that suppress noise on three or four lines in one chip, making them ideal for high density circuit design.

### Features

- Compact size and wide range of specifications.  
 Triple in-line packages: 30Ω, 120Ω, 200Ω, 3030Ω, 600Ω, 1000Ω  
 Quadruple in-line packages: 30Ω, 120Ω, 200Ω, 300Ω, 600Ω, 1000Ω

### Features

- Personal computers, work stations, office computers, electronic diaries, and other microcomputer related equipment.
- Computer peripherals and terminals.
- Prevention of noise emissions from various electronic equipment.
- Prevention of loopback and spurious radiation of unnecessary signals from clock oscillators and various other interfaces, excluding RGB and composite video signals.

### Circuit Diagram

#### • 3 Line

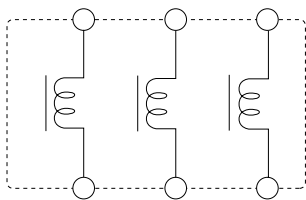

#### • 4 Line

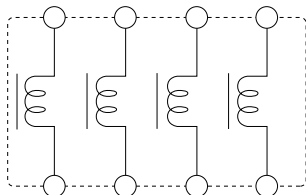

### Shapes and Dimensions

#### • 3 Line

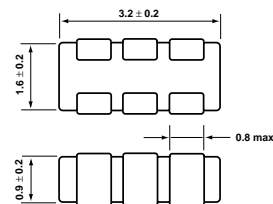

#### • 4 Line

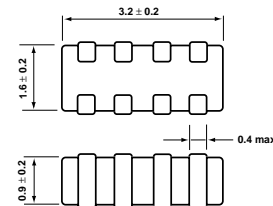

### Markings

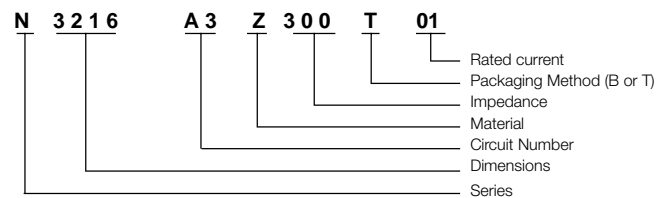

### Specifications

Model	Impedance (Ω)	DC Resistance (mΩ)	Rated Current (mA)	Operating Temperature (°C)	Storage Temperature (°C)
N3216A3Z300□01	25 min. at 100MHz	100	100	- 55°C ~ 125°C	- 55°C ~ 125°C
N3216A3Z121□01	120 ± 25% at 100MHz	200	100		
N3216A3Z201□01	200 ± 25% at 100MHz	300	100		
N3216A3Z301□01	300 ± 25% at 100MHz	450	100		
N3216A3Z601□01	600 ± 25% at 100MHz	500	100		
N3216A4Z102□01	1000 ± 25% at 100MHz	800	100		
N3216A4Z300□01	25 min. at 100MHz	100	100		
N3216A4Z121□01	120 ± 25% at 100MHz	200	100		
N3216A4Z201□01	200 ± 25% at 100MHz	300	100		
N3216A4Z301□01	300 ± 25% at 100MHz	450	100		
N3216A4Z601□01	600 ± 25% at 100MHz	500	100		
N3216A4Z1020□01	1000 ± 25% at 100MHz	800	100		

#### • 3 Line

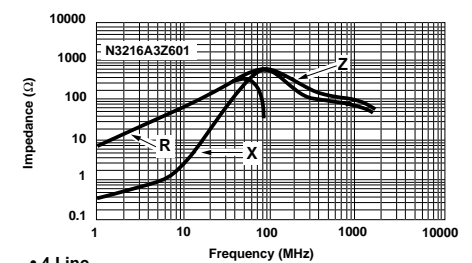

#### • 4 Line

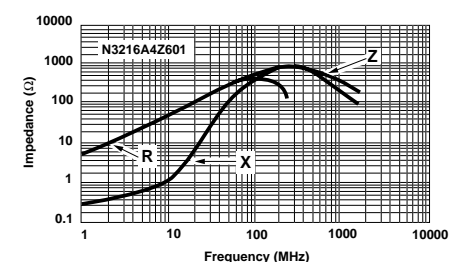

### Three-Terminal EMI Chip Filters (E4525T Series)

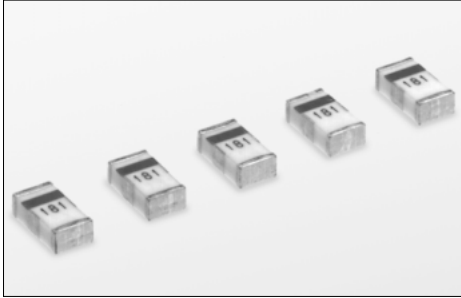

**Features**

- High attenuation over a wide band
- Available in 4 models to suit the EMI suppression effect ideal to your needs
- Superior circuit matching characteristics
- Can be soldered by flow or flow or reflow machines

**Applications**

- Clock signal lines (5 to 60MHz)
- High resolution video signal lines
- EMI suppression of secondary signals

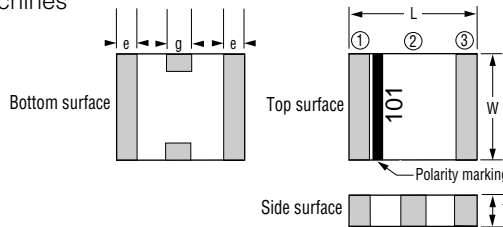

Dimensions (mm)	
L	4.5 ± 0.3
W	2.5 ± 0.3
T	1.4 ± 0.3
g	1.0 ± 0.3
e	0.1 min.

This three-terminal noise suppressor is surface mounted type and is used to eliminate spurious noise from high speed data lines of electronic equipment.

Rated voltage DC (V)	Rated current DC (mA)	Withstand voltage DC (V)	Insulation resistance (M $\Omega$ ) min.	Operating temperature range °C
50	200	125	10 <sup>4</sup>	-40 ~ +85

**Circuit Construction**

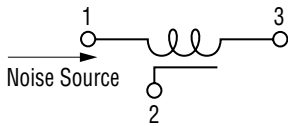

Model	Static capacitance pF	Inductance nH	Attenuation (dB) / Frequency (MHz)		
			0dB	3dB	10dB
E4525T300	30	25	70	210	370
E4525T500	60	25	30	110	220
E4525T101	110	25	20	60	140
E4525T181	190	25	10	30	90

Note: Tape and Reel Packaging is available.

### Three-Terminal EMI Chip Filters (E3216T Series)

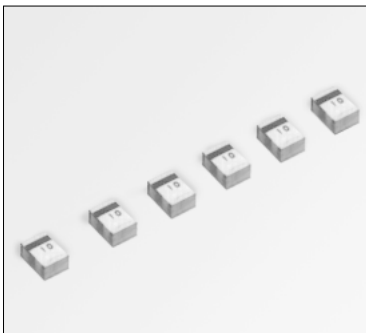

Tokin has implemented compact and high-performance terminal noise suppressors (measuring 3.2L x 1.6W x 2.5T mm) by using low-temperature burned ceramics.

**Features**

- Has a pitch width of 1.6 mm, parallel mountable on ICs with 2.54mm pitches
- Requires about the one-half the mounting area compared with E4525T series (low-profile type), allowing high density packaging

**Applications**

- Clock signal circuits (5 to 60MHz)
- I/O circuits for super-high-resolution videos (EGA, VGA, ULTRA, VGA, etc.)
- Noise elimination for signal circuits

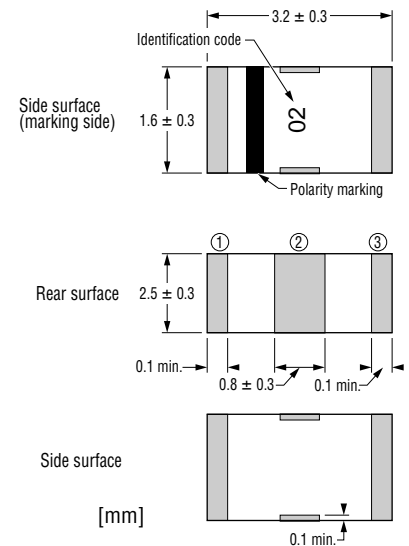

**Circuit Construction**

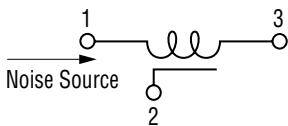

**Specifications**

Note: Tape and Reel Packaging is available.

Rated voltage DC (V)	Rated current DC (mA)	Withstand voltage DC (V)	Insulation resistance (M $\Omega$ ) min.	DC resistance (m $\Omega$ ) max.	Operating temperature range (°C)
50	500	125	10 <sup>4</sup>	300	-25 ~ +85

Model	Static capacitance (pF)	Inductance (nH)	Attenuation (dB) / Frequency (MHz)		Code
			≥ 10dB	≥ 20dB	
E3216T100	10	11	(1250 ~ 2000)	(1500)	01
E3216T200	20	17	710 ~ 2000	970	02
E3216T400	45	37	360 ~ 1000	530	07
E3216T800	85	37	220 ~ 1000	350	10
E3216T181	190	37	120 ~ 1000	210	12

### Three-Terminal EMI Chip Filters (E3216C Series)

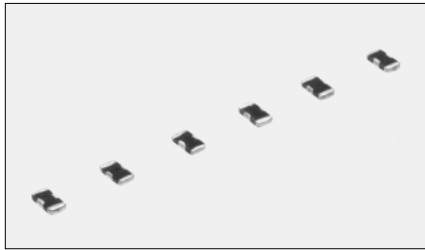

This three-terminal chip ceramic capacitor boasts excellent high frequency characteristics. Its small size and surface-mount configuration make it ideal as a countermeasure against high frequency spurious noise.

#### Features

- Three terminal construction enables noise suppression at high frequencies
- Ceramic single-plate construction provides high reliability
- Plated electrodes insure excellent solder dip resistance

#### Applications

- Personal computers and peripherals
- Automotive electronics
- Noise immunity for TV's and VCR's
- Countermeasure against spurious noise interference in wireless communications equipment

#### Shape and Dimensions

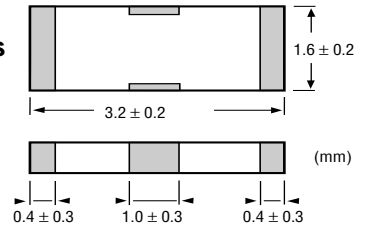

#### Specifications

Model	Electrostatic Capacity (pF)	Capacitance/Tolerance (pF)	Rated Voltage DC (V)	Rated current AC (mA)	Dielectric resistance (MΩ) min.
E3216C101	100	+50% -20	25	220	1000
E3216C221	220				
E3216C471	470				
E3216C102	1000				
E3216C222	2200				

#### Circuit Construction

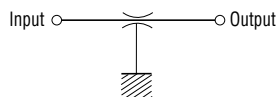

### Three-Terminal EMI Chip Filters (E3216RA/RB Series)

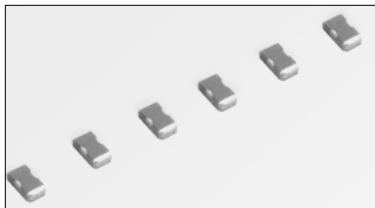

These RC filters are T-type filters which include a resistor added to a line of three-terminal chip ceramic capacitors, resulting in superior high frequency characteristics.

#### Features

- Provides attenuation over a wider range as a result of the addition of a capacitor to a three-terminal chip capacitor
- Allows noise elimination up to high frequency range as a result of a three-terminal construction with superior frequency responses
- High reliability because of the use of ceramics
- Adopts plated terminal electrodes with superior solderability and solder heat resistance

#### Applications

- Countermeasures against noise emitted from personal computers or OA equipment

#### Dimensions

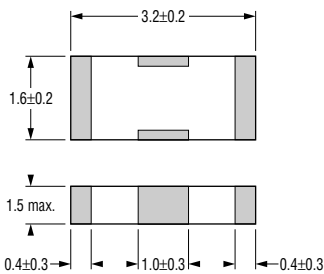

#### Specifications

DC (W)	Rated current DC (mA)	Insulation resistance (MΩ) min.	Operating temperature range (°C)	Capacitance allowance (%)	Resistance allowance (%)
1/16	25	10 <sup>3</sup>	-25 ~ +85	+50 -20	±30

Model	Capacitance (pF)	DC resistance (Ω)
E3216RA221	220	100
E3216RA101	100	100
E3216RA470	47	100
E3216RA220	22	100
E3216RB221	220	50
E3216RB101	100	50
E3216RB470	47	50
E3216RB220	22	50

Note: Tape and Reel Packaging is available.

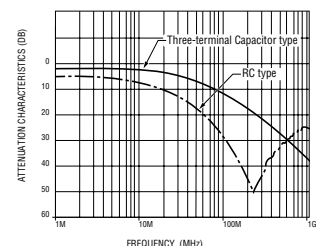

#### Numbering System

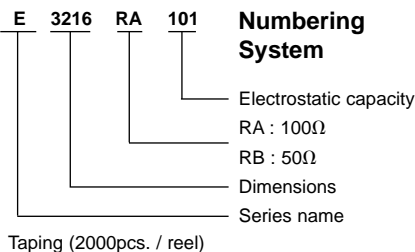

## Chip Varistor

SMD Type Chip Varistor provides highly reliable surface mount application.

### Features

- High surge resistance: 100 to 270A
- ZnO ceramic varistor

### Applications

- ESD countermeasures, burst noise protection measures
- Signal I/O, motor drive circuits

### Specifications

Part No.	Rated current		Varistor Voltage at 10A (1mA DC) Va (V)	Maximum Input Voltage (8/20 μs) Vc (V)	Maximum Surge Voltage (8/20 μs) Ia (A)	Maximum Surge Energy (10/1000 μs) Wa (J)	Capacitance at f=1MHz Cp (pF)
	Vw (DC) (V)	Vw (AC) (V)					
V2012A3R5J□□	3.5	2.5	3.7 ~ 5.5	14	100	0.3	100 ~ 2000
V2012A5R5J□□	5.5	4.0	7.1 ~ 9.3	16	150	0.4	
V2012A140J□□	14	10	15.9 ~ 20.3	30	150	0.4	
V2012A180J□□	18	14	22.5 ~ 28.0	40	250	0.8	
V2012A260J□□	26	20	29.5 ~ 38.5	56	250	1.2	
V2012A330J□□	33	26	38.0 ~ 45.0	72	180	0.8	
V2012A420J□□	42	30	46.0 ~ 56.0	86	180	0.8	
V2012A560J□□	56	40	61.0 ~ 76.0	110	180	1.0	
V2012A680J□□	68	50	76.0 ~ 90.0	130	180	1.0	
V3216A3R5J□□	3.5	2.5	3.7 ~ 5.5	14	130	0.4	
V3216A5R5J□□	5.5	4.0	7.1 ~ 9.3	16	180	0.6	
V3216A140J□□	14	10	15.9 ~ 20.3	30	180	0.6	
V3216A180J□□	18	14	22.5 ~ 28.0	40	270	1.0	
V3216A260J□□	26	20	29.5 ~ 38.5	56	270	1.5	
V3216A330J□□	33	26	38.0 ~ 45.0	72	210	0.9	
V3216A420J□□	42	30	46.0 ~ 56.0	86	210	0.9	
V3216A560J□□	56	40	61.0 ~ 76.0	110	210	1.3	
V3216A680J□□	68	50	76.0 ~ 90.0	130	210	1.3	

### Shapes and Dimensions

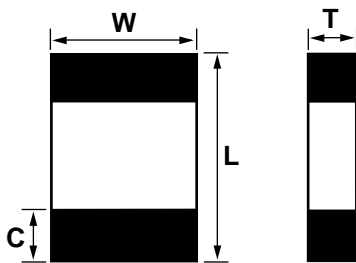

(mm)

	L	W	T	C min.
<b>N2012</b>	2.0 ± 0.2	1.25 ± 0.2	1.0 ± 0.2	0.1
<b>N3216</b>	3.2 ± 0.2	1.60 ± 0.2	1.3 ± 0.2	0.2

### Impedance Characteristics (Reference Data)

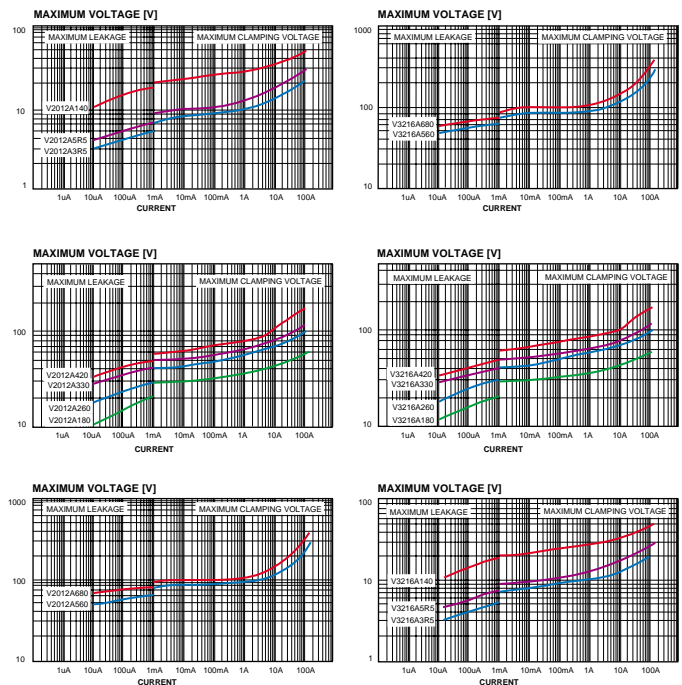

### Markings

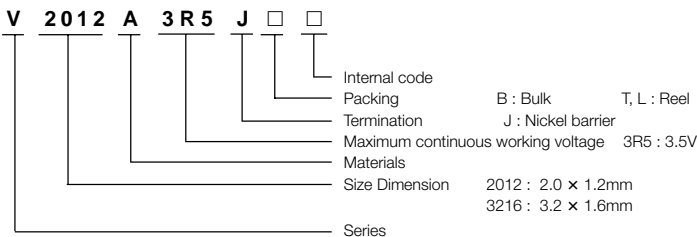

## EMI Suppressor Sheets – “Flex Suppressor”

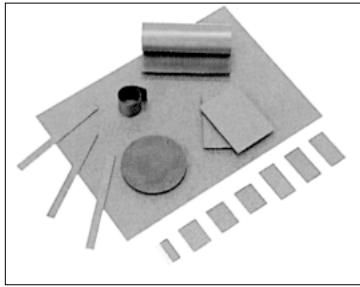

Soft magnetic sheets designed to efficiently suppress a wide range of high frequency radiation noise generated in various electronic equipment. They can serve as excellent EMC suppressors of high frequency noise difficult to countermeasure with conventional ferrite/ ceramic materials.

### Features

- Usable in quasi microwave ranges - can be used in high-speed clocks (100 MHz to 3 GHz)
- Thin (0.3 to 2mm), flexible material - can be used in portable equipment
- Virtually no limitation to where it can be used.
- Easy to process, suitable for a wide variety of applications, available in custom sizes
- High electrical resistance ( $10^6$  to  $10^8$  ohms) - functions as an absorber
- Includes non-conductive adhesive backing

### Features

- Radiation noise suppression in all kinds of electronic equipment
- Intra-system application to suppress noises in quasi microwave ranges
- Virtually no limitation to where it can be used: mobile communications equipment, wireless equipment (BS, CS tuners), office automation equipment (personal computers, TFT LCD's, etc.), communications terminals in audio audio/video equipment, digital exchanges, etc.

### Type and Specifications

Type	Standard Thickness (mm)	Structure	Operating Temperature (°C)	Standards Listed
K4E	0.5	Single Layer	-20 to +80	UL94-V1
	1.0			

Standard size (mm)	Applications
25 × 15	ASIC, IC, etc.
50 × 20	Flat cable, clock generator, etc.
70 × 50	PC, workstation, etc.
210 × 150	ATM, etc.

When and where Flex Suppressor sheets are used:

Case 1: To suppress noise generated by casing.

Case 2: To suppress noise generated between PCB boards.

Case 3: To suppress unwanted radiation of noises from LSI, IC and cables.

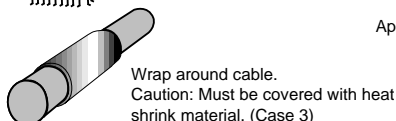
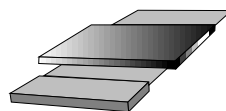
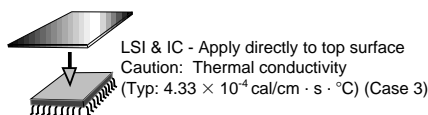
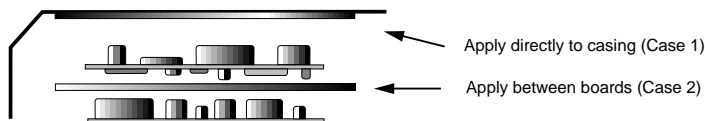

### Characteristics

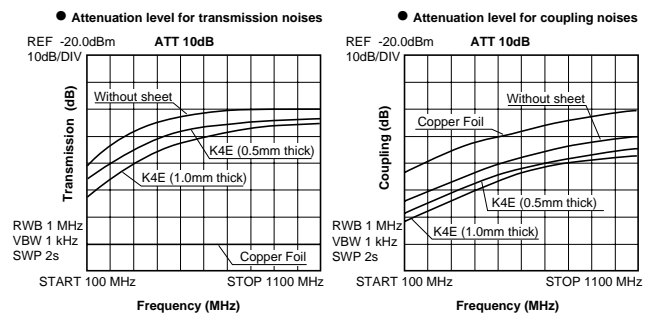

### Measurement Method

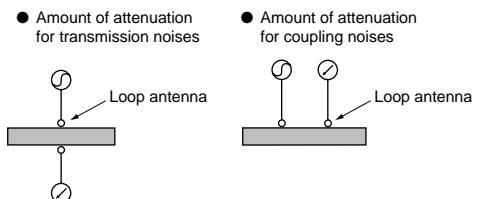



## EMC Chip Filters (M-500 Series)

The key to suppressing radiated noise emissions generated by electronic equipment and systems is the successful application of effective countermeasures at the data lines. To answer your need for high-performance EMC components for designing data lines between central processing units and terminals, Tokin has developed outstanding compact filters that enable easy surface mounting.

### Features

- Can be mounted using flow or reflow soldering
- The ideal countermeasure against common-mode noise in the signal transmission lines of data communications terminals and digital equipment
- Highly effective in suppressing radiated emissions per FCC, VDE and VCCI standards.

### Applications

- TVs, FM/AM tuners, VTR/VCRs
- Personal computers, equipment using microcomputers, peripheral terminals
- Data terminals

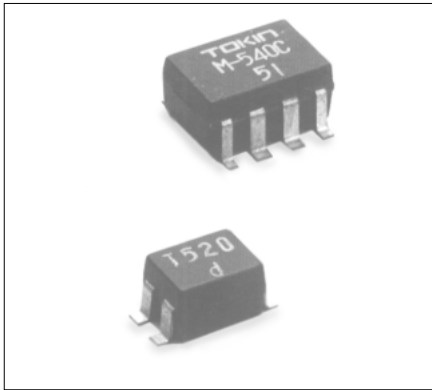

### Specifications

Model Bulk	Model Tape & Reel	Frequency Range (MHz)	Rated Current (mA)	Remarks
M-520C	M-520CT	20 ~ 300	1000	2 line Common mode (Molded)
M-521C	M-521CT	1 ~ 300	1000	2 line Common mode (Non-Molded)
M-522C	M-522CT	20 ~ 300	1000	2 line Common mode (Non-Molded)
M-532C	M-532CT	20 ~ 300	500	3 line Common mode (Non-Molded)
M-538C	M-538CT	20 ~ 300	100	3 line Common mode (Non-Molded)
M-540C	M-540CT	20 ~ 300	100	4 line Common mode (Molded)
M-542C	M-542CT	20 ~ 300	500	4 line Common mode (Non-Molded)

### Dimensions

(mm)

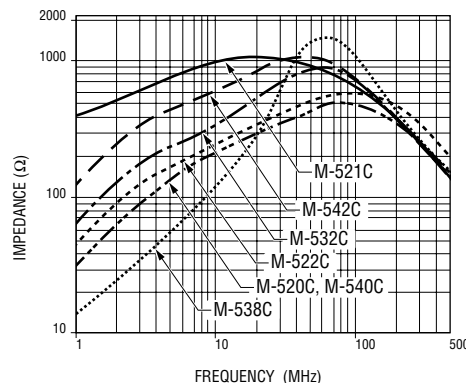
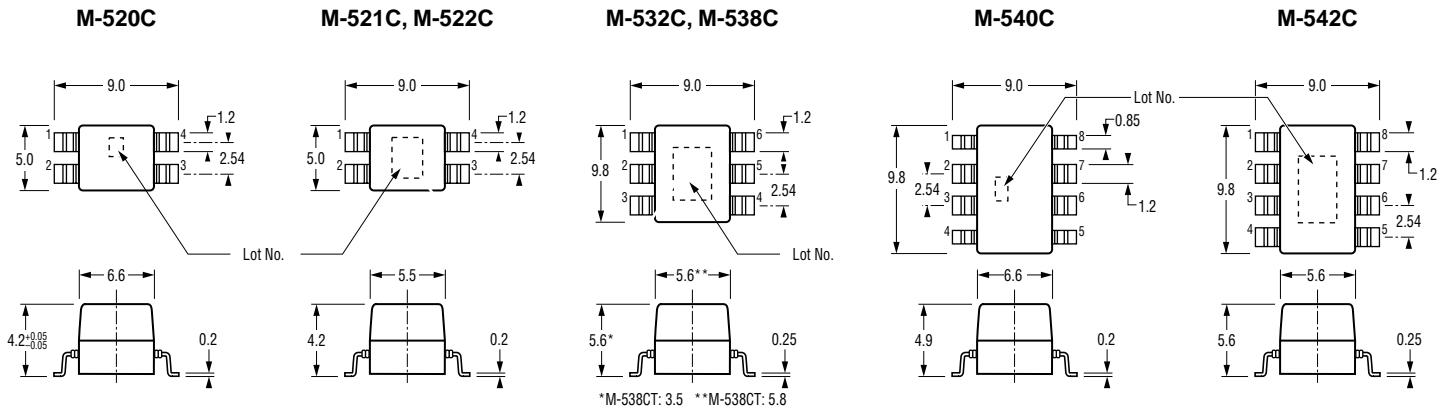

## DC Line Filters – SBP Series

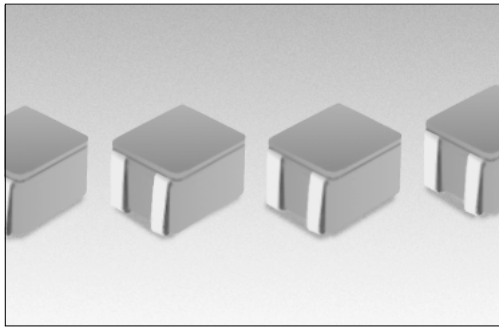

These SMD type filters are effective in counteracting noise in DC lines.

### Features

- Employs high-performance ferrites with excellent frequency characteristics
- Compact sized SMD type common mode choke coils designed for easy mounting on PC boards

### Applications

- Countermeasures against radiated noise in computers, word processors and microcomputers
- Countermeasures against output common mode noise in switching power supplies and AC adapters

### Specifications

Model	Rated Current (A)	Rated Voltage (DCV)	Impedance (Ω) Typ.	DC Resistance (mΩ/line) Typ.
SBP-5001	5	50	750	3.6

### Shapes and Dimensions

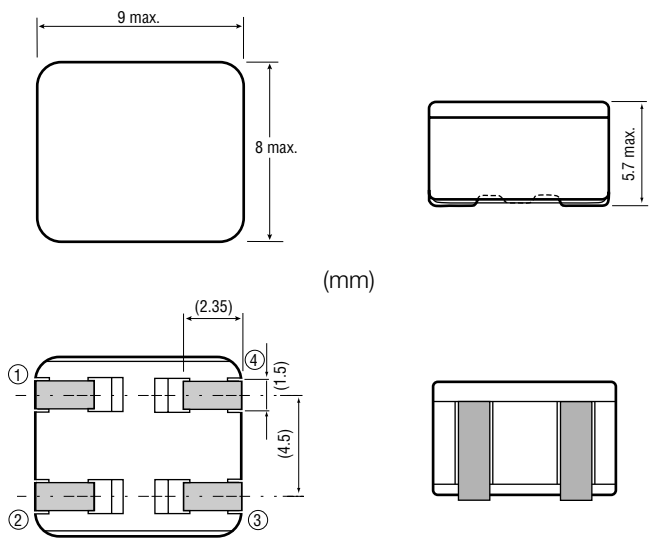

### Circuit Diagram

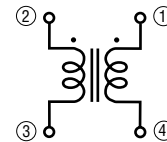

### Impedance Characteristics

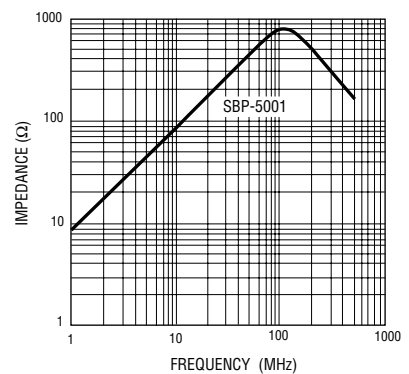

## SBT Coils

Employing a high-performance ferrite toroidal core, Tokin SB coils provide ideal countermeasures against EMI.

### Features

- Employ high-performance ferrites with superior frequency characteristics
- Compact size, high-performance and low cost

- Available in tape format for automatic installation
- Enable common-mode noise suppression without influencing video signals
- L-element circuit ensures excellent attenuation characteristics over a wide frequency range

### Applications

- EMI countermeasures at signal lines of personal computers, microcomputers, peripheral devices, etc.
- Countermeasures against common-mode noise at composite video signals

## SBT-W Series

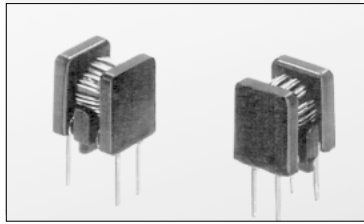

Model	Rated Current (mA)	Inductance (1kHz, 70mA) (μH)	DC Resistance (mΩ) max.	Packaging
SBT-0115W	500	≧ 5	30	Loose types
SBT-0140W	500	40 ± 35%	40	Loose types
SBT-0160W	500	60 ± 35%	45	Loose types
SBT-0180W	500	80 ± 35%	55	Loose types

- Rated voltage: 50V
- Test voltage: 200V.DC for one minute between lines
- Insulation resistance: More than 10MV (100 V.DC, between lines)
- Operating temperature: -25 , +708C

### Circuit Construction

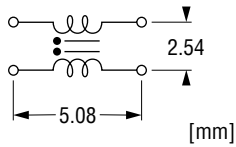

### Dimensions

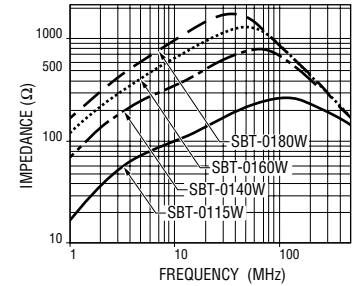
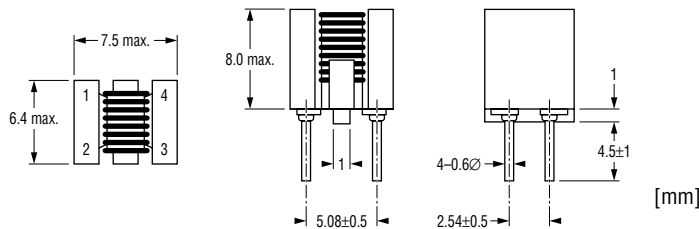

## SBT-03W Series

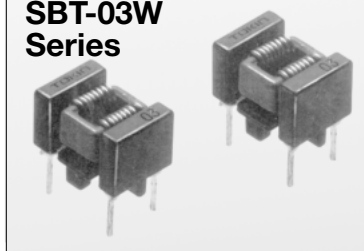

Model	Rated Voltage DC (V)	Rated Current (A)	Inductance at 100kHz, 1mA (μH) min.	DC Resistance (mΩ) max.	Operating Temperature °C
SBT-0308W	50	3.0	6.75	20	-25~+85
SBT-0310W	50	2.5	7.7	30	-25~+80
SBT-0315W	50	2.0	11.9	45	-25~+75

### Circuit Construction

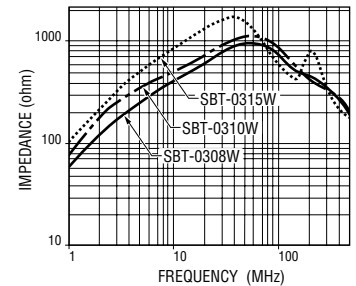
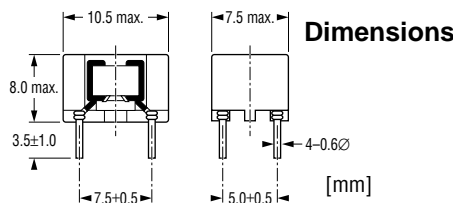
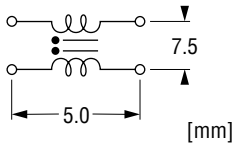

## SBT Series

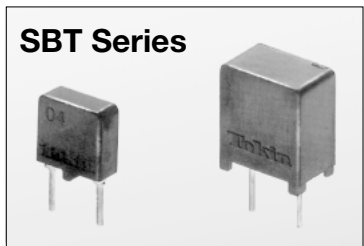

Model	Rated Current (mA)	Inductance (1kHz, 70mA) (μH)	DC Resistance (mΩ) max.	Packaging
SBT-0208 □	500	8 ± 50%	20	Loose/tape types
SBT-0210 □	500	10 ± 50%	20	Loose/tape types
SBT-0240 □	500	40 ± 35%	34	Loose/tape types
SBT-0260 □	500	60 ± 35%	50	Loose/tape types

### Dimensions

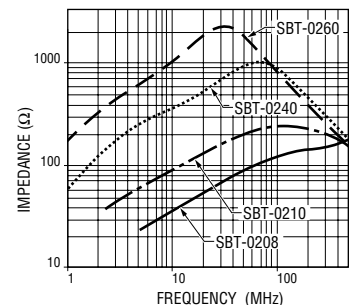
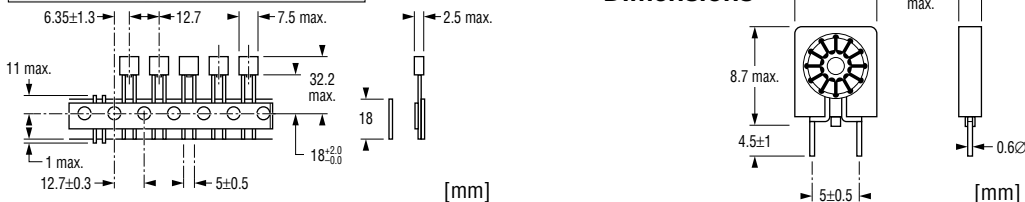

## Data Line Filters

Merely inserting EMI filters in the power line is sometimes not completely effective in reducing the susceptibility of electronic equipment to external noise. For example, high frequency signals may enter directly through the

equipment case. In such cases, Tokin Data Line Filters, utilizing Tokin's own high-grade ferrite materials, can be applied directly to signal or data lines to help reduce noise susceptibility.

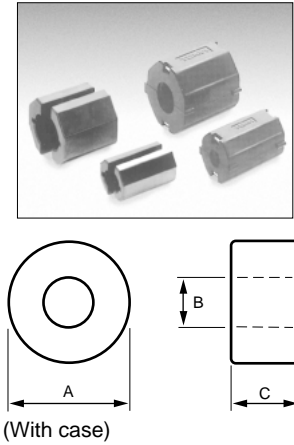
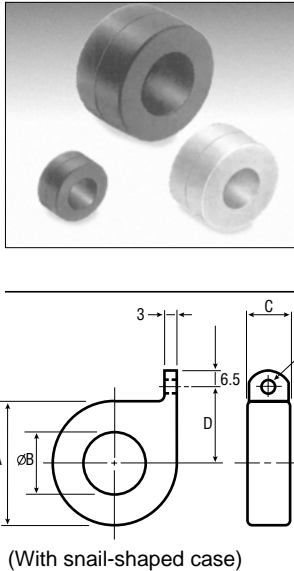
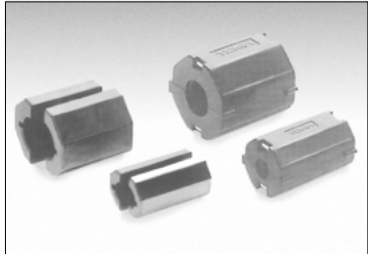
	Model	Dimensions (mm)				Frequency Range	Remarks
		A	B	C	D		
<b>ESD-R Series</b>  	<b>ESD-R-10D</b>	9.5	5.0	10.0		~300 MHz	
	<b>ESD-R-10S</b>	10.5	5.5	20.0		~300 MHz	
	<b>ESD-R-12A</b>	11.8	7.3	15.0		~100 MHz	
	<b>ESD-R-12C</b>	11.8	7.3	15.0		~300 MHz	
	<b>ESD-R-12E</b>	11.8	7.3	8.0		~300 MHz	
	<b>ESD-R-12F</b>	12.0	8.5	15.0		~300 MHz	
	<b>ESD-R-12S</b>	12.0	7.0	5.5		~300 MHz	
	<b>ESD-R-14A</b>	14.0	7.0	3.0		~100 MHz	Coated core
	<b>ESD-R-14C</b>	14.0	7.0	3.0		~100 MHz	
	<b>ESD-R-14S</b>	14.3	6.3	28.5		~300 MHz	
	<b>ESD-R-15C</b>	15.2	10.5	12.5		~300 MHz	
	<b>ESD-R-16</b>	15.9	11.6	8.4	—	~100 MHz	
	<b>ESD-R-16C</b>	16.0	9.0	17.0		~300 MHz	
	<b>ESD-R-17S</b>	17.5	9.5	28.5		~300 MHz	
	<b>ESD-R-19SD</b>	18.5	10.0	10.0		~300 MHz	
	<b>ESD-R-19E-1</b>	19.0	10.7	5.3		~300 MHz	Coated core
	<b>ESD-R-25SD</b>	25.0	15.0	12.0		~300 MHz	
	<b>ESD-R-25S</b>	25.0	15.0	12.0		~100 MHz	
	<b>ESD-R-25L-A</b>	25.3	15.1	12.1		~300 MHz	Coated core
	<b>ESD-R-26S</b>	26.0	13.0	28.5		~300 MHz	
<b>ESD-R-28C</b>	28.0	16.0	13.0		~300 MHz		
<b>ESD-R-31C</b>	31.0	19.0	8.0		~300 MHz		
<b>ESD-R-12D</b>	12.9	6.0	6.4		~300 MHz		
<b>ESD-R-19</b>	19.0	9.0	11.0		~100 MHz		
<b>ESD-R-19D</b>	19.0	9.0	11.0		~300 MHz		
<b>ESD-R-25</b>	26.0	14.0	15.0		~100 MHz		
<b>ESD-R-25D</b>	26.0	14.0	15.0	—	~300 MHz		
<b>ESD-R-38</b>	39.0	17.5	14.0		~100 MHz		
<b>ESD-R-47</b>	48.0	25.5	16.0		~100 MHz		
<b>ESD-R-57</b>	61.0	32.4	24.0		~100 MHz		
<b>ESD-R-19B</b>	21.5	8.8	12.5	18.5	~100 MHz	Color of case: White	
<b>ESD-R-19DB</b>	21.5	8.8	21.5	18.5	~300 MHz	Black	
<b>ESD-R-25B</b>	29.3	13.9	15.0	23.0	~100 MHz	White	
<b>ESD-R-25D-B</b>	29.3	13.9	15.0	23.0	~300 MHz	Black	
<b>ESD-R-38B</b>	42.4	17.9	16.0	28.0	~100 MHz	White	
<b>ESD-R-47B</b>	51.5	25.5	17.5	34.0	~100 MHz	White	
<b>ESD-SR Series</b> 	<b>ESD-SR-12</b>	19.0 max.	30.0 max.			~300 MHz	
	<b>ESD-SR-12-S</b>	12.0	25.3			~300 MHz	W/O case
	<b>ESD-SR-15</b>	22.5 max.	33.5 max.	—	—	~300 MHz	
	<b>ESD-SR-15-S</b>	15.0	28.3			~300 MHz	W/O case
	<b>ESD-SR-25</b>	33.0 max.	33.5 max.			~300 MHz	
<b>ESD-SR-25-S</b>	25.0	23.0			~300 MHz	W/O case	

Data Line Filters (cont.)

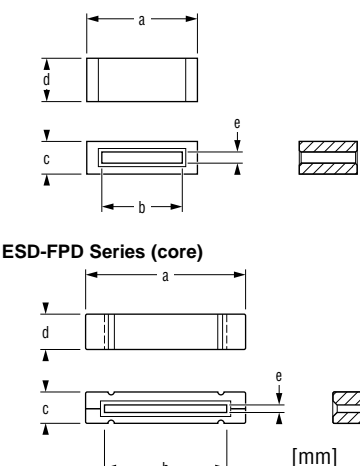
ESD-FPL Series	Model	Dimensions (mm)					Applications	Remarks
		a	b	c	d	e		
 <p>ESD-FPD Series (core)</p>	ESD-FPL-7	28.0	23.5	7.7	6.8	1.5	16 Core	ESD-FPL-34-R: Coated  Hinged type, stainless clamp Hinged type, nylon clamp Hinged type, stainless clamp Hinged type, nylon clamp Hinged type, stainless clamp Hinged type, nylon clamp Hinged type, stainless clamp Hinged type, nylon clamp Hinged type, stainless clamp Hinged type, nylon clamp
	ESD-FPL-13	23.8	18.8	6.3	15.0	1.1	13 Core	
	ESD-FPL-15	28.0	23.5	7.7	14.6	1.5	16 Core	
	ESD-FPL-16	37.0	25.4	12.0	12.7	1.9	16 Core	
	ESD-FPL-20-12	33.2	27.0	8.0	12.0	1.5	20 Core	
	ESD-FPL-20-15	33.2	27.0	8.0	15.0	1.5	20 Core	
	ESD-FPL-26	41.2	35.0	7.7	15.0	1.5	26 Core	
	ESD-FPL-34	60.0	48.5	12.0	12.7	2.2	34 Core	
	ESD-FPL-50	80.0	68.6	12.0	12.7	1.9	50 Core	
	ESD-FPD-16	37.0	25.4	10.0	12.7	2.6	16 Core	
	ESD-FPD-16-1	37.0	25.4	10.0	12.7	2.6	16 Core	
	ESD-FPD-34	60.0	48.3	10.0	12.7	2.0	34 Core	
	ESD-FPD-34-1	60.0	48.3	10.0	12.7	2.0	34 Core	
	ESD-FPD-40	68.0	56.0	10.0	12.7	2.0	40 Core	
	ESD-FPD-40-1	68.0	56.0	10.0	12.7	2.0	40 Core	
	ESD-FPD-50	80.0	68.6	10.0	12.7	2.0	50 Core	
ESD-FPD-50-1	80.0	68.6	10.0	12.7	2.0	50 Core		

Bead Inductors

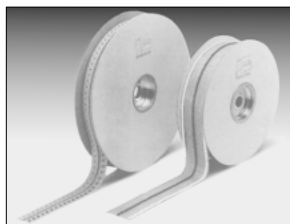

Model	Type	Packaging
B-01-AT	Axial lead tape	5000 reel
B-01-AT1F		2000 flat
B-01-A		loose type
B-01-RT		2000 reel
B-01-RTF		2000 flat
B-02-R	Radial lead tape	loose type
B-06-R-25		loose type
B-06-R-50		loose type
B-06-RTF-50		2000 reel

DIP Noise Filters

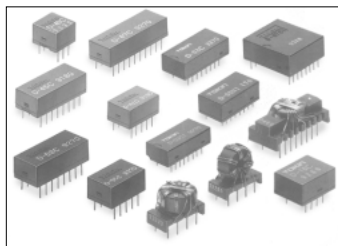

Model	Dimensions	Remarks
D-40C	8.72 × 10 × 9	6P/3 Common mode
D-42C	13.8 × 10 × 9	10P/5 Commonmode
D-45C	21.42 × 10 × 9	16P/8 Common mode
D-47C	26.5 × 10 × 9	20P/10 Common mode
D-55C	13.8 × 10 × 9	16P/5 Common mode
D-58C	21.42 × 10 × 9	16P/8 Common mode
D-22C	12 × 23 × 23	6P/3 Common mode
D-03C	25.5 × 12.5 × 7.5	16P/8 Common mode
D-03C1	25.5 × 12.5 × 7.5	16P/8 Common mode
D-07C1	25.5 × 22.5 × 10	16P/8 Common mode
D-08C2	12 × 21 × 20	8P/4 Common mode
D-08C2A	16 × 21 × 14	8P/4 Common mode
D-05N1	23 × 12.5 × 9	16P/8 Normal mode
D-16C	12.5 × 16 × 8.5	8P/4 Common mode
D-20C	13 × 25.5 × 11	16P/8 Common mode

SN Coils – SNT Series

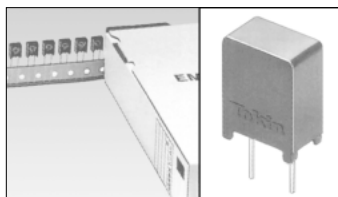

Model	Rated Current (A)	Inductance Min. (μH)	DC Resistance Max. (mΩ)	Dimensions Max. (mm)	Packaging
SNT-S10□□	3.0	1.5	25	2.5 × 9.5 × 5.0	Loose type/reel type
SNT-S20□□	1.5	6	35	12.5 × 9.5 × 5.0	Loose type/reel type
SNT-S30□□	0.5	13	95	12.5 × 9.5 × 5.0	Loose type/reel type
SNT-D10□□	3.0	2.5	25	12.5 × 9.5 × 6.0	Loose type/reel type
SNT-D20□□	1.5	10	45	12.5 × 9.5 × 6.0	Loose type/reel type
SNT-D30□□	0.5	20	98	12.5 × 9.5 × 6.0	Loose type/reel type

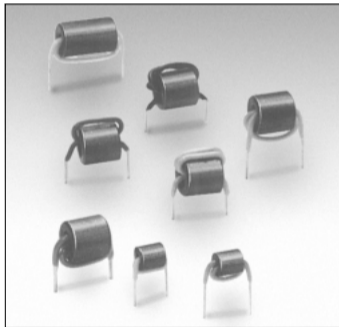
**Data Line Filters (cont.)**

**EMC Beads**

Model	Dimensions (mm)	Remarks
<b>B-1</b>	4.8 × 5.5	Inductive bead
<b>B-3</b>	6.8 × 9.0	Resistive bead
<b>B-4</b>	6.4 × 10.5	
<b>B-5</b>	6.4 × 11.0	
<b>B-7</b>	4.8 × 6.0	Inductive bead
<b>B-8</b>	–	Resistive bead
<b>B-9</b>	7.0 × 7.5	
<b>B-10</b>	–	