

# TLV2211, TLV2211Y

## Advanced LinCMOS™ RAIL-TO-RAIL MICROPOWER SINGLE OPERATIONAL AMPLIFIERS

SLOS156E – MAY 1996 – REVISED SEPTEMBER 2006

- Output Swing Includes Both Supply Rails
- Low Noise . . . 21 nV/√Hz Typ at f = 1 kHz
- Low Input Bias Current . . . 1 pA Typ
- Very Low Power . . . 11 μA Per Channel Typ
- Common-Mode Input Voltage Range Includes Negative Rail
- Wide Supply Voltage Range 2.7 V to 10 V
- Available in the SOT-23 Package
- Macromodel Included

### description

The TLV2211 is a single low-voltage operational amplifier available in the SOT-23 package. It consumes only 11 μA (typ) of supply current and is ideal for battery-power applications. Looking at Figure 1, the TLV2211 has a 3-V noise level of 22 nV/√Hz at 1kHz; 5 times lower than competitive SOT-23 micropower solutions. The device exhibits rail-to-rail output performance for increased dynamic range in single- or split-supply applications. The TLV2211 is fully characterized at 3 V and 5 V and is optimized for low-voltage applications.

The TLV2211, exhibiting high input impedance and low noise, is excellent for small-signal conditioning for high-impedance sources, such as piezoelectric transducers. Because of the micropower dissipation levels combined with 3-V operation, these devices work well in hand-held monitoring and remote-sensing applications. In addition, the rail-to-rail output feature with single or split supplies makes this family a great choice when interfacing with analog-to-digital converters (ADCs).

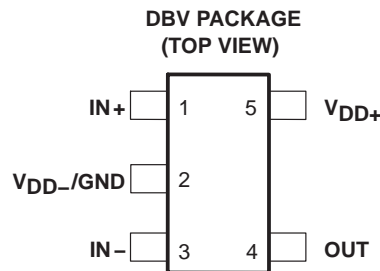

EQUIVALENT INPUT NOISE VOLTAGE†  
VS  
FREQUENCY

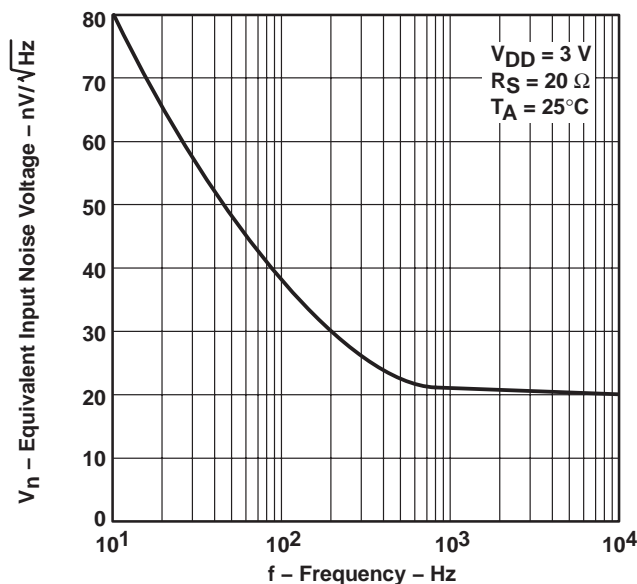

† All loads are referenced to 1.5 V.

**Figure 1. Equivalent Input Noise Voltage Versus Frequency**

### AVAILABLE OPTIONS

T <sub>A</sub>	V <sub>IOMax</sub> AT 25°C	PACKAGED DEVICES	SYMBOL	CHIP FORM‡ (Y)
		SOT-23 (DBV)†		
0°C to 70°C	3 mV	TLV2211CDBV	VACC	TLV2211Y
-40°C to 85°C	3 mV	TLV2211IDBV	VACI	

† The DBV package available in tape and reel only.

‡ Chip forms are tested at T<sub>A</sub> = 25°C only.



Please be aware that an important notice concerning availability, standard warranty, and use in critical applications of Texas Instruments semiconductor products and disclaimers thereto appears at the end of this data sheet.

Advanced LinCMOS is a trademark of Texas Instruments.

PRODUCTION DATA information is current as of publication date. Products conform to specifications per the terms of Texas Instruments standard warranty. Production processing does not necessarily include testing of all parameters.



POST OFFICE BOX 655303 • DALLAS, TEXAS 75265

Copyright © 2001–2006, Texas Instruments Incorporated

# TLV2211, TLV2211Y

## Advanced LinCMOS™ RAIL-TO-RAIL

### MICROPOWER SINGLE OPERATIONAL AMPLIFIERS

SLOS156E – MAY 1996 – REVISED SEPTEMBER 2006

---

#### description (continued)

With a total area of 5.6mm<sup>2</sup>, the SOT-23 package only requires one-third the board space of the standard 8-pin SOIC package. This ultra-small package allows designers to place single amplifiers very close to the signal source, minimizing noise pick-up from long PCB traces. TI has also taken special care to provide a pinout that is optimized for board layout (see Figure 2). Both inputs are separated by GND to prevent coupling or leakage paths. The OUT and IN– terminals are on the same end of the board to provide negative feedback. Finally, gain setting resistors and decoupling capacitor are easily placed around the package.

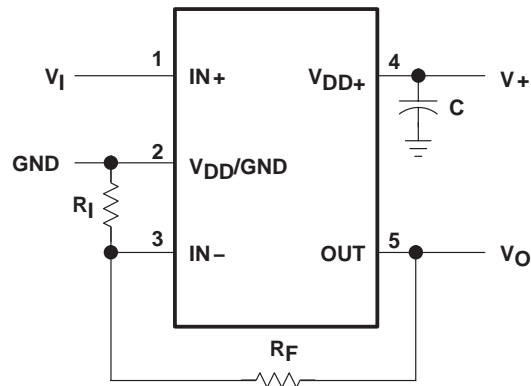
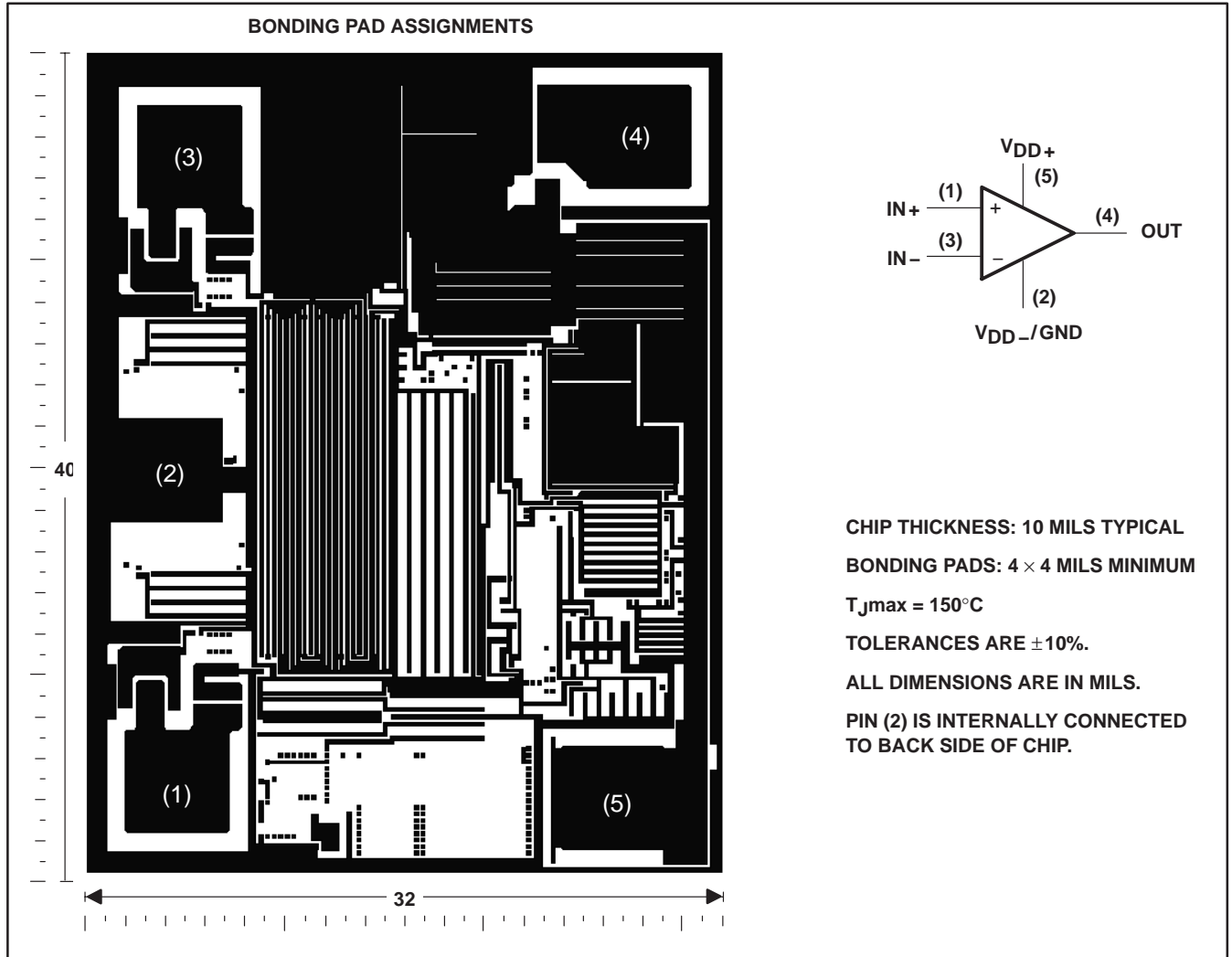

Figure 2. Typical Surface Mount Layout for a Fixed-Gain Noninverting Amplifier

**TLV2211Y chip information**

This chip, when properly assembled, displays characteristics similar to the TLV2211C. Thermal compression or ultrasonic bonding may be used on the doped-aluminum bonding pads. This chip may be mounted with conductive epoxy or a gold-silicon preform.



**TLV2211, TLV2211Y**  
**Advanced LinCMOS™ RAIL-TO-RAIL**  
**MICROPOWER SINGLE OPERATIONAL AMPLIFIERS**

SLOS156E – MAY 1996 – REVISED SEPTEMBER 2006

**equivalent schematic**

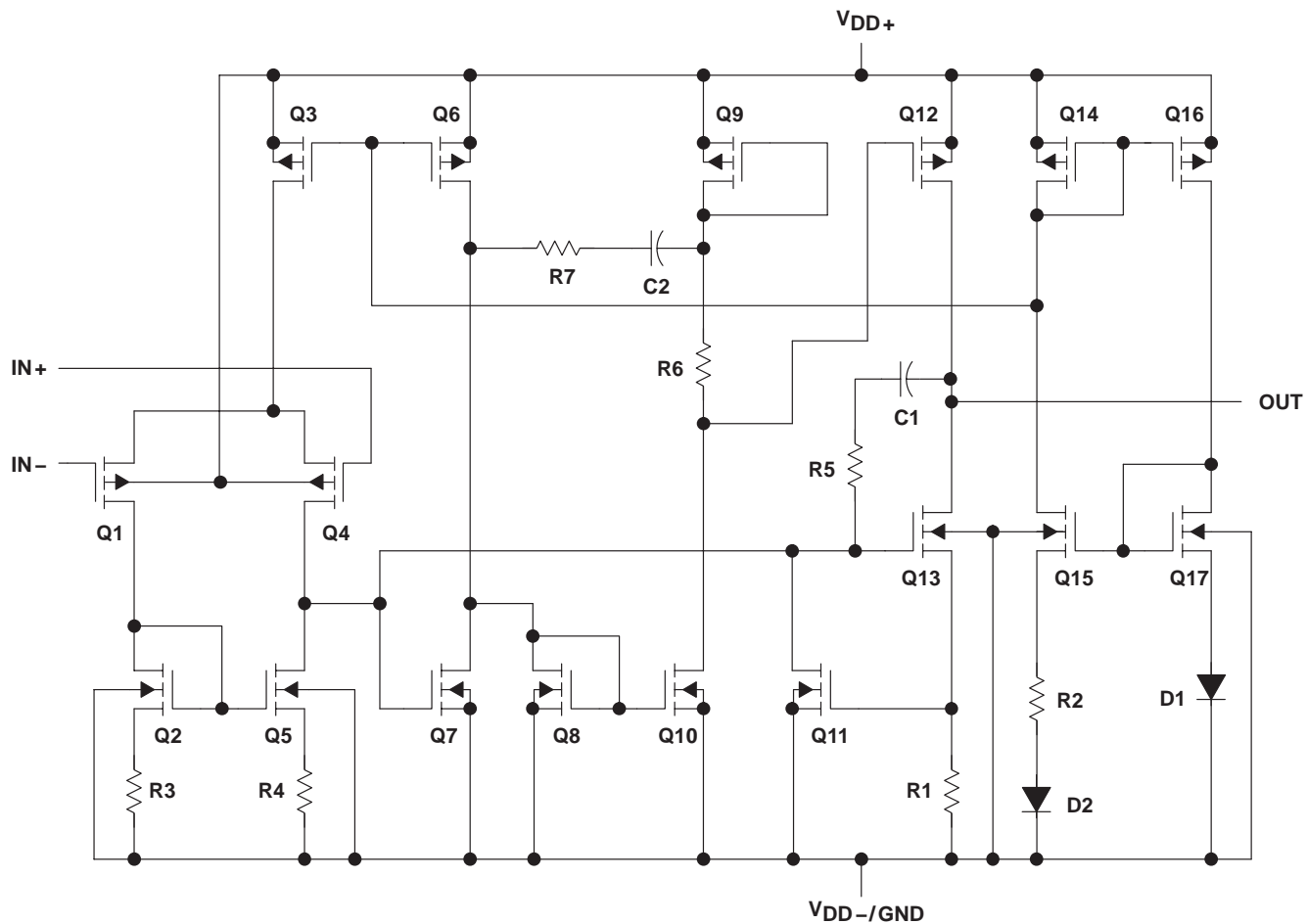

COMPONENT COUNT†	
Transistors	23
Diodes	6
Resistors	11
Capacitors	2

† Includes both amplifiers and all ESD, bias, and trim circuitry

**TLV2211, TLV2211Y**  
**Advanced LinCMOS™ RAIL-TO-RAIL**  
**MICROPOWER SINGLE OPERATIONAL AMPLIFIERS**

SLOS156E – MAY 1996 – REVISED SEPTEMBER 2006

**absolute maximum ratings over operating free-air temperature range (unless otherwise noted)†**

Supply voltage, $V_{DD}$ (see Note 1)	12 V
Differential input voltage, $V_{ID}$ (see Note 2)	$\pm V_{DD}$
Input voltage range, $V_I$ (any input, see Note 1)	-0.3 V to $V_{DD}$
Input current, $I_I$ (each input)	$\pm 5$ mA
Output current, $I_O$	$\pm 50$ mA
Total current into $V_{DD+}$	$\pm 50$ mA
Total current out of $V_{DD-}$	$\pm 50$ mA
Duration of short-circuit current (at or below) 25°C (see Note 3)	unlimited
Continuous total power dissipation	See Dissipation Rating Table
Operating free-air temperature range, $T_A$ : TLV2211C	0°C to 70°C
TLV2211I	-40°C to 85°C
Storage temperature range, $T_{stg}$	-65°C to 150°C
Lead temperature 1,6 mm (1/16 inch) from case for 10 seconds: DBV package	260°C

† Stresses beyond those listed under “absolute maximum ratings” may cause permanent damage to the device. These are stress ratings only, and functional operation of the device at these or any other conditions beyond those indicated under “recommended operating conditions” is not implied. Exposure to absolute-maximum-rated conditions for extended periods may affect device reliability.

- NOTES:
1. All voltage values, except differential voltages, are with respect to  $V_{DD-}$ .
  2. Differential voltages are at the noninverting input with respect to the inverting input. Excessive current flows when input is brought below  $V_{DD-} - 0.3$  V.
  3. The output may be shorted to either supply. Temperature and/or supply voltages must be limited to ensure that the maximum dissipation rating is not exceeded.

**DISSIPATION RATING TABLE**

PACKAGE	$T_A \leq 25^\circ\text{C}$ POWER RATING	DERATING FACTOR ABOVE $T_A = 25^\circ\text{C}$	$T_A = 70^\circ\text{C}$ POWER RATING	$T_A = 85^\circ\text{C}$ POWER RATING
DBV	150 mW	1.2 mW/°C	96 mW	78 mW

**recommended operating conditions**

	TLV2211C		TLV2211I		UNIT
	MIN	MAX	MIN	MAX	
Supply voltage, $V_{DD}$ (see Note 1)	2.7	10	2.7	10	V
Input voltage range, $V_I$	$V_{DD-}$	$V_{DD+} - 1.3$	$V_{DD-}$	$V_{DD+} - 1.3$	V
Common-mode input voltage, $V_{IC}$	$V_{DD-}$	$V_{DD+} - 1.3$	$V_{DD-}$	$V_{DD+} - 1.3$	V
Operating free-air temperature, $T_A$	0	70	-40	85	°C

NOTE 1: All voltage values, except differential voltages, are with respect to  $V_{DD-}$ .



# TLV2211, TLV2211Y

## Advanced LinCMOS™ RAIL-TO-RAIL

### MICROPOWER SINGLE OPERATIONAL AMPLIFIERS

SLOS156E – MAY 1996 – REVISED SEPTEMBER 2006

electrical characteristics at specified free-air temperature,  $V_{DD} = 3\text{ V}$  (unless otherwise noted)

PARAMETER	TEST CONDITIONS	$T_A$ †	TLV2211C			TLV2211I			UNIT		
			MIN	TYP	MAX	MIN	TYP	MAX			
$V_{IO}$ Input offset voltage	$V_{DD\pm} = \pm 1.5\text{ V}$ , $V_O = 0$ , $V_{IC} = 0$ , $R_S = 50\ \Omega$	Full range	0.47		3	0.47		3	mV		
$\alpha_{VIO}$ Temperature coefficient of input offset voltage			1		1		$\mu\text{V}/^\circ\text{C}$				
Input offset voltage long-term drift (see Note 4)			25°C		0.003		0.003		$\mu\text{V}/\text{mo}$		
$I_{IO}$ Input offset current			Full range		0.5		60	0.5		60	pA
$I_{IB}$ Input bias current			Full range		1		60	1		60	pA
$V_{ICR}$ Common-mode input voltage range	$ V_{IO}  \leq 5\text{ mV}$ , $R_S = 50\ \Omega$	25°C	0 to 2	-0.3 to 2.2		0 to 2	-0.3 to 2.2		V		
		Full range	0 to 1.7		0 to 1.7						
$V_{OH}$ High-level output voltage	$I_{OH} = -100\ \mu\text{A}$ $I_{OH} = -250\ \mu\text{A}$	25°C	2.94		2.94				V		
		25°C	2.85		2.85						
		Full range	2.5		2.5						
$V_{OL}$ Low-level output voltage	$V_{IC} = 1.5\text{ V}$ , $I_{OL} = 50\ \mu\text{A}$ $V_{IC} = 1.5\text{ V}$ , $I_{OL} = 500\ \mu\text{A}$	25°C	15		15				mV		
		25°C	150		150						
		Full range	500		500						
$A_{VD}$ Large-signal differential voltage amplification	$V_{IC} = 1.5\text{ V}$ , $V_O = 1\text{ V to }2\text{ V}$	25°C	3		7	3		7	V/mV		
			Full range	1		1					
		25°C	600		600						
$r_{i(d)}$ Differential input resistance		25°C	10 <sup>12</sup>		10 <sup>12</sup>				$\Omega$		
$r_{i(c)}$ Common-mode input resistance		25°C	10 <sup>12</sup>		10 <sup>12</sup>				$\Omega$		
$C_{i(c)}$ Common-mode input capacitance	$f = 10\text{ kHz}$	25°C	5		5				pF		
$z_o$ Closed-loop output impedance	$f = 7\text{ kHz}$ , $A_V = 1$	25°C	200		200				$\Omega$		
CMRR Common-mode rejection ratio	$V_{IC} = 0\text{ to }1.7\text{ V}$ , $R_S = 50\ \Omega$ , $V_O = 1.5\text{ V}$	25°C	65	83		65	83		dB		
		Full range	60		60						
$k_{SVR}$ Supply voltage rejection ratio ( $\Delta V_{DD} / \Delta V_{IO}$ )	$V_{DD} = 2.7\text{ V to }8\text{ V}$ , No load, $V_{IC} = V_{DD}/2$	25°C	80	95		80	95		dB		
		Full range	80		80						
$I_{DD}$ Supply current	$V_O = 1.5\text{ V}$ , No load	25°C	11	25		11	25		$\mu\text{A}$		
		Full range	30		30						

† Full range for the TLV2211C is 0°C to 70°C. Full range for the TLV2211I is -40°C to 85°C.

‡ Referenced to 1.5 V

NOTE 4: Typical values are based on the input offset voltage shift observed through 500 hours of operating life test at  $T_A = 150^\circ\text{C}$  extrapolated to  $T_A = 25^\circ\text{C}$  using the Arrhenius equation and assuming an activation energy of 0.96 eV.



**TLV2211, TLV2211Y**  
**Advanced LinCMOS™ RAIL-TO-RAIL**  
**MICROPOWER SINGLE OPERATIONAL AMPLIFIERS**

SLOS156E – MAY 1996 – REVISED SEPTEMBER 2006

operating characteristics at specified free-air temperature,  $V_{DD} = 3\text{ V}$  (unless otherwise noted)

PARAMETER	TEST CONDITIONS	$T_A$ †	TLV2211C			TLV2211I			UNIT
			MIN	TYP	MAX	MIN	TYP	MAX	
SR	Slew rate at unity gain $V_O = 1.1\text{ V to }1.9\text{ V}, R_L = 10\text{ k}\Omega^\ddagger,$ $C_L = 100\text{ pF}^\ddagger$	25°C	0.01	0.025		0.01	0.025		V/ $\mu$ s
		Full range	0.005			0.005			
$V_n$	Equivalent input noise voltage $f = 10\text{ Hz}$ $f = 1\text{ kHz}$	25°C	80			80			nV/ $\sqrt{\text{Hz}}$
		25°C	22			22			
$V_{N(PP)}$	Peak-to-peak equivalent input noise voltage $f = 0.1\text{ Hz to }1\text{ Hz}$ $f = 0.1\text{ Hz to }10\text{ Hz}$	25°C	660			660			nV
		25°C	880			880			
$I_n$	Equivalent input noise current	25°C	0.6			0.6			fA/ $\sqrt{\text{Hz}}$
	Gain-bandwidth product $f = 10\text{ kHz}, R_L = 10\text{ k}\Omega^\ddagger,$ $C_L = 100\text{ pF}^\ddagger$	25°C	56			56			kHz
BOM	Maximum output-swing bandwidth $V_{O(PP)} = 1\text{ V}, R_L = 10\text{ k}\Omega^\ddagger,$ $A_V = 1, C_L = 100\text{ pF}^\ddagger$	25°C	7			7			kHz
$\phi_m$	Phase margin at unity gain $R_L = 10\text{ k}\Omega^\ddagger, C_L = 100\text{ pF}^\ddagger$	25°C	56°			56°			
		25°C	20			20			
	Gain margin	25°C	20			20			dB

† Full range is  $-40^\circ\text{C}$  to  $85^\circ\text{C}$ .

‡ Referenced to 1.5 V

# TLV2211, TLV2211Y

## Advanced LinCMOS™ RAIL-TO-RAIL

### MICROPOWER SINGLE OPERATIONAL AMPLIFIERS

SLOS156E – MAY 1996 – REVISED SEPTEMBER 2006

electrical characteristics at specified free-air temperature,  $V_{DD} = 5\text{ V}$  (unless otherwise noted)

PARAMETER	TEST CONDITIONS	$T_A$ †	TLV2211C			TLV2211I			UNIT
			MIN	TYP	MAX	MIN	TYP	MAX	
$V_{IO}$ Input offset voltage	$V_{DD\pm} = \pm 2.5\text{ V}$ , $V_O = 0$ , $V_{IC} = 0$ , $R_S = 50\ \Omega$	Full range	0.45	3		0.45	3	mV	
$\alpha_{V_{IO}}$ Temperature coefficient of input offset voltage			0.5		0.5		$\mu\text{V}/^\circ\text{C}$		
Input offset voltage long-term drift (see Note 5)		25°C	0.003		0.003		$\mu\text{V}/\text{mo}$		
$I_{IO}$ Input offset current		25°C	0.5	60	0.5	60	pA		
		Full range		150		150			
$I_{IB}$ Input bias current		25°C	1	60	1	60	pA		
	Full range		150		150				
$V_{ICR}$ Common-mode input voltage range	$ V_{IO}  \leq 5\text{ mV}$ $R_S = 50\ \Omega$	25°C	0 to 4	-0.3 to 4.2	0 to 4	-0.3 to 4.2	V		
		Full range	0 to 3.5		0 to 3.5				
$V_{OH}$ High-level output voltage	$I_{OH} = -100\ \mu\text{A}$ $I_{OH} = -250\ \mu\text{A}$	25°C	4.95		4.95	V			
		25°C	4.875		4.875				
		Full range	4.5		4.5				
$V_{OL}$ Low-level output voltage	$V_{IC} = 2.5\text{ V}$ , $I_{OL} = 50\ \mu\text{A}$ $V_{IC} = 2.5\text{ V}$ , $I_{OL} = 500\ \mu\text{A}$	25°C	12		12	mV			
		25°C	120		120				
		Full range		500			500		
$A_{VD}$ Large-signal differential voltage amplification	$V_{IC} = 2.5\text{ V}$ , $V_O = 1\text{ V to }4\text{ V}$	25°C	$R_L = 10\text{ k}\Omega$ ‡		6	12	6	12	V/mV
			$R_L = 1\text{ M}\Omega$ ‡		3		3		
		25°C	$R_L = 1\text{ M}\Omega$ ‡		800		800		
$r_{i(d)}$ Differential input resistance		25°C	$10^{12}$			$10^{12}$		$\Omega$	
$r_{i(c)}$ Common-mode input resistance		25°C	$10^{12}$			$10^{12}$		$\Omega$	
$C_{i(c)}$ Common-mode input capacitance	$f = 10\text{ kHz}$ ,	25°C	5			5		pF	
$z_o$ Closed-loop output impedance	$f = 7\text{ kHz}$ , $A_V = 1$	25°C	200			200		$\Omega$	
CMRR Common-mode rejection ratio	$V_{IC} = 0\text{ to }2.7\text{ V}$ , $R_S = 50\ \Omega$ , $V_O = 2.5\text{ V}$	25°C	70	83	70	83	dB		
		Full range	70		70				
$k_{SVR}$ Supply voltage rejection ratio ( $\Delta V_{DD} / \Delta V_{IO}$ )	$V_{DD} = 4.4\text{ V to }8\text{ V}$ , No load, $V_{IC} = V_{DD}/2$	25°C	80	95	80	95	dB		
		Full range	80		80				
$I_{DD}$ Supply current	$V_O = 2.5\text{ V}$ , No load	25°C	13	25	13	25	$\mu\text{A}$		
		Full range		30		30			

† Full range for the TLV2211C is 0°C to 70°C. Full range for the TLV2211I is -40°C to 85°C.

‡ Referenced to 1.5 V

NOTE 5: Typical values are based on the input offset voltage shift observed through 500 hours of operating life test at  $T_A = 150^\circ\text{C}$  extrapolated to  $T_A = 25^\circ\text{C}$  using the Arrhenius equation and assuming an activation energy of 0.96 eV.





**TLV2211, TLV2211Y**  
**Advanced LinCMOS™ RAIL-TO-RAIL**  
**MICROPOWER SINGLE OPERATIONAL AMPLIFIERS**

SLOS156E – MAY 1996 – REVISED SEPTEMBER 2006

**operating characteristics at specified free-air temperature,  $V_{DD} = 5\text{ V}$  (unless otherwise noted)**

PARAMETER	TEST CONDITIONS	$T_A$ †	TLV2211C			TLV2211I			UNIT
			MIN	TYP	MAX	MIN	TYP	MAX	
SR	Slew rate at unity gain $V_O = 1.5\text{ V to }3.5\text{ V}, R_L = 10\text{ k}\Omega^\ddagger, C_L = 100\text{ pF}^\ddagger$	25°C	0.01	0.025		0.01	0.025		V/ $\mu\text{s}$
		Full range	0.005			0.005			
$V_n$	Equivalent input noise voltage	f = 10 Hz	72			72			nV/ $\sqrt{\text{Hz}}$
		f = 1 kHz	21			21			
$V_{N(PP)}$	Peak-to-peak equivalent input noise voltage	f = 0.1 Hz to 1 Hz	600			600			nV
		f = 0.1 Hz to 10 Hz	800			800			
$I_n$	Equivalent input noise current	25°C	0.6			0.6			fA/ $\sqrt{\text{Hz}}$
	Gain-bandwidth product	f = 10 kHz, $R_L = 10\text{ k}\Omega^\ddagger, C_L = 100\text{ pF}^\ddagger$	65			65			kHz
BOM	Maximum output-swing bandwidth	$V_{O(PP)} = 2\text{ V}, R_L = 10\text{ k}\Omega^\ddagger, A_V = 1, C_L = 100\text{ pF}^\ddagger$	7			7			kHz
$\phi_m$	Phase margin at unity gain	$R_L = 10\text{ k}\Omega^\ddagger, C_L = 100\text{ pF}^\ddagger$	56°			56°			
		Gain margin	22			22			

† Full range is  $-40^\circ\text{C}$  to  $85^\circ\text{C}$ .

‡ Referenced to 1.5 V

**electrical characteristics at  $V_{DD} = 3\text{ V}, T_A = 25^\circ\text{C}$  (unless otherwise noted)**

PARAMETER	TEST CONDITIONS	TLV2211Y			UNIT
		MIN	TYP	MAX	
$V_{IO}$	Input offset voltage	0.47			mV
$I_{IO}$	Input offset current	0.5			pA
$I_{IB}$	Input bias current	1			
$V_{ICR}$	Common-mode input voltage range	-0.3 to 2.2			V
$V_{OH}$	High-level output voltage	$I_{OH} = -100\text{ }\mu\text{A}$			V
		$I_{OH} = -200\text{ }\mu\text{A}$			
$V_{OL}$	Low-level output voltage	$V_{IC} = 0, I_{OL} = 50\text{ }\mu\text{A}$			mV
		$V_{IC} = 0, I_{OL} = 500\text{ }\mu\text{A}$			
$A_{VD}$	Large-signal differential voltage amplification	$V_{IC} = 1.5\text{ V}, V_O = 1\text{ V to }2\text{ V}$	$R_L = 10\text{ k}\Omega^\ddagger$		V/mV
			$R_L = 1\text{ M}\Omega^\ddagger$		
$r_{i(d)}$	Differential input resistance	$10^{12}$			$\Omega$
$r_{i(c)}$	Common-mode input resistance	$10^{12}$			$\Omega$
$c_{i(c)}$	Common-mode input capacitance	f = 10 kHz			pF
$z_o$	Closed-loop output impedance	f = 7 kHz, $A_V = 1$			$\Omega$
CMRR	Common-mode rejection ratio	$V_{IC} = 0\text{ to }1.7\text{ V}, V_O = 1.5\text{ V}, R_S = 50\text{ }\Omega$			dB
$k_{SVR}$	Supply voltage rejection ratio ( $\Delta V_{DD}/\Delta V_{IO}$ )	$V_{DD} = 2.7\text{ V to }8\text{ V}, V_{IC} = V_{DD}/2, \text{ No load}$			dB
$I_{DD}$	Supply current	$V_O = 1.5\text{ V}, \text{ No load}$			$\mu\text{A}$

† Referenced to 1.5 V



**TLV2211, TLV2211Y**  
**Advanced LinCMOS™ RAIL-TO-RAIL**  
**MICROPOWER SINGLE OPERATIONAL AMPLIFIERS**

SLOS156E – MAY 1996 – REVISED SEPTEMBER 2006

electrical characteristics at  $V_{DD} = 5\text{ V}$ ,  $T_A = 25^\circ\text{C}$  (unless otherwise noted)

PARAMETER	TEST CONDITIONS	TLV2211Y			UNIT
		MIN	TYP	MAX	
$V_{IO}$ Input offset voltage	$V_{DD} \pm \pm 2.5\text{ V}$ , $R_S = 50\ \Omega$ $V_{IC} = 0$ , $V_O = 0$ ,	0.45			mV
$I_{IO}$ Input offset current		0.5	60		pA
$I_{IB}$ Input bias current		1	60		pA
$V_{ICR}$ Common-mode input voltage range	$ V_{IO}  \leq 5\text{ mV}$ , $R_S = 50\ \Omega$	-0.3 to 4.2			V
$V_{OH}$ High-level output voltage	$I_{OH} = -100\ \mu\text{A}$	4.95			V
	$I_{OH} = -250\ \mu\text{A}$	4.875			
$V_{OL}$ Low-level output voltage	$V_{IC} = 2.5\text{ V}$ , $I_{OL} = 50\ \mu\text{A}$	12			mV
	$V_{IC} = 2.5\text{ V}$ , $I_{OL} = 500\ \mu\text{A}$	120			
$A_{VD}$ Large-signal differential voltage amplification	$V_{IC} = 2.5\text{ V}$ , $V_O = 1\text{ V to }4\text{ V}$	$R_L = 10\text{ k}\Omega^\dagger$	12		V/mV
		$R_L = 1\text{ M}\Omega^\dagger$	800		
$r_{i(d)}$ Differential input resistance		$10^{12}$			$\Omega$
$r_{i(c)}$ Common-mode input resistance		$10^{12}$			$\Omega$
$c_{i(c)}$ Common-mode input capacitance	$f = 10\text{ kHz}$	5			pF
$z_o$ Closed-loop output impedance	$f = 7\text{ kHz}$ , $A_V = 1$	200			$\Omega$
CMRR Common-mode rejection ratio	$V_{IC} = 0\text{ to }2.7\text{ V}$ , $V_O = 2.5\text{ V}$ , $R_S = 50\ \Omega$	83			dB
$k_{SVR}$ Supply voltage rejection ratio ( $\Delta V_{DD}/\Delta V_{IO}$ )	$V_{DD} = 4.4\text{ V to }8\text{ V}$ , $V_{IC} = V_{DD}/2$ , No load	95			dB
$I_{DD}$ Supply current	$V_O = 2.5\text{ V}$ , No load	13			$\mu\text{A}$

$^\dagger$  Referenced to 1.5 V

## TYPICAL CHARACTERISTICS

**Table of Graphs**

		FIGURE
$V_{IO}$	Input offset voltage	Distribution vs Common-mode input voltage
		3, 4 5, 6
$\alpha_{VIO}$	Input offset voltage temperature coefficient	Distribution
		7, 8
$I_{IB}/I_{IO}$	Input bias and input offset currents	vs Free-air temperature
		9
$V_I$	Input voltage	vs Supply voltage vs Free-air temperature
		10 11
$V_{OH}$	High-level output voltage	vs High-level output current
		12, 15
$V_{OL}$	Low-level output voltage	vs Low-level output current
		13, 14, 16
$V_{O(PP)}$	Maximum peak-to-peak output voltage	vs Frequency
		17
$I_{OS}$	Short-circuit output current	vs Supply voltage vs Free-air temperature
		18 19
$V_O$	Output voltage	vs Differential input voltage
		20, 21
$A_{VD}$	Differential voltage amplification	vs Load resistance vs Frequency vs Free-air temperature
		22 23, 24 25, 26
$z_o$	Output impedance	vs Frequency
		27, 28
CMRR	Common-mode rejection ratio	vs Frequency vs Free-air temperature
		29 30
$k_{SVR}$	Supply-voltage rejection ratio	vs Frequency vs Free-air temperature
		31, 32 33
$I_{DD}$	Supply current	vs Supply voltage
		34
SR	Slew rate	vs Load capacitance vs Free-air temperature
		35 36
$V_O$	Large-signal pulse response	vs Time
		37, 38, 39, 40
$V_O$	Small-signal pulse response	vs Time
		41, 42, 43, 44
$V_n$	Equivalent input noise voltage	vs Frequency
		45, 46
	Noise voltage (referred to input)	Over a 10-second period
		47
THD + N	Total harmonic distortion plus noise	vs Frequency
		48
	Gain-bandwidth product	vs Free-air temperature vs Supply voltage
		49 50
$\phi_m$	Phase margin	vs Frequency vs Load capacitance
		23, 24 51
	Gain margin	vs Load capacitance
		52
$B_1$	Unity-gain bandwidth	vs Load capacitance
		53

**TYPICAL CHARACTERISTICS**

**DISTRIBUTION OF TLV2211  
 INPUT OFFSET VOLTAGE**

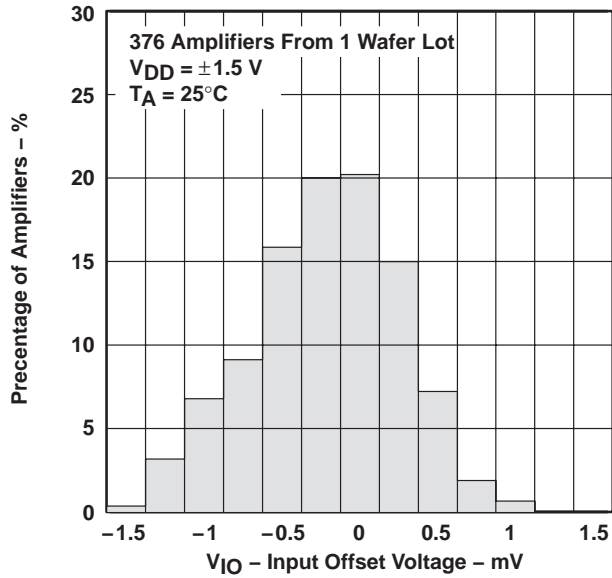

**Figure 3**

**DISTRIBUTION OF TLV2211  
 INPUT OFFSET VOLTAGE**

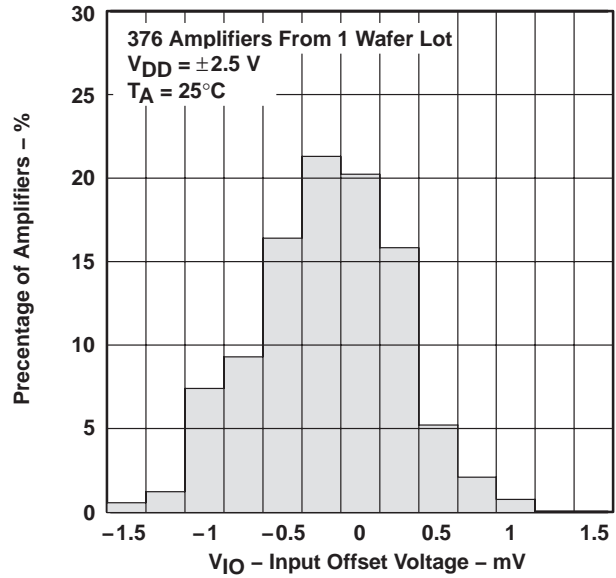

**Figure 4**

**INPUT OFFSET VOLTAGE†  
 vs  
 COMMON-MODE INPUT VOLTAGE**

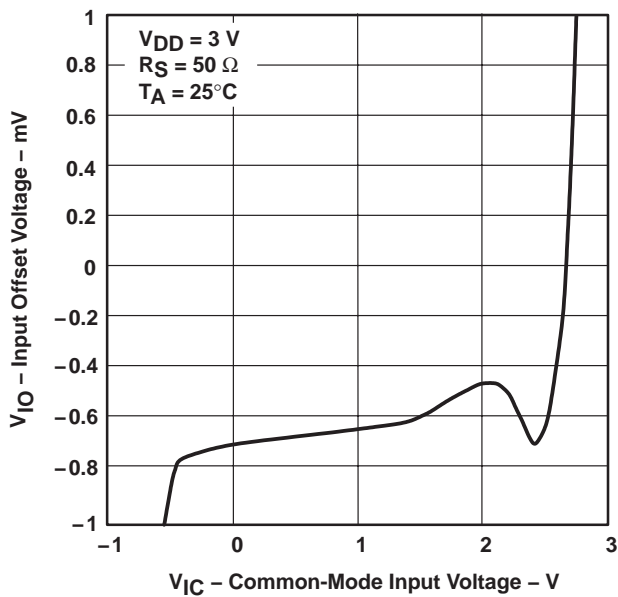

**Figure 5**

**INPUT OFFSET VOLTAGE†  
 vs  
 COMMON-MODE INPUT VOLTAGE**

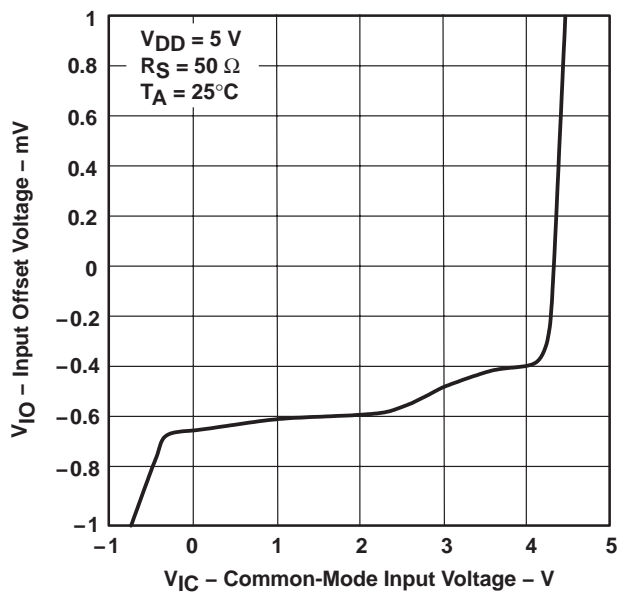

**Figure 6**

† For all curves where  $V_{DD} = 5\text{ V}$ , all loads are referenced to 2.5 V. For all curves where  $V_{DD} = 3\text{ V}$ , all loads are referenced to 1.5 V.

**TYPICAL CHARACTERISTICS**

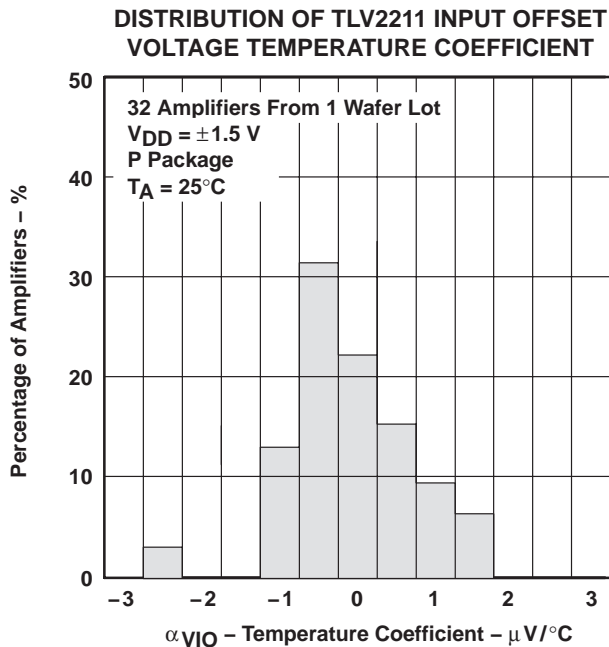

**Figure 7**

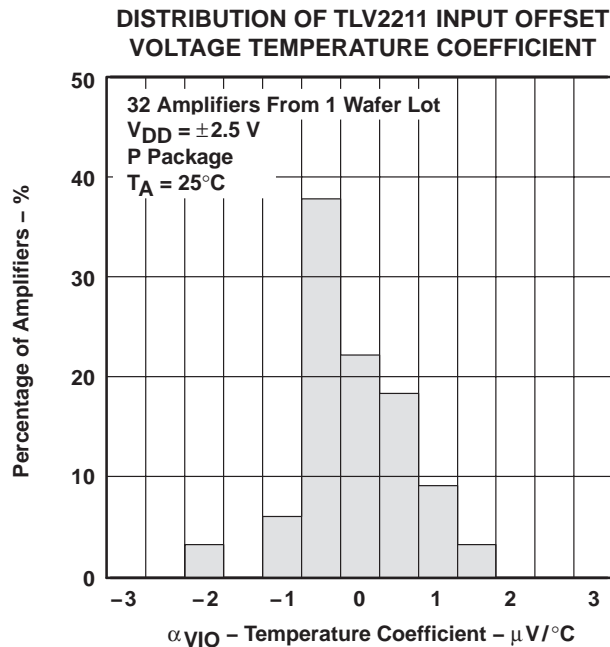

**Figure 8**

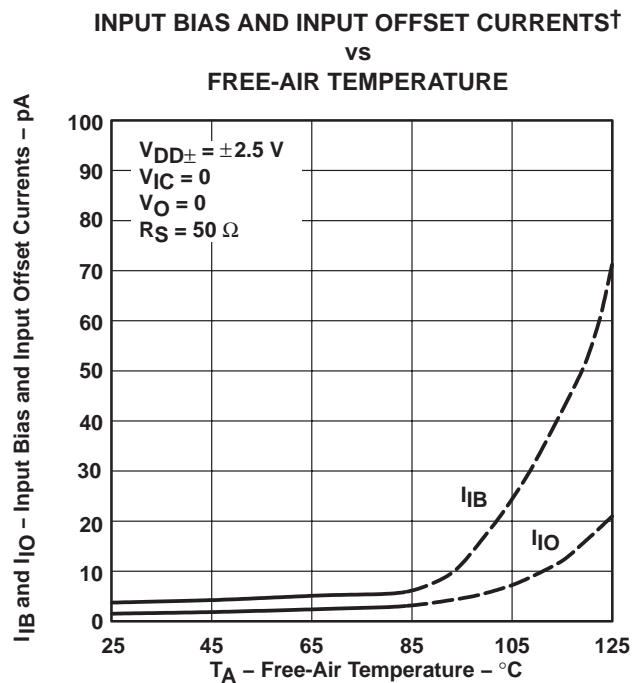

**Figure 9**

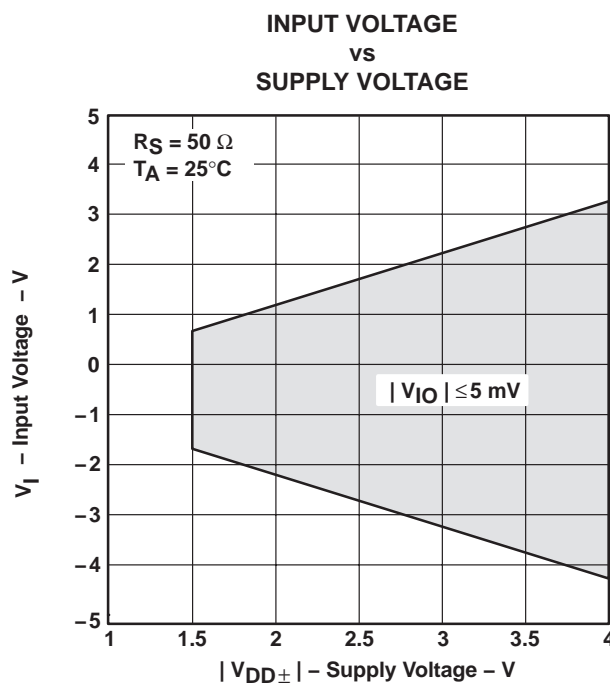

**Figure 10**

† Data at high and low temperatures are applicable only within the rated operating free-air temperature ranges of the various devices.

**TYPICAL CHARACTERISTICS**

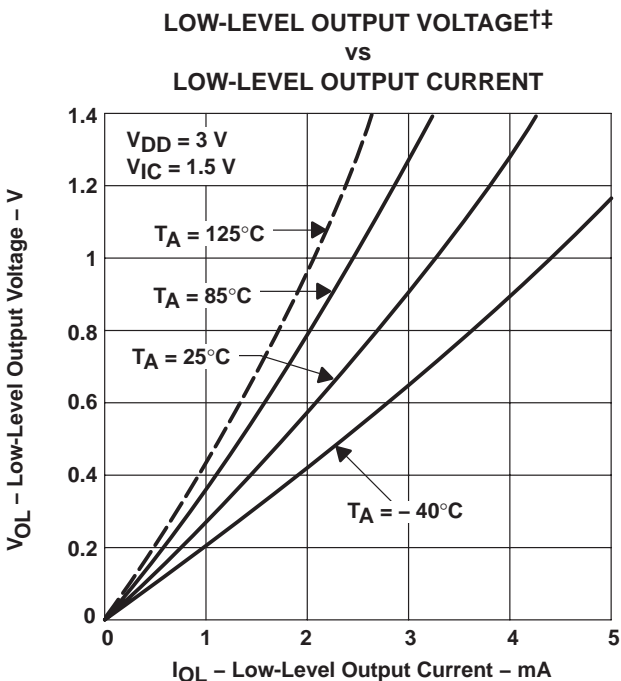
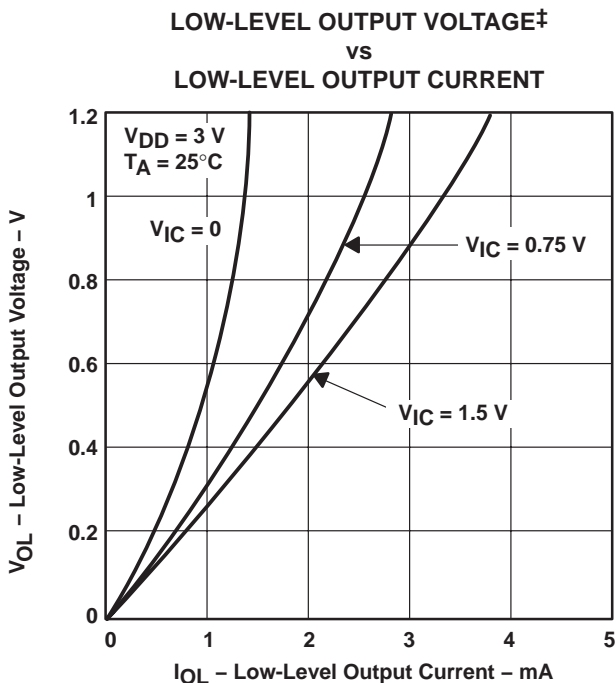
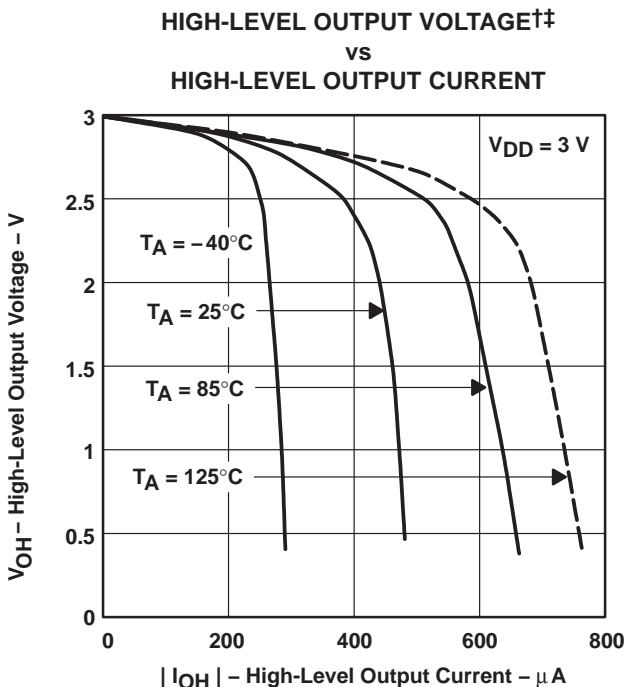
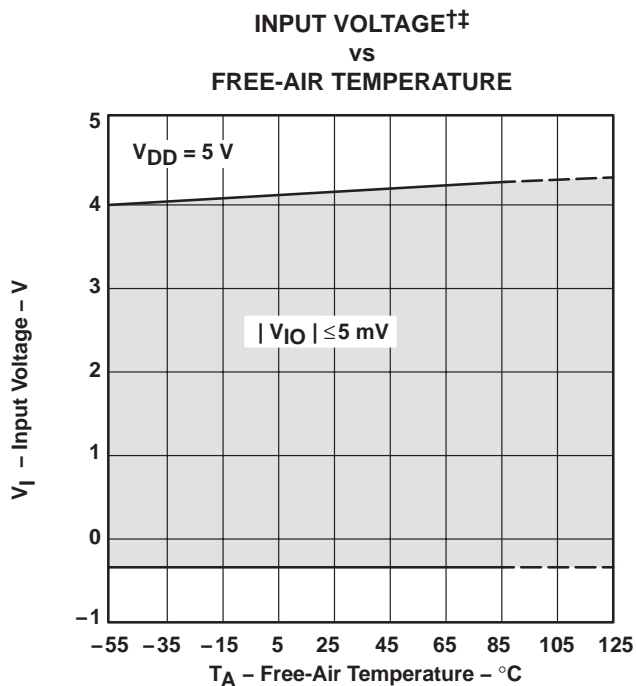

† Data at high and low temperatures are applicable only within the rated operating free-air temperature ranges of the various devices.  
 ‡ For all curves where  $V_{DD} = 5\text{ V}$ , all loads are referenced to 2.5 V. For all curves where  $V_{DD} = 3\text{ V}$ , all loads are referenced to 1.5 V.

**TYPICAL CHARACTERISTICS**

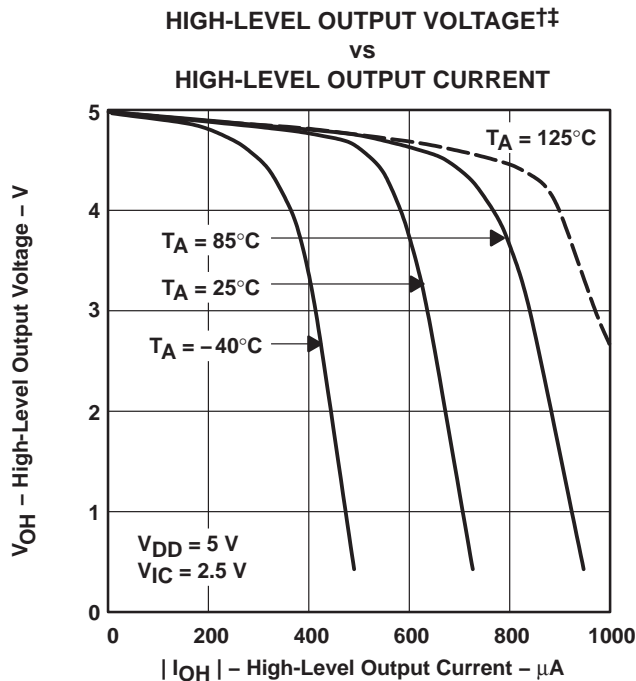

Figure 15

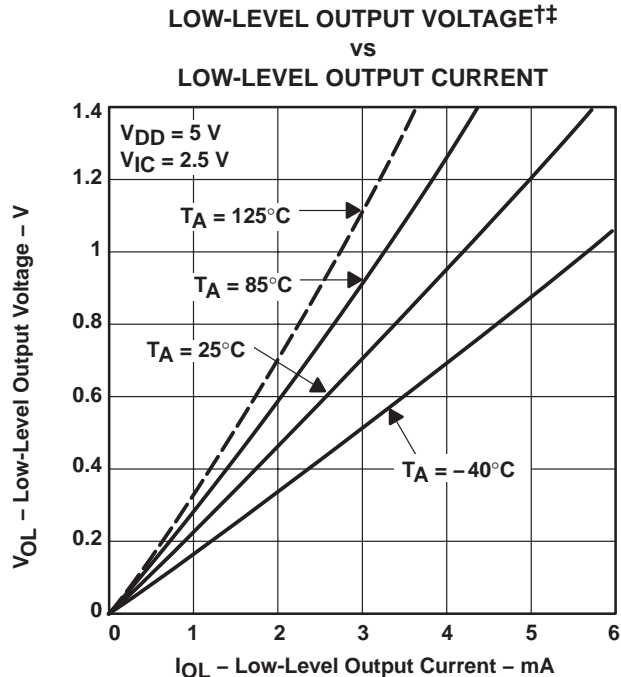

Figure 16

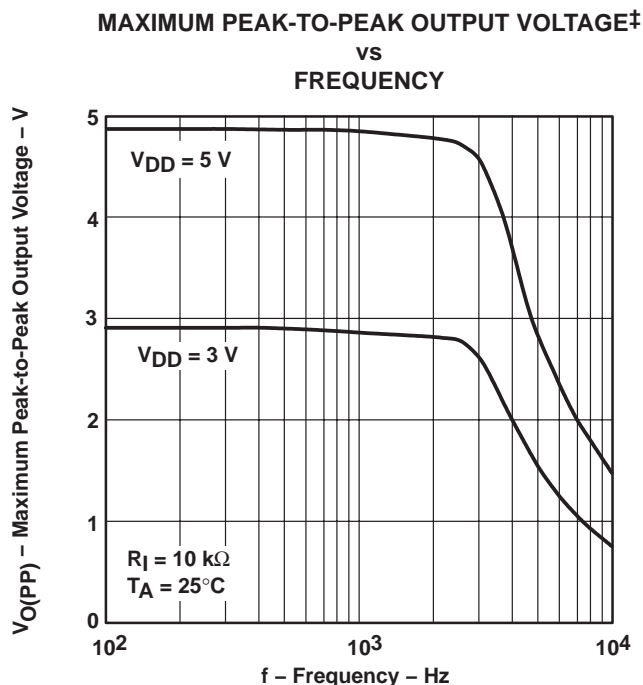

Figure 17

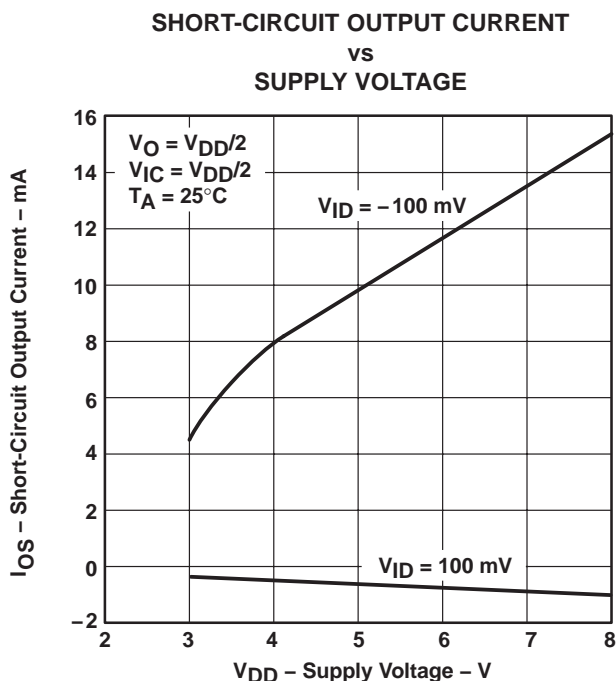

Figure 18

† Data at high and low temperatures are applicable only within the rated operating free-air temperature ranges of the various devices.  
 ‡ For all curves where  $V_{DD} = 5 V$ , all loads are referenced to 2.5 V. For all curves where  $V_{DD} = 3 V$ , all loads are referenced to 1.5 V.

**TLV2211, TLV2211Y**  
**Advanced LinCMOS™ RAIL-TO-RAIL**  
**MICROPOWER SINGLE OPERATIONAL AMPLIFIERS**

SLOS156E – MAY 1996 – REVISED SEPTEMBER 2006

**TYPICAL CHARACTERISTICS**

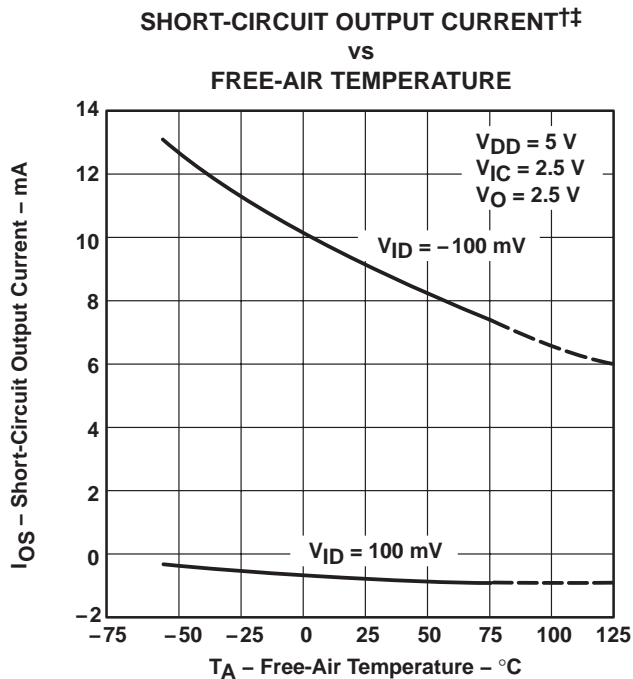

**Figure 19**

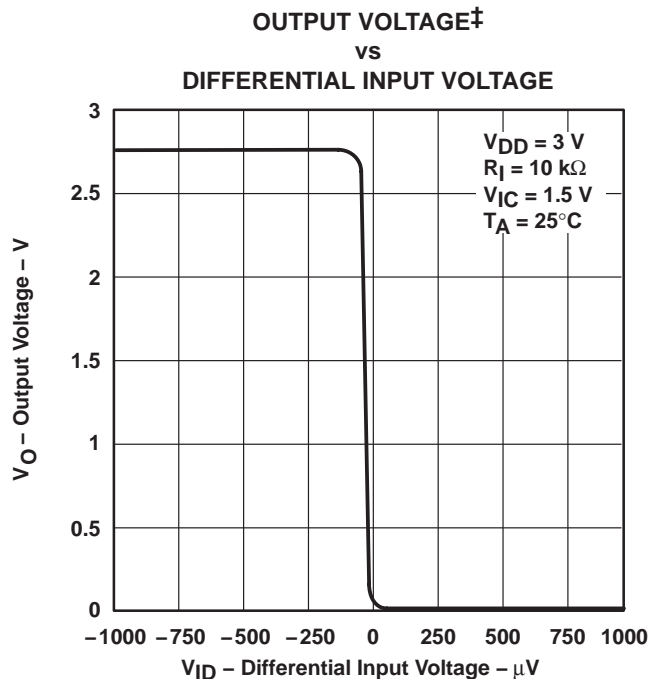

**Figure 20**

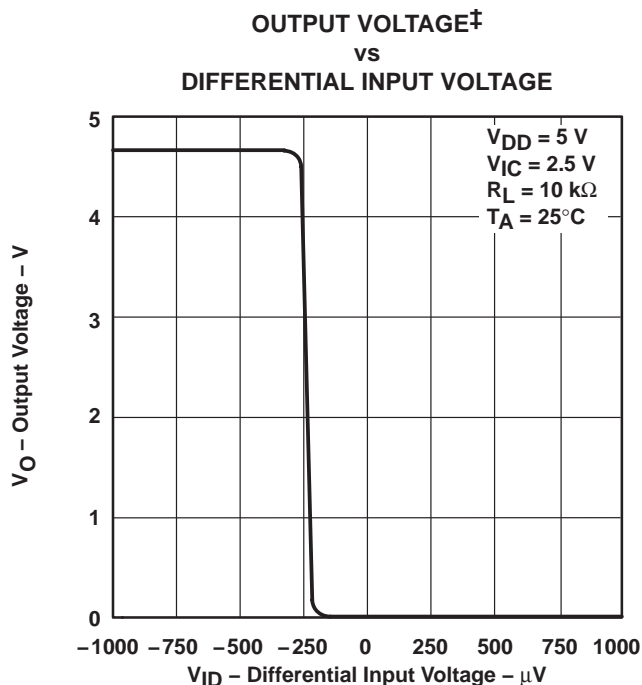

**Figure 21**

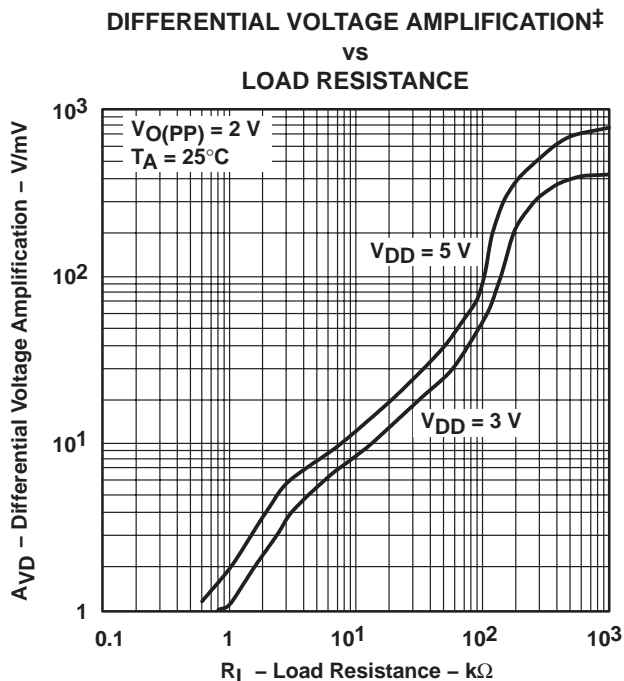

**Figure 22**

† Data at high and low temperatures are applicable only within the rated operating free-air temperature ranges of the various devices.

‡ For all curves where  $V_{DD} = 5\text{ V}$ , all loads are referenced to 2.5 V. For all curves where  $V_{DD} = 3\text{ V}$ , all loads are referenced to 1.5 V.





**TYPICAL CHARACTERISTICS**

**LARGE-SIGNAL DIFFERENTIAL VOLTAGE  
AMPLIFICATION AND PHASE MARGIN†**

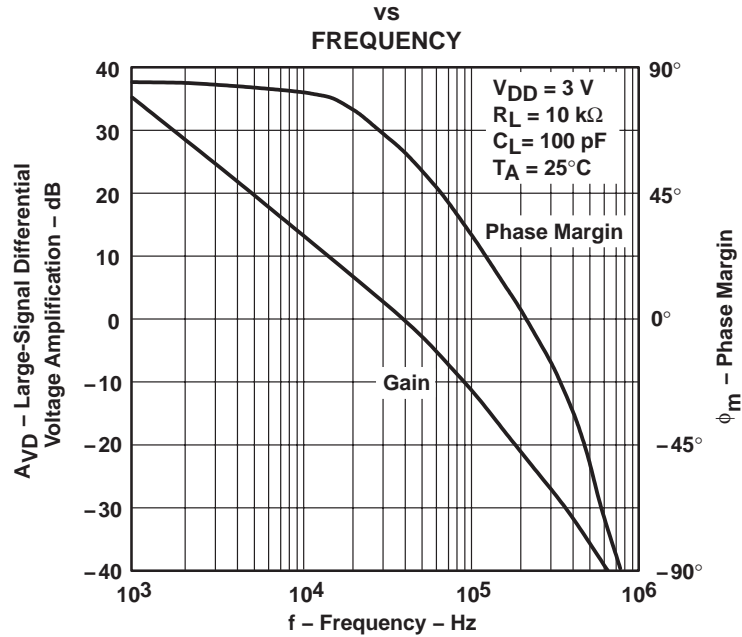

**Figure 23**

**LARGE-SIGNAL DIFFERENTIAL VOLTAGE  
AMPLIFICATION AND PHASE MARGIN†**

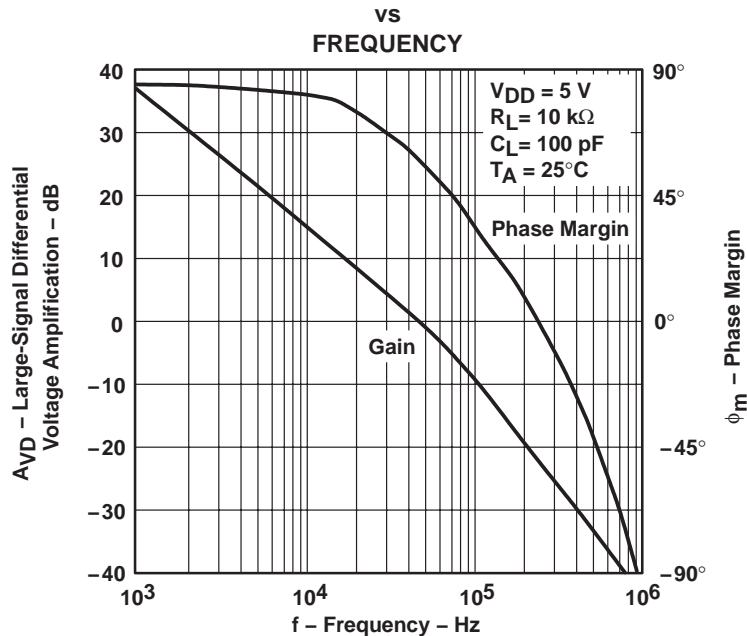
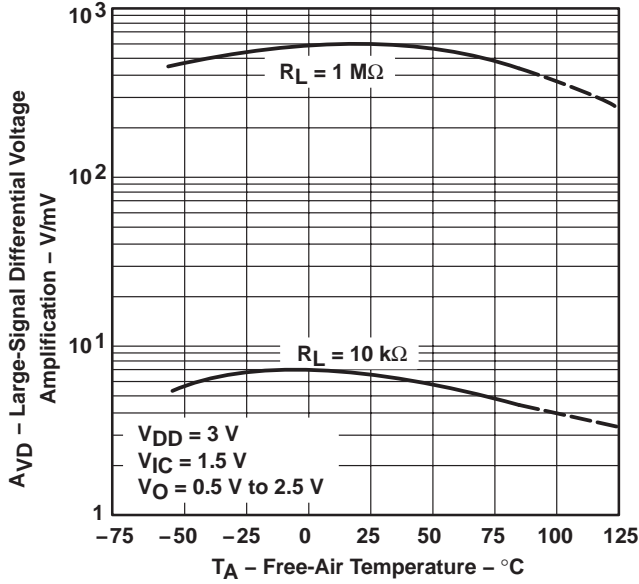

**Figure 24**

† For all curves where  $V_{DD} = 5\text{ V}$ , all loads are referenced to 2.5 V. For all curves where  $V_{DD} = 3\text{ V}$ , all loads are referenced to 1.5 V.

**TYPICAL CHARACTERISTICS**

**LARGE-SIGNAL DIFFERENTIAL VOLTAGE AMPLIFICATION†‡**  
 vs  
**FREE-AIR TEMPERATURE**



**Figure 25**

**LARGE-SIGNAL DIFFERENTIAL VOLTAGE AMPLIFICATION†‡**  
 vs  
**FREE-AIR TEMPERATURE**

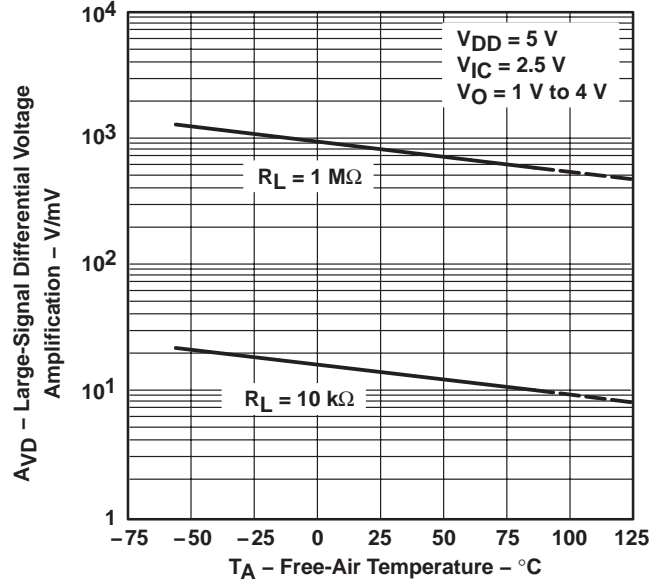

**Figure 26**

**OUTPUT IMPEDANCE‡**  
 vs  
**FREQUENCY**

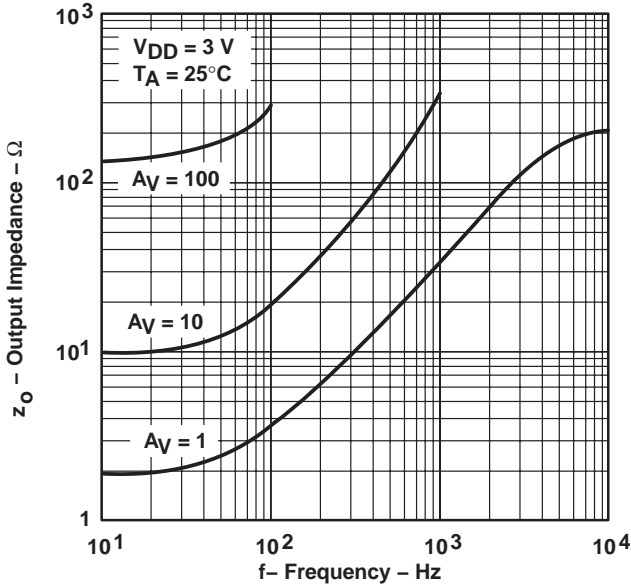

**Figure 27**

**OUTPUT IMPEDANCE‡**  
 vs  
**FREQUENCY**

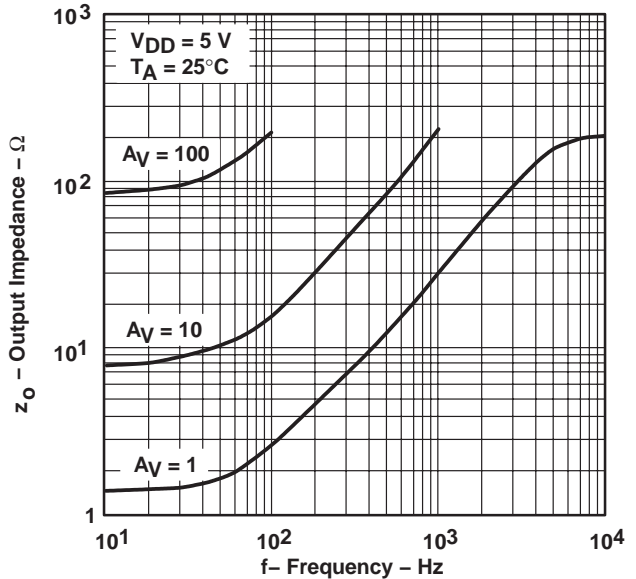

**Figure 28**

† Data at high and low temperatures are applicable only within the rated operating free-air temperature ranges of the various devices.  
 ‡ For all curves where  $V_{DD} = 5\text{ V}$ , all loads are referenced to 2.5 V. For all curves where  $V_{DD} = 3\text{ V}$ , all loads are referenced to 1.5 V.

**TYPICAL CHARACTERISTICS**

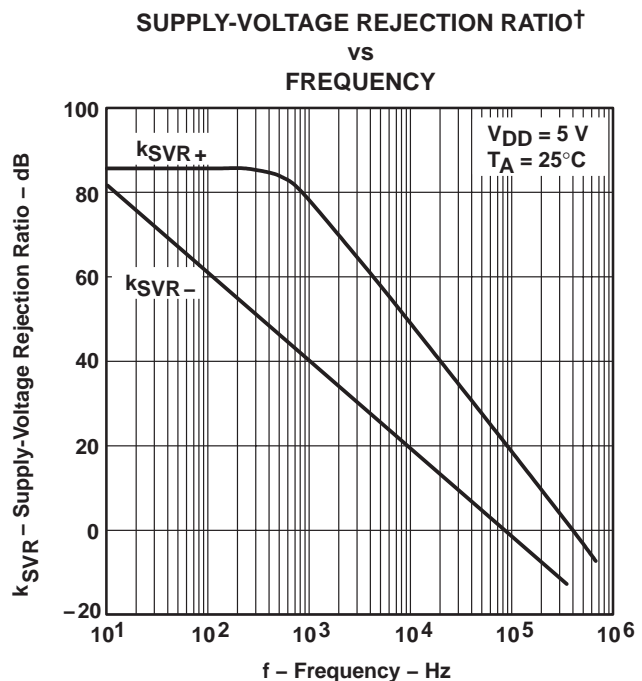
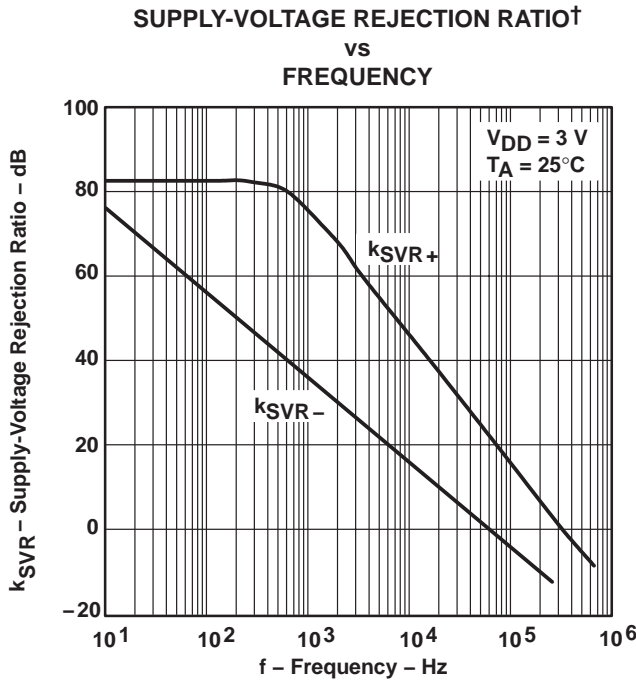
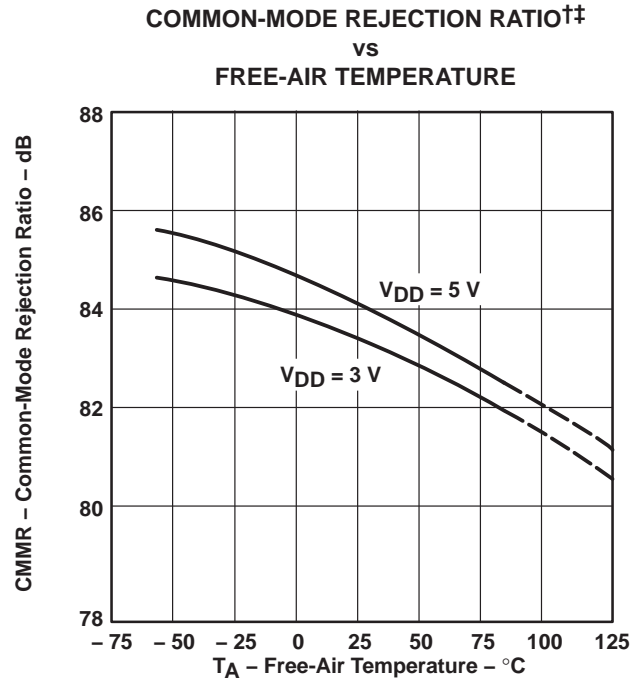
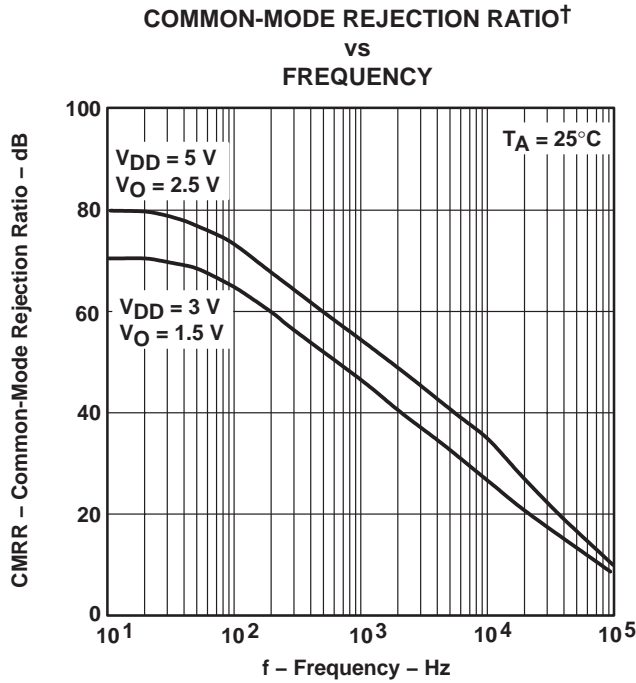

† For all curves where  $V_{DD} = 5\text{ V}$ , all loads are referenced to 2.5 V. For all curves where  $V_{DD} = 3\text{ V}$ , all loads are referenced to 1.5 V.  
 †† Data at high and low temperatures are applicable only within the rated operating free-air temperature ranges of the various devices.

**TLV2211, TLV2211Y**  
**Advanced LinCMOS™ RAIL-TO-RAIL**  
**MICROPOWER SINGLE OPERATIONAL AMPLIFIERS**

SLOS156E – MAY 1996 – REVISED SEPTEMBER 2006

**TYPICAL CHARACTERISTICS**

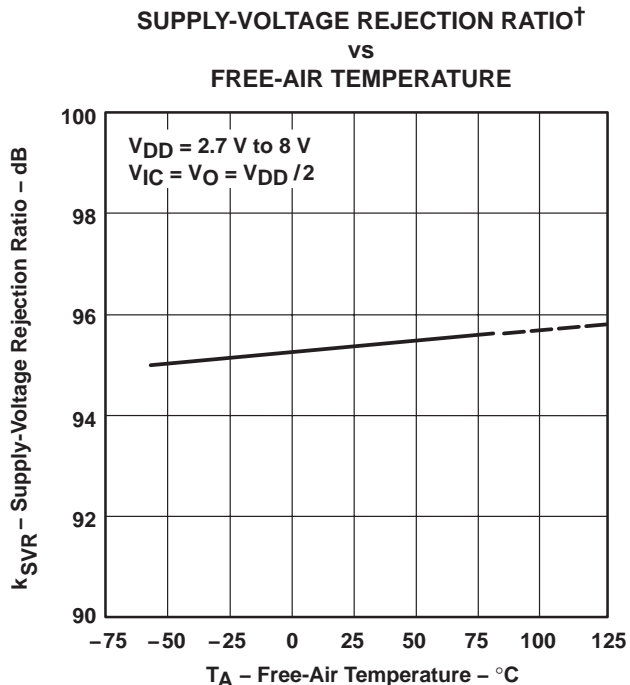

**Figure 33**

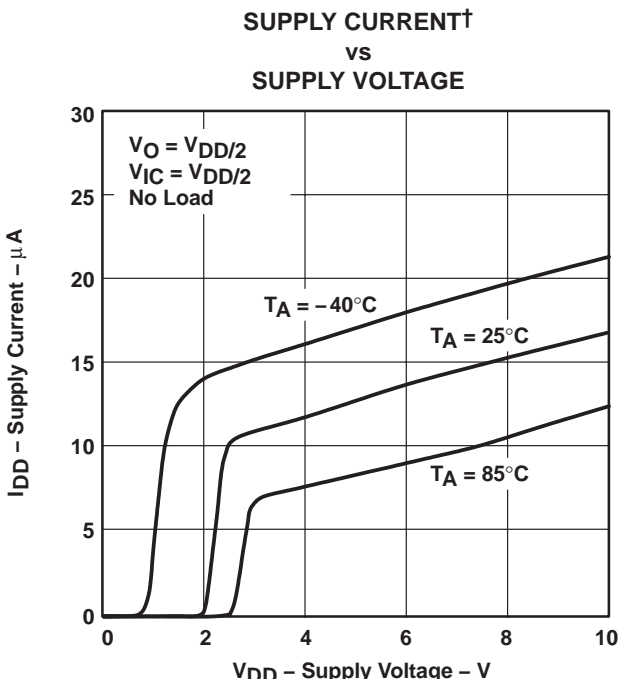

**Figure 34**

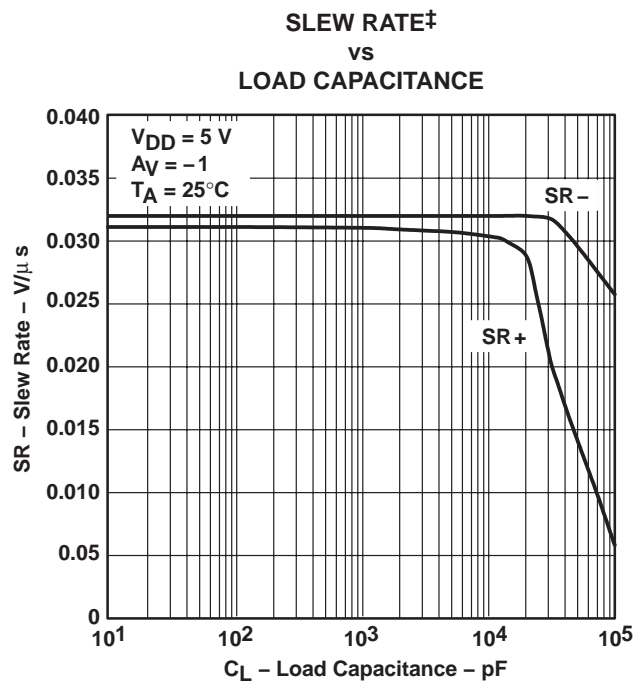

**Figure 35**

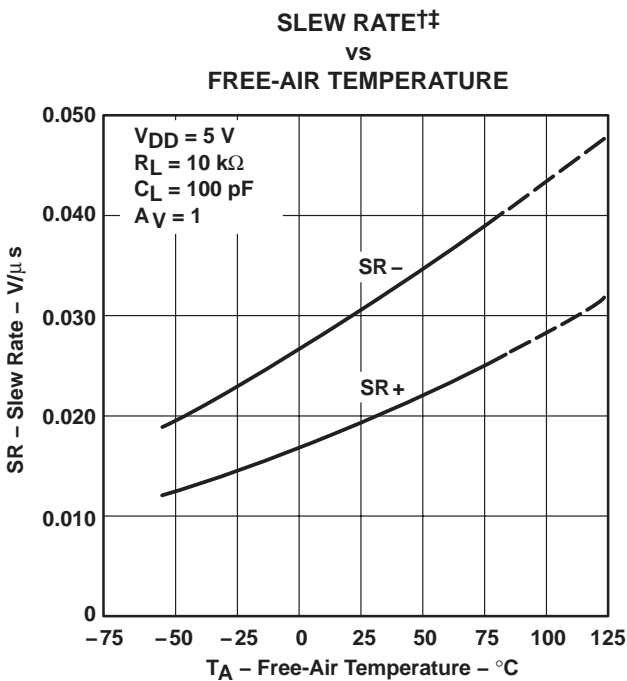

**Figure 36**

† Data at high and low temperatures are applicable only within the rated operating free-air temperature ranges of the various devices.

‡ For all curves where  $V_{DD} = 5 \text{ V}$ , all loads are referenced to 2.5 V. For all curves where  $V_{DD} = 3 \text{ V}$ , all loads are referenced to 1.5 V.



**TYPICAL CHARACTERISTICS**

**INVERTING LARGE-SIGNAL PULSE RESPONSE†**

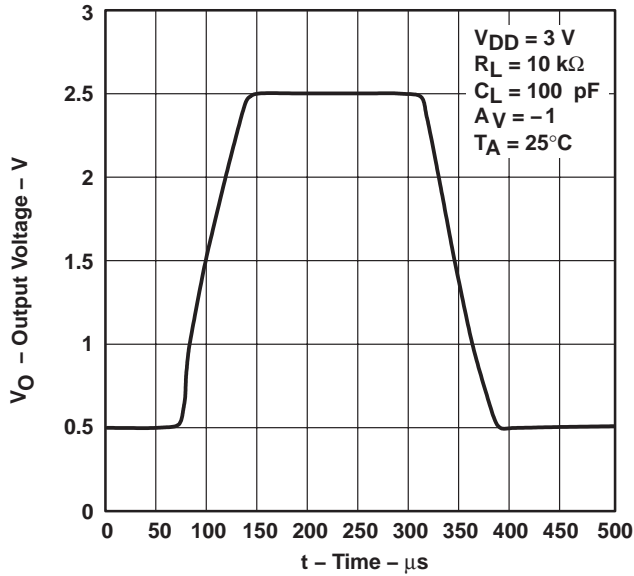

**Figure 37**

**INVERTING LARGE-SIGNAL PULSE RESPONSE†**

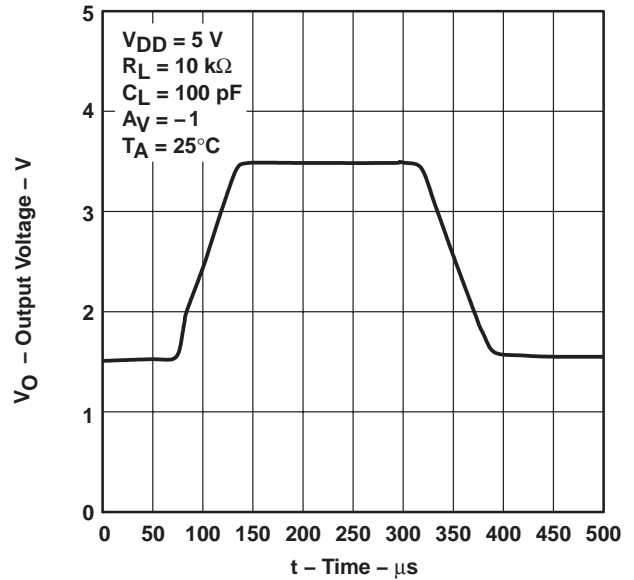

**Figure 38**

**VOLTAGE-FOLLOWER LARGE-SIGNAL PULSE RESPONSE†**

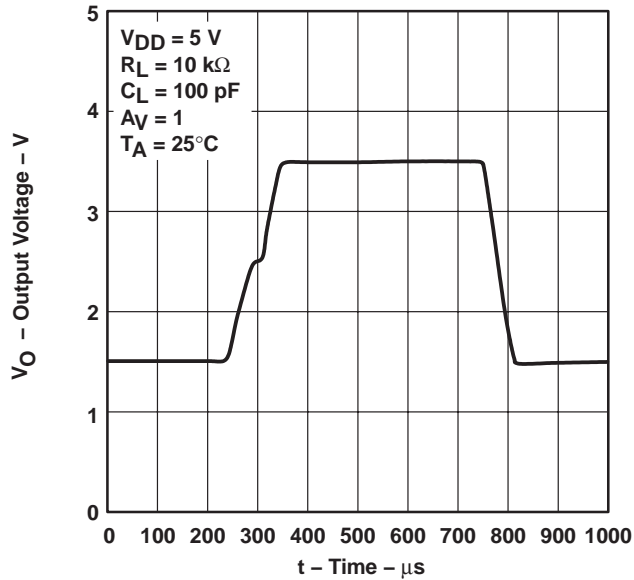

**Figure 39**

**VOLTAGE-FOLLOWER LARGE-SIGNAL PULSE RESPONSE†**

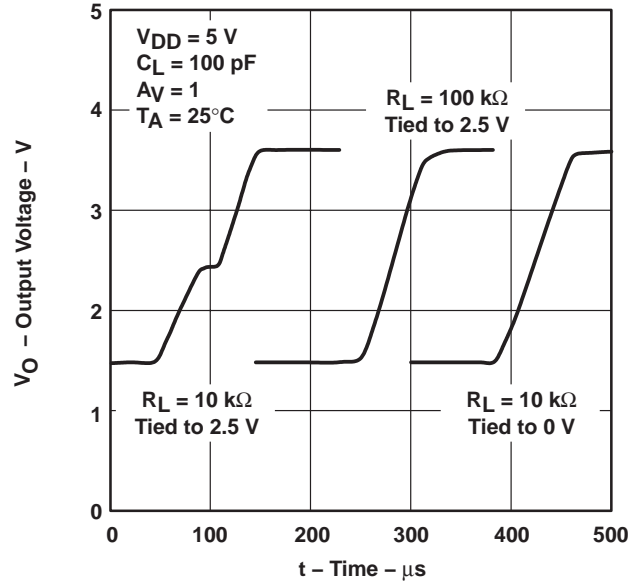

**Figure 40**

† For all curves where  $V_{DD} = 5\text{ V}$ , all loads are referenced to 2.5 V. For all curves where  $V_{DD} = 3\text{ V}$ , all loads are referenced to 1.5 V.

**TYPICAL CHARACTERISTICS**

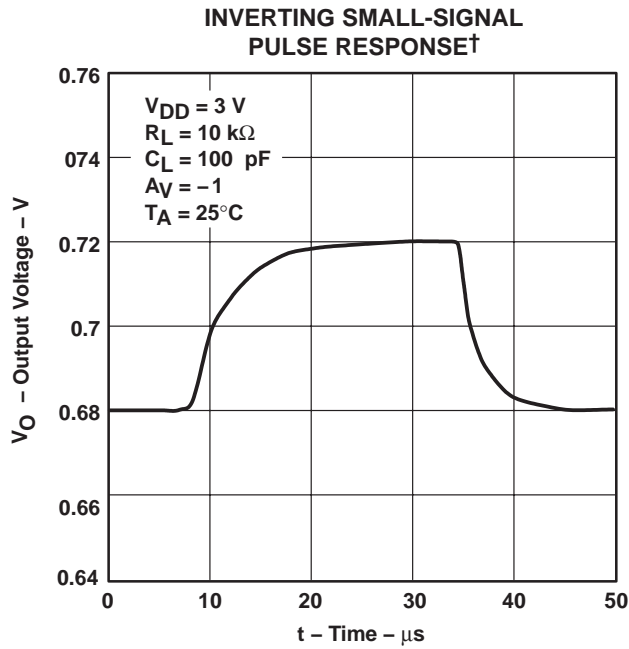

**Figure 41**

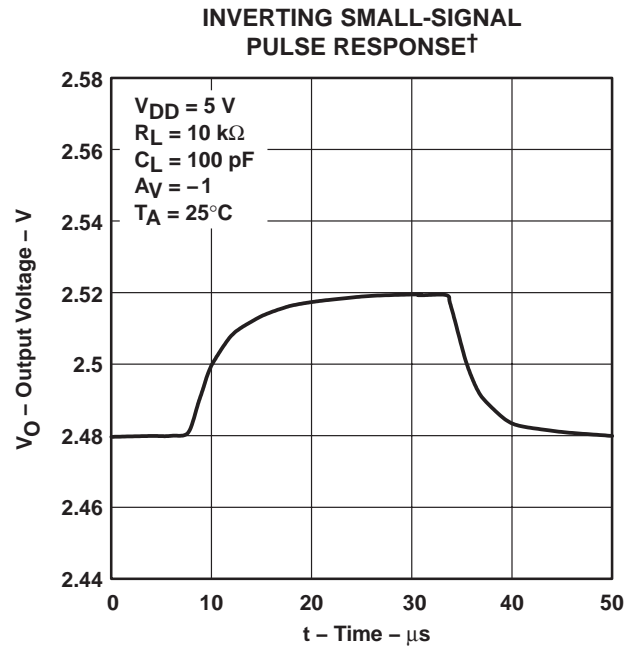

**Figure 42**

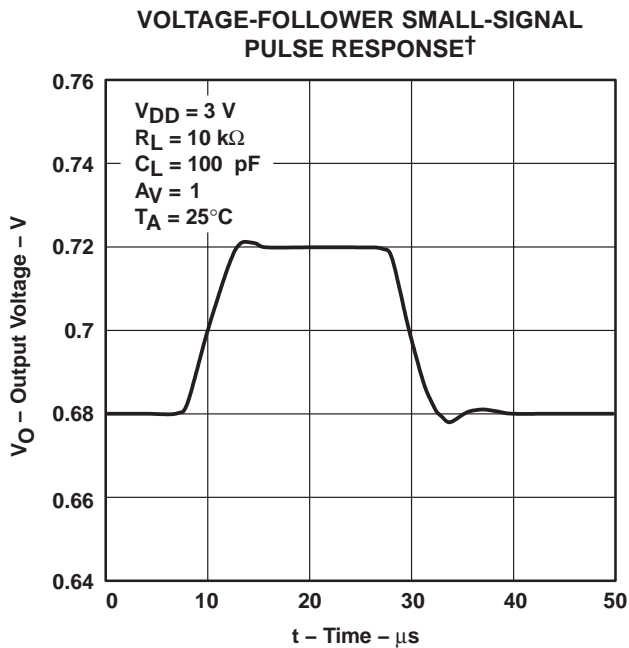

**Figure 43**

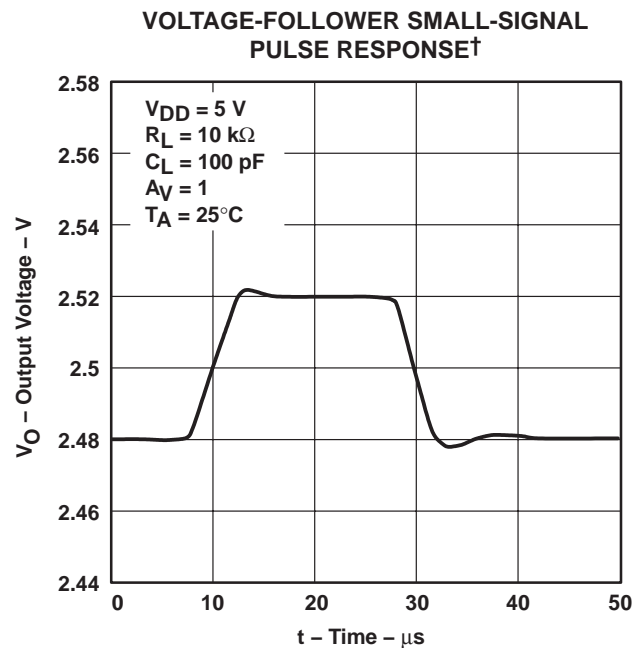

**Figure 44**

† For all curves where  $V_{DD} = 5\text{ V}$ , all loads are referenced to 2.5 V. For all curves where  $V_{DD} = 3\text{ V}$ , all loads are referenced to 1.5 V.

**TYPICAL CHARACTERISTICS**

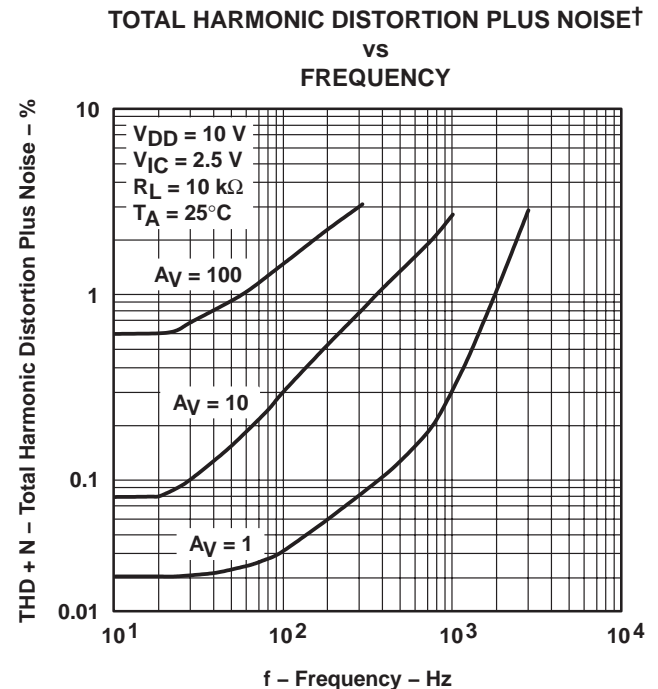
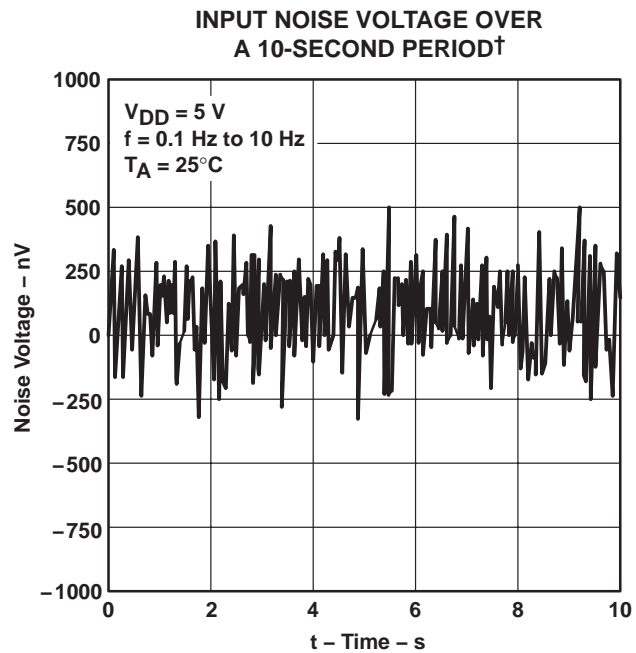
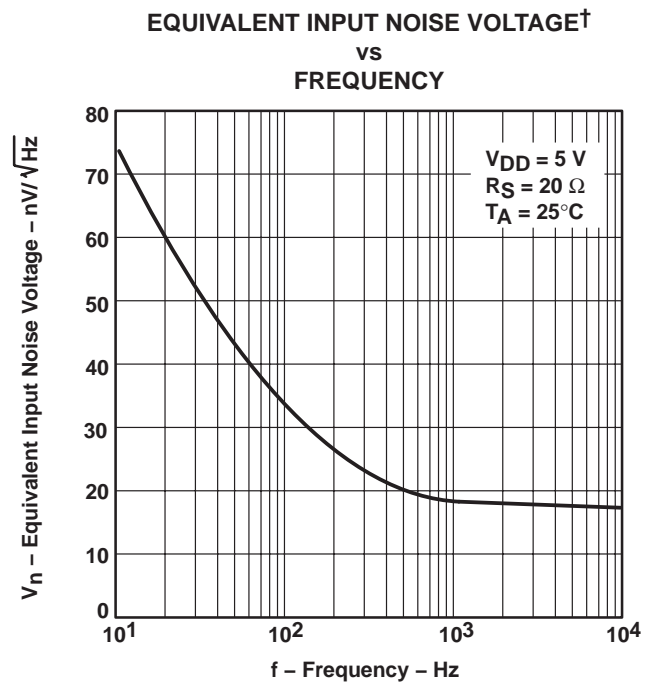
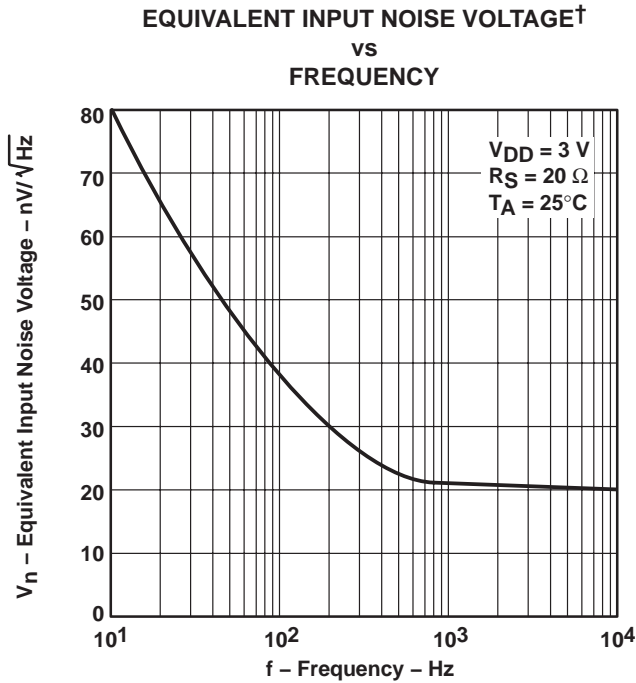

† For all curves where  $V_{DD} = 5\text{ V}$ , all loads are referenced to 2.5 V. For all curves where  $V_{DD} = 3\text{ V}$ , all loads are referenced to 1.5 V.

**TYPICAL CHARACTERISTICS**

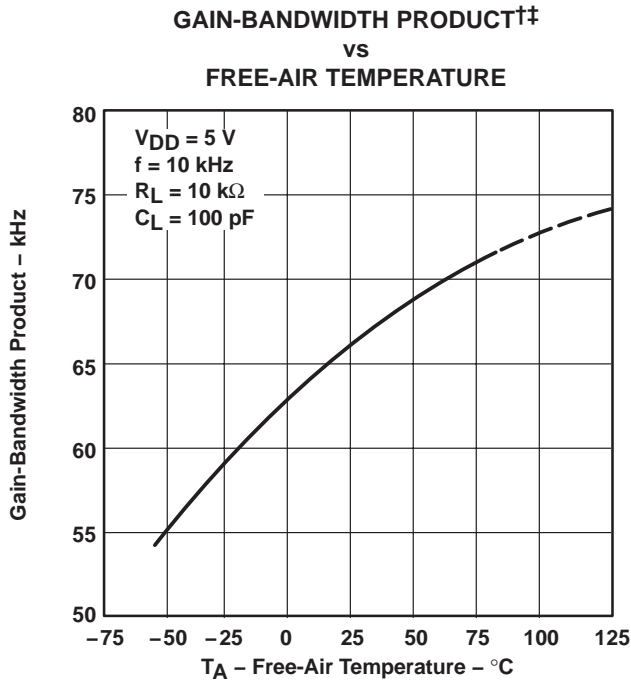

**Figure 49**

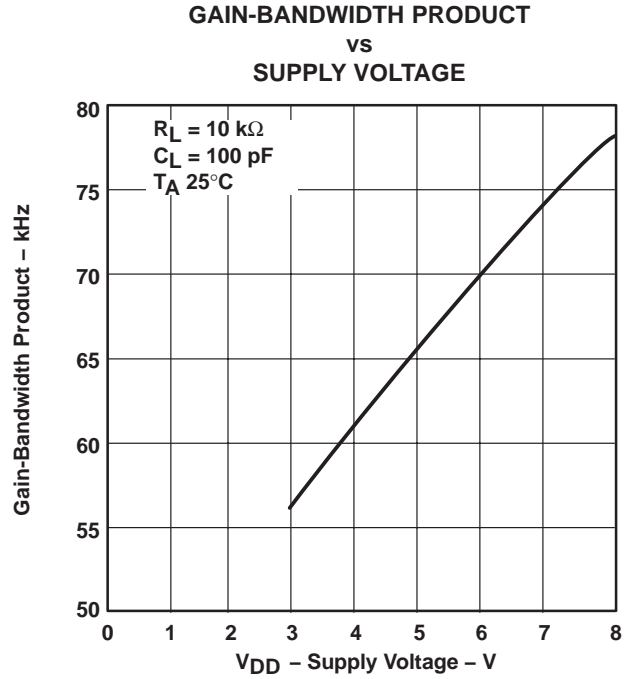

**Figure 50**

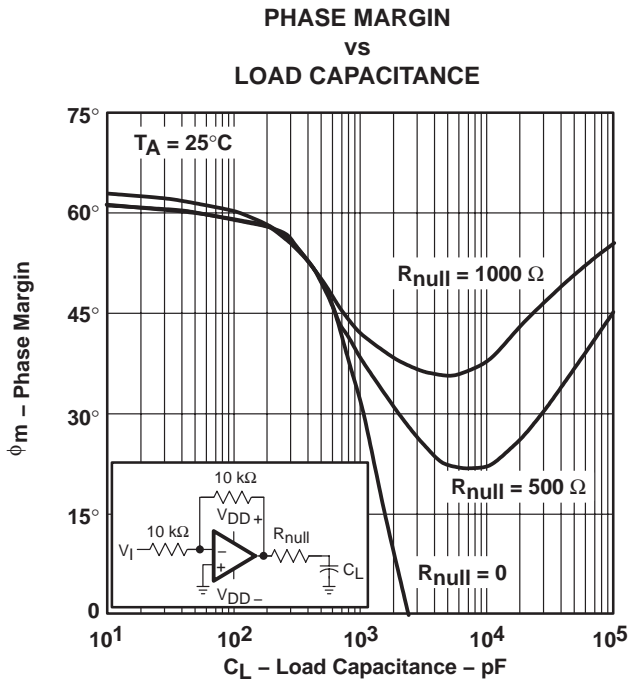

**Figure 51**

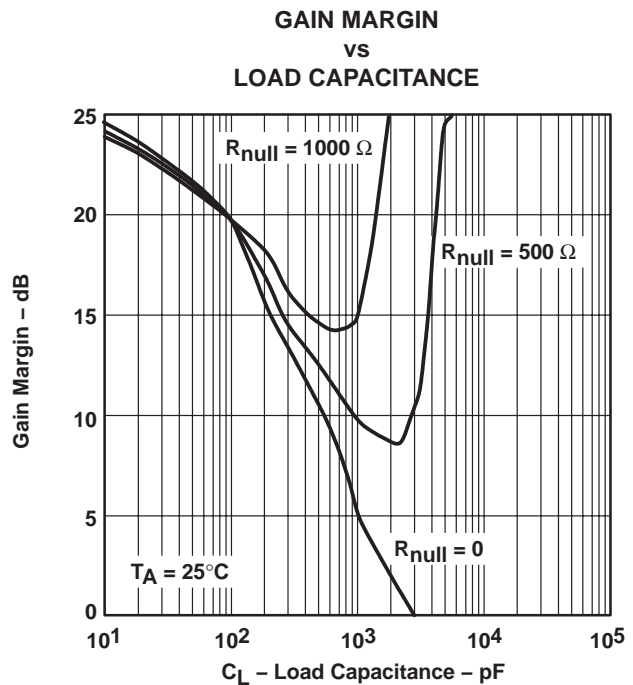
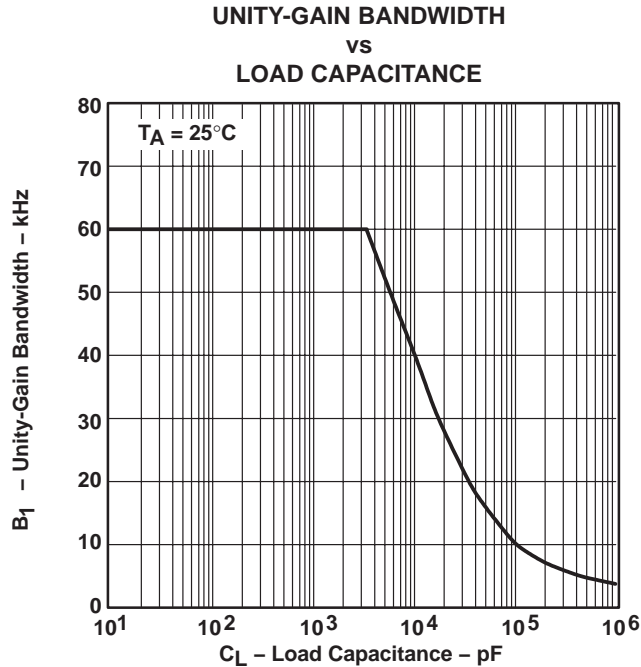

**Figure 52**

† Data at high and low temperatures are applicable only within the rated operating free-air temperature ranges of the various devices.  
 ‡ For all curves where  $V_{DD} = 5\text{ V}$ , all loads are referenced to 2.5 V. For all curves where  $V_{DD} = 3\text{ V}$ , all loads are referenced to 1.5 V.



**TYPICAL CHARACTERISTICS**



**Figure 53**

**APPLICATION INFORMATION**

**driving large capacitive loads**

The TLV2211 is designed to drive larger capacitive loads than most CMOS operational amplifiers. Figures 51 and 52 illustrate its ability to drive loads up to 600 pF while maintaining good gain and phase margins ( $R_{null} = 0$ ).

A smaller series resistor ( $R_{null}$ ) at the output of the device (see Figure 54) improves the gain and phase margins when driving large capacitive loads. Figures 51 and 52 show the effects of adding series resistances of 500  $\Omega$  and 1000  $\Omega$ . The addition of this series resistor has two effects: the first is that it adds a zero to the transfer function and the second is that it reduces the frequency of the pole associated with the output load in the transfer function.

The zero introduced to the transfer function is equal to the series resistance times the load capacitance. To calculate the improvement in phase margin, equation 1 can be used.

$$\Delta\phi_{m1} = \tan^{-1} \left( 2 \times \pi \times \text{UGBW} \times R_{null} \times C_L \right) \quad (1)$$

Where :

$\Delta\phi_{m1}$  = improvement in phase margin

UGBW = unity-gain bandwidth frequency

$R_{null}$  = output series resistance

$C_L$  = load capacitance

## APPLICATION INFORMATION

### driving large capacitive loads (continued)

The unity-gain bandwidth (UGBW) frequency decreases as the capacitive load increases (see Figure 54). To use equation 1, UGBW must be approximated from Figure 54.

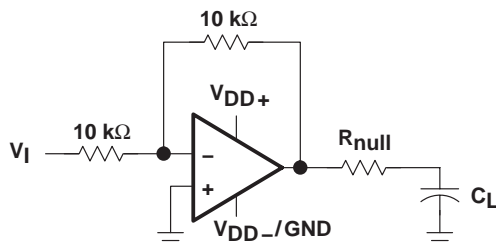

Figure 54. Series-Resistance Circuit

### driving heavy dc loads

The TLV2211 is designed to provide better sinking and sourcing output currents than earlier CMOS rail-to-rail output devices. This device is specified to sink 500  $\mu\text{A}$  and source 250  $\mu\text{A}$  at  $V_{\text{DD}} = 3\text{ V}$  and  $V_{\text{DD}} = 5\text{ V}$  at a maximum quiescent  $I_{\text{DD}}$  of 25  $\mu\text{A}$ . This provides a greater than 90% power efficiency.

When driving heavy dc loads, such as 10 k $\Omega$ , the positive edge can experience some distortion under slewing conditions. This condition can be seen in Figure 39. This condition is affected by three factors:

- Where the load is referenced. When the load is referenced to either rail, this condition does not occur. The distortion occurs only when the output signal swings through the point where the load is referenced. Figure 40 illustrates two 10-k $\Omega$  load conditions. The first load condition shows the distortion seen for a 10-k $\Omega$  load tied to 2.5 V. The third load condition shows no distortion for a 10-k $\Omega$  load tied to 0 V.
- Load resistance. As the load resistance increases, the distortion seen on the output decreases. Figure 40 illustrates the difference seen on the output for a 10-k $\Omega$  load and a 100-k $\Omega$  load with both tied to 2.5 V.
- Input signal edge rate. Faster input edge rates for a step input result in more distortion than with slower input edge rates.

## APPLICATION INFORMATION

### macromodel information

Macromodel information provided was derived using Microsim *Parts™*, the model generation software used with Microsim *PSpice™*. The Boyle macromodel (see Note 6) and subcircuit in Figure 54 are generated using the TLV2211 typical electrical and operating characteristics at  $T_A = 25^\circ\text{C}$ . Using this information, output simulations of the following key parameters can be generated to a tolerance of 20% (in most cases):

- Maximum positive output voltage swing
- Maximum negative output voltage swing
- Slew rate
- Quiescent power dissipation
- Input bias current
- Open-loop voltage amplification
- Unity-gain frequency
- Common-mode rejection ratio
- Phase margin
- DC output resistance
- AC output resistance
- Short-circuit output current limit

NOTE 6: G. R. Boyle, B. M. Cohn, D. O. Pederson, and J. E. Solomon, "Macromodeling of Integrated Circuit Operational Amplifiers", *IEEE Journal of Solid-State Circuits*, SC-9, 353 (1974).

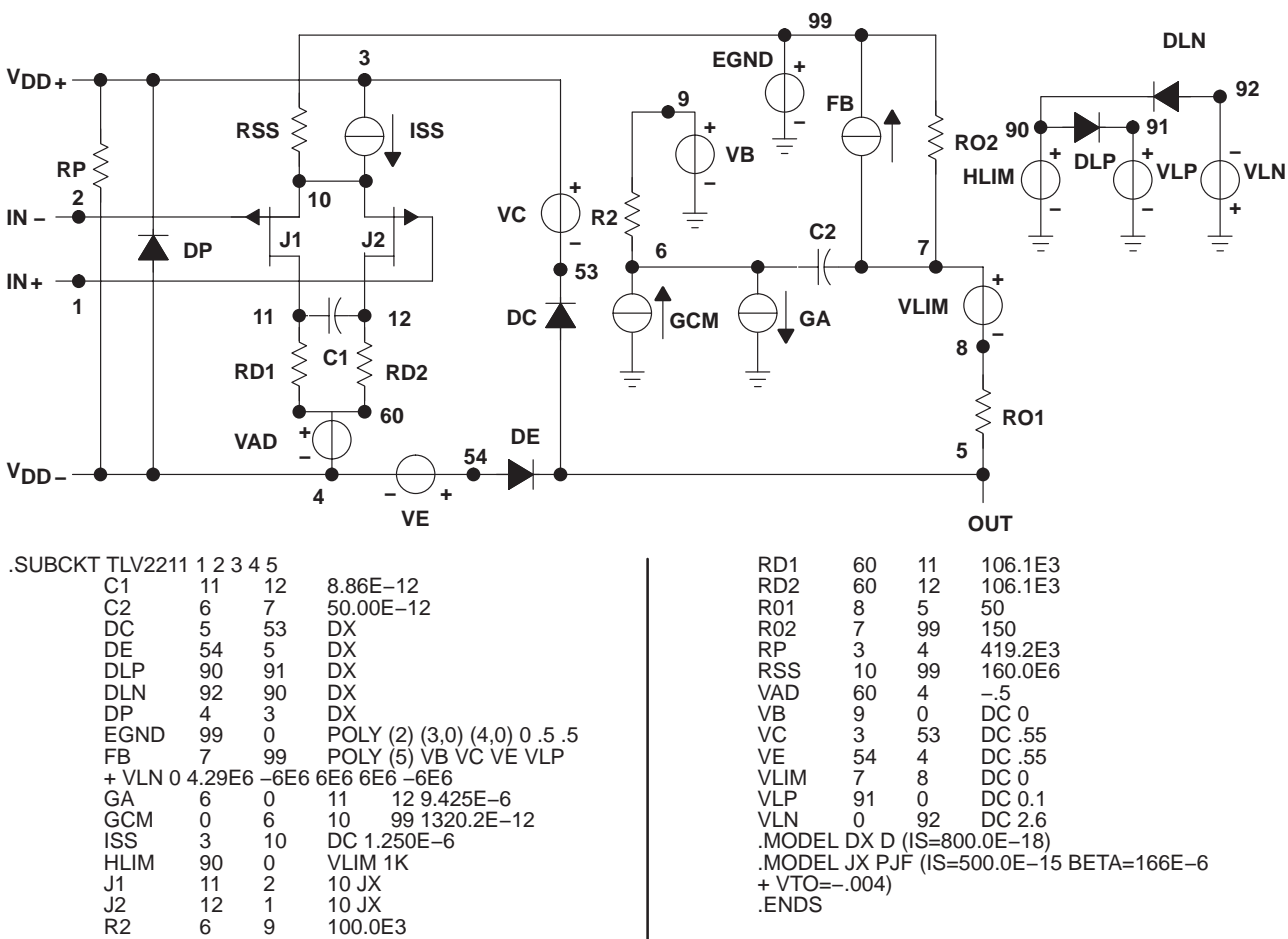

**Figure 55. Boyle Macromodel and Subcircuit**

*PSpice* and *Parts* are trademark of MicroSim Corporation.

Macromodels, simulation models, or other models provided by TI, directly or indirectly, are not warranted by TI as fully representing all of the specification and operating characteristics of the semiconductor product to which the model relates.



**TAPE AND REEL INFORMATION**



**QUADRANT ASSIGNMENTS FOR PIN 1 ORIENTATION IN TAPE**



\*All dimensions are nominal

Device	Package Type	Package Drawing	Pins	SPQ	Reel Diameter (mm)	Reel Width W1 (mm)	A0 (mm)	B0 (mm)	K0 (mm)	P1 (mm)	W (mm)	Pin1 Quadrant
TLV2211CDBVR	SOT-23	DBV	5	3000	180.0	9.0	3.15	3.2	1.4	4.0	8.0	Q3
TLV2211CDBVT	SOT-23	DBV	5	250	180.0	9.0	3.15	3.2	1.4	4.0	8.0	Q3
TLV2211IDBVR	SOT-23	DBV	5	3000	180.0	9.0	3.15	3.2	1.4	4.0	8.0	Q3
TLV2211IDBVT	SOT-23	DBV	5	250	180.0	9.0	3.15	3.2	1.4	4.0	8.0	Q3

**TAPE AND REEL BOX DIMENSIONS**



\*All dimensions are nominal

Device	Package Type	Package Drawing	Pins	SPQ	Length (mm)	Width (mm)	Height (mm)
TLV2211CDBVR	SOT-23	DBV	5	3000	182.0	182.0	20.0
TLV2211CDBVT	SOT-23	DBV	5	250	182.0	182.0	20.0
TLV2211IDBVR	SOT-23	DBV	5	3000	182.0	182.0	20.0
TLV2211IDBVT	SOT-23	DBV	5	250	182.0	182.0	20.0

DBV (R-PDSO-G5)

PLASTIC SMALL-OUTLINE PACKAGE



- NOTES:
- A. All linear dimensions are in millimeters.
  - B. This drawing is subject to change without notice.
  - C. Body dimensions do not include mold flash or protrusion. Mold flash and protrusion shall not exceed 0.15 per side.
  - D. Falls within JEDEC MO-178 Variation AA.

## IMPORTANT NOTICE

Texas Instruments Incorporated and its subsidiaries (TI) reserve the right to make corrections, modifications, enhancements, improvements, and other changes to its products and services at any time and to discontinue any product or service without notice. Customers should obtain the latest relevant information before placing orders and should verify that such information is current and complete. All products are sold subject to TI's terms and conditions of sale supplied at the time of order acknowledgment.

TI warrants performance of its hardware products to the specifications applicable at the time of sale in accordance with TI's standard warranty. Testing and other quality control techniques are used to the extent TI deems necessary to support this warranty. Except where mandated by government requirements, testing of all parameters of each product is not necessarily performed.

TI assumes no liability for applications assistance or customer product design. Customers are responsible for their products and applications using TI components. To minimize the risks associated with customer products and applications, customers should provide adequate design and operating safeguards.

TI does not warrant or represent that any license, either express or implied, is granted under any TI patent right, copyright, mask work right, or other TI intellectual property right relating to any combination, machine, or process in which TI products or services are used. Information published by TI regarding third-party products or services does not constitute a license from TI to use such products or services or a warranty or endorsement thereof. Use of such information may require a license from a third party under the patents or other intellectual property of the third party, or a license from TI under the patents or other intellectual property of TI.

Reproduction of TI information in TI data books or data sheets is permissible only if reproduction is without alteration and is accompanied by all associated warranties, conditions, limitations, and notices. Reproduction of this information with alteration is an unfair and deceptive business practice. TI is not responsible or liable for such altered documentation. Information of third parties may be subject to additional restrictions.

Resale of TI products or services with statements different from or beyond the parameters stated by TI for that product or service voids all express and any implied warranties for the associated TI product or service and is an unfair and deceptive business practice. TI is not responsible or liable for any such statements.

TI products are not authorized for use in safety-critical applications (such as life support) where a failure of the TI product would reasonably be expected to cause severe personal injury or death, unless officers of the parties have executed an agreement specifically governing such use. Buyers represent that they have all necessary expertise in the safety and regulatory ramifications of their applications, and acknowledge and agree that they are solely responsible for all legal, regulatory and safety-related requirements concerning their products and any use of TI products in such safety-critical applications, notwithstanding any applications-related information or support that may be provided by TI. Further, Buyers must fully indemnify TI and its representatives against any damages arising out of the use of TI products in such safety-critical applications.

TI products are neither designed nor intended for use in military/aerospace applications or environments unless the TI products are specifically designated by TI as military-grade or "enhanced plastic." Only products designated by TI as military-grade meet military specifications. Buyers acknowledge and agree that any such use of TI products which TI has not designated as military-grade is solely at the Buyer's risk, and that they are solely responsible for compliance with all legal and regulatory requirements in connection with such use.

TI products are neither designed nor intended for use in automotive applications or environments unless the specific TI products are designated by TI as compliant with ISO/TS 16949 requirements. Buyers acknowledge and agree that, if they use any non-designated products in automotive applications, TI will not be responsible for any failure to meet such requirements.

Following are URLs where you can obtain information on other Texas Instruments products and application solutions:

### Products

Amplifiers	<a href="http://amplifier.ti.com">amplifier.ti.com</a>
Data Converters	<a href="http://dataconverter.ti.com">dataconverter.ti.com</a>
DSP	<a href="http://dsp.ti.com">dsp.ti.com</a>
Clocks and Timers	<a href="http://www.ti.com/clocks">www.ti.com/clocks</a>
Interface	<a href="http://interface.ti.com">interface.ti.com</a>
Logic	<a href="http://logic.ti.com">logic.ti.com</a>
Power Mgmt	<a href="http://power.ti.com">power.ti.com</a>
Microcontrollers	<a href="http://microcontroller.ti.com">microcontroller.ti.com</a>
RFID	<a href="http://www.ti-rfid.com">www.ti-rfid.com</a>
RF/IF and ZigBee® Solutions	<a href="http://www.ti.com/lprf">www.ti.com/lprf</a>

### Applications

Audio	<a href="http://www.ti.com/audio">www.ti.com/audio</a>
Automotive	<a href="http://www.ti.com/automotive">www.ti.com/automotive</a>
Broadband	<a href="http://www.ti.com/broadband">www.ti.com/broadband</a>
Digital Control	<a href="http://www.ti.com/digitalcontrol">www.ti.com/digitalcontrol</a>
Medical	<a href="http://www.ti.com/medical">www.ti.com/medical</a>
Military	<a href="http://www.ti.com/military">www.ti.com/military</a>
Optical Networking	<a href="http://www.ti.com/opticalnetwork">www.ti.com/opticalnetwork</a>
Security	<a href="http://www.ti.com/security">www.ti.com/security</a>
Telephony	<a href="http://www.ti.com/telephony">www.ti.com/telephony</a>
Video & Imaging	<a href="http://www.ti.com/video">www.ti.com/video</a>
Wireless	<a href="http://www.ti.com/wireless">www.ti.com/wireless</a>

Mailing Address: Texas Instruments, Post Office Box 655303, Dallas, Texas 75265  
Copyright © 2008, Texas Instruments Incorporated