

SN54F573, SN74F573 OCTAL TRANSPARENT D-TYPE LATCHES WITH 3-STATE OUTPUTS

SDFS011A – MARCH 1987 – REVISED OCTOBER 1993

- Eight Latches in a Single Package
- 3-State Bus-Driving True Outputs
- Full Parallel Access for Loading
- Buffered Control Inputs
- Package Options Include Plastic Small-Outline Packages, Ceramic Chip Carriers, and Standard Plastic and Ceramic 300-mil DIPs

description

These 8-bit latches feature 3-state outputs designed specifically for driving highly capacitive or relatively low-impedance loads. They are particularly suitable for implementing buffer registers, I/O ports, bidirectional bus drivers, and working registers.

The eight latches of the 'F573 are transparent D-type latches. While the latch enable (LE) input is high, the Q outputs follow the data (D) inputs. When the latch enable is taken low, the Q outputs are latched at the logic levels set up at the D inputs.

A buffered output enable (\overline{OE}) input can be used to place the eight outputs in either a normal logic state (high or low logic levels) or a high-impedance state. In the high-impedance state, the outputs neither load nor drive the bus lines significantly. The high-impedance state and increased drive provide the capability to drive bus lines without need for interface or pullup components.

The output enable (\overline{OE}) input does not affect the internal operations of the latches. Old data can be retained or new data can be entered while the outputs are in the high-impedance state.

The SN54F573 is characterized for operation over the full military temperature range of -55°C to 125°C . The SN74F573 is characterized for operation from 0°C to 70°C .

SN54F573 . . . J PACKAGE
SN74F573 . . . DW OR N PACKAGE
(TOP VIEW)

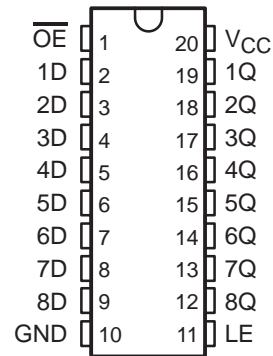

SN54F573 . . . FK PACKAGE
(TOP VIEW)

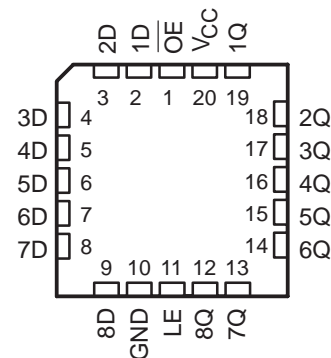

FUNCTION TABLE
(each latch)

INPUTS			OUTPUT
\overline{OE}	LE	D	Q
L	H	H	H
L	H	L	L
L	L	X	Q_0
H	X	X	Z

SN54F573, SN74F573 OCTAL TRANSPARENT D-TYPE LATCHES WITH 3-STATE OUTPUTS

SDFS011A – MARCH 1987 – REVISED OCTOBER 1993

logic symbol†

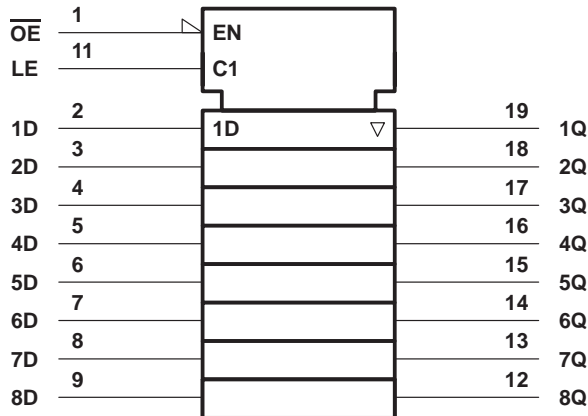

logic diagram (positive logic)

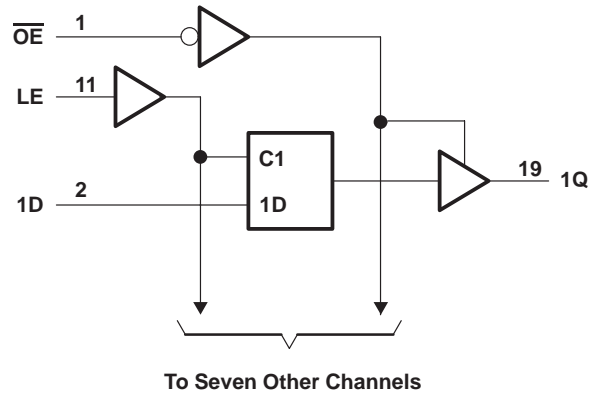

† This symbol is in accordance with ANSI/IEEE Std 91-1984 and IEC Publication 617-12.

absolute maximum ratings over operating free-air temperature range (unless otherwise noted)‡

Supply voltage range, V_{CC}	-0.5 V to 7 V
Input voltage range, V_I (see Note 1)	-1.2 V to 7 V
Input current range	-30 mA to 5 mA
Voltage range applied to any output in the disabled or power-off state	-0.5 V to 5.5 V
Voltage range applied to any output in the high state	-0.5 V to V_{CC}
Current into any output in the low state: SN54F573	40 mA
SN74F573	48 mA
Operating free-air temperature range: SN54F573	-55°C to 125°C
SN74F573	0°C to 70°C
Storage temperature range	-65°C to 150°C

‡ Stresses beyond those listed under "absolute maximum ratings" may cause permanent damage to the device. These are stress ratings only and functional operation of the device at these or any other conditions beyond those indicated under "recommended operating conditions" is not implied. Exposure to absolute-maximum-rated conditions for extended periods may affect device reliability.

NOTE 1: The input voltage ratings may be exceeded provided the input current ratings are observed.

recommended operating conditions

		SN54F573			SN74F573			UNIT
		MIN	NOM	MAX	MIN	NOM	MAX	
V_{CC}	Supply voltage	4.5	5	5.5	4.5	5	5.5	V
V_{IH}	High-level input voltage	2			2			V
V_{IL}	Low-level input voltage			0.8			0.8	V
I_{IK}	Input clamp current			-18			-18	mA
I_{OH}	High-level output current			-3			-3	mA
I_{OL}	Low-level output current			20			24	mA
T_A	Operating free-air temperature	-55		125	0		70	°C

SN54F573, SN74F573 OCTAL TRANSPARENT D-TYPE LATCHES WITH 3-STATE OUTPUTS

SDFS011A – MARCH 1987 – REVISED OCTOBER 1993

electrical characteristics over recommended operating free-air temperature range (unless otherwise noted)

PARAMETER	TEST CONDITIONS		SN54F573			SN74F573			UNIT
			MIN	TYP†	MAX	MIN	TYP†	MAX	
V_{IK}	$V_{CC} = 4.5\text{ V}$,	$I_I = -18\text{ mA}$	-1.2			-1.2			V
V_{OH}	$V_{CC} = 4.5\text{ V}$	$I_{OH} = -1\text{ mA}$	2.5	3.4		2.5	3.4		V
		$I_{OH} = -3\text{ mA}$	2.4	3.3		2.4	3.3		
V_{OL}	$V_{CC} = 4.5\text{ V}$	$I_{OL} = 20\text{ mA}$	0.3			0.35			V
		$I_{OL} = 24\text{ mA}$	0.5			0.5			
I_{OZH}	$V_{CC} = 5.5\text{ V}$,	$V_O = 2.7\text{ V}$	50			50			μA
I_{OZL}	$V_{CC} = 5.5\text{ V}$,	$V_O = 0.5\text{ V}$	-50			-50			μA
I_I	$V_{CC} = 5.5\text{ V}$,	$V_I = 7\text{ V}$	0.1			0.1			mA
I_{IH}	$V_{CC} = 5.5\text{ V}$,	$V_I = 2.7\text{ V}$	20			20			μA
I_{IL}	$V_{CC} = 5.5\text{ V}$,	$V_I = 0.5\text{ V}$	-0.6			-0.6			mA
I_{OS}^\ddagger	$V_{CC} = 5.5\text{ V}$,	$V_O = 0$	-60			-60			mA
I_{CCZ}	$V_{CC} = 5.5\text{ V}$,	See Note 2	38			38			mA

† All typical values are at $V_{CC} = 5\text{ V}$, $T_A = 25^\circ\text{C}$.

‡ Not more than one output should be shorted at a time, and the duration of the short circuit should not exceed one second.

NOTE 2: I_{CCZ} is measured with \overline{OE} at 4.5 V and all other inputs grounded.

timing requirements over recommended ranges of supply voltage and operating free-air temperature (unless otherwise noted)

		$V_{CC} = 5\text{ V}$, $T_A = 25^\circ\text{C}$		SN54F573		SN74F573		UNIT
		'F573						
		MIN	MAX	MIN	MAX	MIN	MAX	
t_w	Pulse duration, LE high	6		6		6		ns
t_{su}	Setup time, data before LE↓	2		2		2		ns
t_h	Hold time, data after LE↓	3		3		3		ns

switching characteristics (see Note 3)

PARAMETER	FROM (INPUT)	TO (OUTPUT)	$V_{CC} = 5\text{ V}$, $C_L = 50\text{ pF}$, $R_L = 500\ \Omega$, $T_A = 25^\circ\text{C}$			$V_{CC} = 4.5\text{ V to }5.5\text{ V}$, $C_L = 50\text{ pF}$, $R_L = 500\ \Omega$, $T_A = \text{MIN to MAX}^\S$				UNIT
			'F573			SN54F573		SN74F573		
			MIN	TYP	MAX	MIN	MAX	MIN	MAX	
t_{PLH}	D	Q	2	4.9	7	1.5	9	2.2	8	ns
t_{PHL}			1.2	3.3	5	1	8	1.2	6	
t_{PLH}	LE	Q	4.2	8.6	11.5	3.7	13.5	4.2	13	ns
t_{PHL}			2.2	4.8	7	1.5	9	2.2	8	
t_{PZH}	\overline{OE}	Q	1.2	4.6	11	1	13	1.2	12	ns
t_{PZL}			1.2	5.2	7.5	1	10	1.2	8.5	
t_{PHZ}	\overline{OE}	Q	1.2	4.1	6.5	1	8.5	1.2	7.5	ns
t_{PLZ}			1.2	3.4	6	1	7	1.2	6	

§ For conditions shown as MIN or MAX, use the appropriate value specified under recommended operating conditions.

NOTE 3: Load circuits and waveforms are shown in Section 1.



IMPORTANT NOTICE

Texas Instruments and its subsidiaries (TI) reserve the right to make changes to their products or to discontinue any product or service without notice, and advise customers to obtain the latest version of relevant information to verify, before placing orders, that information being relied on is current and complete. All products are sold subject to the terms and conditions of sale supplied at the time of order acknowledgement, including those pertaining to warranty, patent infringement, and limitation of liability.

TI warrants performance of its semiconductor products to the specifications applicable at the time of sale in accordance with TI's standard warranty. Testing and other quality control techniques are utilized to the extent TI deems necessary to support this warranty. Specific testing of all parameters of each device is not necessarily performed, except those mandated by government requirements.

CERTAIN APPLICATIONS USING SEMICONDUCTOR PRODUCTS MAY INVOLVE POTENTIAL RISKS OF DEATH, PERSONAL INJURY, OR SEVERE PROPERTY OR ENVIRONMENTAL DAMAGE ("CRITICAL APPLICATIONS"). TI SEMICONDUCTOR PRODUCTS ARE NOT DESIGNED, AUTHORIZED, OR WARRANTED TO BE SUITABLE FOR USE IN LIFE-SUPPORT DEVICES OR SYSTEMS OR OTHER CRITICAL APPLICATIONS. INCLUSION OF TI PRODUCTS IN SUCH APPLICATIONS IS UNDERSTOOD TO BE FULLY AT THE CUSTOMER'S RISK.

In order to minimize risks associated with the customer's applications, adequate design and operating safeguards must be provided by the customer to minimize inherent or procedural hazards.

TI assumes no liability for applications assistance or customer product design. TI does not warrant or represent that any license, either express or implied, is granted under any patent right, copyright, mask work right, or other intellectual property right of TI covering or relating to any combination, machine, or process in which such semiconductor products or services might be or are used. TI's publication of information regarding any third party's products or services does not constitute TI's approval, warranty or endorsement thereof.