

ULTRALOW-NOISE, HIGH PSRR, FAST RF 500-mA LOW-DROPOUT LINEAR REGULATORS

FEATURES

- 500-mA Low-Dropout Regulator With EN
- Available in 1.6-V, 1.8-V, 2.5-V, 3-V, 3.3-V, and Adjustable
- High PSRR (50 dB at 10 kHz)
- Ultralow Noise (33 μ V)
- Fast Start-Up Time (50 μ s)
- Stable With a 1- μ F Ceramic Capacitor
- Excellent Load/Line Transient
- Very Low Dropout Voltage (110 mV at Full Load, TPS79530)
- 5-Pin SOT223-5 Package

APPLICATIONS

- Powering Noise-Sensitive Circuitry
 - RF
 - Audio
 - VCOs
- DSP/FPGA/Microprocessor Supplies
- Post Regulator for Switching Supplies

DESCRIPTION

The TPS795xx family of low-dropout (LDO) low-power linear voltage regulators features high power supply rejection ratio (PSRR), ultralow noise, fast start-up, and excellent line and load transient responses in a small outline, SOT223-5, package. Each device in the family is stable with a small 1- μ F ceramic capacitor on the output. The family uses an advanced, proprietary BiCMOS fabrication process to yield extremely low dropout voltages (e.g., 110 mV at 500 mA). Each device achieves fast start-up times (approximately 50 μ s with a 0.001- μ F bypass capacitor) while consuming very low quiescent current (265 μ A typical). Moreover, when the device is placed in standby mode, the supply current is reduced to less than 1 μ A. The TPS79530 exhibits approximately 33 μ V_{RMS} of output voltage noise with a 0.1- μ F bypass capacitor. Applications with analog components that are noise sensitive, such as portable RF electronics, benefit from the high PSRR and low noise features, as well as the fast response time.

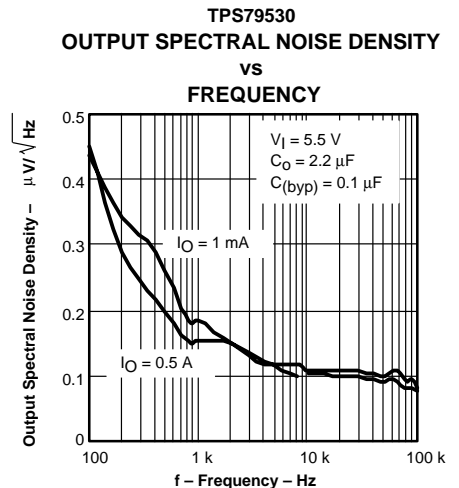
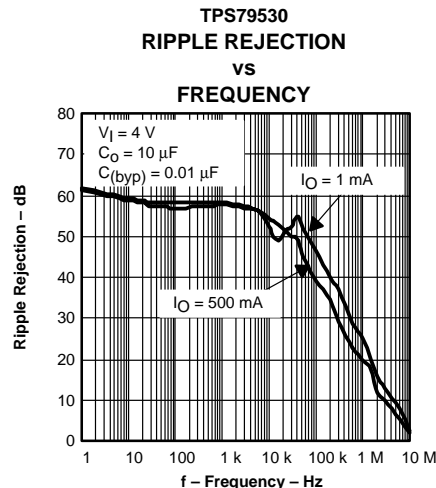
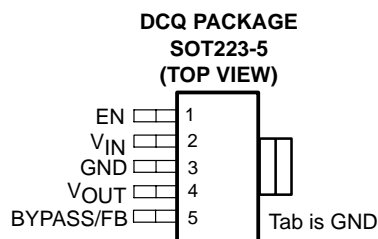

Please be aware that an important notice concerning availability, standard warranty, and use in critical applications of Texas Instruments semiconductor products and disclaimers thereto appears at the end of this data sheet.

**TPS79501, TPS79516, TPS79518
TPS79525, TPS79530, TPS79533**

SLVS350A – OCTOBER 2002 – REVISED MARCH 2003

AVAILABLE OPTIONS

T _J	VOLTAGE	PACKAGE	PART NUMBER†	SYMBOL
-40°C to 125°C	1.2 to 5.5 V	SOT223-5	TPS79501DCQ	PS79501
	1.6 V		TPS79516DCQ	PS79516
	1.8 V		TPS79518DCQ	PS79518
	2.5 V		TPS79525DCQ	PS79525
	3 V		TPS79530DCQ	PS79530
	3.3 V		TPS79533DCQ	PS79533

† Add a R suffix to indicate tape and reel of 2500 parts. (e.g., TPS79501DCQR)

absolute maximum ratings over operating free-air temperature (unless otherwise noted)(‡)

Input voltage range, V _I (see Note 1)	-0.3 V to 6 V
Voltage range at EN	-0.3 V to V _I + 0.3 V
Voltage on OUT, V _O	6 V
Peak output current	Internally limited
ESD rating, HBM	2 kV
ESD rating, CDM	500 V
Continuous total power dissipation	See Dissipation Rating Table
Operating virtual junction temperature range, T _J	-40°C to 150°C
Storage temperature range, T _{stg}	-65°C to 150°C

‡ Stresses above these ratings may cause permanent damage. Exposure to absolute maximum conditions for extended periods may degrade device reliability. These are stress ratings only, and functional operation of the device at these or any other conditions beyond those specified is not implied.

NOTE 1: All voltage values are with respect to network ground terminal.

DISSIPATION RATING TABLE

PACKAGE	BOARD	R _{θJC}	R _{θJA}
SOT223	Low K§	15°C/W	53°C/W

§ The JEDEC low K (1s) board design used to derive this data was a 3-inch × 3-inch (7.5 cm × 7.5cm), two-layer board with 2 ounce copper traces on top of the board.

electrical characteristics over recommended operating free-air temperature range $EN = V_I$,
 $T_J = -40$ to 125°C , $V_I = V_O(\text{typ}) + 1\text{ V}$, $I_O = 1\text{ mA}$, $C_O = 10\text{ }\mu\text{F}$, $C(\text{byp}) = 0.01\text{ }\mu\text{F}$ (unless otherwise noted)

PARAMETER	TEST CONDITIONS		MIN	TYP	MAX	UNIT
Input voltage, V_I (see Note 2)			2.7		5.5	V
Continuous output current, I_O (see Note 3)			0		500	mA
Operating junction temperature, T_J			-40		125	$^\circ\text{C}$
Output voltage	TPS79501	$T_J = 25^\circ\text{C}$	V_O			V
		$0\text{ }\mu\text{A} < I_O < 500\text{ mA}$, (see Note 4) $1.22\text{ V} \leq V_O \leq 5.5\text{ V}$	$0.98\text{ }V_O$	$1.02\text{ }V_O$		
	TPS79516	$T_J = 25^\circ\text{C}$	1.6			
		$0\text{ }\mu\text{A} < I_O < 500\text{ mA}$, $2.6\text{ V} < V_I < 5.5\text{ V}$	1.568	1.632		
	TPS79518	$T_J = 25^\circ\text{C}$	1.8			
		$0\text{ }\mu\text{A} < I_O < 500\text{ mA}$, $2.8\text{ V} < V_I < 5.5\text{ V}$	1.764	1.836		
	TPS79525	$T_J = 25^\circ\text{C}$	2.5			
		$0\text{ }\mu\text{A} < I_O < 500\text{ mA}$, $3.5\text{ V} < V_I < 5.5\text{ V}$	2.45	2.55		
	TPS79530	$T_J = 25^\circ\text{C}$	3			
		$0\text{ }\mu\text{A} < I_O < 500\text{ mA}$, $4\text{ V} < V_I < 5.5\text{ V}$	2.94	3.06		
	TPS79533	$T_J = 25^\circ\text{C}$	3.3			
		$0\text{ }\mu\text{A} < I_O < 500\text{ mA}$, $4.3\text{ V} < V_I < 5.5\text{ V}$	3.234	3.366		
Quiescent current (GND current)	$0\text{ }\mu\text{A} < I_O < 500\text{ mA}$, $T_J = 25^\circ\text{C}$		265			μA
	$0\text{ }\mu\text{A} < I_O < 500\text{ mA}$				385	
Load regulation	$0\text{ }\mu\text{A} < I_O < 500\text{ mA}$, $T_J = 25^\circ\text{C}$		3			mV
Output voltage line regulation ($\Delta V_O/V_O$) (see Note 5)	$V_O + 1\text{ V} < V_I \leq 5.5\text{ V}$, $T_J = 25^\circ\text{C}$		0.05			%V
	$V_O + 1\text{ V} < V_I \leq 5.5\text{ V}$				0.12	
Output noise voltage (TPS79530)	BW = 100 Hz to 100 kHz, $I_O = 500\text{ mA}$, $T_J = 25^\circ\text{C}$	$C(\text{byp}) = 0.001\text{ }\mu\text{F}$	46			μVRMS
		$C(\text{byp}) = 0.0047\text{ }\mu\text{F}$	41			
		$C(\text{byp}) = 0.01\text{ }\mu\text{F}$	35			
		$C(\text{byp}) = 0.1\text{ }\mu\text{F}$	33			
Time, start-up (TPS79530)	$R_L = 6\text{ }\Omega$, $C_O = 1\text{ }\mu\text{F}$, $T_J = 25^\circ\text{C}$	$C(\text{byp}) = 0.001\text{ }\mu\text{F}$	50			μs
		$C(\text{byp}) = 0.0047\text{ }\mu\text{F}$	75			
		$C(\text{byp}) = 0.01\text{ }\mu\text{F}$	110			
Output current limit	$V_O = 0\text{ V}$,	See Note 4	2.4	2.8	3.5	A
Standby current	$EN = 0\text{ V}$,	$2.7\text{ V} < V_I < 5.5\text{ V}$	0.07		1	μA
High-level enable input voltage	$2.7\text{ V} < V_I < 5.5\text{ V}$		2			V
Low-level enable input voltage	$2.7\text{ V} < V_I < 5.5\text{ V}$				0.7	V
Input current (EN)	$EN = 0$		-1		1	μA
Input current (FB)	$FB = 1.8\text{ V}$				1	μA

NOTES: 2. To calculate the minimum input voltage for your maximum output current, use the following formula:

$$V_{I(\text{min})} = V_{O(\text{max})} + V_{DO}(\text{max load})$$

- Continuous output current and operating junction temperature are limited by internal protection circuitry, but it is not recommended that the device operate under conditions beyond those specified in this table for extended periods of time.
- The minimum IN operating voltage is 2.7 V or $V_{O(\text{typ})} + 1\text{ V}$, whichever is greater. The maximum IN voltage is 5.5 V. The maximum output current is 500 mA.
- If $V_O \leq 2.5\text{ V}$ then $V_{I\text{min}} = 2.7\text{ V}$, $V_{I\text{max}} = 5.5\text{ V}$:

$$\text{Line reg. (mV)} = (\%V) \times \frac{V_O(V_{I\text{max}} - 2.7\text{ V})}{100} \times 1000$$

If $V_O \geq 2.5\text{ V}$ then $V_{I\text{min}} = V_O + 1\text{ V}$, $V_{I\text{max}} = 5.5\text{ V}$.

**TPS79501, TPS79516, TPS79518
TPS79525, TPS79530, TPS79533**

SLVS350A – OCTOBER 2002 – REVISED MARCH 2003

electrical characteristics over recommended operating free-air temperature range $EN = V_I$, $T_J = -40$ to 125°C , $V_I = V_{O(\text{typ})} + 1\text{ V}$, $I_O = 1\text{ mA}$, $C_O = 10\ \mu\text{F}$, $C(\text{byp}) = 0.01\ \mu\text{F}$ (unless otherwise noted) (continued)

PARAMETER		TEST CONDITIONS	MIN	TYP	MAX	UNIT
Power supply ripple rejection	TPS79530	$f = 100\text{ Hz}$, $T_J = 25^\circ\text{C}$, $I_O = 10\text{ mA}$		59		dB
		$f = 100\text{ Hz}$, $T_J = 25^\circ\text{C}$, $I_O = 500\text{ mA}$		58		
		$f = 10\text{ kHz}$, $T_J = 25^\circ\text{C}$, $I_O = 500\text{ mA}$		50		
		$f = 100\text{ kHz}$, $T_J = 25^\circ\text{C}$, $I_O = 500\text{ mA}$		39		
Dropout voltage (see Note 6)	TPS79530	$I_O = 500\text{ mA}$, $T_J = 25^\circ\text{C}$		110		mV
		$I_O = 500\text{ mA}$			170	
	TPS79533	$I_O = 500\text{ mA}$, $T_J = 25^\circ\text{C}$		105		
		$I_O = 500\text{ mA}$			160	

NOTE 6: I_N voltage equals $V_{O(\text{typ})} - 100\text{ mV}$; The TPS79516, TPS79518, and TPS79525 dropout voltages are limited by the input voltage range limitations.

functional block diagram—adjustable version

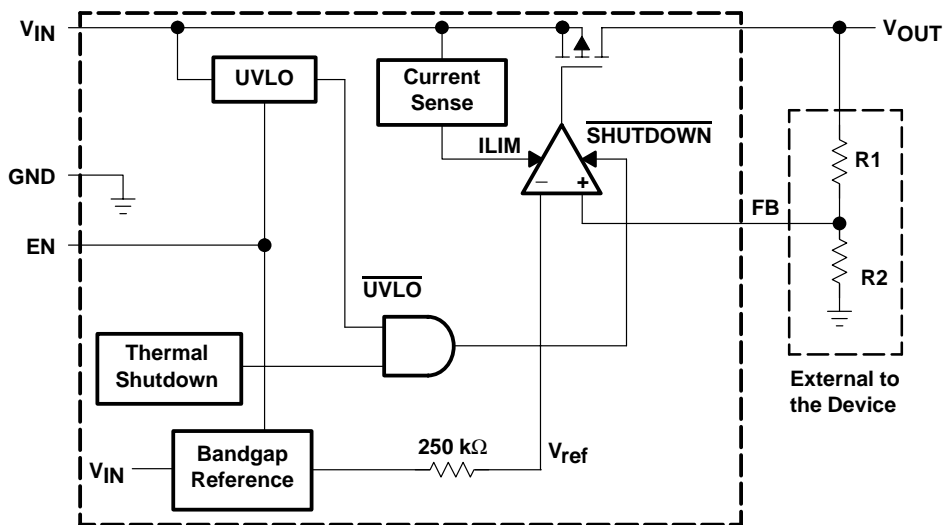

functional block diagram—fixed version

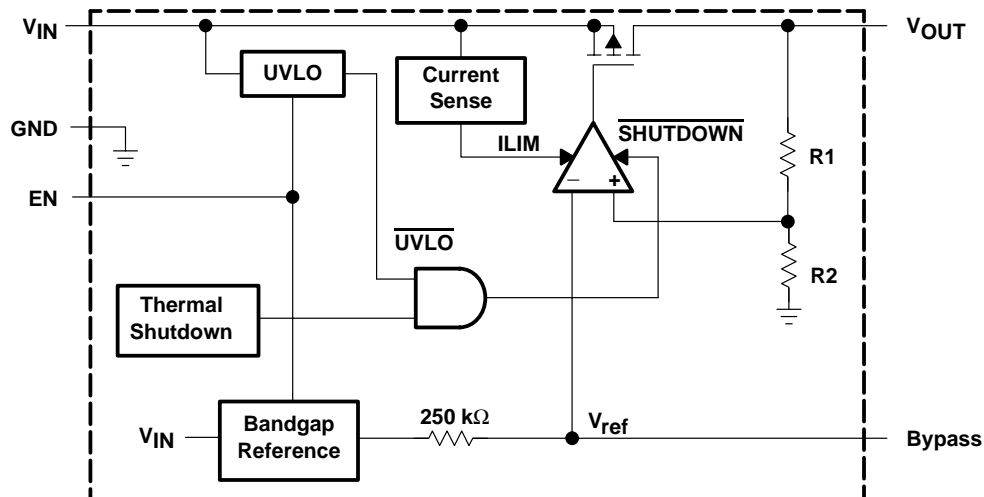

Terminal Functions

TERMINAL NAME	ADJ	FIXED	I/O	DESCRIPTION
BYPASS	NA	5		An external bypass capacitor, connected to this terminal, in conjunction with an internal resistor, creates a low-pass filter to further reduce regulator noise.
EN	1	1	I	The EN terminal is an input which enables or shuts down the device. When EN goes to a logic high, the device will be enabled. When the device goes to a logic low, the device will be in shutdown mode.
FB	5	N/A	I	This terminal is the feedback input voltage for the adjustable device.
GND	3	3		Regulator ground
V _{IN}	2	2	I	The V _{IN} terminal is the input to the device.
V _{OUT}	4	4	O	The V _{OUT} terminal is the regulated output of the device.

TYPICAL CHARACTERISTICS

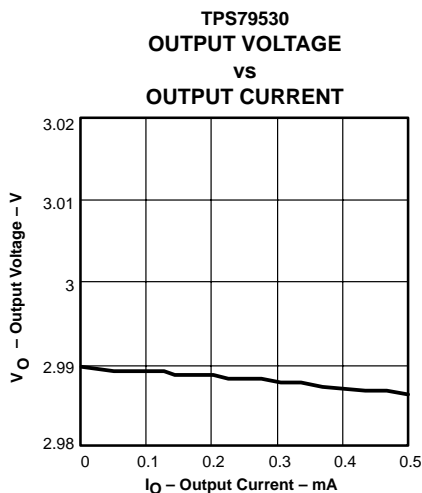

Figure 1

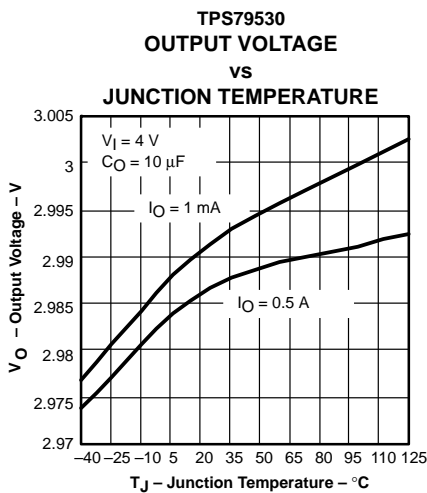

Figure 2

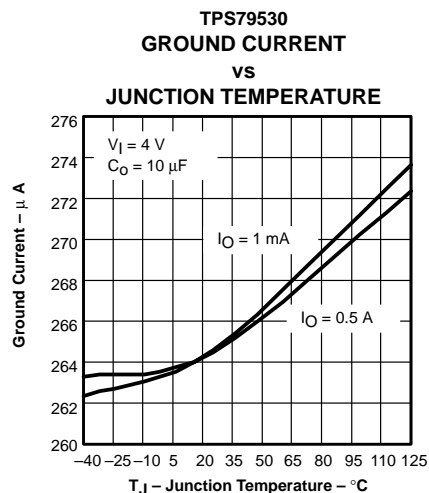

Figure 3

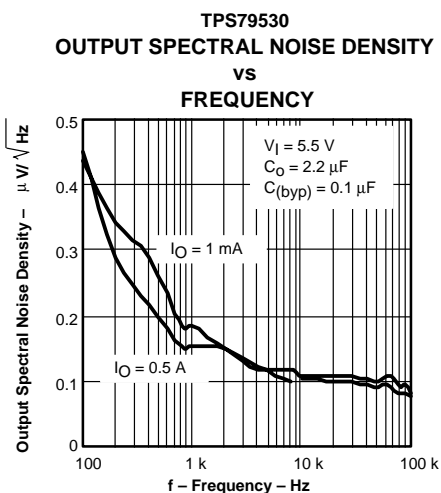

Figure 4

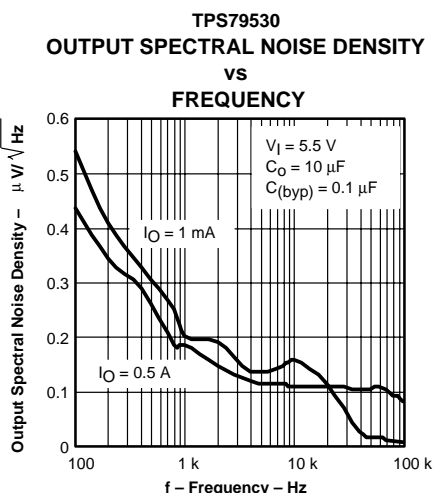

Figure 5

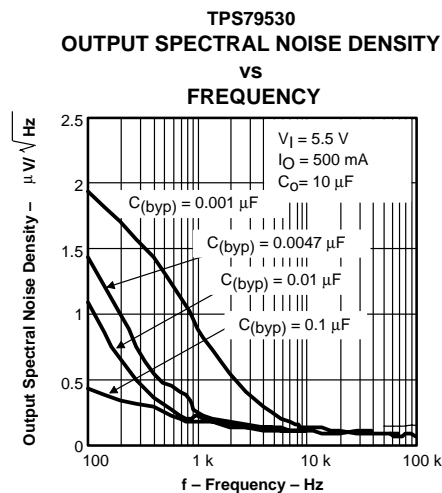

Figure 6

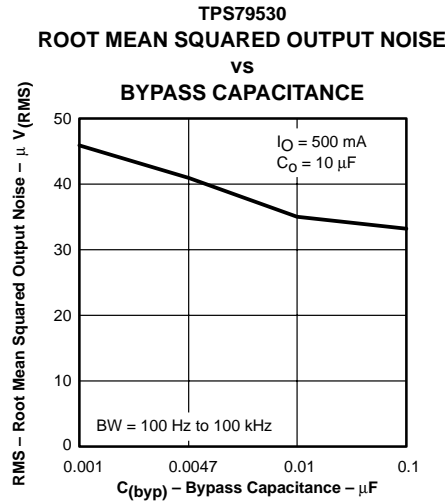

Figure 7

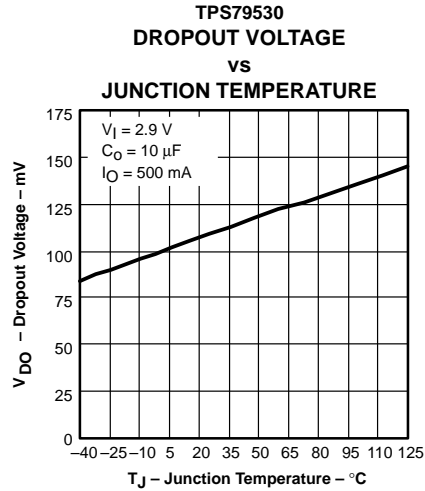

Figure 8

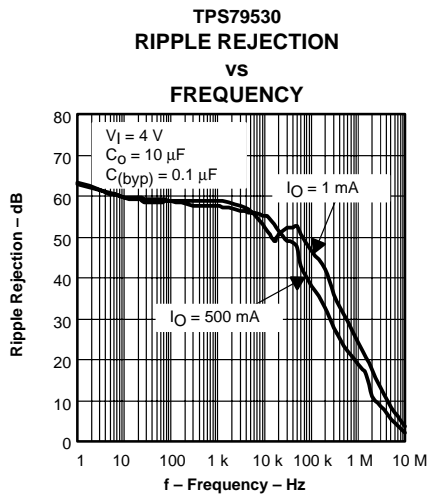

Figure 9

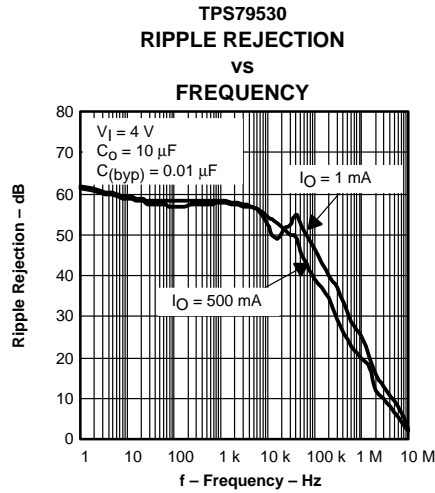

Figure 10

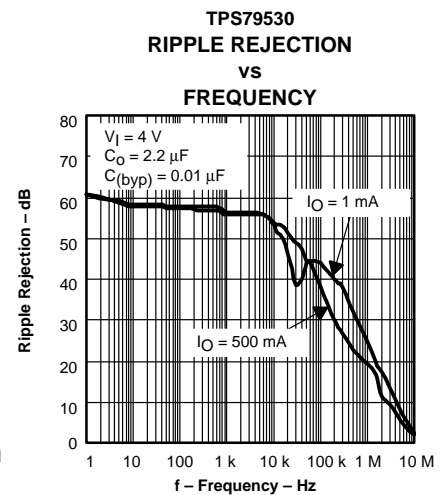

Figure 11

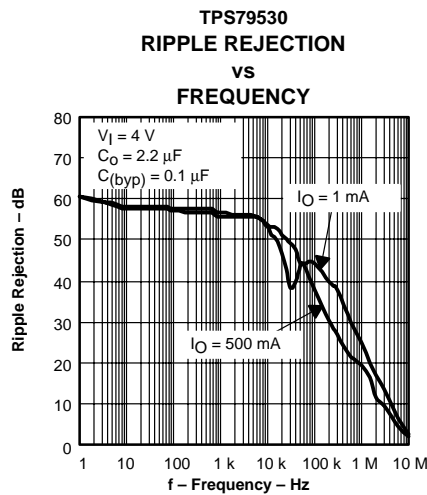

Figure 12

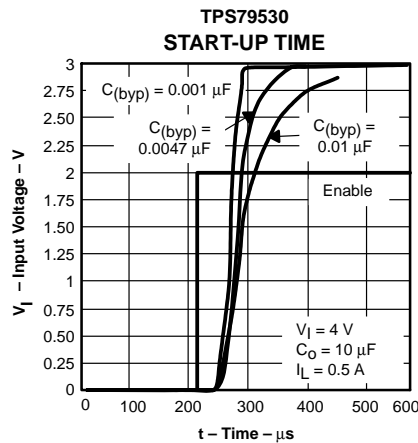

Figure 13

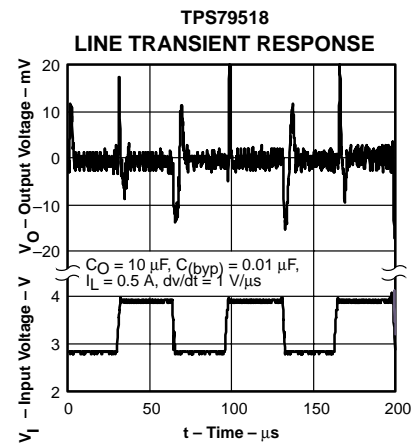

Figure 14

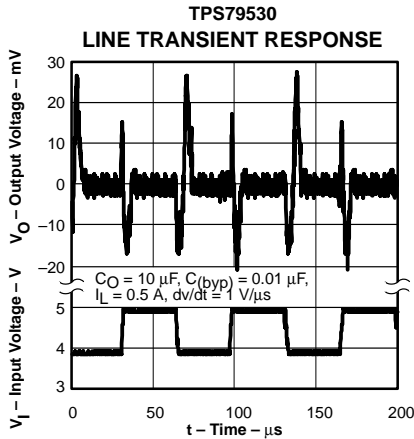

Figure 15

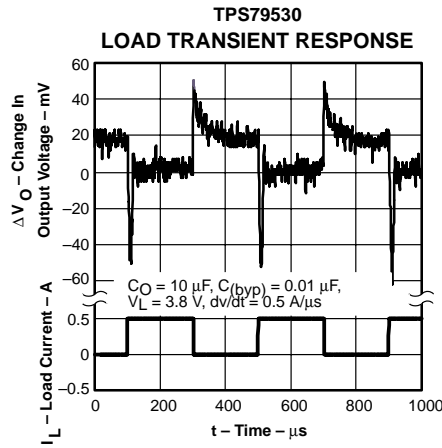

Figure 16

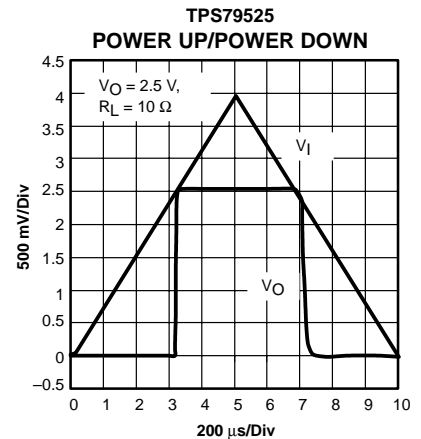

Figure 17

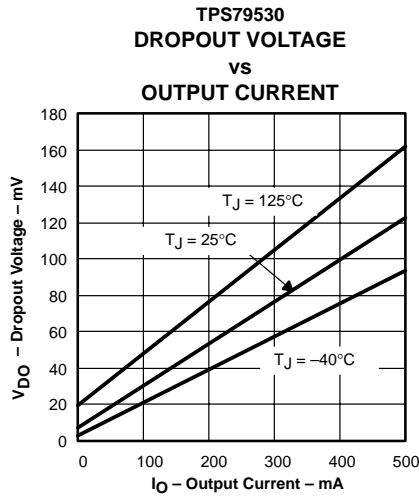

Figure 18

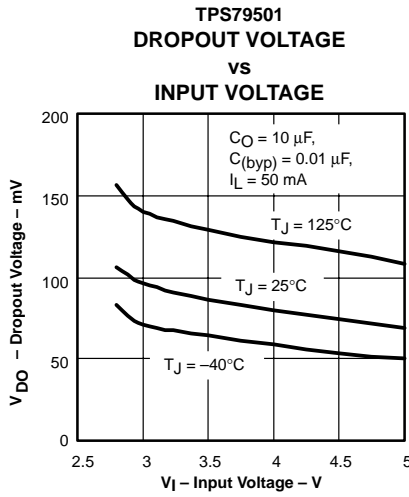

Figure 19

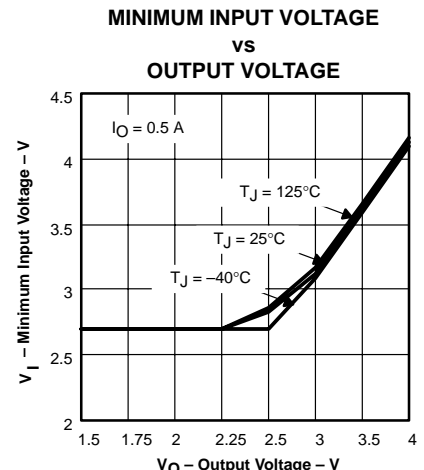

Figure 20

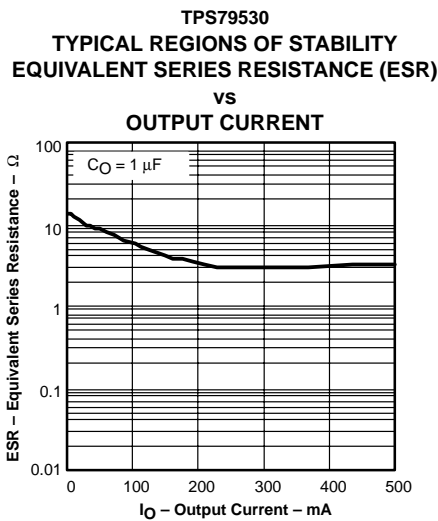

Figure 21

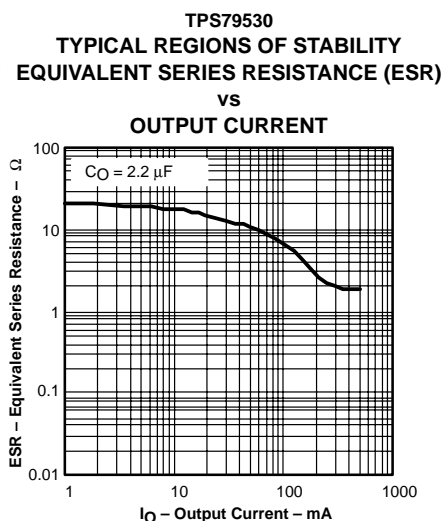

Figure 22

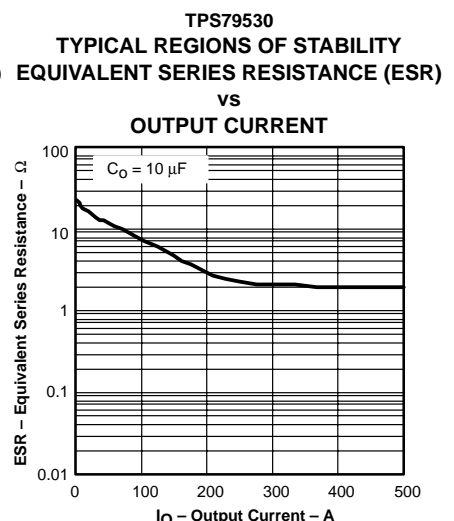

Figure 23

APPLICATION INFORMATION

The TPS795xx family of low-dropout (LDO) regulators has been optimized for use in noise-sensitive battery-operated equipment. The device features extremely low dropout voltages, high PSRR, ultralow output noise, low quiescent current (265 μA typically), and enable input to reduce supply currents to less than 1 μA when the regulator is turned off.

A typical application circuit is shown in Figure 24.

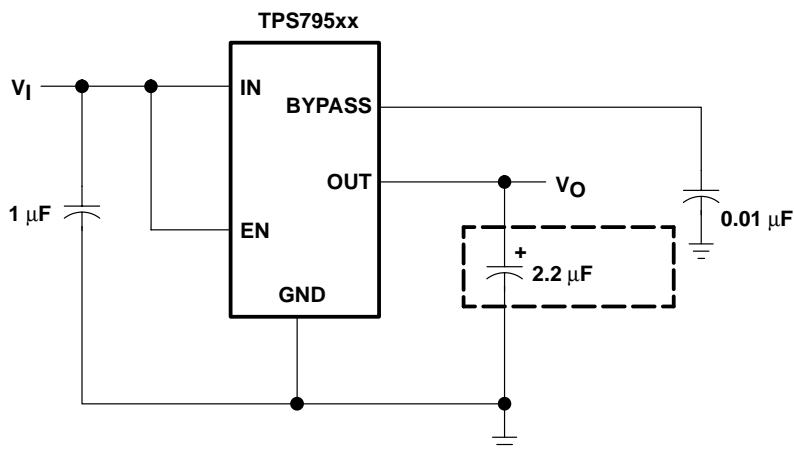

Figure 24. Typical Application Circuit

external capacitor requirements

A 1- μF or larger ceramic input bypass capacitor, connected between IN and GND and located close to the TPS795xx, is required for stability and improves transient response, noise rejection, and ripple rejection. A higher-value electrolytic input capacitor may be necessary if large, fast-rise-time load transients are anticipated and the device is located several inches from the power source.

Like all low dropout regulators, the TPS795xx requires an output capacitor connected between OUT and GND to stabilize the internal control loop. The minimum recommended capacitance is 1 μF . Any 1 μF or larger ceramic capacitor is suitable.

The internal voltage reference is a key source of noise in an LDO regulator. The TPS795xx has a BYPASS pin which is connected to the voltage reference through a 250-k Ω internal resistor. The 250-k Ω internal resistor, in conjunction with an external bypass capacitor connected to the BYPASS pin, creates a low pass filter to reduce the voltage reference noise and, therefore, the noise at the regulator output. In order for the regulator to operate properly, the current flow out of the BYPASS pin must be at a minimum, because any leakage current creates an IR drop across the internal resistor thus creating an output error. Therefore, the bypass capacitor must have minimal leakage current.

For example, the TPS79530 exhibits only 33 μV_{RMS} of output voltage noise using a 0.1- μF ceramic bypass capacitor and a 10- μF ceramic output capacitor. Note that the output starts up slower as the bypass capacitance increases due to the RC time constant at the bypass pin that is created by the internal 250-k Ω resistor and external capacitor.

APPLICATION INFORMATION

board layout recommendation to improve PSRR and noise performance

To improve ac measurements like PSRR, output noise, and transient response, it is recommended that the board be designed with separate ground planes for V_{IN} and V_{OUT} , with each ground plane connected only at the ground pin of the device. In addition, the ground connection for the bypass capacitor should connect directly to the ground pin of the device.

regulator mounting

The tab of the SOT223-5 package is electrically connected to ground. For best thermal performance, the tab of the surface-mount version should be soldered directly to a circuit-board copper area. Increasing the copper area improves heat dissipation.

Although the tab of the SOT223-5 is electrically grounded, it is not intended to carry any current. The copper pad that acts as a heat sink should be isolated from the rest of the circuit to prevent current flow through the device from the tab to the ground pin. Solder pad footprint recommendations for the devices are presented in an application bulletin *Solder Pad Recommendations for Surface-Mount Devices*, literature number AB-132, available from the TI web site (www.ti.com).

programming the TPS79501 adjustable LDO regulator

The output voltage of the TPS79501 adjustable regulator is programmed using an external resistor divider as shown in Figure 25. The output voltage is calculated using:

$$V_O = V_{ref} \times \left(1 + \frac{R1}{R2}\right) \quad (1)$$

where

$$V_{ref} = 1.2246 \text{ V typ (the internal reference voltage)}$$

Resistors R1 and R2 should be chosen for approximately 40- μ A divider current. Lower value resistors can be used for improved noise performance, but the device wastes more power. Higher values should be avoided, as leakage current at FB increases the output voltage error. The recommended design procedure is to choose $R2 = 30.1 \text{ k}\Omega$ to set the divider current at 40 μ A, $C1 = 15 \text{ pF}$ for stability, and then calculate R1 using:

$$R1 = \left(\frac{V_O}{V_{ref}} - 1\right) \times R2 \quad (2)$$

In order to improve the stability of the adjustable version, it is suggested that a small compensation capacitor be placed between OUT and FB. The approximate value of this capacitor can be calculated as:

$$C1 = \frac{(3 \times 10^{-7}) \times (R1 + R2)}{(R1 \times R2)} \quad (3)$$

The suggested value of this capacitor for several resistor ratios is shown in the table below. If this capacitor is not used (such as in a unity-gain configuration) then the minimum recommended output capacitor is 2.2 μ F instead of 1 μ F.

APPLICATION INFORMATION

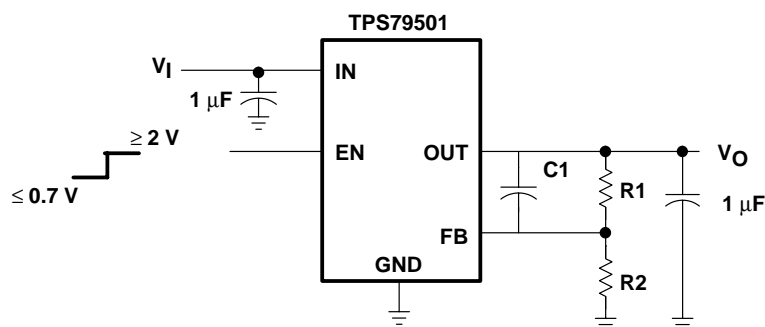

OUTPUT VOLTAGE PROGRAMMING GUIDE

OUTPUT VOLTAGE	R1	R2	C1
1.8 V	14.0 kΩ	30.1 kΩ	22 pF
3.6 V	61.9 kΩ	30.1 kΩ	15 pF

Figure 25. TPS79501 Adjustable LDO Regulator Programming

regulator protection

The TPS795xx PMOS-pass transistor has a built-in back diode that conducts reverse current when the input voltage drops below the output voltage (e.g., during power down). Current is conducted from the output to the input and is not internally limited. If extended reverse voltage operation is anticipated, external limiting might be appropriate.

The TPS795xx features internal current limiting and thermal protection. During normal operation, the TPS795xx limits output current to approximately 2.8 A. When current limiting engages, the output voltage scales back linearly until the overcurrent condition ends. While current limiting is designed to prevent gross device failure, care should be taken not to exceed the power dissipation ratings of the package. If the temperature of the device exceeds approximately 165°C, thermal-protection circuitry shuts it down. Once the device has cooled down to below approximately 140°C, regulator operation resumes.

THERMAL INFORMATION

The amount of heat that an LDO linear regulator generates is directly proportional to the amount of power it dissipates during operation. All integrated circuits have a maximum allowable junction temperature (T_{Jmax}) above which normal operation is not assured. A system designer must design the operating environment so that the operating junction temperature (T_J) does not exceed the maximum junction temperature (T_{Jmax}). The two main environmental variables that a designer can use to improve thermal performance are air flow and external heatsinks. The purpose of this information is to aid the designer in determining the proper operating environment for a linear regulator that is operating at a specific power level.

In general, the maximum expected power ($P_{D(max)}$) consumed by a linear regulator is computed as:

$$P_{Dmax} = (V_{I(avg)} - V_{O(avg)}) \times I_{O(avg)} + V_{I(avg)} \times I_{(Q)} \quad (4)$$

where

$V_{I(avg)}$ is the average input voltage.

$V_{O(avg)}$ is the average output voltage.

$I_{O(avg)}$ is the average output current.

$I_{(Q)}$ is the quiescent current.

For most TI LDO regulators, the quiescent current is insignificant compared to the average output current; therefore, the term $V_{I(avg)} \times I_{(Q)}$ can be neglected. The operating junction temperature is computed by adding the ambient temperature (T_A) and the increase in temperature due to the regulator's power dissipation. The temperature rise is computed by multiplying the maximum expected power dissipation by the sum of the thermal resistances between the junction and the case ($R_{\theta JC}$), the case to heatsink ($R_{\theta CS}$), and the heatsink to ambient ($R_{\theta SA}$). Thermal resistances are measures of how effectively an object dissipates heat. Typically, the larger the device, the more surface area available for power dissipation and the lower the object's thermal resistance.

Figure 26 illustrates these thermal resistances for (a) a SOT223 package mounted in a JEDEC low-K board.,

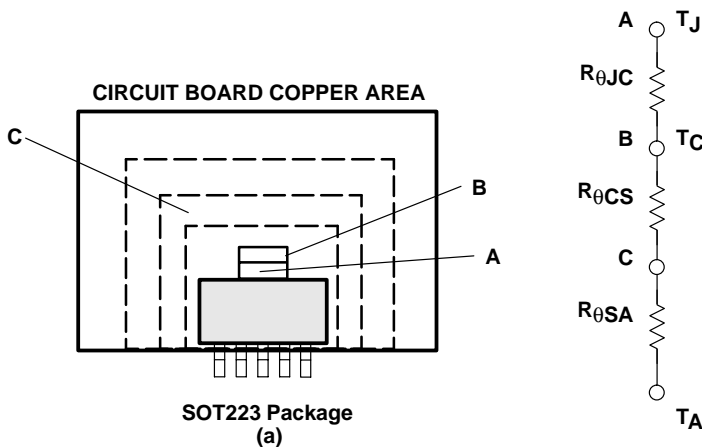

Figure 26. Thermal Resistances

THERMAL INFORMATION

Equation 5 summarizes the computation:

$$T_J = T_A + P_{D\max} \times (R_{\theta JC} + R_{\theta CS} + R_{\theta SA}) \quad (5)$$

The $R_{\theta JC}$ is specific to each regulator as determined by its package, lead frame, and die size provided in the regulator's data sheet. The $R_{\theta SA}$ is a function of the type and size of heatsink. For example, *black body radiator* type heatsinks can have $R_{\theta CS}$ values ranging from 5°C/W for very large heatsinks to 50°C/W for very small heatsinks. The $R_{\theta CS}$ is a function of how the package is attached to the heatsink. For example, if a thermal compound is used to attach a heatsink to a SOT223 package, $R_{\theta CS}$ of 1°C/W is reasonable.

Even if no external *black body radiator* type heatsink is attached to the package, the board on which the regulator is mounted provides some heatsinking through the pin solder connections. Some packages, like the DPAK and SOT223 packages, use a copper plane underneath the package or the circuit board's ground plane for additional heatsinking to improve their thermal performance. Computer aided thermal modeling can be used to compute very accurate approximations of an integrated circuit's thermal performance in different operating environments (e.g., different types of circuit boards, different types and sizes of heatsinks, and different air flows, etc.). Using these models, the three thermal resistances can be combined into one thermal resistance between junction and ambient ($R_{\theta JA}$). This $R_{\theta JA}$ is valid only for the specific operating environment used in the computer model.

Equation 5 simplifies into equation 6:

$$T_J = T_A + P_{D\max} \times R_{\theta JA} \quad (6)$$

Rearranging equation 6 gives equation 7:

$$R_{\theta JA} = \frac{T_J - T_A}{P_{D\max}} \quad (7)$$

Using equation 6 and the computer model generated curves shown in Figure 27, a designer can quickly compute the required heatsink thermal resistance/board area for a given ambient temperature, power dissipation, and operating environment.

SOT223 power dissipation

The SOT223 package provides an effective means of managing power dissipation in surface mount applications. The SOT223 package dimensions are provided in the *Mechanical Data* section at the end of the data sheet. The addition of a copper plane directly underneath the SOT223 package enhances the thermal performance of the package.

To illustrate, the TPS79525 in a SOT223 package was chosen. For this example, the average input voltage is 3.3 V, the output voltage is 2.5 V, the average output current is 1 A, the ambient temperature 55°C, no air flow is present, and the operating environment is the same as documented below. Neglecting the quiescent current, the maximum average power is:

$$P_{D\max} = (3.3 - 2.5) \text{ V} \times 1 \text{ A} = 800 \text{ mW} \quad (8)$$

Substituting T_{Jmax} for T_J into equation 4 gives equation 9:

$$R_{\theta JA \max} = (125 - 55)^\circ\text{C}/800 \text{ mW} = 87.5^\circ\text{C}/\text{W} \quad (9)$$

From Figure 27, $R_{\theta JA}$ vs PCB Copper Area, the ground plane needs to be 0.55 in² for the part to dissipate 800 mW. The operating environment used to construct Figure 27 consisted of a board with 1 oz. copper planes. The package is soldered to a 1 oz. copper pad on the top of the board. The pad is tied through thermal vias to the 1 oz. ground plane.

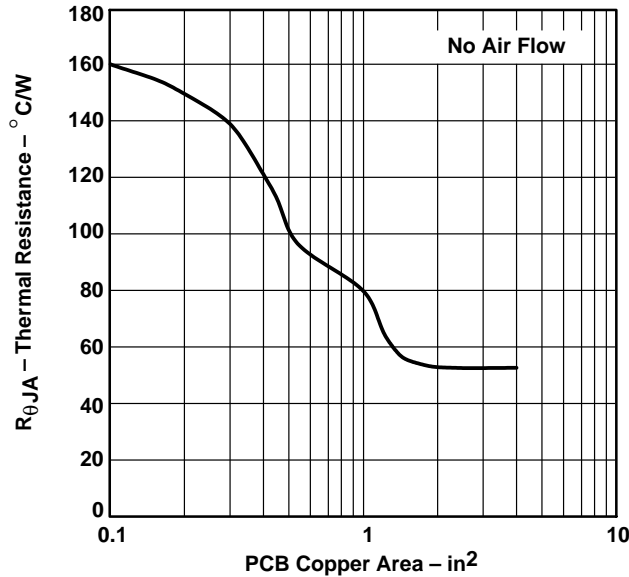

Figure 27. SOT223 Thermal Resistance vs PCB Copper Area

From the data in Figure 27 and rearranging equation 6, the maximum power dissipation for a different ground plane area and a specific ambient temperature can be computed (see Figure 28).

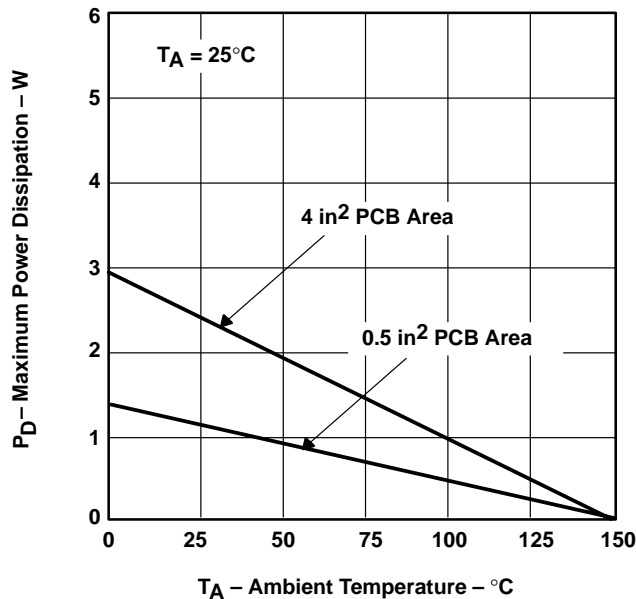
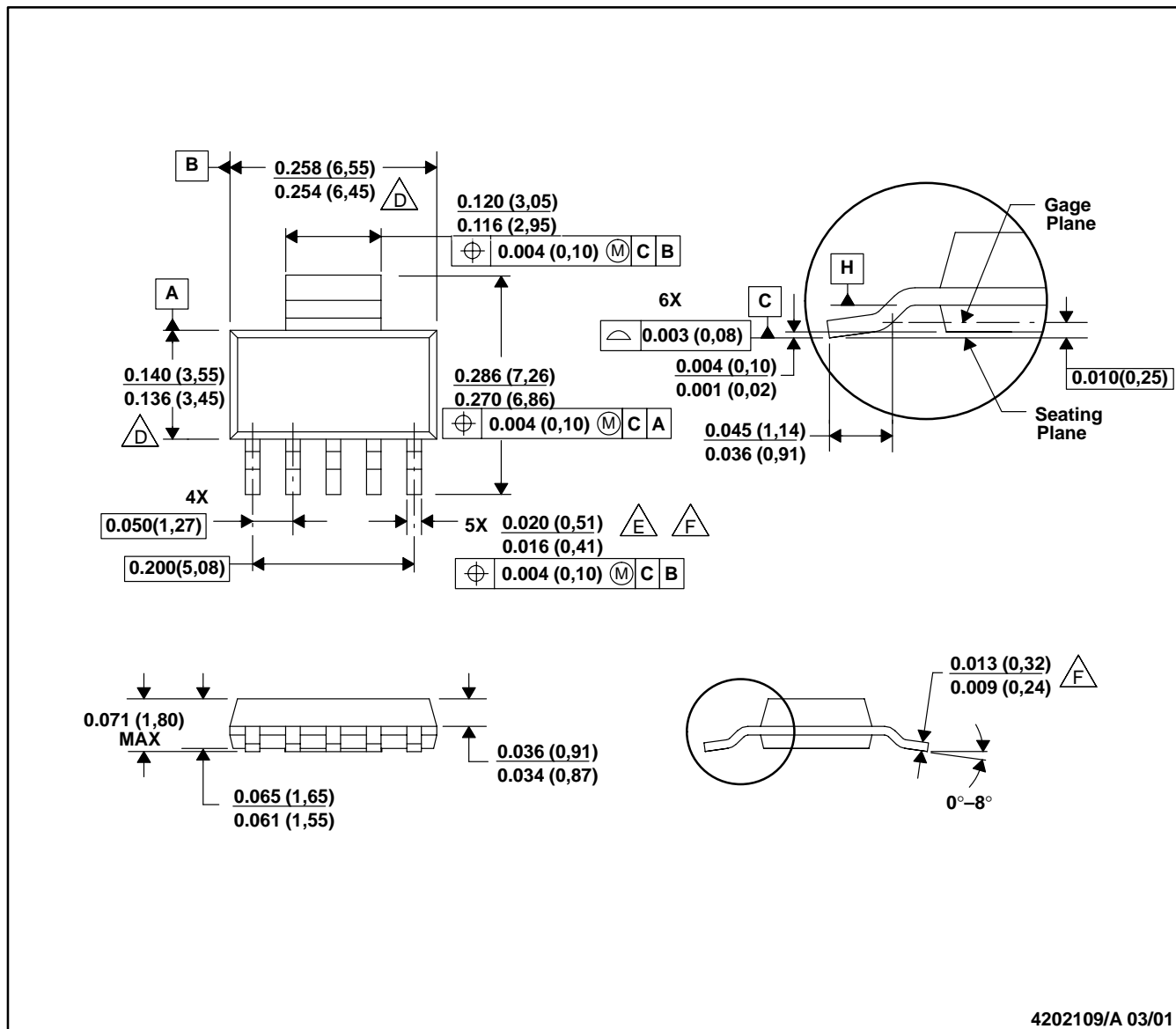

Figure 28. SOT223 Maximum Power Dissipation vs Ambient Temperature

MECHANICAL DATA

DCQ (R-PDSO-G6)

PLASTIC SMALL-OUTLINE



4202109/A 03/01

- NOTES:
- A. All linear dimensions are in inches (millimeters).
 - B. This drawing is subject to change without notice.
 - C. Controlling dimension in inches
 - D. Body length and width dimensions are determined at the outermost extremes of the plastic body exclusive of mold flash, tie bar burrs, gate burrs, and interlead flash, but including any mismatch between the top and the bottom of the plastic body.
 - E. Lead width dimension does not include dambar protrusion.
 - F. Lead width and thickness dimensions apply to solder plated leads.
 - G. Interlead flash allow 0.008 inch max.
 - H. Gate burr/protrusion max. 0.006 inch.
 - I. Datums A and B are to be determined at Datum H.
 - J. Package dimensions per JEDEC outline drawing TO-261, issue B, dated Feb. 1999. This variation is not yet included.

IMPORTANT NOTICE

Texas Instruments Incorporated and its subsidiaries (TI) reserve the right to make corrections, modifications, enhancements, improvements, and other changes to its products and services at any time and to discontinue any product or service without notice. Customers should obtain the latest relevant information before placing orders and should verify that such information is current and complete. All products are sold subject to TI's terms and conditions of sale supplied at the time of order acknowledgment.

TI warrants performance of its hardware products to the specifications applicable at the time of sale in accordance with TI's standard warranty. Testing and other quality control techniques are used to the extent TI deems necessary to support this warranty. Except where mandated by government requirements, testing of all parameters of each product is not necessarily performed.

TI assumes no liability for applications assistance or customer product design. Customers are responsible for their products and applications using TI components. To minimize the risks associated with customer products and applications, customers should provide adequate design and operating safeguards.

TI does not warrant or represent that any license, either express or implied, is granted under any TI patent right, copyright, mask work right, or other TI intellectual property right relating to any combination, machine, or process in which TI products or services are used. Information published by TI regarding third-party products or services does not constitute a license from TI to use such products or services or a warranty or endorsement thereof. Use of such information may require a license from a third party under the patents or other intellectual property of the third party, or a license from TI under the patents or other intellectual property of TI.

Reproduction of information in TI data books or data sheets is permissible only if reproduction is without alteration and is accompanied by all associated warranties, conditions, limitations, and notices. Reproduction of this information with alteration is an unfair and deceptive business practice. TI is not responsible or liable for such altered documentation.

Resale of TI products or services with statements different from or beyond the parameters stated by TI for that product or service voids all express and any implied warranties for the associated TI product or service and is an unfair and deceptive business practice. TI is not responsible or liable for any such statements.

Mailing Address:

Texas Instruments
Post Office Box 655303
Dallas, Texas 75265