

- **Output Swing Includes Both Supply Rails**
- **Low Noise . . . 21 nV/√Hz Typ at f = 1 kHz**
- **Low Input Bias Current . . . 1 pA Typ**
- **Very Low Power . . . 13 μA Per Channel Typ**
- **Common-Mode Input Voltage Range Includes Negative Rail**
- **Wide Supply Voltage Range 2.7 V to 10 V**
- **Available in the SOT-23 Package**
- **Macromodel Included**

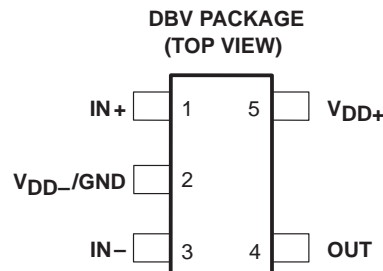

description

The TLV2211 is a single operational amplifier manufactured using the Texas Instruments Advanced LinCMOS™ process. These devices are optimized and fully specified for single-supply 3-V and 5-V operation. For this low-voltage operation combined with micropower dissipation levels, the input noise voltage performance has been dramatically improved using optimized design techniques for CMOS-type amplifiers. Another added benefit is that these amplifiers exhibit rail-to-rail output swing. The output dynamic range can be extended using the TLV2211 with loads referenced midway between the rails. The common-mode input voltage range is wider than typical standard CMOS-type amplifiers. To take advantage of this improvement in performance and to make this device available for a wider range of applications, V_{ICR} is specified with a larger maximum input offset voltage test limit of ± 5 mV, allowing a minimum of 0 to 2-V common-mode input voltage range for a 3-V power supply.

AVAILABLE OPTIONS

| T_A | V_{IOmax} AT 25°C | PACKAGED DEVICES | SYMBOL | CHIP FORM (Y) |
|---------------|---------------------|------------------|--------|---------------|
| | | SOT-23 (DBV)† | | |
| 0°C to 70°C | 3 mV | TLV2211CDBV | VACC | TLV2211Y |
| -40°C to 85°C | 3 mV | TLV2211IDBV | VACI | |

† The DBV package available in tape and reel only.

The Advanced LinCMOS process uses a silicon-gate technology to obtain input offset voltage stability with temperature and time that far exceeds that obtainable using metal-gate technology. This technology also makes possible input-impedance levels that meet or exceed levels offered by top-gate JFET and expensive dielectric-isolated devices.

The TLV2211, exhibiting high input impedance and low noise, is excellent for small-signal conditioning for high-impedance sources such as piezoelectric transducers. Because of the low power dissipation levels combined with 3-V operation, these devices work well in hand-held monitoring and remote-sensing applications. In addition, the rail-to-rail output feature with single or split supplies makes these devices excellent choices when interfacing directly to analog-to-digital converters (ADCs). All of these features combined with its temperature performance make the TLV2211 ideal for remote pressure sensors, temperature control, active voltage-resistive (VR) sensors, accelerometers, hand-held metering, and many other applications.



Please be aware that an important notice concerning availability, standard warranty, and use in critical applications of Texas Instruments semiconductor products and disclaimers thereto appears at the end of this data sheet.

Advanced LinCMOS is a trademark of Texas Instruments Incorporated.

PRODUCTION DATA information is current as of publication date. Products conform to specifications per the terms of Texas Instruments standard warranty. Production processing does not necessarily include testing of all parameters.

**TEXAS
INSTRUMENTS**

POST OFFICE BOX 655303 • DALLAS, TEXAS 75265

Copyright © 1997, Texas Instruments Incorporated

TLV2211, TLV2211Y
Advanced LinCMOS™ RAIL-TO-RAIL
MICROPOWER SINGLE OPERATIONAL AMPLIFIERS
SLOS156B – MAY 1996 – REVISED JANUARY 1997

description (continued)

The device inputs and outputs are designed to withstand a 100-mA surge current without sustaining latch-up. In addition, internal ESD-protection circuits prevent functional failures up to 2000 V as tested under MIL-PRF-38535; however, care should be exercised when handling these devices as exposure to ESD may result in degradation of the device parametric performance. Additional care should be exercised to prevent V_{DD+} supply-line transients under powered conditions. Transients of greater than 20 V can trigger the ESD-protection structure, inducing a low-impedance path to V_{DD-}/GND . Should this condition occur, the sustained current supplied to the device must be limited to 100 mA or less. Failure to do so could result in a latched condition and device failure.



TLV2211Y chip information

This chip, when properly assembled, displays characteristics similar to the TLV2211C. Thermal compression or ultrasonic bonding may be used on the doped-aluminum bonding pads. This chip may be mounted with conductive epoxy or a gold-silicon preform.

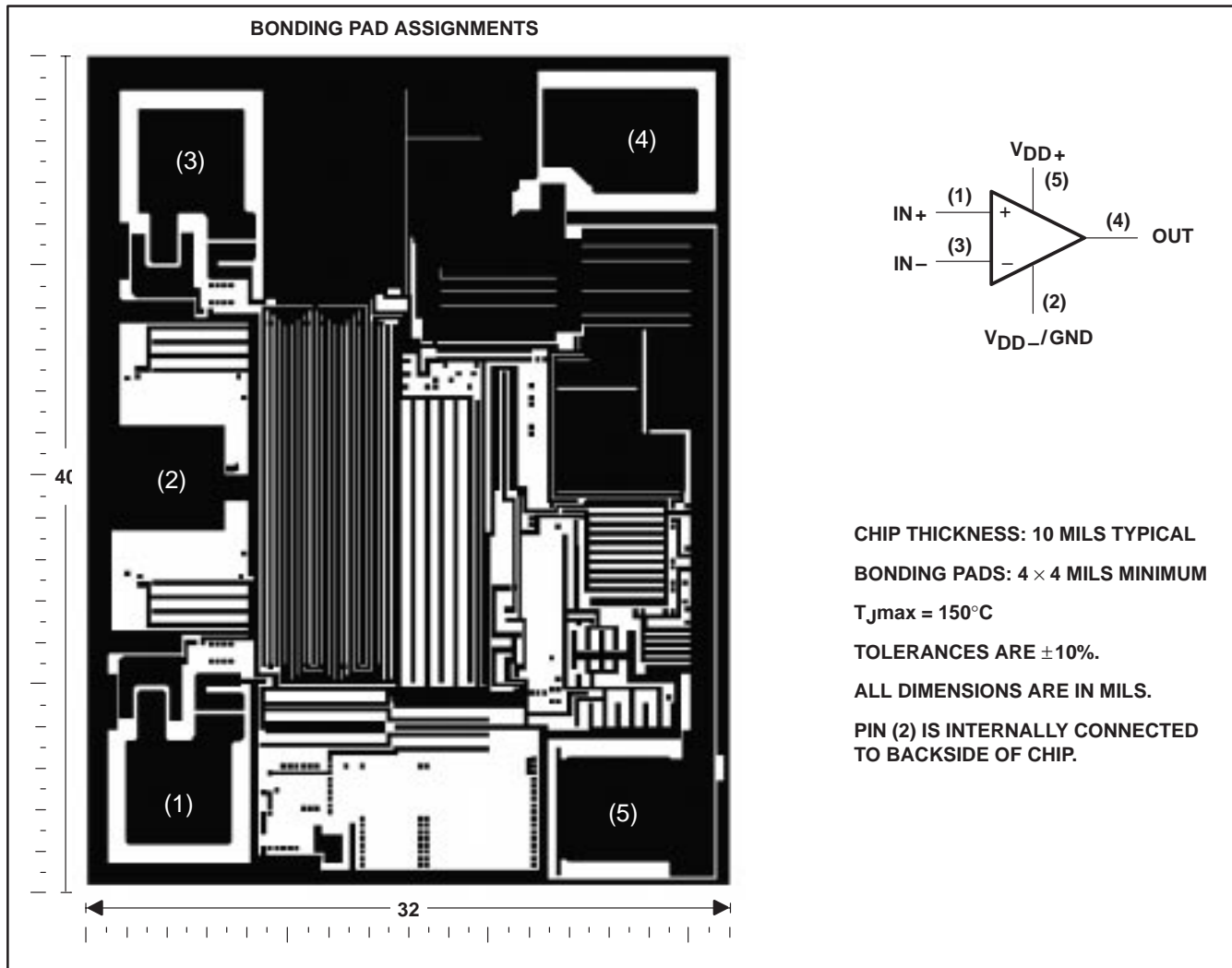

TLV2211, TLV2211Y

Advanced LinCMOS™ RAIL-TO-RAIL
MICROPOWER SINGLE OPERATIONAL AMPLIFIERS

SLOS156B – MAY 1996 – REVISED JANUARY 1997

equivalent schematic

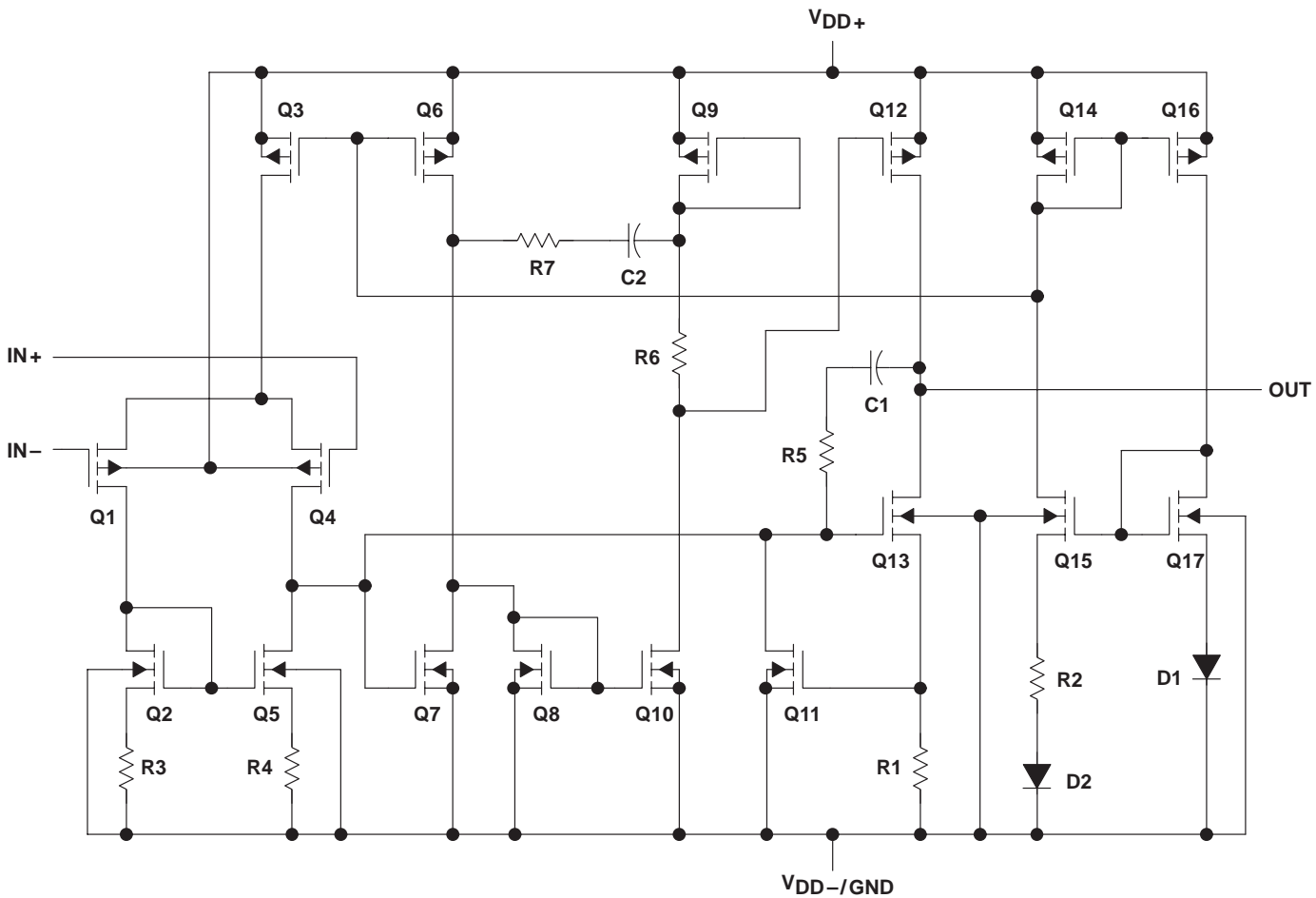

| COMPONENT COUNT† | |
|------------------|----|
| Transistors | 23 |
| Diodes | 6 |
| Resistors | 11 |
| Capacitors | 2 |

† Includes both amplifiers and all ESD, bias, and trim circuitry

absolute maximum ratings over operating free-air temperature range (unless otherwise noted)†

| | |
|---|------------------------------|
| Supply voltage, V_{DD} (see Note 1) | 12 V |
| Differential input voltage, V_{ID} (see Note 2) | $\pm V_{DD}$ |
| Input voltage range, V_I (any input, see Note 1) | –0.3 V to V_{DD} |
| Input current, I_I (each input) | ± 5 mA |
| Output current, I_O | ± 50 mA |
| Total current into V_{DD+} | ± 50 mA |
| Total current out of V_{DD-} | ± 50 mA |
| Duration of short-circuit current (at or below) 25°C (see Note 3) | unlimited |
| Continuous total power dissipation | See Dissipation Rating Table |
| Operating free-air temperature range, T_A : TLV2211C | 0°C to 70°C |
| TLV2211I | –40°C to 85°C |
| Storage temperature range, T_{stg} | –65°C to 150°C |
| Lead temperature 1,6 mm (1/16 inch) from case for 10 seconds: DBV package | 260°C |

† Stresses beyond those listed under “absolute maximum ratings” may cause permanent damage to the device. These are stress ratings only, and functional operation of the device at these or any other conditions beyond those indicated under “recommended operating conditions” is not implied. Exposure to absolute-maximum-rated conditions for extended periods may affect device reliability.

- NOTES:
1. All voltage values, except differential voltages, are with respect to V_{DD-} .
 2. Differential voltages are at the noninverting input with respect to the inverting input. Excessive current flows when input is brought below $V_{DD-} - 0.3$ V.
 3. The output may be shorted to either supply. Temperature and/or supply voltages must be limited to ensure that the maximum dissipation rating is not exceeded.

DISSIPATION RATING TABLE

| PACKAGE | $T_A \leq 25^\circ\text{C}$ POWER RATING | DERATING FACTOR ABOVE $T_A = 25^\circ\text{C}$ | $T_A = 70^\circ\text{C}$ POWER RATING | $T_A = 85^\circ\text{C}$ POWER RATING |
|---------|---|---|--|--|
| DBV | 150 mW | 1.2 mW/°C | 96 mW | 78 mW |

recommended operating conditions

| | TLV2211C | | TLV2211I | | UNIT |
|---------------------------------------|-----------|-----------------|-----------|-----------------|------|
| | MIN | MAX | MIN | MAX | |
| Supply voltage, V_{DD} (see Note 1) | 2.7 | 10 | 2.7 | 10 | V |
| Input voltage range, V_I | V_{DD-} | $V_{DD+} - 1.3$ | V_{DD-} | $V_{DD+} - 1.3$ | V |
| Common-mode input voltage, V_{IC} | V_{DD-} | $V_{DD+} - 1.3$ | V_{DD-} | $V_{DD+} - 1.3$ | V |
| Operating free-air temperature, T_A | 0 | 70 | –40 | 85 | °C |

NOTE 1: All voltage values, except differential voltages, are with respect to V_{DD-} .

TLV2211, TLV2211Y
Advanced LinCMOS™ RAIL-TO-RAIL
MICROPOWER SINGLE OPERATIONAL AMPLIFIERS

SLOS156B – MAY 1996 – REVISED JANUARY 1997

electrical characteristics at specified free-air temperature, $V_{DD} = 3\text{ V}$ (unless otherwise noted)

| PARAMETER | TEST CONDITIONS | T_A † | TLV2211C | | | TLV2211I | | | UNIT |
|--|---|------------|-----------------------------|------------|-----------------------|-----------|---------------|------|------------------------------|
| | | | MIN | TYP | MAX | MIN | TYP | MAX | |
| V_{IO} Input offset voltage | $V_{DD\pm} = \pm 1.5\text{ V}$, $V_O = 0$, $V_{IC} = 0$, $R_S = 50\ \Omega$ | Full range | 0.47 3 | | | 0.47 3000 | | | mV |
| α_{VIO} Temperature coefficient of input offset voltage | | | 1 | | | 1 | | | $\mu\text{V}/^\circ\text{C}$ |
| Input offset voltage long-term drift (see Note 4) | | 25°C | 0.003 | | | 0.003 | | | $\mu\text{V}/\text{mo}$ |
| I_{IO} Input offset current | | Full range | 0.5 150 | | | 0.5 150 | | | pA |
| I_{IB} Input bias current | | Full range | 1 150 | | | 1 150 | | | pA |
| V_{ICR} Common-mode input voltage range | $ V_{IO} \leq 5\text{ mV}$, $R_S = 50\ \Omega$ | 25°C | 0 to 2 -0.3 to 2.2 | | 0 to 2 -0.3 to 2.2 | | V | | |
| | | Full range | 0 to 1.7 | | 0 to 1.7 | | | | |
| V_{OH} High-level output voltage | $I_{OH} = -100\ \mu\text{A}$ $I_{OH} = -250\ \mu\text{A}$ | 25°C | 2.94 | | | 2.94 | | | V |
| | | 25°C | 2.85 | | | 2.85 | | | |
| | | Full range | 2.5 | | | 2.5 | | | |
| V_{OL} Low-level output voltage | $V_{IC} = 1.5\text{ V}$, $I_{OL} = 50\ \mu\text{A}$ $V_{IC} = 1.5\text{ V}$, $I_{OL} = 500\ \mu\text{A}$ | 25°C | 15 | | | 15 | | | mV |
| | | 25°C | 150 | | | 150 | | | |
| | | Full range | 500 | | | 500 | | | |
| A_{VD} Large-signal differential voltage amplification | $V_{IC} = 1.5\text{ V}$, $V_O = 1\text{ V to } 2\text{ V}$ | 25°C | $R_L = 10\text{ k}\Omega$ ‡ | 3 7 | | 3 7 | | V/mV | |
| | | | | Full range | 1 | | 1 | | |
| | | 25°C | $R_L = 1\text{ M}\Omega$ ‡ | 600 | | 600 | | | |
| $r_{i(d)}$ Differential input resistance | | 25°C | 10^{12} | | | 10^{12} | | | Ω |
| $r_{i(c)}$ Common-mode input resistance | | 25°C | 10^{12} | | | 10^{12} | | | Ω |
| $C_{i(c)}$ Common-mode input capacitance | $f = 10\text{ kHz}$, | 25°C | 5 | | | 5 | | | pF |
| z_o Closed-loop output impedance | $f = 7\text{ kHz}$, $A_V = 1$ | 25°C | 200 | | | 200 | | | Ω |
| CMRR Common-mode rejection ratio | $V_{IC} = 0\text{ to } 1.7\text{ V}$, $R_S = 50\ \Omega$, $V_O = 1.5\text{ V}$ | 25°C | 65 83 | | 65 83 | | dB | | |
| | | Full range | 60 | | 60 | | | | |
| k_{SVR} Supply voltage rejection ratio ($\Delta V_{DD} / \Delta V_{IO}$) | $V_{DD} = 2.7\text{ V to } 8\text{ V}$, No load, $V_{IC} = V_{DD}/2$ | 25°C | 80 95 | | 80 95 | | dB | | |
| | | Full range | 80 | | 80 | | | | |
| I_{DD} Supply current | $V_O = 1.5\text{ V}$, No load | 25°C | 11 25 | | 11 25 | | μA | | |
| | | Full range | 30 | | 30 | | | | |

† Full range for the TLV2211C is 0°C to 70°C. Full range for the TLV2211I is -40°C to 85°C.

‡ Referenced to 1.5 V

NOTE 4: Typical values are based on the input offset voltage shift observed through 500 hours of operating life test at $T_A = 150^\circ\text{C}$ extrapolated to $T_A = 25^\circ\text{C}$ using the Arrhenius equation and assuming an activation energy of 0.96 eV.



operating characteristics at specified free-air temperature, $V_{DD} = 3\text{ V}$ (unless otherwise noted)

| PARAMETER | TEST CONDITIONS | T_A † | TLV2211C | | | TLV2211I | | | UNIT | |
|-------------|---|---|----------|-------|-----|----------|-------|-----|------------------------|----|
| | | | MIN | TYP | MAX | MIN | TYP | MAX | | |
| SR | Slew rate at unity gain $V_O = 1.1\text{ V to }1.9\text{ V}, R_L = 10\text{ k}\Omega^\ddagger, C_L = 100\text{ pF}^\ddagger$ | 25°C | 0.01 | 0.025 | | 0.01 | 0.025 | | V/ μs | |
| | | Full range | 0.005 | | | 0.005 | | | | |
| V_n | Equivalent input noise voltage | f = 10 Hz | 80 | | | 80 | | | nV/ $\sqrt{\text{Hz}}$ | |
| | | f = 1 kHz | 22 | | | 22 | | | | |
| $V_{N(PP)}$ | Peak-to-peak equivalent input noise voltage | f = 0.1 Hz to 1 Hz | 660 | | | 660 | | | μV | |
| | | f = 0.1 Hz to 10 Hz | 880 | | | 880 | | | | |
| I_n | Equivalent input noise current | 25°C | 0.6 | | | 0.6 | | | fA/ $\sqrt{\text{Hz}}$ | |
| | Gain-bandwidth product | f = 10 kHz, $R_L = 10\text{ k}\Omega^\ddagger, C_L = 100\text{ pF}^\ddagger$ | 56 | | | 56 | | | kHz | |
| BOM | Maximum output-swing bandwidth | $V_{O(PP)} = 1\text{ V}, R_L = 10\text{ k}\Omega^\ddagger, A_V = 1, C_L = 100\text{ pF}^\ddagger$ | 7 | | | 7 | | | kHz | |
| ϕ_m | Phase margin at unity gain | $R_L = 10\text{ k}\Omega^\ddagger, C_L = 100\text{ pF}^\ddagger$ | 25°C | 56° | | | 56° | | | |
| | Gain margin | | 25°C | 20 | | | 20 | | | dB |

† Full range is -40°C to 85°C .

‡ Referenced to 1.5 V

TLV2211, TLV2211Y
Advanced LinCMOS™ RAIL-TO-RAIL
MICROPOWER SINGLE OPERATIONAL AMPLIFIERS
 SLOS156B – MAY 1996 – REVISED JANUARY 1997

electrical characteristics at specified free-air temperature, $V_{DD} = 5\text{ V}$ (unless otherwise noted)

| PARAMETER | TEST CONDITIONS | T_A † | TLV2211C | | | TLV2211I | | | UNIT |
|--|---|------------|-----------------------------|-------------|----------|-------------|---------------|-----|------------------------------|
| | | | MIN | TYP | MAX | MIN | TYP | MAX | |
| V_{IO} Input offset voltage | $V_{DD\pm} = \pm 2.5\text{ V}$, $V_O = 0$, $V_{IC} = 0$, $R_S = 50\ \Omega$ | Full range | 0.45 3 | | | 0.45 3 | | | mV |
| α_{VIO} Temperature coefficient of input offset voltage | | | 0.5 | | | 0.5 | | | $\mu\text{V}/^\circ\text{C}$ |
| Input offset voltage long-term drift (see Note 4) | | 25°C | 0.003 | | | 0.003 | | | $\mu\text{V}/\text{mo}$ |
| I_{IO} Input offset current | | 25°C | 0.5 | | | 0.5 | | | pA |
| | | Full range | 150 | | | 150 | | | |
| I_{IB} Input bias current | | 25°C | 1 | | | 1 | | | pA |
| | Full range | 150 | | | 150 | | | | |
| V_{ICR} Common-mode input voltage range | $ V_{IO} \leq 5\text{ mV}$ $R_S = 50\ \Omega$ | 25°C | 0 to 4 | -0.3 to 4.2 | 0 to 4 | -0.3 to 4.2 | V | | |
| | | Full range | 0 to 3.5 | | 0 to 3.5 | | | | |
| V_{OH} High-level output voltage | $I_{OH} = -100\ \mu\text{A}$ $I_{OH} = -250\ \mu\text{A}$ | 25°C | 4.95 | | | 4.95 | | | V |
| | | 25°C | 4.875 | | | 4.875 | | | |
| | | Full range | 4.5 | | | 4.5 | | | |
| V_{OL} Low-level output voltage | $V_{IC} = 2.5\text{ V}$, $I_{OL} = 50\ \mu\text{A}$ $V_{IC} = 2.5\text{ V}$, $I_{OL} = 500\ \mu\text{A}$ | 25°C | 12 | | | 12 | | | mV |
| | | 25°C | 120 | | | 120 | | | |
| | | Full range | 500 | | | 500 | | | |
| A_{VD} Large-signal differential voltage amplification | $V_{IC} = 2.5\text{ V}$, $V_O = 1\text{ V to }4\text{ V}$ | 25°C | $R_L = 10\text{ k}\Omega$ ‡ | | | 6 12 | | | V/mV |
| | | | Full range | | | 3 | | | |
| | | 25°C | $R_L = 1\text{ M}\Omega$ ‡ | | | 800 | | | |
| $r_{i(d)}$ Differential input resistance | | 25°C | 10^{12} | | | 10^{12} | | | Ω |
| $r_{i(c)}$ Common-mode input resistance | | 25°C | 10^{12} | | | 10^{12} | | | Ω |
| $C_{i(c)}$ Common-mode input capacitance | $f = 10\text{ kHz}$, | 25°C | 5 | | | 5 | | | pF |
| z_o Closed-loop output impedance | $f = 7\text{ kHz}$, $A_V = 1$ | 25°C | 200 | | | 200 | | | Ω |
| CMRR Common-mode rejection ratio | $V_{IC} = 0\text{ to }2.7\text{ V}$, $R_S = 50\ \Omega$, $V_O = 2.5\text{ V}$ | 25°C | 70 | 83 | 70 | 83 | dB | | |
| | | Full range | 70 | | | 70 | | | |
| k_{SVR} Supply voltage rejection ratio ($\Delta V_{DD} / \Delta V_{IO}$) | $V_{DD} = 4.4\text{ V to }8\text{ V}$, No load, $V_{IC} = V_{DD}/2$ | 25°C | 80 | 95 | 80 | 95 | dB | | |
| | | Full range | 80 | | | 80 | | | |
| I_{DD} Supply current | $V_O = 2.5\text{ V}$, No load | 25°C | 13 | 25 | 13 | 25 | μA | | |
| | | Full range | 30 | | | 30 | | | |

† Full range for the TLV2211C is 0°C to 70°C. Full range for the TLV2211I is -40°C to 85°C.

‡ Referenced to 1.5 V

NOTE 5: Typical values are based on the input offset voltage shift observed through 500 hours of operating life test at $T_A = 150^\circ\text{C}$ extrapolated to $T_A = 25^\circ\text{C}$ using the Arrhenius equation and assuming an activation energy of 0.96 eV.



operating characteristics at specified free-air temperature, $V_{DD} = 5\text{ V}$ (unless otherwise noted)

| PARAMETER | TEST CONDITIONS | T_A † | TLV2211C | | | TLV2211I | | | UNIT |
|---|--|-------------|----------|-------|-----|----------|-------|-----|------------------------|
| | | | MIN | TYP | MAX | MIN | TYP | MAX | |
| SR Slew rate at unity gain | $V_O = 1.5\text{ V to }3.5\text{ V}, R_L = 10\text{ k}\Omega^\ddagger, C_L = 100\text{ pF}^\ddagger$ | 25°C | 0.01 | 0.025 | | 0.01 | 0.025 | | V/ μs |
| | | Full range | 0.005 | | | 0.005 | | | |
| V_n Equivalent input noise voltage | $f = 10\text{ Hz}$ | 25°C | 72 | | | 72 | | | nV/ $\sqrt{\text{Hz}}$ |
| | $f = 1\text{ kHz}$ | 25°C | 21 | | | 21 | | | |
| $V_{N(PP)}$ Peak-to-peak equivalent input noise voltage | $f = 0.1\text{ Hz to }1\text{ Hz}$ | 25°C | 600 | | | 600 | | | μV |
| | $f = 0.1\text{ Hz to }10\text{ Hz}$ | 25°C | 800 | | | 800 | | | |
| I_n Equivalent input noise current | | 25°C | 0.6 | | | 0.6 | | | fA/ $\sqrt{\text{Hz}}$ |
| Gain-bandwidth product | $f = 10\text{ kHz}, R_L = 10\text{ k}\Omega^\ddagger, C_L = 100\text{ pF}^\ddagger$ | 25°C | 65 | | | 65 | | | kHz |
| BOM Maximum output-swing bandwidth | $V_{O(PP)} = 2\text{ V}, R_L = 10\text{ k}\Omega^\ddagger, A_V = 1, C_L = 100\text{ pF}^\ddagger$ | 25°C | 7 | | | 7 | | | kHz |
| ϕ_m Phase margin at unity gain | $R_L = 10\text{ k}\Omega^\ddagger, C_L = 100\text{ pF}^\ddagger$ | 25°C | 56° | | | 56° | | | |
| | | Gain margin | 25°C | 22 | | | 22 | | |

† Full range is -40°C to 85°C .

‡ Referenced to 1.5 V

electrical characteristics at $V_{DD} = 3\text{ V}, T_A = 25^\circ\text{C}$ (unless otherwise noted)

| PARAMETER | TEST CONDITIONS | TLV2211Y | | | UNIT |
|--|---|------------------------------------|-----|-----|---------------|
| | | MIN | TYP | MAX | |
| V_{IO} Input offset voltage | $V_{DD} \pm \pm 1.5\text{ V}, V_O = 0, V_{IC} = 0, R_S = 50\ \Omega$ | 0.47 | | | mV |
| I_{IO} Input offset current | | 0.5 | | | pA |
| I_{IB} Input bias current | | 1 | | | pA |
| V_{ICR} Common-mode input voltage range | $ V_{IO} \leq 5\text{ mV}, R_S = 50\ \Omega$ | -0.3 to 2.2 | | | V |
| V_{OH} High-level output voltage | $I_{OH} = -100\ \mu\text{A}$ | 2.94 | | | V |
| | $I_{OH} = -200\ \mu\text{A}$ | 2.85 | | | |
| V_{OL} Low-level output voltage | $V_{IC} = 0, I_{OL} = 50\ \mu\text{A}$ | 15 | | | mV |
| | $V_{IC} = 0, I_{OL} = 500\ \mu\text{A}$ | 150 | | | |
| A_{VD} Large-signal differential voltage amplification | $V_{IC} = 1.5\text{ V}, V_O = 1\text{ V to }2\text{ V}$ | $R_L = 10\text{ k}\Omega^\ddagger$ | 7 | | V/mV |
| | | $R_L = 1\text{ M}\Omega^\ddagger$ | 600 | | |
| $r_{i(d)}$ Differential input resistance | | 10^{12} | | | Ω |
| $r_{i(c)}$ Common-mode input resistance | | 10^{12} | | | Ω |
| $c_{i(c)}$ Common-mode input capacitance | $f = 10\text{ kHz}$ | 5 | | | pF |
| z_o Closed-loop output impedance | $f = 7\text{ kHz}, A_V = 1$ | 200 | | | Ω |
| CMRR Common-mode rejection ratio | $V_{IC} = 0\text{ to }1.7\text{ V}, V_O = 1.5\text{ V}, R_S = 50\ \Omega$ | 83 | | | dB |
| k_{SVR} Supply voltage rejection ratio ($\Delta V_{DD}/\Delta V_{IO}$) | $V_{DD} = 2.7\text{ V to }8\text{ V}, V_{IC} = V_{DD}/2, \text{ No load}$ | 95 | | | dB |
| I_{DD} Supply current | $V_O = 1.5\text{ V}, \text{ No load}$ | 11 | | | μA |

† Referenced to 1.5 V

TLV2211, TLV2211Y
Advanced LinCMOS™ RAIL-TO-RAIL
MICROPOWER SINGLE OPERATIONAL AMPLIFIERS
 SLOS156B – MAY 1996 – REVISED JANUARY 1997

electrical characteristics at $V_{DD} = 5\text{ V}$, $T_A = 25^\circ\text{C}$ (unless otherwise noted)

| PARAMETER | TEST CONDITIONS | TLV2211Y | | | UNIT |
|---|--|-----------------------------------|-----|-----|---------------|
| | | MIN | TYP | MAX | |
| V_{IO} Input offset voltage | $V_{DD} \pm = \pm 2.5\text{ V}$, $R_S = 50\ \Omega$, $V_{IC} = 0$, $V_O = 0$ | 0.45 | | | mV |
| I_{IO} Input offset current | | 0.5 | | | pA |
| I_{IB} Input bias current | | 1 | | | pA |
| V_{ICR} Common-mode input voltage range | $ V_{IO} \leq 5\text{ mV}$, $R_S = 50\ \Omega$ | -0.3 to 4.2 | | | V |
| V_{OH} High-level output voltage | $I_{OH} = -100\ \mu\text{A}$ | 4.95 | | | V |
| | $I_{OH} = -250\ \mu\text{A}$ | 4.875 | | | |
| V_{OL} Low-level output voltage | $V_{IC} = 2.5\text{ V}$, $I_{OL} = 50\ \mu\text{A}$ | 12 | | | mV |
| | $V_{IC} = 2.5\text{ V}$, $I_{OL} = 500\ \mu\text{A}$ | 120 | | | |
| AVD Large-signal differential voltage amplification | $V_{IC} = 2.5\text{ V}$, $V_O = 1\text{ V to }4\text{ V}$ | $R_L = 10\text{ k}\Omega^\dagger$ | 12 | | V/mV |
| | | $R_L = 1\text{ M}\Omega^\dagger$ | 800 | | |
| $r_{i(d)}$ Differential input resistance | | 10 ¹² | | | Ω |
| $r_{i(c)}$ Common-mode input resistance | | 10 ¹² | | | Ω |
| $C_{i(c)}$ Common-mode input capacitance | $f = 10\text{ kHz}$ | 5 | | | pF |
| Z_o Closed-loop output impedance | $f = 7\text{ kHz}$, $A_V = 1$ | 200 | | | Ω |
| CMRR Common-mode rejection ratio | $V_{IC} = 0\text{ to }2.7\text{ V}$, $V_O = 2.5\text{ V}$, $R_S = 50\ \Omega$ | 83 | | | dB |
| kSVR Supply voltage rejection ratio ($\Delta V_{DD}/\Delta V_{IO}$) | $V_{DD} = 4.4\text{ V to }8\text{ V}$, $V_{IC} = V_{DD}/2$, No load | 95 | | | dB |
| I_{DD} Supply current | $V_O = 2.5\text{ V}$, No load | 13 | | | μA |

[†] Referenced to 1.5 V

TYPICAL CHARACTERISTICS

Table of Graphs

| | | FIGURE |
|-----------------|--|---|
| V_{IO} | Input offset voltage | Distribution vs Common-mode input voltage |
| | | 1, 2 3, 4 |
| α_{VIO} | Input offset voltage temperature coefficient | Distribution |
| | | 5, 6 |
| I_{IB}/I_{IO} | Input bias and input offset currents | vs Free-air temperature |
| | | 7 |
| V_I | Input voltage | vs Supply voltage vs Free-air temperature |
| | | 8 9 |
| V_{OH} | High-level output voltage | vs High-level output current |
| | | 10, 13 |
| V_{OL} | Low-level output voltage | vs Low-level output current |
| | | 11, 12, 14 |
| $V_{O(PP)}$ | Maximum peak-to-peak output voltage | vs Frequency |
| | | 15 |
| I_{OS} | Short-circuit output current | vs Supply voltage vs Free-air temperature |
| | | 16 17 |
| V_O | Output voltage | vs Differential input voltage |
| | | 18, 19 |
| A_{VD} | Differential voltage amplification | vs Load resistance vs Frequency vs Free-air temperature |
| | | 20 21, 22 23, 24 |
| z_o | Output impedance | vs Frequency |
| | | 25, 26 |
| CMRR | Common-mode rejection ratio | vs Frequency vs Free-air temperature |
| | | 27 28 |
| k_{SVR} | Supply-voltage rejection ratio | vs Frequency vs Free-air temperature |
| | | 29, 30 31 |
| I_{DD} | Supply current | vs Supply voltage |
| | | 32 |
| SR | Slew rate | vs Load capacitance vs Free-air temperature |
| | | 33 34 |
| V_O | Large-signal pulse response | vs Time |
| | | 35, 36, 37, 38 |
| V_O | Small-signal pulse response | vs Time |
| | | 39, 40, 41, 42 |
| V_n | Equivalent input noise voltage | vs Frequency |
| | | 43, 44 |
| | Noise voltage (referred to input) | Over a 10-second period |
| | | 45 |
| THD + N | Total harmonic distortion plus noise | vs Frequency |
| | | 46 |
| | Gain-bandwidth product | vs Free-air temperature vs Supply voltage |
| | | 47 48 |
| ϕ_m | Phase margin | vs Frequency vs Load capacitance |
| | | 21, 22 49 |
| | Gain margin | vs Load capacitance |
| | | 50 |
| B_1 | Unity-gain bandwidth | vs Load capacitance |
| | | 51 |

TYPICAL CHARACTERISTICS

DISTRIBUTION OF TLV2211
 INPUT OFFSET VOLTAGE

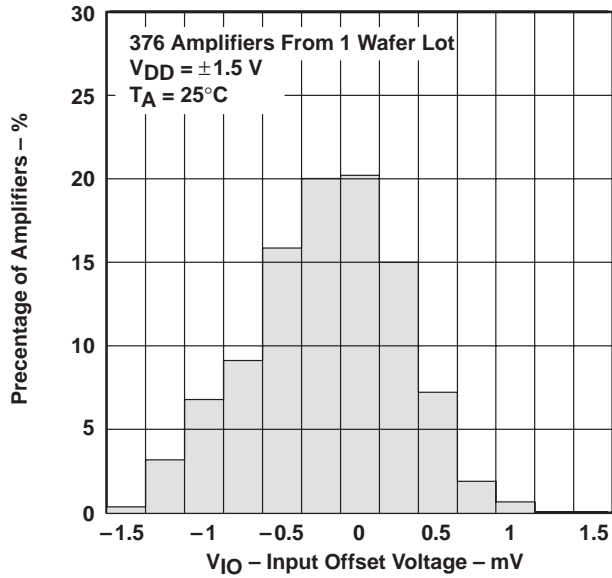

Figure 1

DISTRIBUTION OF TLV2211
 INPUT OFFSET VOLTAGE

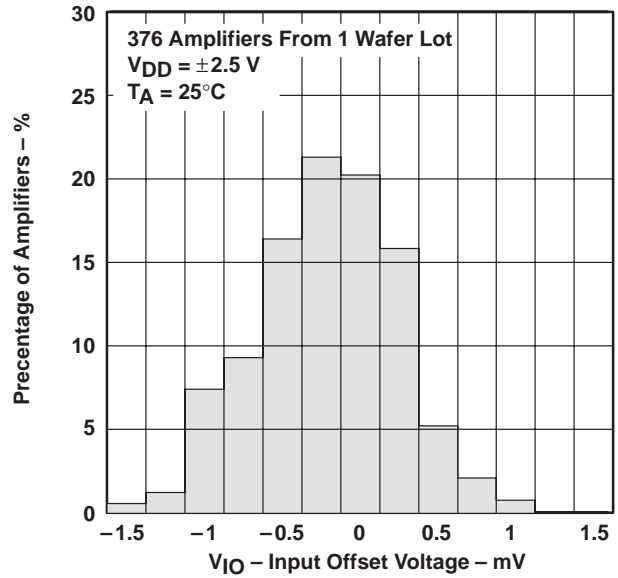

Figure 2

INPUT OFFSET VOLTAGE†
 vs
 COMMON-MODE INPUT VOLTAGE

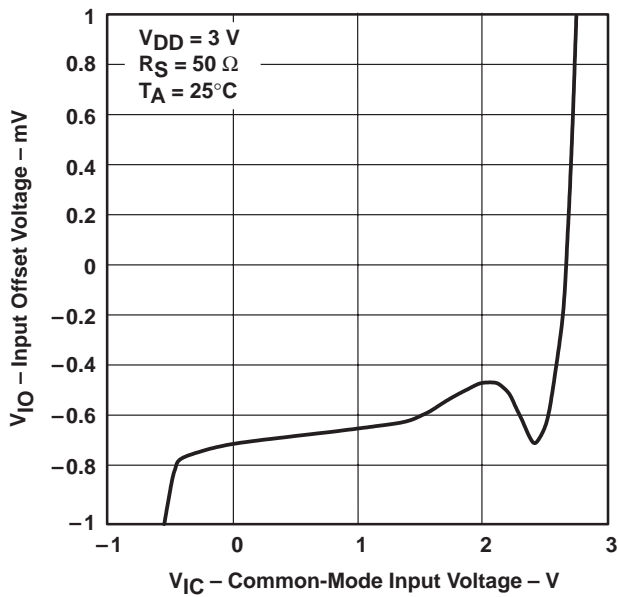

Figure 3

INPUT OFFSET VOLTAGE†
 vs
 COMMON-MODE INPUT VOLTAGE

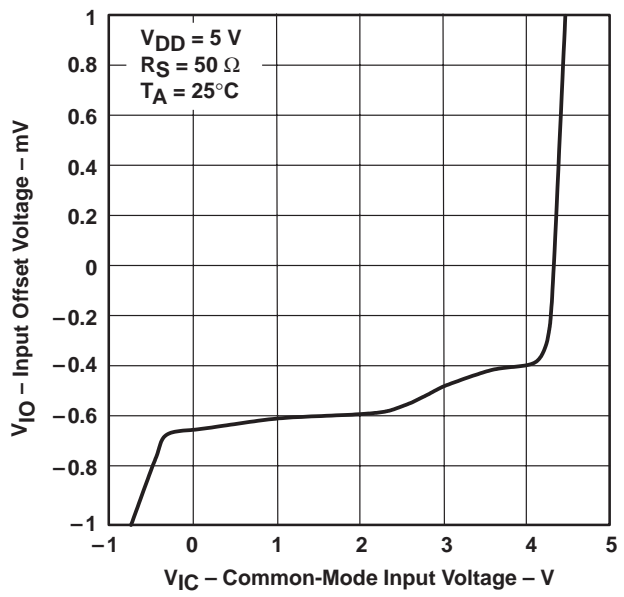

Figure 4

† For all curves where $V_{DD} = 5\text{ V}$, all loads are referenced to 2.5 V. For all curves where $V_{DD} = 3\text{ V}$, all loads are referenced to 1.5 V.

TYPICAL CHARACTERISTICS

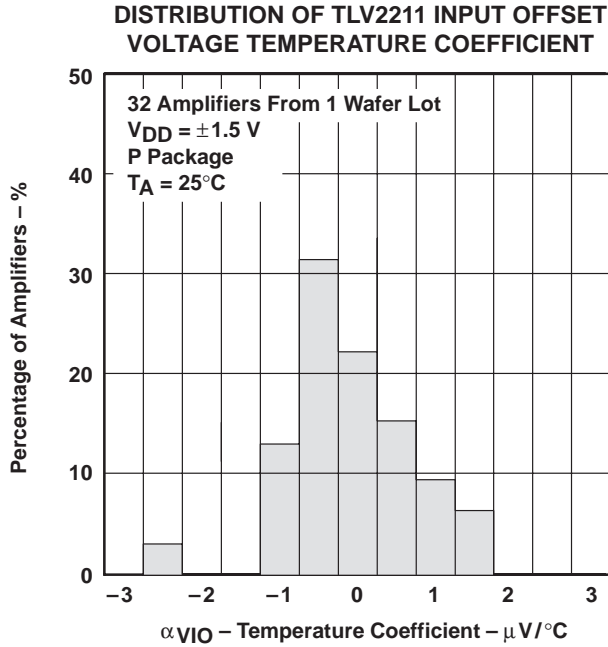

Figure 5

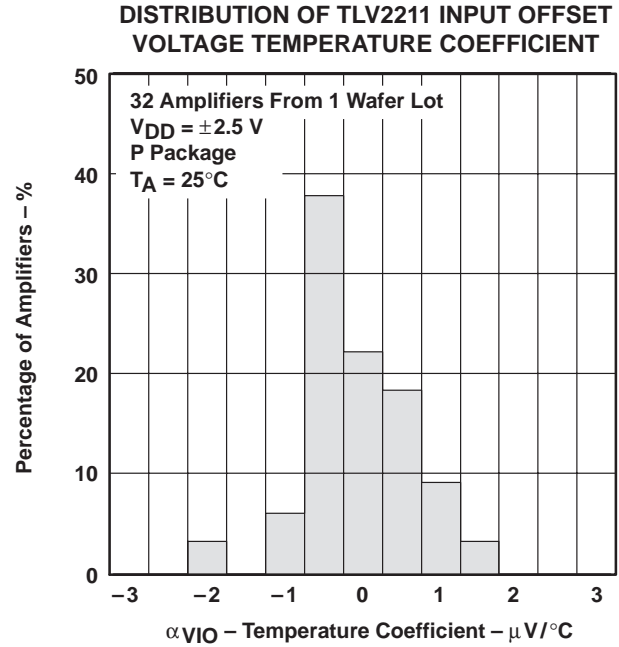

Figure 6

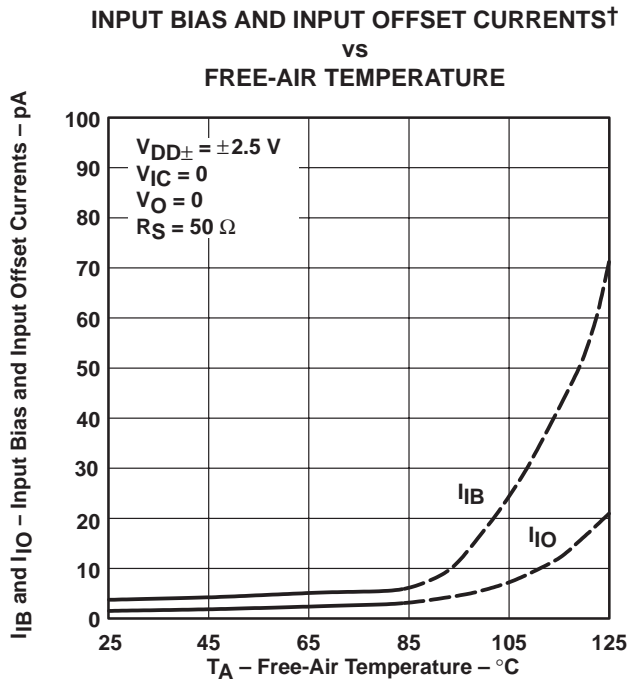

Figure 7

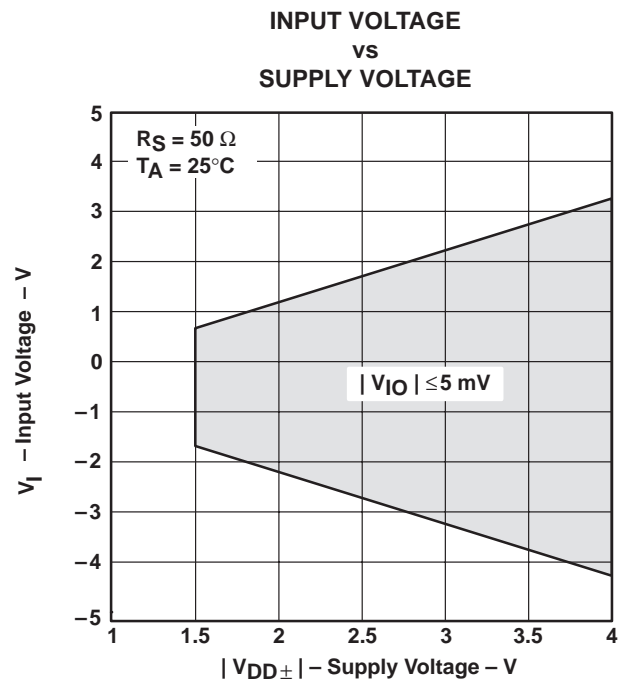

Figure 8

† Data at high and low temperatures are applicable only within the rated operating free-air temperature ranges of the various devices.

TYPICAL CHARACTERISTICS

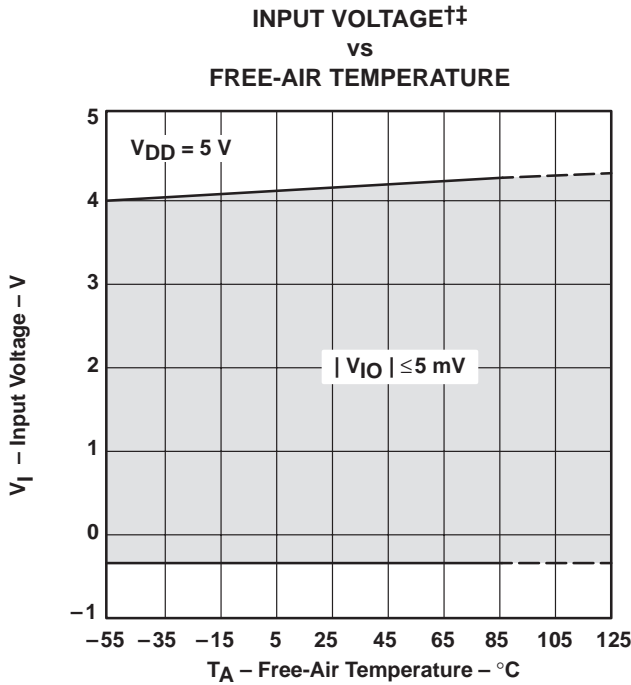

Figure 9

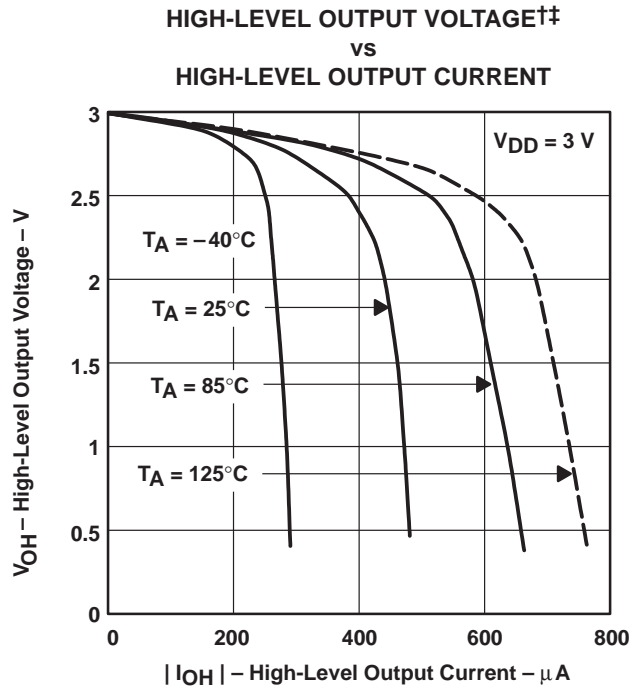

Figure 10

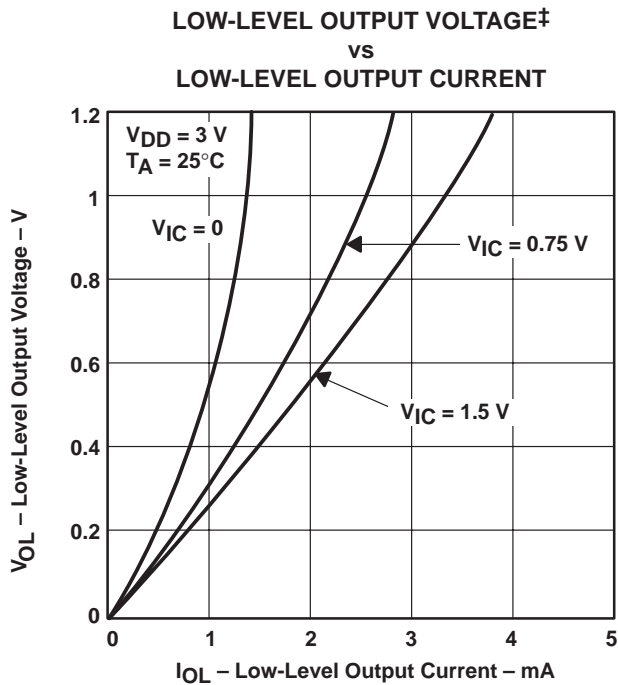

Figure 11

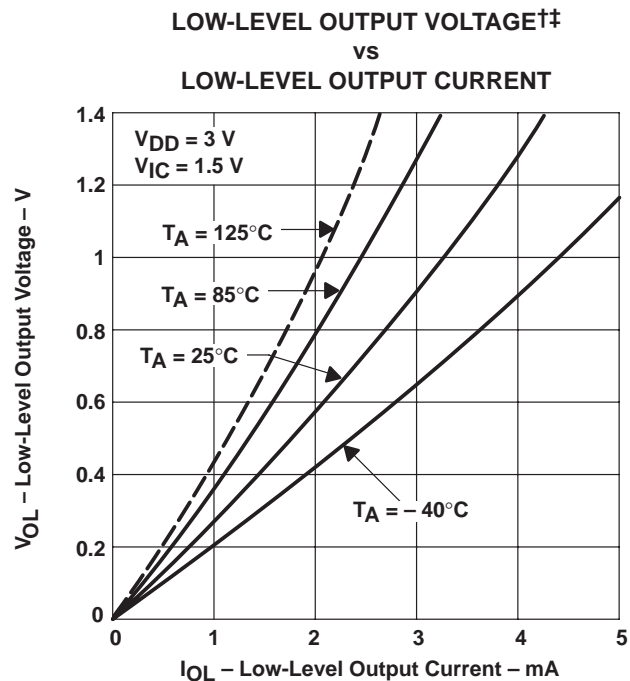
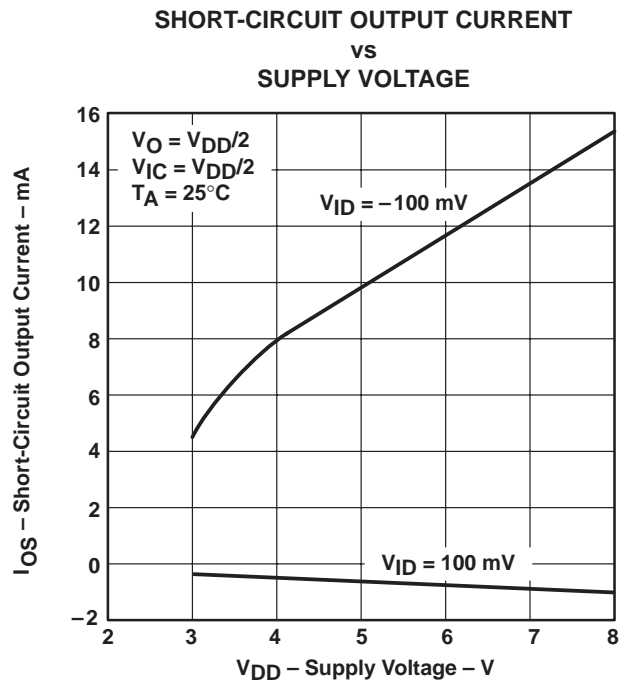
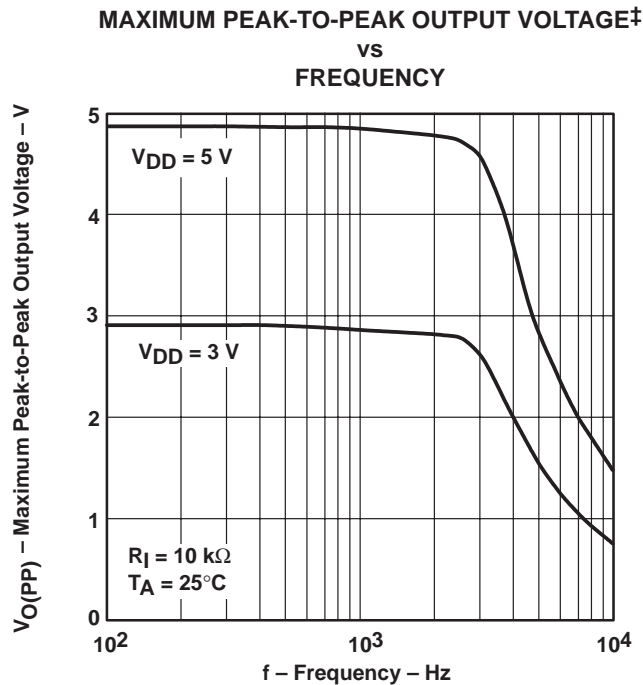
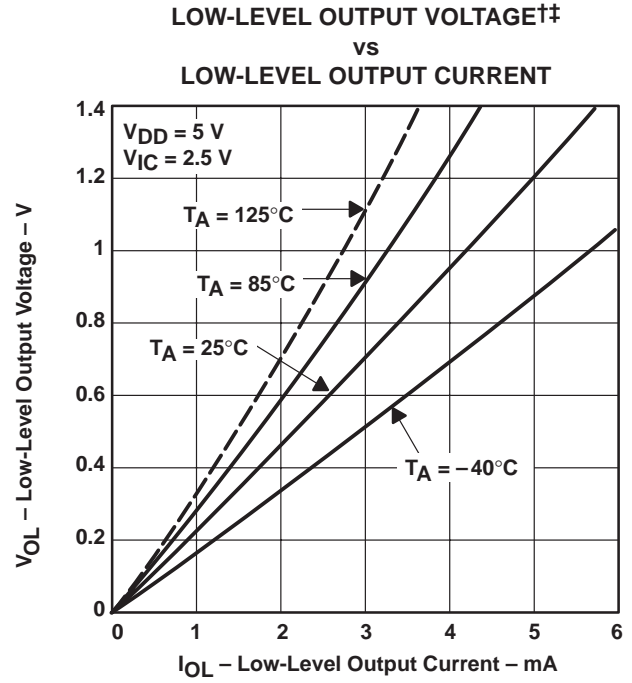
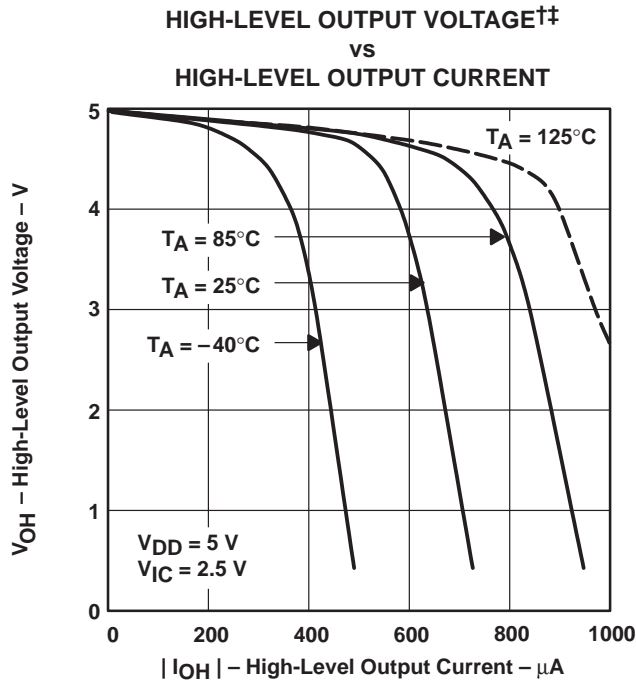

Figure 12

[†] Data at high and low temperatures are applicable only within the rated operating free-air temperature ranges of the various devices.
^{††} For all curves where $V_{DD} = 5 \text{ V}$, all loads are referenced to 2.5 V. For all curves where $V_{DD} = 3 \text{ V}$, all loads are referenced to 1.5 V.

TYPICAL CHARACTERISTICS



† Data at high and low temperatures are applicable only within the rated operating free-air temperature ranges of the various devices.
 ‡ For all curves where $V_{DD} = 5\text{ V}$, all loads are referenced to 2.5 V. For all curves where $V_{DD} = 3\text{ V}$, all loads are referenced to 1.5 V.

TYPICAL CHARACTERISTICS

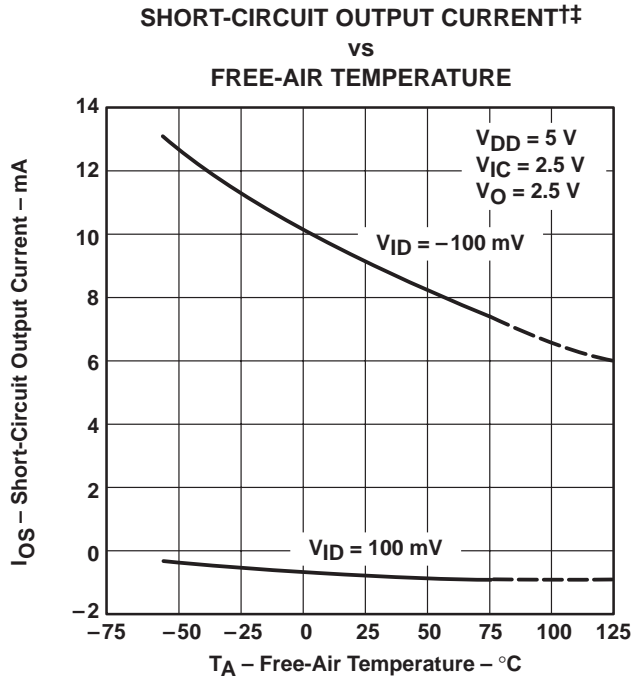

Figure 17

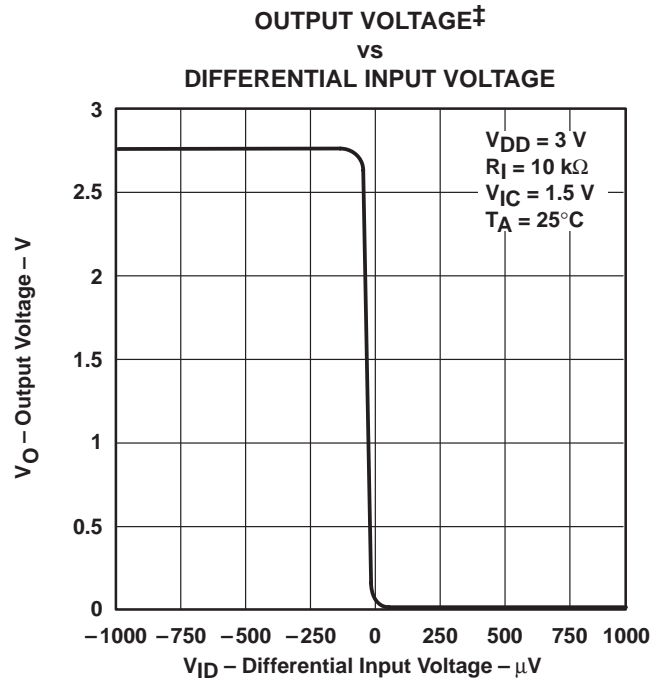

Figure 18

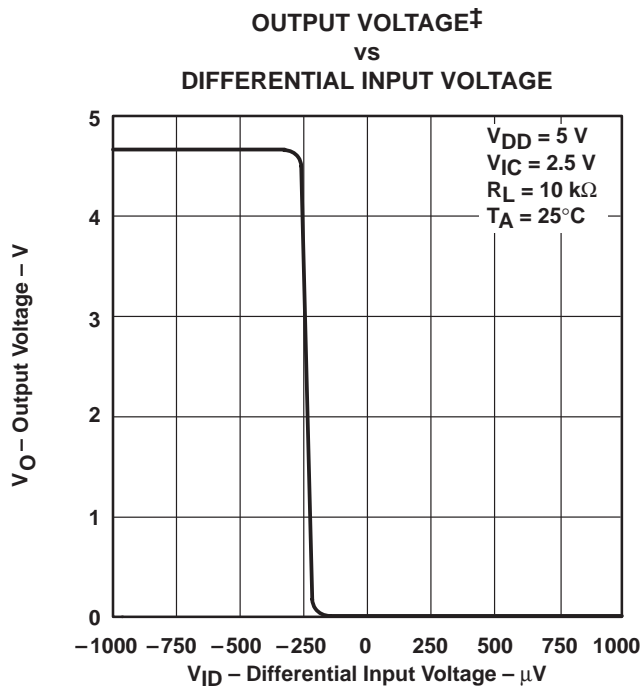

Figure 19

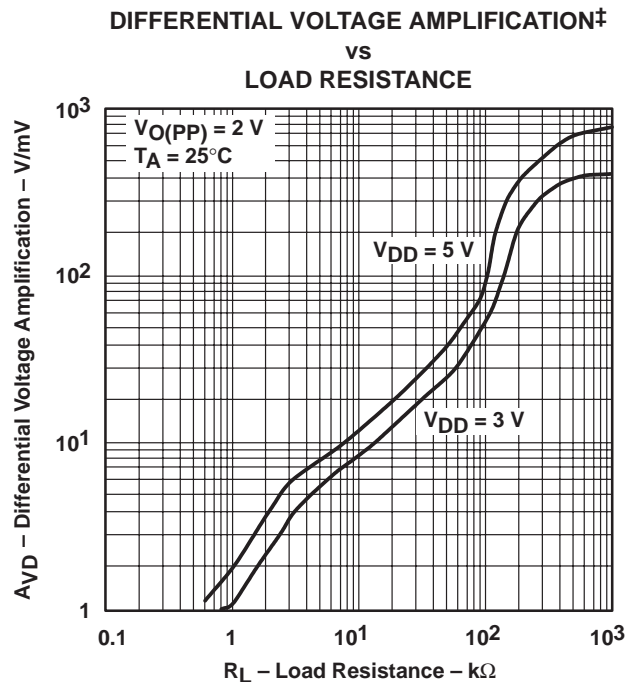

Figure 20

† Data at high and low temperatures are applicable only within the rated operating free-air temperature ranges of the various devices.
 ‡ For all curves where $V_{DD} = 5\text{ V}$, all loads are referenced to 2.5 V. For all curves where $V_{DD} = 3\text{ V}$, all loads are referenced to 1.5 V.

TYPICAL CHARACTERISTICS

**LARGE-SIGNAL DIFFERENTIAL VOLTAGE
 AMPLIFICATION AND PHASE MARGIN†**

vs

FREQUENCY

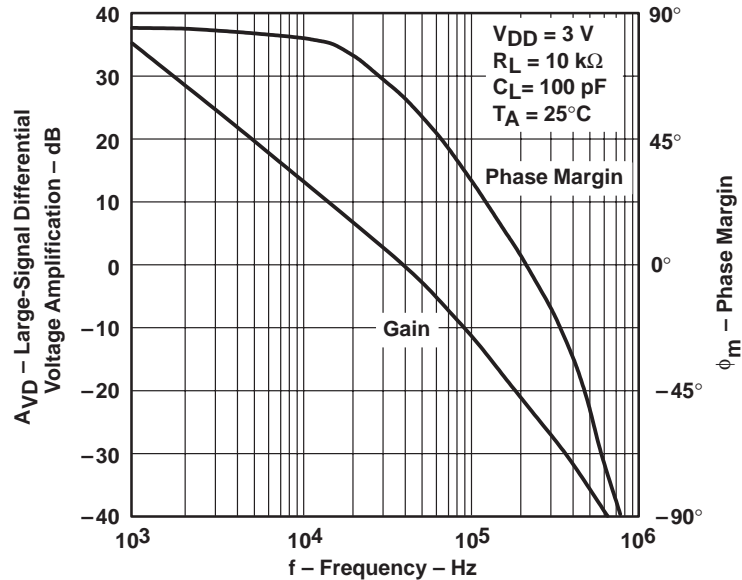

Figure 21

**LARGE-SIGNAL DIFFERENTIAL VOLTAGE
 AMPLIFICATION AND PHASE MARGIN†**

vs

FREQUENCY

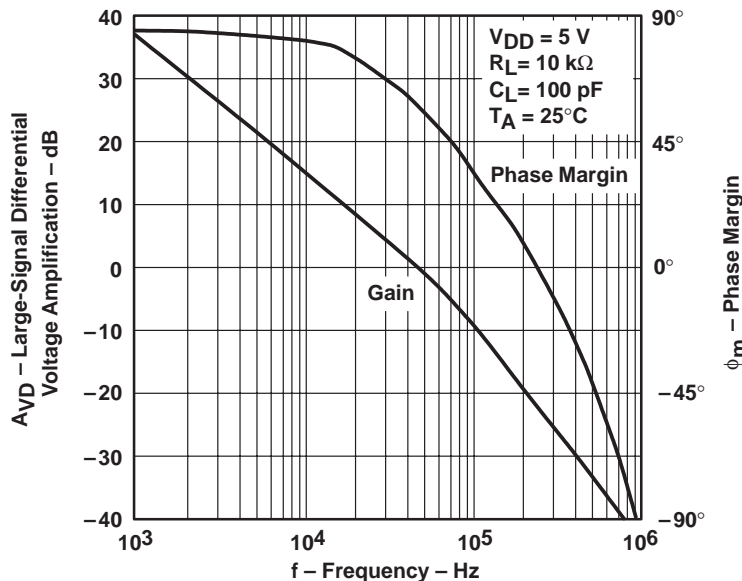
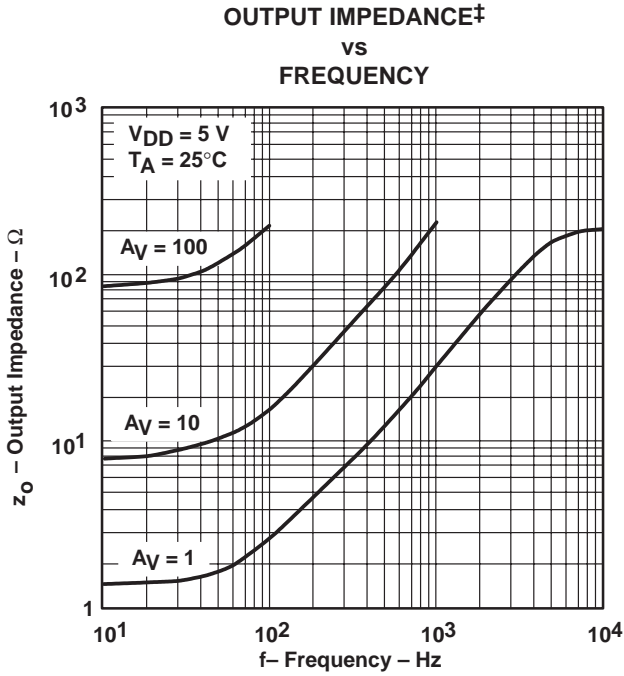
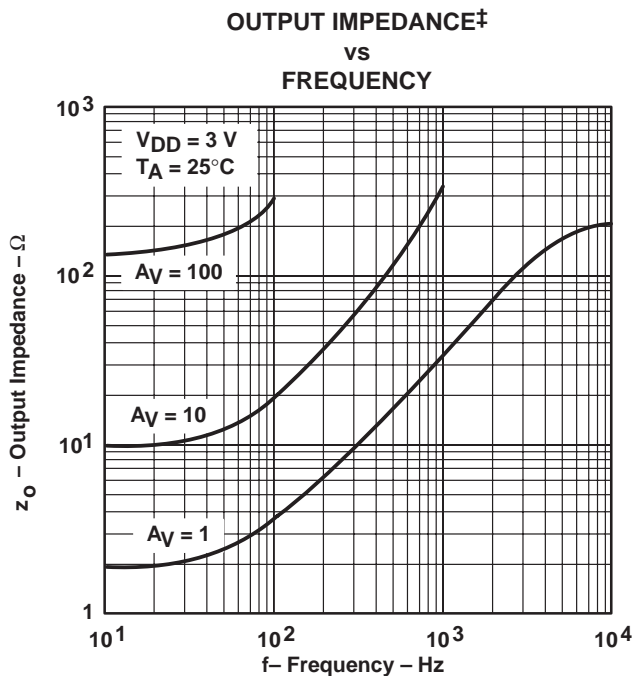
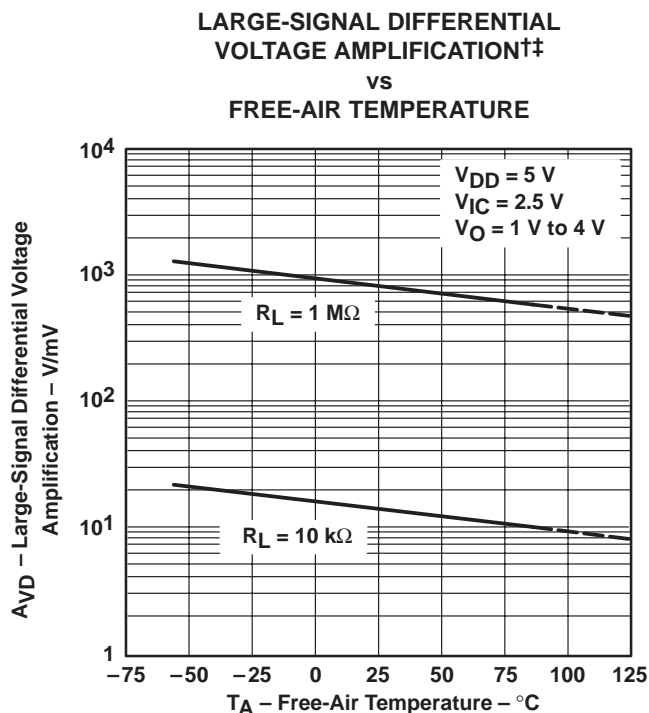
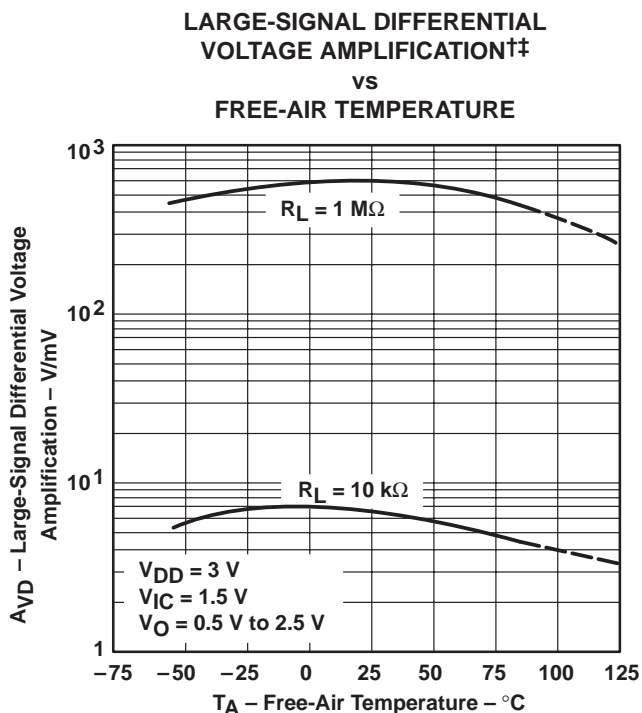

Figure 22

† For all curves where $V_{DD} = 5\text{ V}$, all loads are referenced to 2.5 V. For all curves where $V_{DD} = 3\text{ V}$, all loads are referenced to 1.5 V.

TYPICAL CHARACTERISTICS



† Data at high and low temperatures are applicable only within the rated operating free-air temperature ranges of the various devices.
 ‡ For all curves where $V_{DD} = 5\text{ V}$, all loads are referenced to 2.5 V. For all curves where $V_{DD} = 3\text{ V}$, all loads are referenced to 1.5 V.

TYPICAL CHARACTERISTICS

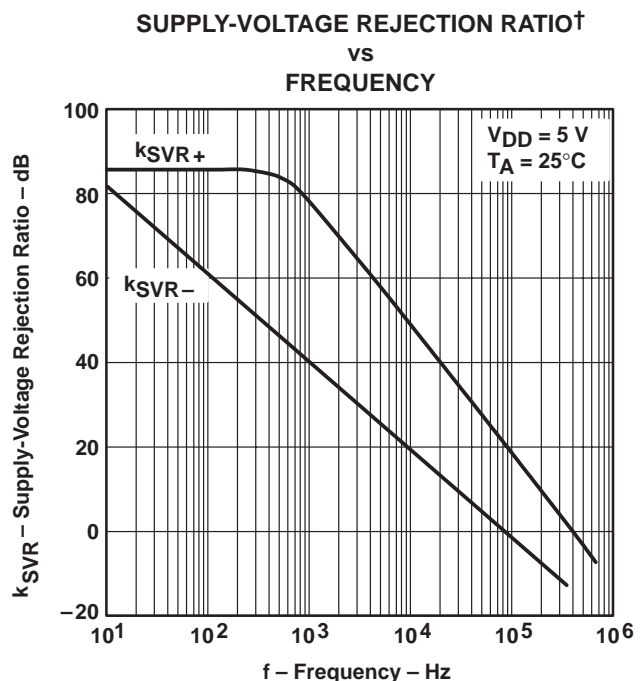
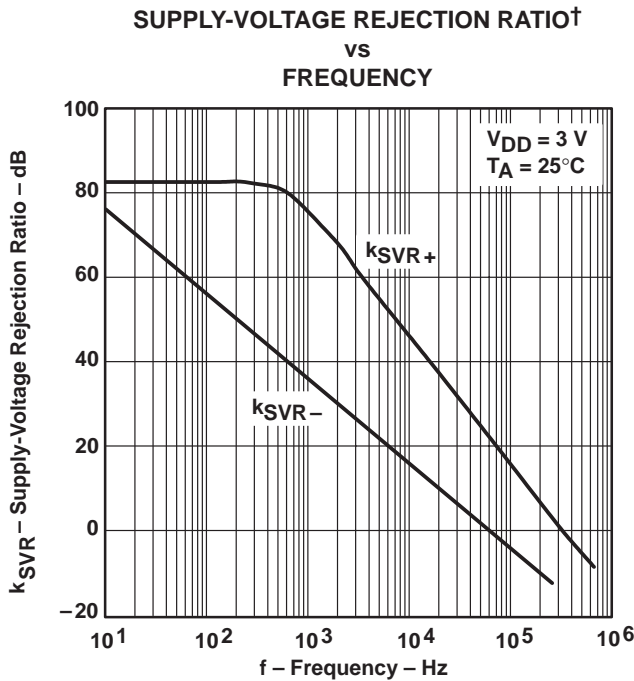
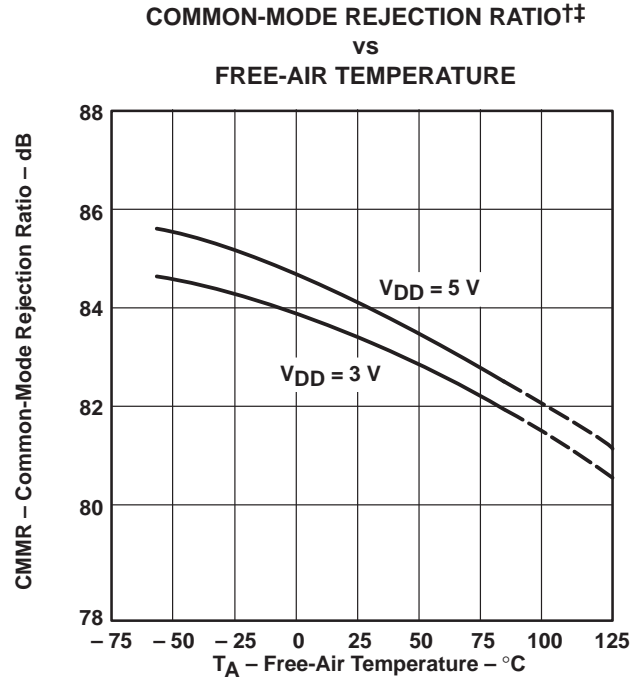
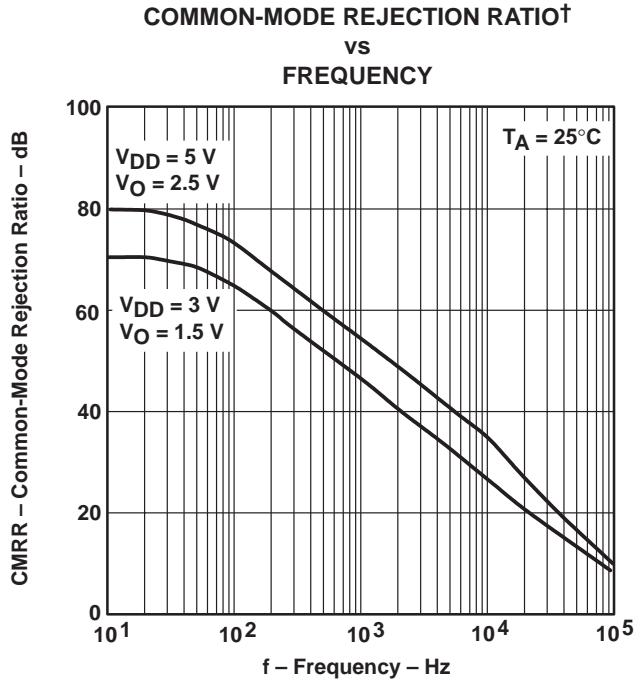

† For all curves where $V_{DD} = 5\text{ V}$, all loads are referenced to 2.5 V. For all curves where $V_{DD} = 3\text{ V}$, all loads are referenced to 1.5 V.
 †† Data at high and low temperatures are applicable only within the rated operating free-air temperature ranges of the various devices.

TYPICAL CHARACTERISTICS

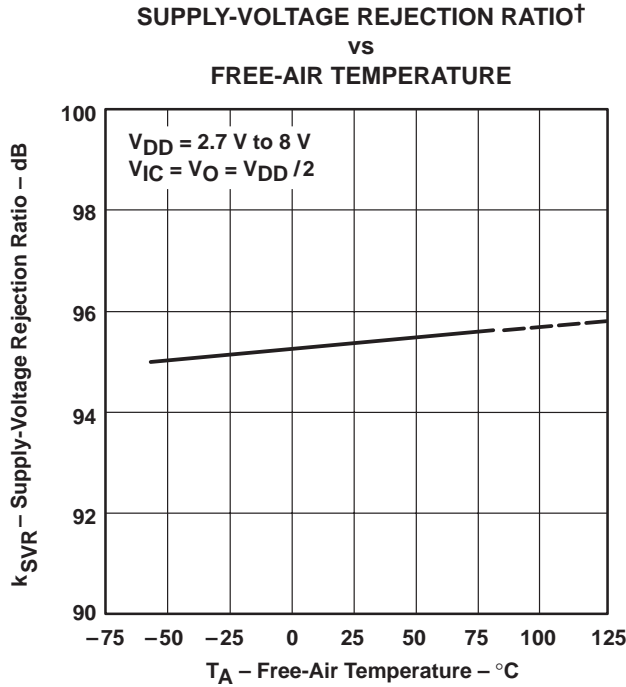

Figure 31

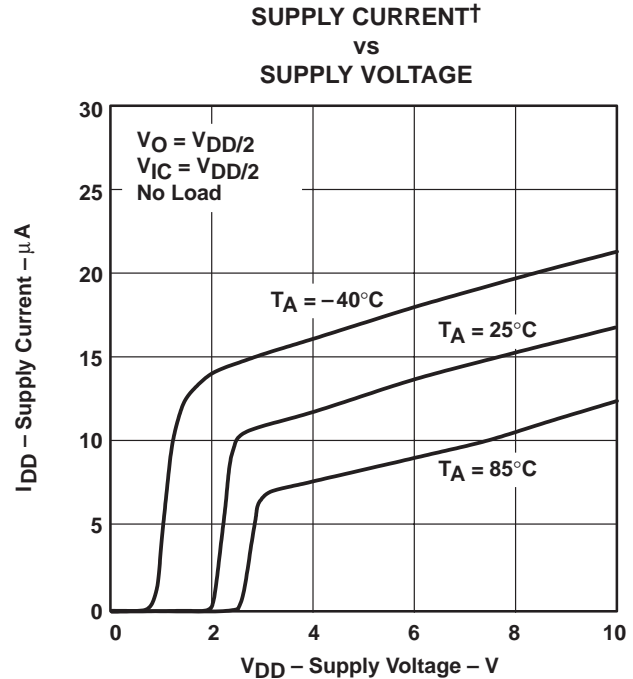

Figure 32

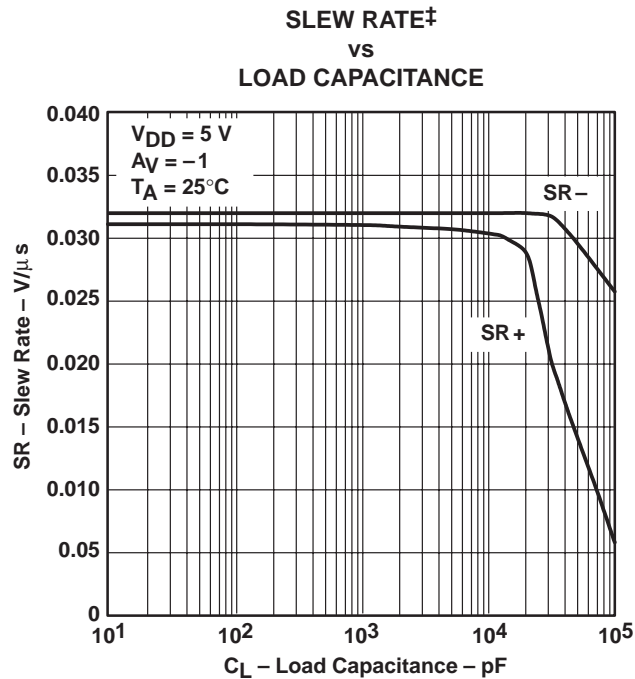

Figure 33

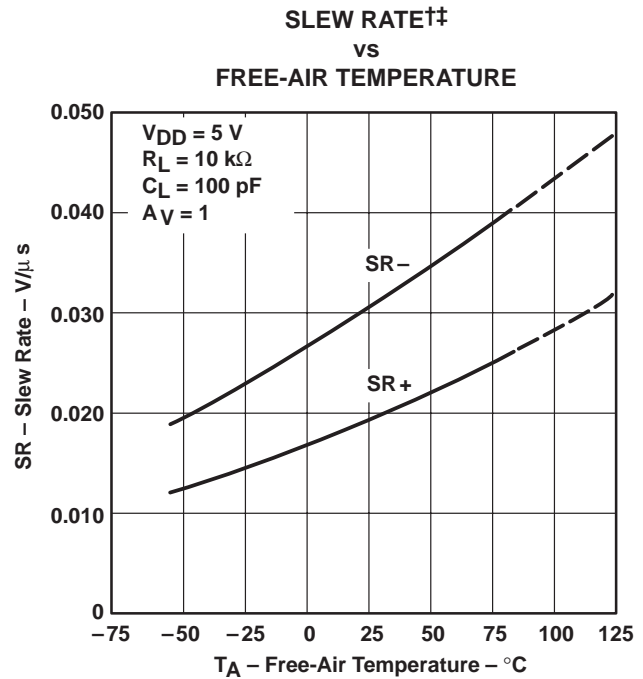

Figure 34

† Data at high and low temperatures are applicable only within the rated operating free-air temperature ranges of the various devices.

‡ For all curves where $V_{DD} = 5 \text{ V}$, all loads are referenced to 2.5 V. For all curves where $V_{DD} = 3 \text{ V}$, all loads are referenced to 1.5 V.

TYPICAL CHARACTERISTICS

INVERTING LARGE-SIGNAL PULSE RESPONSE†

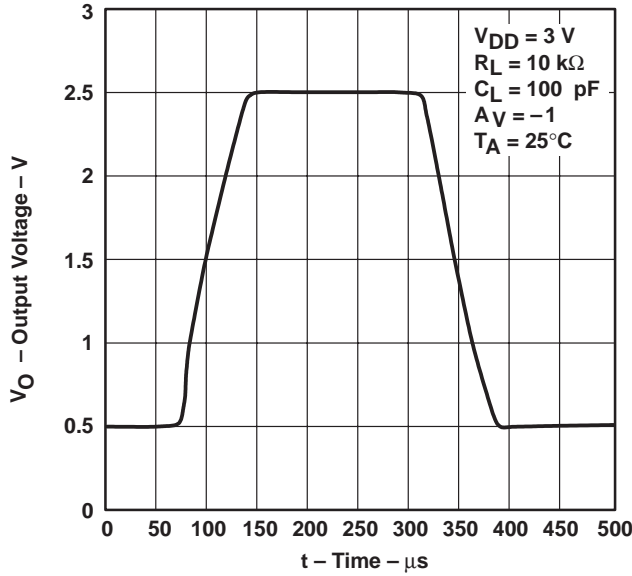

Figure 35

INVERTING LARGE-SIGNAL PULSE RESPONSE†

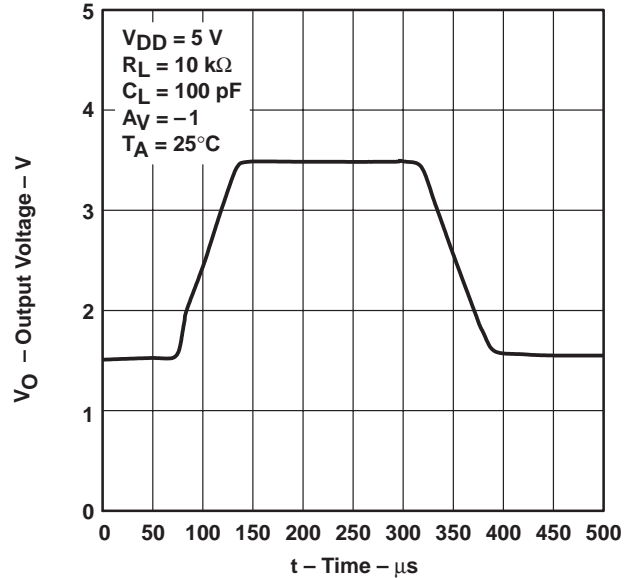

Figure 36

VOLTAGE-FOLLOWER LARGE-SIGNAL PULSE RESPONSE†

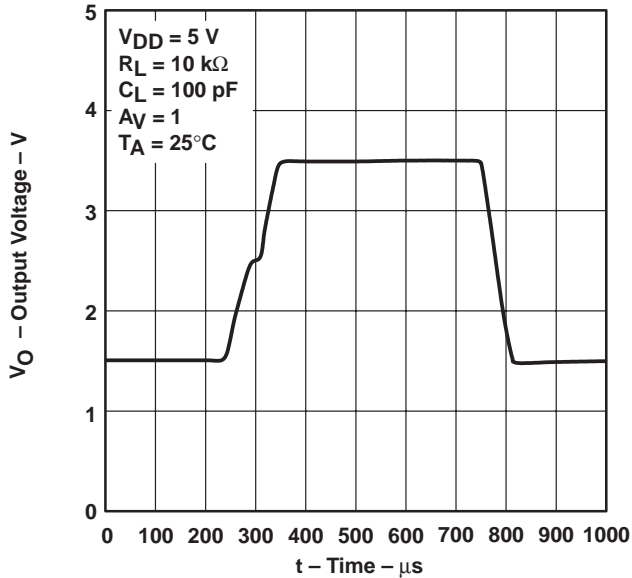

Figure 37

VOLTAGE-FOLLOWER LARGE-SIGNAL PULSE RESPONSE†

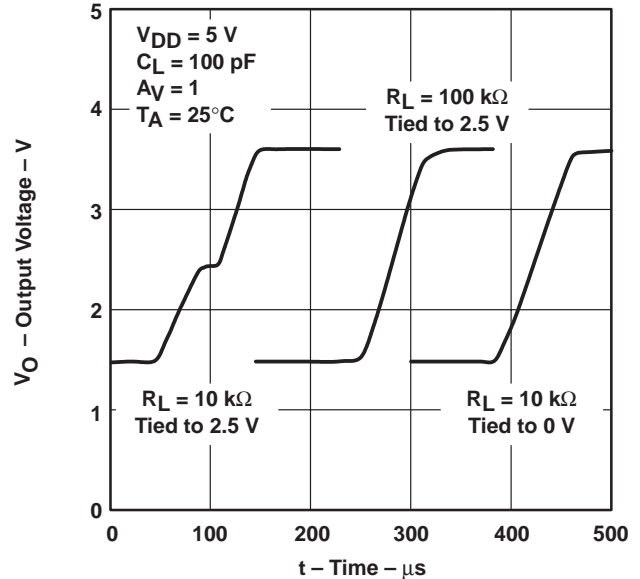

Figure 38

† For all curves where $V_{DD} = 5\text{ V}$, all loads are referenced to 2.5 V. For all curves where $V_{DD} = 3\text{ V}$, all loads are referenced to 1.5 V.

TYPICAL CHARACTERISTICS

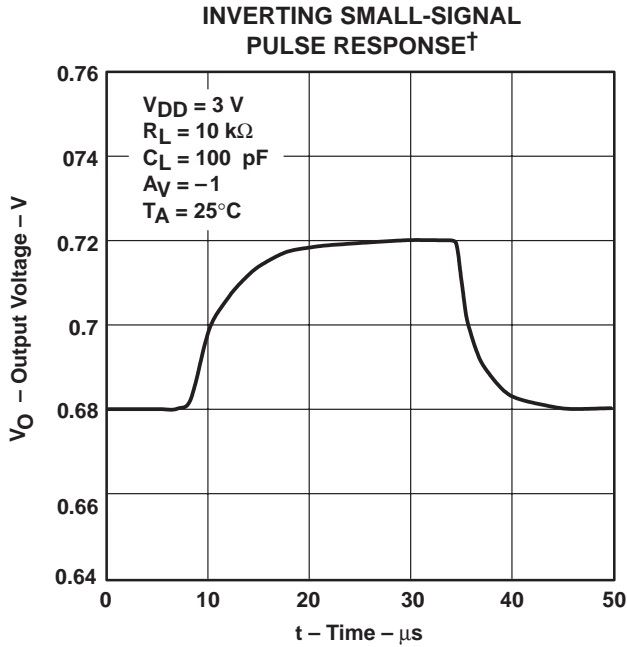

Figure 39

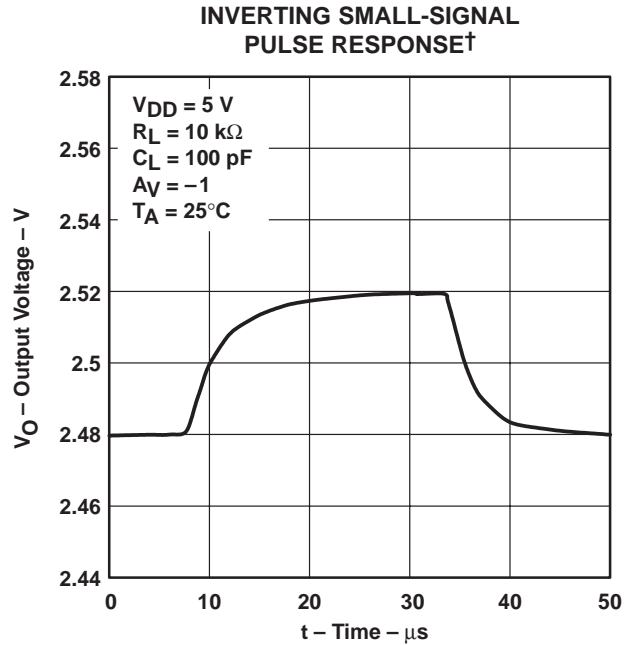

Figure 40

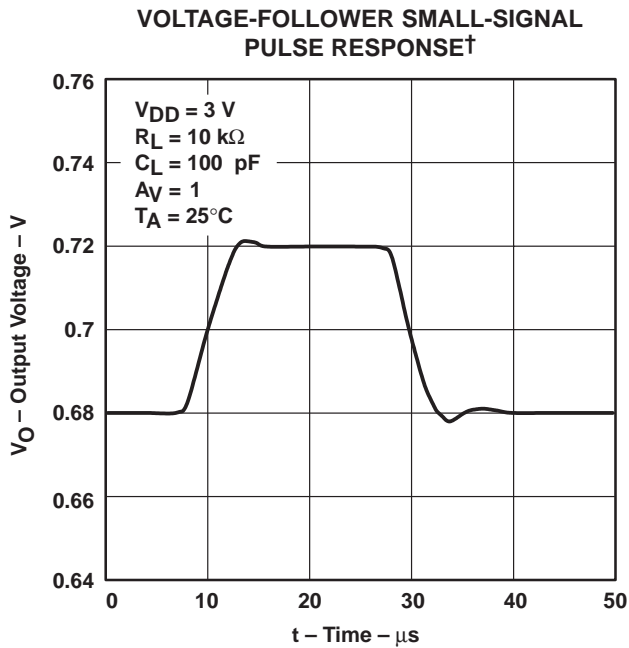

Figure 41

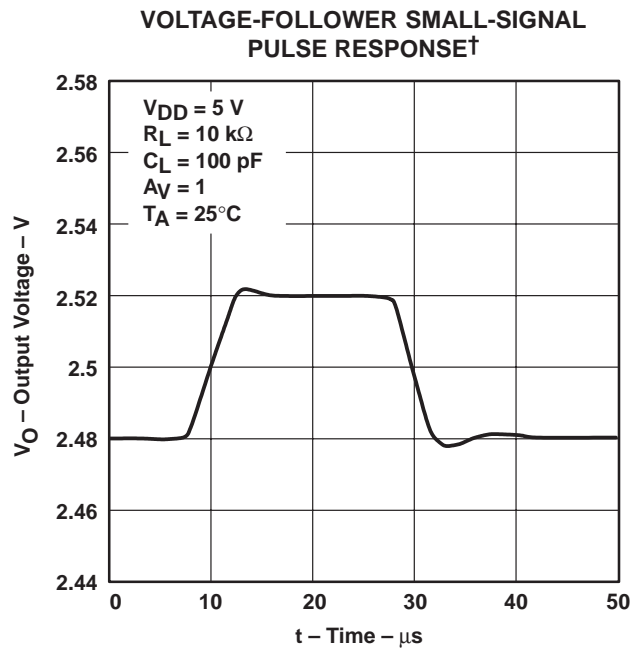
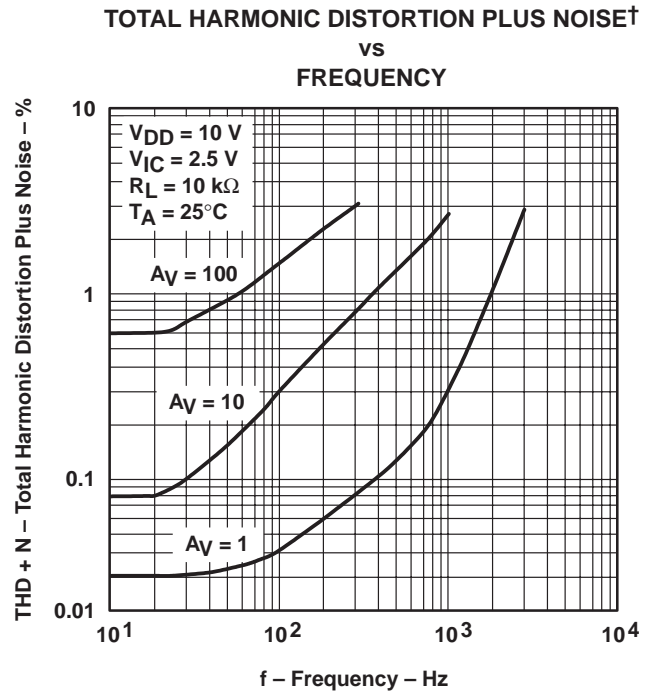
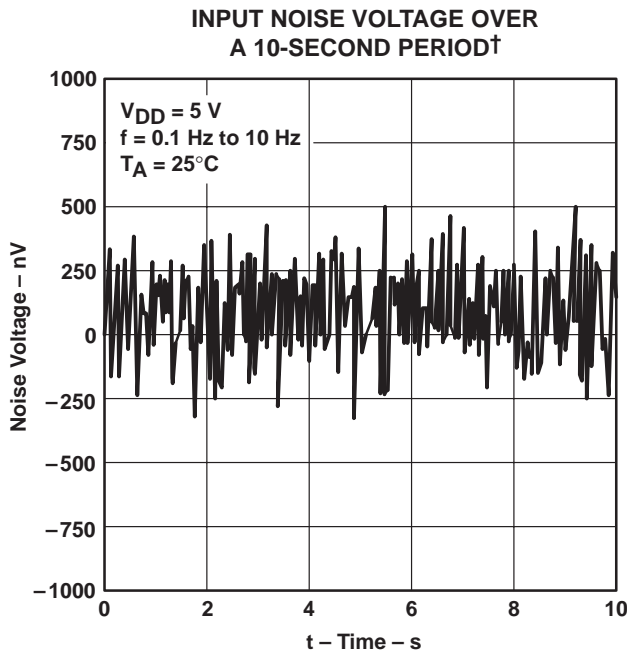
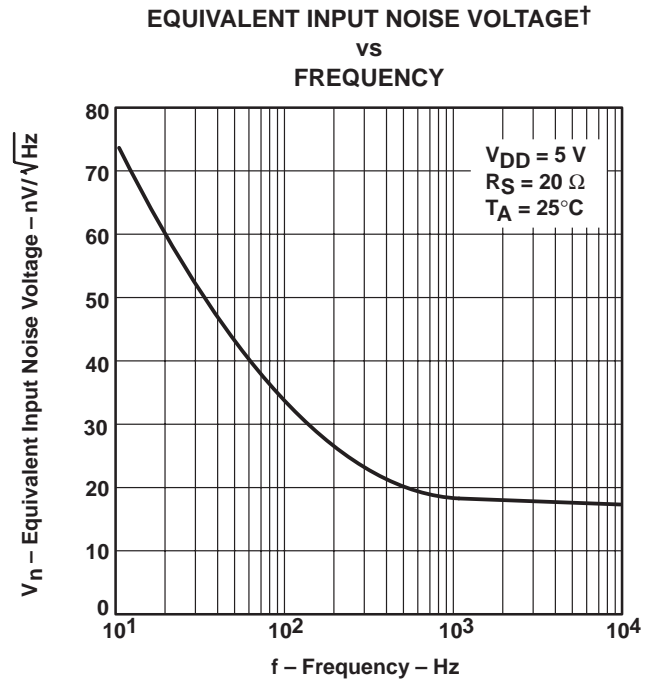
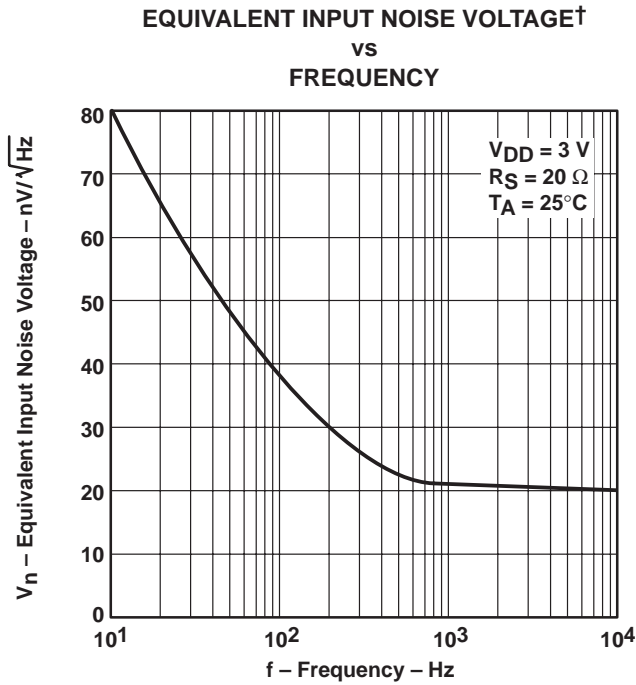

Figure 42

† For all curves where $V_{DD} = 5\text{ V}$, all loads are referenced to 2.5 V. For all curves where $V_{DD} = 3\text{ V}$, all loads are referenced to 1.5 V.

TYPICAL CHARACTERISTICS



† For all curves where $V_{DD} = 5\text{ V}$, all loads are referenced to 2.5 V. For all curves where $V_{DD} = 3\text{ V}$, all loads are referenced to 1.5 V.

TYPICAL CHARACTERISTICS

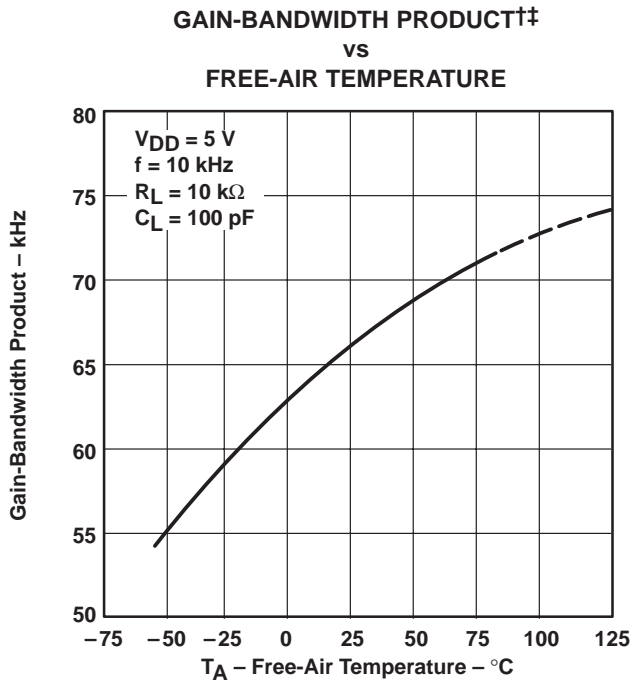

Figure 47

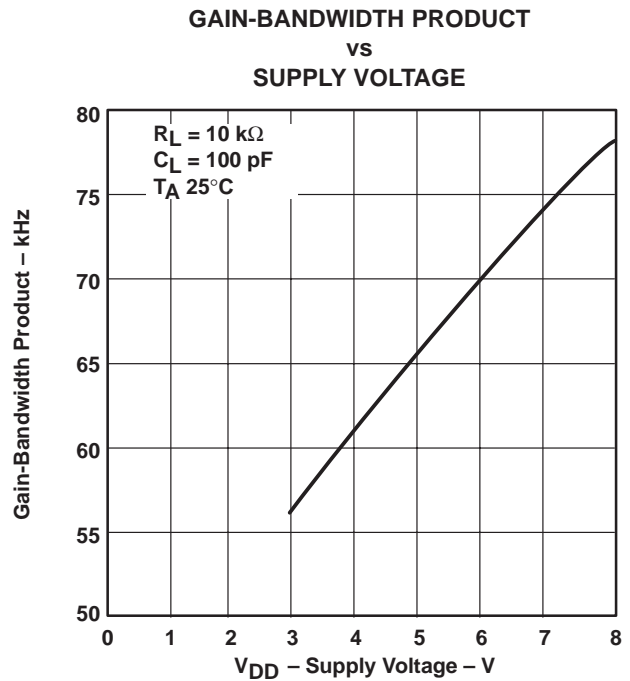

Figure 48

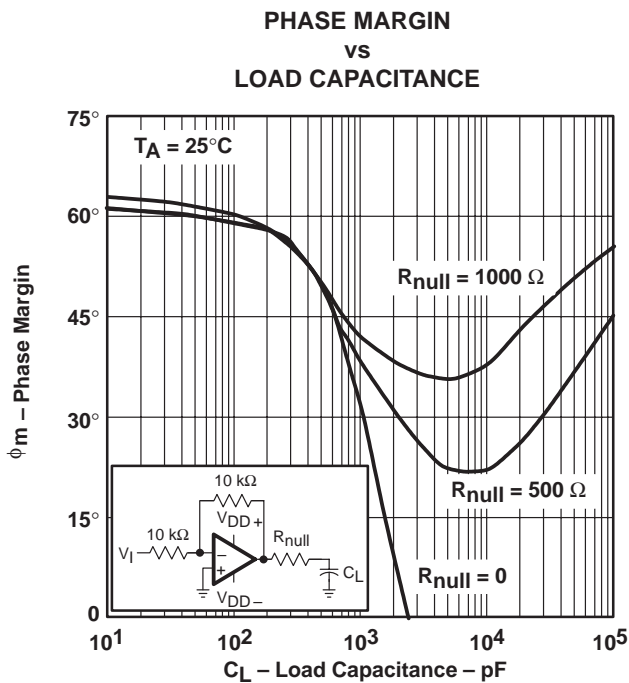

Figure 49

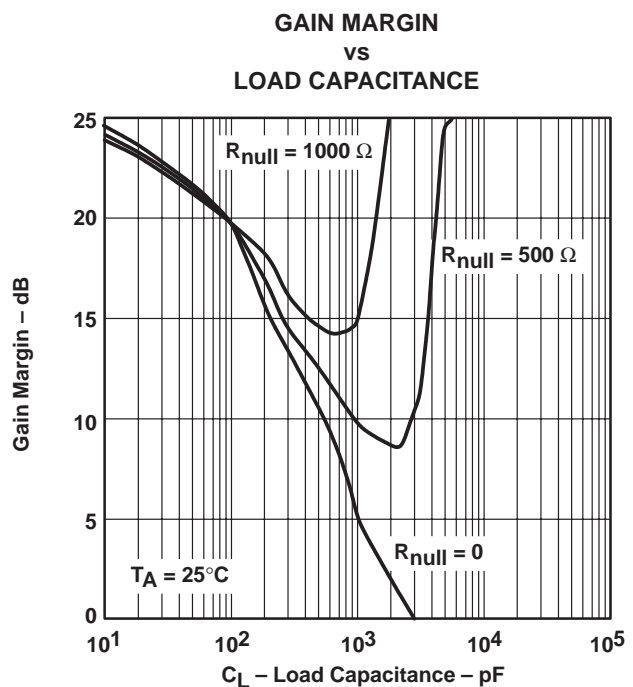

Figure 50

† Data at high and low temperatures are applicable only within the rated operating free-air temperature ranges of the various devices.
 ‡ For all curves where $V_{DD} = 5\text{ V}$, all loads are referenced to 2.5 V. For all curves where $V_{DD} = 3\text{ V}$, all loads are referenced to 1.5 V.

TYPICAL CHARACTERISTICS

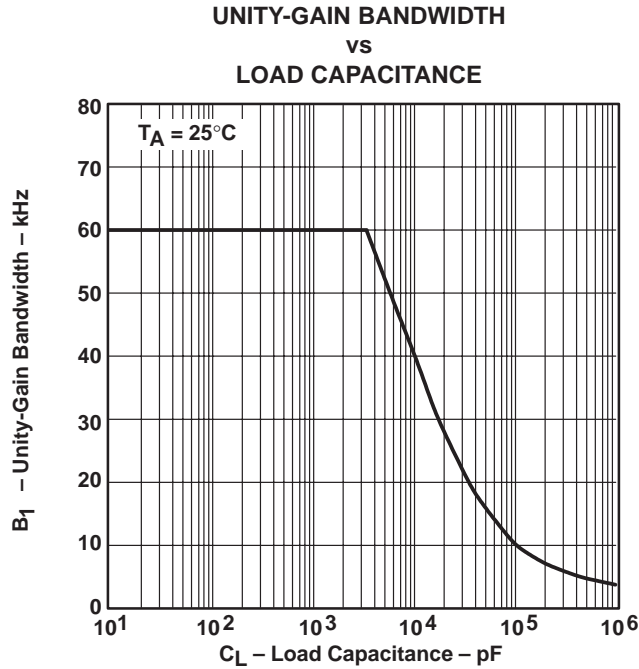

Figure 51

APPLICATION INFORMATION

driving large capacitive loads

The TLV2211 is designed to drive larger capacitive loads than most CMOS operational amplifiers. Figure 49 and Figure 50 illustrate its ability to drive loads up to 600 pF while maintaining good gain and phase margins ($R_{null} = 0$).

A smaller series resistor (R_{null}) at the output of the device (see Figure 52) improves the gain and phase margins when driving large capacitive loads. Figure 49 and Figure 50 show the effects of adding series resistances of 500 Ω and 1000 Ω . The addition of this series resistor has two effects: the first is that it adds a zero to the transfer function and the second is that it reduces the frequency of the pole associated with the output load in the transfer function.

The zero introduced to the transfer function is equal to the series resistance times the load capacitance. To calculate the improvement in phase margin, equation (1) can be used.

$$\Delta\phi_{m1} = \tan^{-1} \left(2 \times \pi \times \text{UGBW} \times R_{null} \times C_L \right) \quad (1)$$

where :

$\Delta\phi_{m1}$ = improvement in phase margin

UGBW = unity-gain bandwidth frequency

R_{null} = output series resistance

C_L = load capacitance

APPLICATION INFORMATION

driving large capacitive loads (continued)

The unity-gain bandwidth (UGBW) frequency decreases as the capacitive load increases (see Figure 51). To use equation (1), UGBW must be approximated from Figure 51.

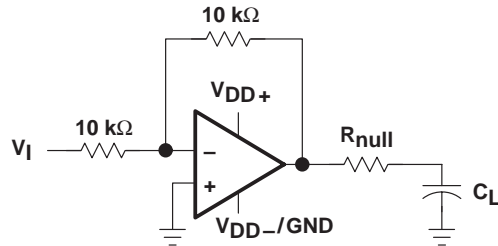

Figure 52. Series-Resistance Circuit

driving heavy dc loads

The TLV2211 is designed to provide better sinking and sourcing output currents than earlier CMOS rail-to-rail output devices. This device is specified to sink $500\ \mu\text{A}$ and source $250\ \mu\text{A}$ at $V_{DD} = 3\text{ V}$ and $V_{DD} = 5\text{ V}$ at a maximum quiescent I_{DD} of $25\ \mu\text{A}$. This provides a greater than 90% power efficiency.

When driving heavy dc loads, such as $10\text{ k}\Omega$, the positive edge under slewing conditions can experience some distortion. This condition can be seen in Figure 37. This condition is affected by three factors.

- Where the load is referenced. When the load is referenced to either rail, this condition does not occur. The distortion occurs only when the output signal swings through the point where the load is referenced. Figure 38 illustrates two $10\text{-k}\Omega$ load conditions. The first load condition shows the distortion seen for a $10\text{-k}\Omega$ load tied to 2.5 V . The third load condition shows no distortion for a $10\text{-k}\Omega$ load tied to 0 V .
- Load resistance. As the load resistance increases, the distortion seen on the output decreases. Figure 38 illustrates the difference seen on the output for a $10\text{-k}\Omega$ load and a $100\text{-k}\Omega$ load with both tied to 2.5 V .
- Input signal edge rate. Faster input edge rates for a step input result in more distortion than with slower input edge rates.

APPLICATION INFORMATION

macromodel information

Macromodel information provided was derived using Microsim *Parts*™, the model generation software used with Microsim *PSpice*™. The Boyle macromodel (see Note 6) and subcircuit in Figure 53 are generated using the TLV2211 typical electrical and operating characteristics at $T_A = 25^\circ\text{C}$. Using this information, output simulations of the following key parameters can be generated to a tolerance of 20% (in most cases):

- Maximum positive output voltage swing
- Maximum negative output voltage swing
- Slew rate
- Quiescent power dissipation
- Input bias current
- Open-loop voltage amplification
- Unity-gain frequency
- Common-mode rejection ratio
- Phase margin
- DC output resistance
- AC output resistance
- Short-circuit output current limit

NOTE 6: G. R. Boyle, B. M. Cohn, D. O. Pederson, and J. E. Solomon, "Macromodeling of Integrated Circuit Operational Amplifiers", *IEEE Journal of Solid-State Circuits*, SC-9, 353 (1974).

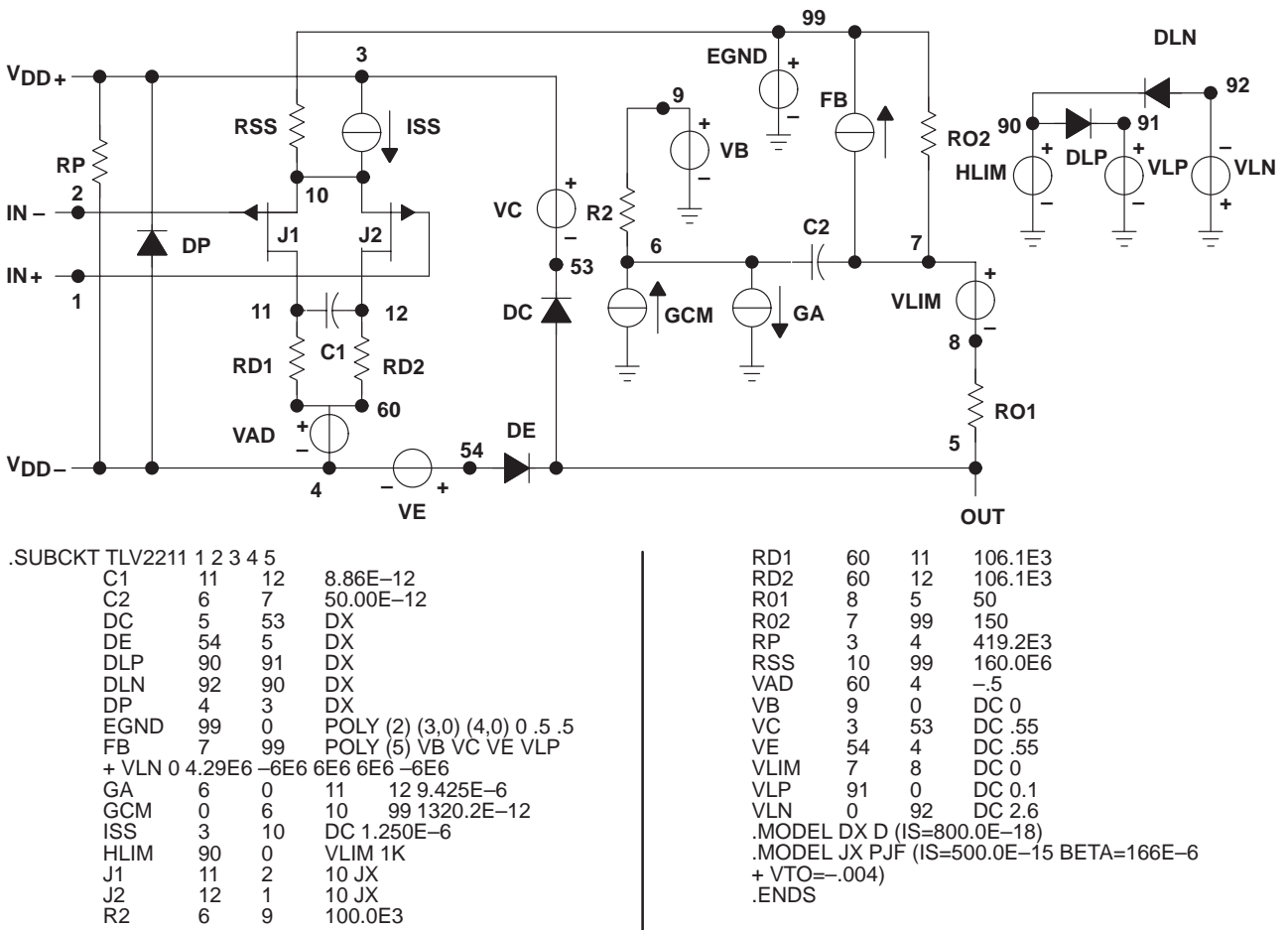

Figure 53. Boyle Macromodel and Subcircuit

PSpice and Parts are trademark of MicroSim Corporation.

TLV2211, TLV2211Y
 Advanced LinCMOS™ RAIL-TO-RAIL
 MICROWPOWER SINGLE OPERATIONAL AMPLIFIERS
 SLOS156B – MAY 1996 – REVISED JANUARY 1997

MECHANICAL INFORMATION

DBV (R-PDSO-G5)

PLASTIC SMALL-OUTLINE PACKAGE

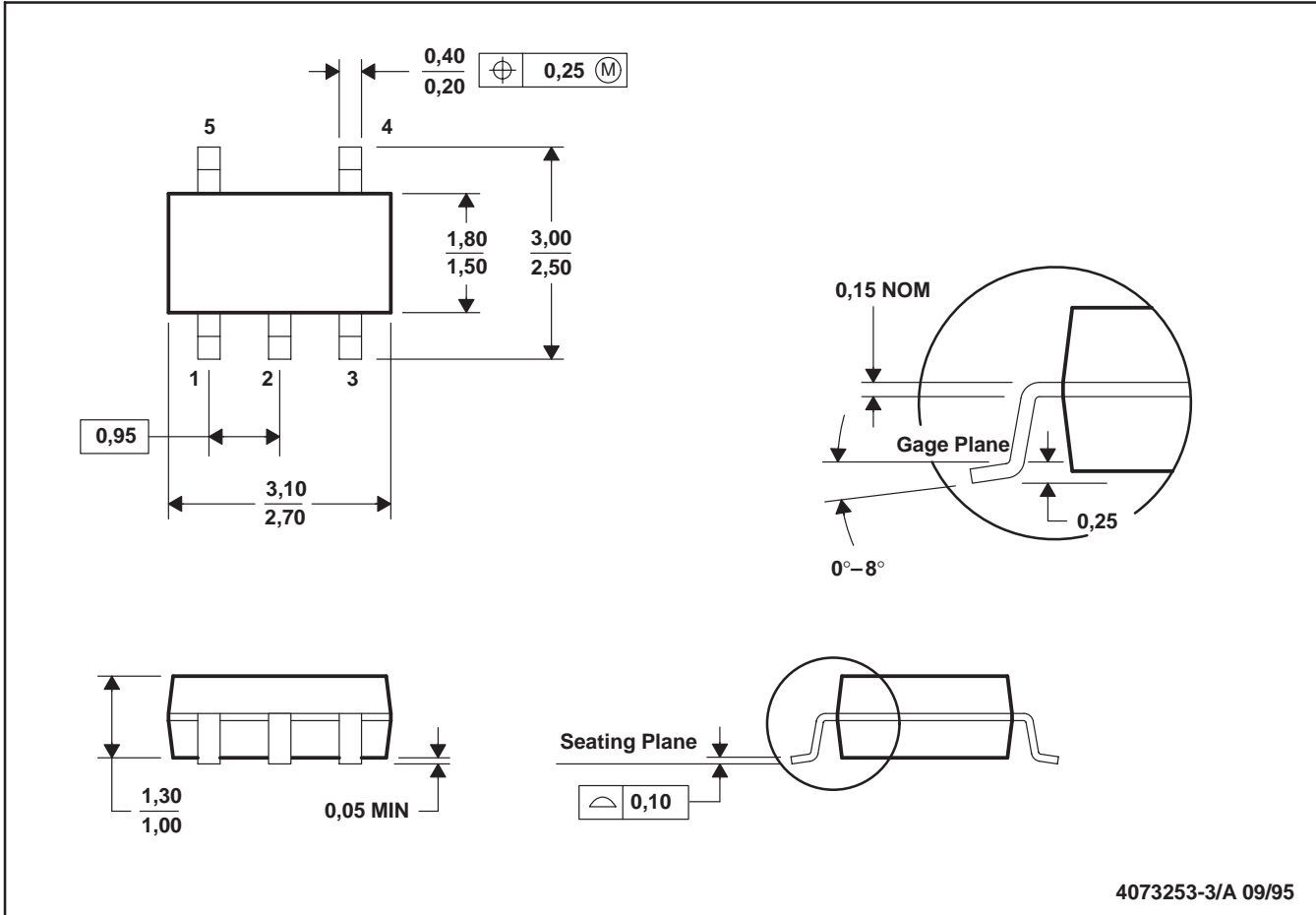

- NOTES: A. All linear dimensions are in millimeters.
 B. This drawing is subject to change without notice.
 C. Body dimensions include mold flash or protrusion.

IMPORTANT NOTICE

Texas Instruments and its subsidiaries (TI) reserve the right to make changes to their products or to discontinue any product or service without notice, and advise customers to obtain the latest version of relevant information to verify, before placing orders, that information being relied on is current and complete. All products are sold subject to the terms and conditions of sale supplied at the time of order acknowledgement, including those pertaining to warranty, patent infringement, and limitation of liability.

TI warrants performance of its semiconductor products to the specifications applicable at the time of sale in accordance with TI's standard warranty. Testing and other quality control techniques are utilized to the extent TI deems necessary to support this warranty. Specific testing of all parameters of each device is not necessarily performed, except those mandated by government requirements.

CERTAIN APPLICATIONS USING SEMICONDUCTOR PRODUCTS MAY INVOLVE POTENTIAL RISKS OF DEATH, PERSONAL INJURY, OR SEVERE PROPERTY OR ENVIRONMENTAL DAMAGE ("CRITICAL APPLICATIONS"). TI SEMICONDUCTOR PRODUCTS ARE NOT DESIGNED, AUTHORIZED, OR WARRANTED TO BE SUITABLE FOR USE IN LIFE-SUPPORT DEVICES OR SYSTEMS OR OTHER CRITICAL APPLICATIONS. INCLUSION OF TI PRODUCTS IN SUCH APPLICATIONS IS UNDERSTOOD TO BE FULLY AT THE CUSTOMER'S RISK.

In order to minimize risks associated with the customer's applications, adequate design and operating safeguards must be provided by the customer to minimize inherent or procedural hazards.

TI assumes no liability for applications assistance or customer product design. TI does not warrant or represent that any license, either express or implied, is granted under any patent right, copyright, mask work right, or other intellectual property right of TI covering or relating to any combination, machine, or process in which such semiconductor products or services might be or are used. TI's publication of information regarding any third party's products or services does not constitute TI's approval, warranty or endorsement thereof.