

# Sensitive SCRs

(0.8 A to 10 A)

## General Description

The Teccor line of sensitive SCR semiconductors are half-wave unidirectional, gate-controlled rectifiers (SCR-thyristor) which complement Teccor's line of power SCRs. This group of packages offers ratings of 0.8 A to 10 A, and 200 V to 600 V with gate sensitivities of 12  $\mu$ A to 500  $\mu$ A. For gate currents in the 10 mA to 50 mA ranges, see "SCRs" section of this catalog.

The TO-220 and TO-92 are electrically isolated where the case or tab is internally isolated to allow the use of low-cost assembly and convenient packaging techniques.

Teccor's line of SCRs features glass-passivated junctions to ensure long-term device reliability and parameter stability. Teccor's glass offers a rugged, reliable barrier against junction contamination.

Tape-and-reel packaging is available for the TO-92 package. Consult the factory for more information.





Variations of devices covered in this data sheet are available for custom design applications. Consult the factory for more information.

## Features

- Electrically-isolated TO-220 package
- High voltage capability — up to 600 V
- High surge capability — up to 100 A
- Glass-passivated chip

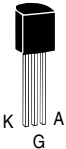
## Compak Features

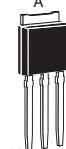
- Surface mount package — 0.8 A series
- New small-profile three-leaded Compak package
- Four gate sensitivities available
- Packaged in embossed carrier tape with 2,500 devices per reel
- Can replace SOT-223

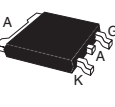
TYPE	Part Number					$I_T$		$V_{DRM}$ & $V_{RRM}$	$I_{GT}$	$I_{DRM}$ & $I_{RRM}$			$V_{TM}$
	Non-isolated					(1)				(2) (12) (14) (18)	(20) (21)		
						Amps		Volts	$\mu$ Amps	$\mu$ Amps			Volts
	See "Package Dimensions" section for variations. (11)					$I_{T(RMS)}$	$I_{T(AV)}$	MIN	MAX	$T_C$ or $T_L = 25^\circ C$	$T_C$ or $T_L = 100^\circ C$	$T_C$ or $T_L = 110^\circ C$	MAX
0.8 A				S2S1	0.8	0.51	200	12	2		100	1.7	
				S4S1	0.8	0.51	400	12	2		100	1.7	
				S6S1	0.8	0.51	600	12	2		100	1.7	
				S2S2	0.8	0.51	200	50	2		100	1.7	
				S4S2	0.8	0.51	400	50	2		100	1.7	
				S6S2	0.8	0.51	600	50	2		100	1.7	
				S2S	0.8	0.51	200	200	2		100	1.7	
				S4S	0.8	0.51	400	200	2		100	1.7	
				S6S	0.8	0.51	600	200	2		100	1.7	
				S2S3	0.8	0.51	200	500	2		100	1.7	
				S4S3	0.8	0.51	400	500	2		100	1.7	
				S6S3	0.8	0.51	600	500	2		100	1.7	
		EC103B			0.8	0.51	200	200	1	50		1.7	
		EC103D			0.8	0.51	400	200	1	50		1.7	
		EC103M			0.8	0.51	600	200	2	100		1.7	
		EC103B1			0.8	0.51	200	12	1	50		1.7	
		EC103D1			0.8	0.51	400	12	1	50		1.7	
		EC103M1			0.8	0.51	600	12	2	100		1.7	
		EC103B2			0.8	0.51	200	50	1	50		1.7	
		EC103D2			0.8	0.51	400	50	1	50		1.7	
	EC103M2			0.8	0.51	600	50	2	100		1.7		
	EC103B3			0.8	0.51	200	500	1	50		1.7		
	EC103D3			0.8	0.51	400	500	1	50		1.7		
	EC103M3			0.8	0.51	600	500	2	100		1.7		
	2N5064			0.8	0.51	200	200	1		50	1.7		
	2N6565			0.8	0.51	400	200	1		100	1.7		
1.5 A				TCR22-4	1.5	0.95	200	200	1		100	1.5	
				TCR22-6	1.5	0.95	400	200	1		100	1.5	
				TCR22-8	1.5	0.95	600	200	2		100	1.5	
4 A		T106B1			4	2.5	200	200	2		100	2.2	
		T106D1			4	2.5	400	200	2		100	2.2	
		T106M1			4	2.5	600	200	2		100	2.2	
		T107B1			4	2.5	200	500	2		100	2.5	
		T107D1			4	2.5	400	500	2		100	2.5	
		T107M1			4	2.5	600	500	2		100	2.5	
			S2004VS1	S2004DS1	4	2.5	200	50	2		100	1.6	
			S4004VS1	S4004DS1	4	2.5	400	50	2		100	1.6	
			S6004VS1	S6004DS1	4	2.5	600	50	2		100	1.6	
			S2004VS2	S2004DS2	4	2.5	200	200	2		100	1.6	
		S4004VS2	S4004DS2	4	2.5	400	200	2		100	1.6		
		S6004VS2	S6004DS2	4	2.5	600	200	2		100	1.6		

See "General Notes" on page E5 - 4 and "Electrical Specifications Notes" on page E5 - 5

V <sub>GT</sub>			I <sub>H</sub>	I <sub>GM</sub>	V <sub>GRM</sub>	P <sub>GM</sub>	P <sub>G(AV)</sub>	I <sub>TSM</sub>	dv/dt		di/dt	t <sub>gt</sub>	t <sub>q</sub>	I <sup>2</sup> t
(4) (12) (22)			(5) (15) (16) (19)	(17)		(17)		(6) (7) (13)				(8)	(9)	
Volts								Amps						
T <sub>C</sub> or T <sub>L</sub> = -40 °C	T <sub>C</sub> or T <sub>L</sub> = 25 °C	T <sub>C</sub> or T <sub>L</sub> = 110 °C	mAmps	Amps	Volts	Watts	Watts	60/50 Hz		Volts/μSec	Amps/μSec	μSec	μSec	Amps <sup>2</sup> /Sec
MAX			MAX		MIN				MIN	TYP (23)		TYP	MAX	
1.2	0.8	0.2	5	1	5	1	0.1	20/16	20		50	2	60	1.6
1.2	0.8	0.2	5	1	5	1	0.1	20/16	20		50	2	60	1.6
1.2	0.8	0.2	5	1	5	1	0.1	20/16	10		50	2	60	1.6
1.2	0.8	0.25	5	1	5	1	0.1	20/16	25		50	3	60	1.6
1.2	0.8	0.25	5	1	5	1	0.1	20/16	25		50	3	60	1.6
1.2	0.8	0.25	5	1	5	1	0.1	20/16	10		50	3	60	1.6
1.2	0.8	0.25	5	1	5	1	0.1	20/16	30		50	4	50	1.6
1.2	0.8	0.25	5	1	5	1	0.1	20/16	30		50	4	50	1.6
1.2	0.8	0.25	5	1	5	1	0.1	20/16	15		50	4	50	1.6
1.2	0.8	0.25	8	1	5	1	0.1	20/16	40		50	5	45	1.6
1.2	0.8	0.25	8	1	5	1	0.1	20/16	40		50	5	45	1.6
1.2	0.8	0.25	8	1	5	1	0.1	20/16	20		50	5	45	1.6
1.2	0.8	0.25	5	1	5	1	0.1	20/16	30		50	3.5	50	1.6
1.2	0.8	0.25	5	1	5	1	0.1	20/16	30		50	3.5	50	1.6
1.2	0.8	0.25	5	1	5	1	0.1	20/16	15		50	3.5	50	1.6
1.2	0.8	0.2	5	1	5	1	0.1	20/16	20		50	2	60	1.6
1.2	0.8	0.2	5	1	5	1	0.1	20/16	20		50	2	60	1.6
1.2	0.8	0.2	5	1	5	1	0.1	20/16	10		50	2	60	1.6
1.2	0.8	0.25	5	1	5	1	0.1	20/16	25		50	3	60	1.6
1.2	0.8	0.25	5	1	5	1	0.1	20/16	25		50	3	60	1.6
1.2	0.8	0.25	5	1	5	1	0.1	20/16	10		50	3	60	1.6
1.2	0.8	0.25	8	1	5	1	0.1	20/16	40		50	5	45	1.6
1.2	0.8	0.25	8	1	5	1	0.1	20/16	40		50	5	45	1.6
1.2	0.8	0.25	8	1	5	1	0.1	20/16	20		50	5	45	1.6
1.2	0.8	0.25	5	1	5	1	0.1	20/16	25		50	2.2	60	1.6
1.2	0.8	0.25	5	1	6	1	0.1	20/16	25		50	2.2	60	1.6
1	0.8	0.25	5	1	6	1	0.1	20/16	60		50	3.5	50	1.6
1	0.8	0.25	5	1	6	1	0.1	20/16	40		50	3.5	50	1.6
1	0.8	0.25	5	1	6	1	0.1	20/16	30		50	3.5	50	1.6
1	0.8	0.2	5	1	6	1	0.1	20/16		8	50	4	50	1.6
1	0.8	0.2	5	1	6	1	0.1	20/16		8	50	4	50	1.6
1	0.8	0.2	5	1	6	1	0.1	20/16		8	50	4	50	1.6
1	0.8	0.2	6	1	6	1	0.1	20/16		8	50	5	45	1.6
1	0.8	0.2	6	1	6	1	0.1	20/16		8	50	5	45	1.6
1	0.8	0.2	6	1	6	1	0.1	20/16		8	50	5	45	1.6
1	0.8	0.2	4	1	6	1	0.1	30/25		8	50	3	50	3.7
1	0.8	0.2	4	1	6	1	0.1	30/25		8	50	3	50	3.7
1	0.8	0.2	4	1	6	1	0.1	30/25		8	50	3	50	3.7
1	0.8	0.2	6	1	6	1	0.1	30/25		8	50	4	50	3.7
1	0.8	0.2	6	1	6	1	0.1	30/25		8	50	4	50	3.7
1	0.8	0.2	6	1	6	1	0.1	30/25		8	50	4	50	3.7

See "General Notes" on page E5 - 4 and "Electrical Specifications Notes" on page E5 - 5

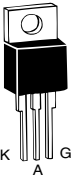
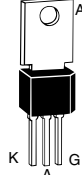
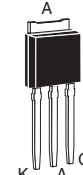
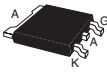
TYPE	Part Number				$I_T$		$V_{DRM}$ & $V_{RRM}$	$I_{GT}$	$I_{DRM}$ & $I_{RRM}$		$V_{TM}$
	Isolated	Non-isolated									
					(1)			(2) (12)	(20) (21)		(3) (10)
	TO-220	TO-202	TO-251 V-Pak	TO-252 D-Pak	Amps				μAmps		
See "Package Dimensions" section for variations. (11)				$I_{T(RMS)}$	$I_{T(AV)}$	Volts	μAmps	$T_C = 25\text{ }^\circ\text{C}$	$T_C = 110\text{ }^\circ\text{C}$	Volts	
				MAX	MAX	MIN	MAX	MAX	MAX	MAX	
6 A	S2006LS2	S2006FS21	S2006VS2	S2006DS2	6	3.8	200	200	5	250	1.6
	S4006LS2	S4006FS21	S4006VS2	S4006DS2	6	3.8	400	200	5	250	1.6
	S6006LS2	S6006FS21	S6006VS2	S6006DS2	6	3.8	600	200	5	250	1.6
	S2006LS3	S2006FS31	S2006VS3	S2006DS3	6	3.8	200	500	5	250	1.6
	S4006LS3	S4006FS31	S4006VS3	S4006DS3	6	3.8	400	500	5	250	1.6
	S6006LS3	S6006FS31	S6006VS3	S6006DS3	6	3.8	600	500	5	250	1.6
8 A	S2008LS2	S2008FS21	S2008VS2	S2008DS2	8	5.1	200	200	5	250	1.6
	S4008LS2	S4008FS21	S4008VS2	S4008DS2	8	5.1	400	200	5	250	1.6
	S6008LS2	S6008FS21	S6008VS2	S6008DS2	8	5.1	600	200	5	250	1.6
	S2008LS3	S2008FS31	S2008VS3	S2008DS3	8	5.1	200	500	5	250	1.6
	S4008LS3	S4008FS31	S4008VS3	S4008DS3	8	5.1	400	500	5	250	1.6
	S6008LS3	S6008FS31	S6008VS3	S6008DS3	8	5.1	600	500	5	250	1.6
10 A	S2010LS2	S2010FS21	S2010VS2	S2010DS2	10	6.4	200	200	5	250	1.6
	S4010LS2	S4010FS21	S4010VS2	S4010DS2	10	6.4	400	200	5	250	1.6
	S6010LS2	S6010FS21	S6010VS2	S6010DS2	10	6.4	600	200	5	250	1.6
	S2010LS3	S2010FS31	S2010VS3	S2010DS3	10	6.4	200	500	5	250	1.6
	S4010LS3	S4010FS31	S4010VS3	S4010DS3	10	6.4	400	500	5	250	1.6
	S6010LS3	S6010FS31	S6010VS3	S6010DS3	10	6.4	600	500	5	250	1.6

### Specific Test Conditions

- $di/dt$  — Maximum rate-of-change of on-state current;  $I_{GT} = 50$  mA pulse width  $\geq 15$  μsec with  $\leq 0.1$  μs rise time
- $dv/dt$  — Critical rate-of-rise of forward off-state voltage
- $I^2t$  — RMS surge (non-repetitive) on-state current for period of 8.3 ms for fusing
- $I_{DRM}$  and  $I_{RRM}$  — Peak off-state current at  $V_{DRM}$  and  $V_{RRM}$
- $I_{GT}$  — DC gate trigger current  $V_D = 6$  V dc;  $R_L = 100 \Omega$
- $I_{GM}$  — Peak gate current
- $I_H$  — DC holding current; initial on-state current = 20 mA
- $I_T$  — Maximum on-state current
- $I_{TSM}$  — Peak one-cycle forward surge current
- $P_{G(AV)}$  — Average gate power dissipation
- $P_{GM}$  — Peak gate power dissipation
- $t_{gt}$  — Gate controlled turn-on time gate pulse = 10 mA; minimum width = 15 μs with rise time  $\leq 0.1$  μs
- $t_q$  — Circuit commutated turn-off time
- $V_{DRM}$  and  $V_{RRM}$  — Repetitive peak off-state forward and reverse voltage
- $V_{GRM}$  — Peak reverse gate voltage
- $V_{GT}$  — DC gate trigger voltage;  $V_D = 6$  V dc;  $R_L = 100 \Omega$
- $V_{TM}$  — Peak on-state voltage





### General Notes

- Teccor 2N5064 and 2N6565 Series devices conform to all JEDEC registered data. See specifications table on pages E5 - 2 and E5 - 3.
- The case lead temperature ( $T_C$  or  $T_L$ ) is measured as shown on dimensional outline drawings in the "Package Dimensions" section of this catalog.
- All measurements (except  $I_{GT}$ ) are made with an external resistor  $R_{GK} = 1$  kΩ unless otherwise noted.
- All measurements are made at 60 Hz with a resistive load at an ambient temperature of +25 °C unless otherwise specified.
- Operating temperature ( $T_J$ ) is -65 °C to +110 °C for EC Series devices, -65 °C to +125 °C for 2N Series devices, -40 °C to +125 °C for "TCR" Series, and -40 °C to +110 °C for all others.
- Storage temperature range ( $T_S$ ) is -65 °C to +150 °C for TO-92 devices, -40 °C to +150 °C for TO-202 and Compak devices, and -40 °C to +125 °C for all others.
- Lead solder temperature is a maximum of +230 °C for 10 seconds maximum  $\geq 1/16"$  (1.59 mm) from case.

V <sub>GT</sub>			I <sub>H</sub>	I <sub>GM</sub>	V <sub>GRM</sub>	P <sub>GM</sub>	P <sub>G(AV)</sub>	I <sub>TSM</sub>	dv/dt	di/dt	t <sub>gt</sub>	t <sub>q</sub>	I <sup>2</sup> t
(4) (12) (22)			(5) (19)	(17)		(17)		(6) (13)			(8)	(9)	
Volts									Volts/μSec				
T <sub>C</sub> = -40 °C	T <sub>C</sub> = 25 °C	T <sub>C</sub> = 110 °C	mAmps	Amps	Volts	Watts	Watts	Amps	T <sub>C</sub> = 110 °C	Amps/μSec	μSec	μSec	Amps <sup>2</sup> Sec
MAX			MAX		MIN			60/50 Hz	TYP		TYP	MAX	
1	0.8	0.25	6	1	6	1	0.1	100/83	10	100	4	50	41
1	0.8	0.25	6	1	6	1	0.1	100/83	8	100	4	50	41
1	0.8	0.25	6	1	6	1	0.1	100/83	8	100	4	50	41
1	0.8	0.25	8	1	6	1	0.1	100/83	10	100	5	45	41
1	0.8	0.25	8	1	6	1	0.1	100/83	8	100	5	45	41
1	0.8	0.25	8	1	6	1	0.1	100/83	8	100	5	45	41
1	0.8	0.25	6	1	6	1	0.1	100/83	10	100	4	50	41
1	0.8	0.25	6	1	6	1	0.1	100/83	8	100	4	50	41
1	0.8	0.25	6	1	6	1	0.1	100/83	8	100	4	50	41
1	0.8	0.25	8	1	6	1	0.1	100/83	10	100	5	45	41
1	0.8	0.25	8	1	6	1	0.1	100/83	8	100	5	45	41
1	0.8	0.25	8	1	6	1	0.1	100/83	8	100	5	45	41
1	0.8	0.25	6	1	6	1	0.1	100/83	10	100	4	50	41
1	0.8	0.25	6	1	6	1	0.1	100/83	8	100	4	50	41
1	0.8	0.25	6	1	6	1	0.1	100/83	8	100	4	50	41
1	0.8	0.25	8	1	6	1	0.1	100/83	10	100	5	45	41
1	0.8	0.25	8	1	6	1	0.1	100/83	8	100	5	45	41
1	0.8	0.25	8	1	6	1	0.1	100/83	8	100	5	45	41

## Electrical Specifications Notes

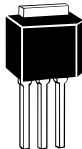
- (1) See Figure E5.1 through Figure E5.9 for current ratings at specified operating temperatures.
- (2) See Figure E5.10 for I<sub>GT</sub> versus T<sub>C</sub> or T<sub>L</sub>.
- (3) See Figure E5.11 for instantaneous on-state current (I<sub>T</sub>) versus on-state voltage (V<sub>T</sub>) TYP.
- (4) See Figure E5.12 for V<sub>GT</sub> versus T<sub>C</sub> or T<sub>L</sub>.
- (5) See Figure E5.13 for I<sub>H</sub> versus T<sub>C</sub> or T<sub>L</sub>.
- (6) For more than one full cycle, see Figure E5.14.
- (7) 0.8 A to 4 A devices also have a pulse peak forward current on-state rating (repetitive) of 75 A. This rating applies for operation at 60 Hz, 75 °C maximum tab (or anode) lead temperature, switching from 80 V peak, sinusoidal current pulse width of 10 μs minimum, 15 μs maximum. See Figure E5.20 and Figure E5.21.
- (8) See Figure E5.15 for t<sub>gt</sub> versus I<sub>GT</sub>.
- (9) Test conditions as follows:
  - T<sub>C</sub> or T<sub>L</sub> ≤ 80 °C, rectangular current waveform
  - Rate-of-rise of current ≤ 10 A/μs
  - Rate-of-reversal of current ≤ 5 A/μs
  - I<sub>TM</sub> = 1 A (50 μs pulse), Repetition Rate = 60 pps
  - V<sub>RRM</sub> = Rated
  - V<sub>R</sub> = 15 V minimum, V<sub>DRM</sub> = Rated
  - Rate-of-rise reapplied forward blocking voltage = 5 V/μs
  - Gate Bias = 0 V, 100 Ω (during turn-off time interval)
- (10) Test condition is maximum rated RMS current except TO-92 devices are 1.2 A<sub>PK</sub>; T106/T107 devices are 4 A<sub>PK</sub>.
- (11) See package outlines for lead form configurations. When ordering special lead forming, add type number as suffix to part number.
- (12) V<sub>D</sub> = 6 V dc, R<sub>L</sub> = 100 Ω (See Figure E5.19 for simple test circuit for measuring gate trigger voltage and gate trigger current.)
- (13) See Figure E5.1 through Figure E5.9 for maximum allowable case temperature at maximum rated current.
- (14) I<sub>GT</sub> = 500 μA maximum at T<sub>C</sub> = -40 °C for T106 devices
- (15) I<sub>H</sub> = 10 mA maximum at T<sub>C</sub> = -65 °C for 2N5064 Series and 2N6565 Series devices
- (16) I<sub>H</sub> = 6 mA maximum at T<sub>C</sub> = -40 °C for T106 devices
- (17) Pulse Width ≤ 10 μs
- (18) I<sub>GT</sub> = 350 μA maximum at T<sub>C</sub> = -65 °C for 2N5064 Series and 2N6565 Series devices
- (19) Latching current can be higher than 20 mA for higher I<sub>GT</sub> types. Also, latching current can be much higher at -40 °C. See Figure E5.18.
- (20) T<sub>C</sub> or T<sub>L</sub> = T<sub>J</sub> for test conditions in off state
- (21) I<sub>DRM</sub> and I<sub>RRM</sub> = 50 μA for 2N5064 and 100 μA for 2N6565 at 125 °C
- (22) TO-92 devices specified at -65 °C instead of -40 °C
- (23) T<sub>C</sub> = 110 °C

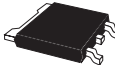
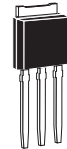
Thermal Resistance (Steady State) $R_{\theta JC}$ [ $R_{\theta JA}$ ] °C/W (TYPICAL)							
Package Code	E	L	F2	F	C	D	V
Type	 TO-92	 TO-220	 TO-202 Type 2, 4, & 41	 TO-202 Type 1 & 3	 Compak	 TO-252 D-Pak	 TO-251 V-Pak
0.8 A	75 [160]				60*		
1.5 A	50 [160]						
4.0 A			10 [100]	6.2 [80]		3.0	3.8 [85]
6.0 A		4.0 [65]		4.3		1.8	2.4
8.0 A		3.4		3.9		1.5	2.1
10.0 A		3.0		3.4		1.45	1.72

\*Mounted on 1 cm<sup>2</sup> copper foil surface; two-ounce copper foil

### Electrical Isolation

Teccor's isolated sensitive SCRs will withstand a minimum high potential test of 2500 V ac rms from leads to mounting tab over the device's operating temperature range. The following table shows other standard and optional isolation ratings.

Electrical Isolation * from Leads to Mounting Tab	
V AC RMS	TO-220
2500	Standard
4000	Optional **

\*UL Recognized File #E71639

\*\*For 4000 V isolation, use "V" suffix in part number.

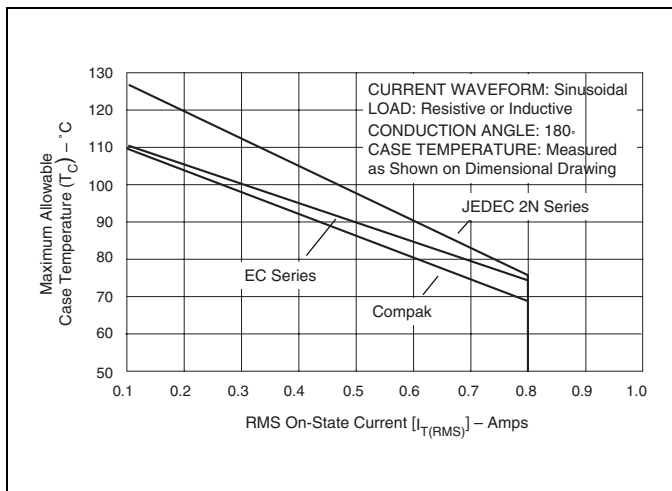

Figure E5.1 Maximum Allowable Case Temperature versus RMS On-state Current

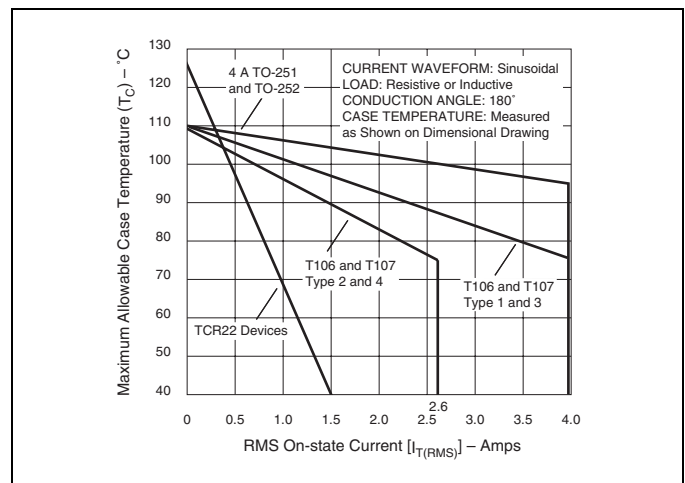

Figure E5.2 Maximum Allowable Case Temperature versus RMS On-state Current

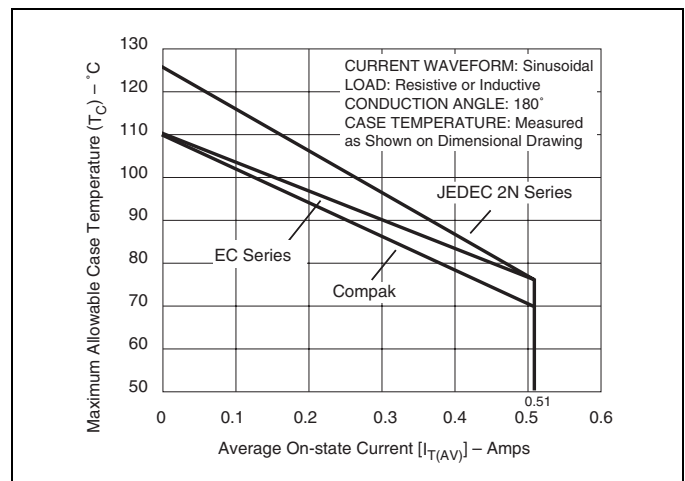

Figure E5.3 Maximum Allowable Case Temperature versus Average On-state Current

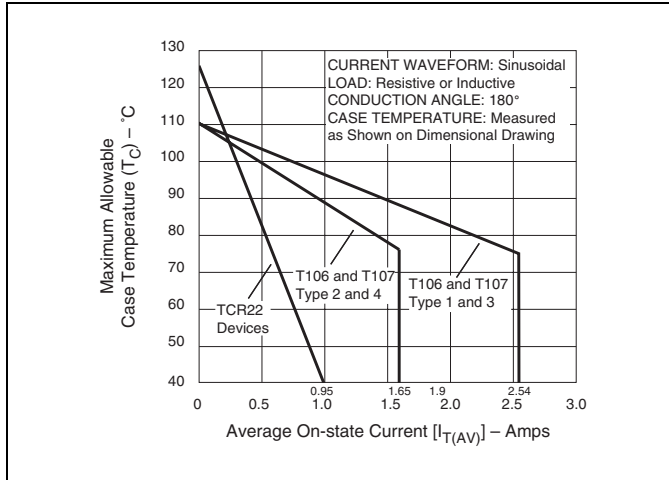

Figure E5.4 Maximum Allowable Case Temperature versus Average On-state Current

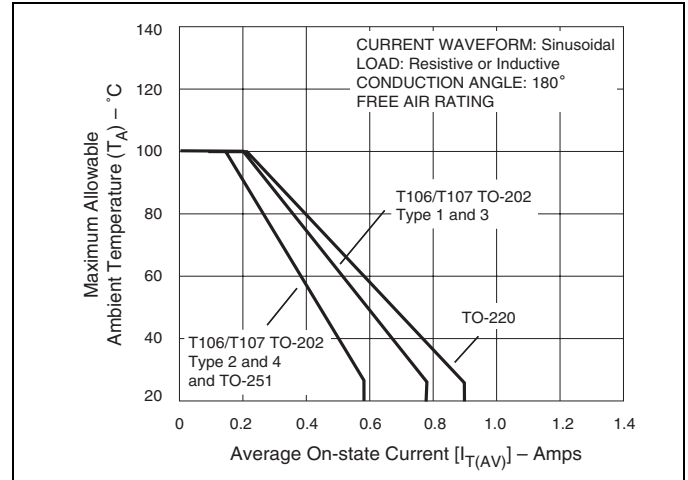

Figure E5.7 Maximum Allowable Ambient Temperature versus Average On-state Current

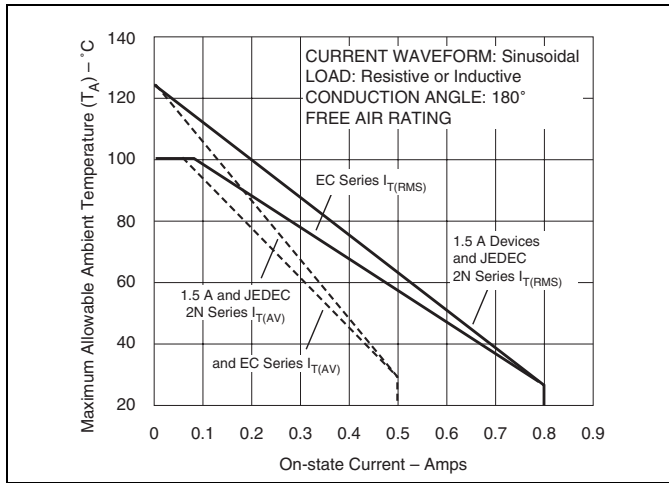

Figure E5.5 Maximum Allowable Ambient Temperature versus On-state Current

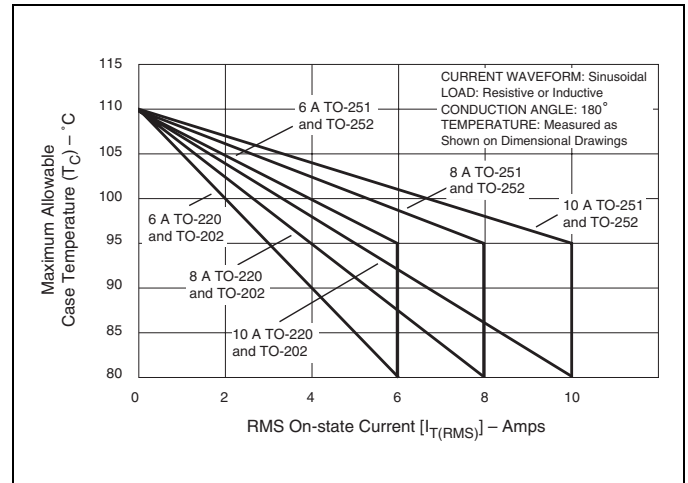

Figure E5.8 Maximum Allowable Case Temperature versus RMS On-state Current

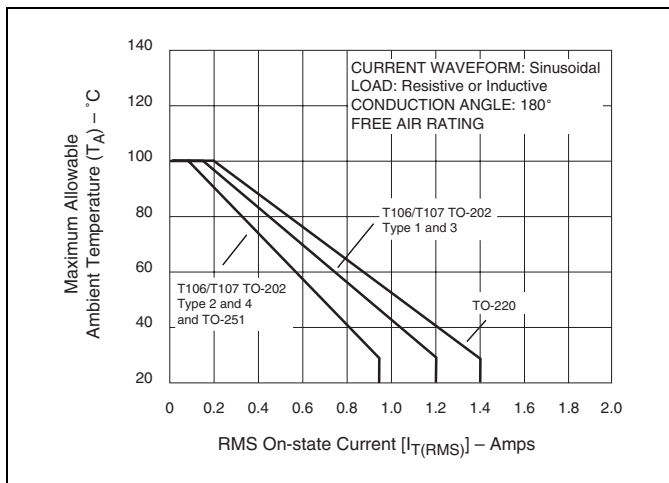

Figure E5.6 Maximum Allowable Ambient Temperature versus RMS On-state Current

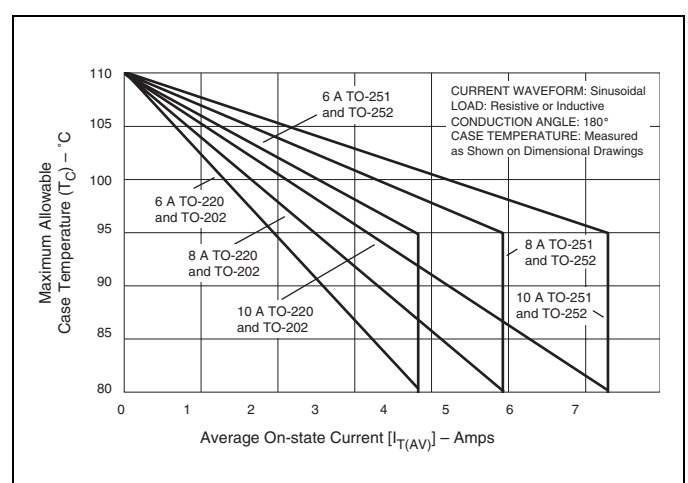

Figure E5.9 Maximum Allowable Case Temperature versus Average On-state Current

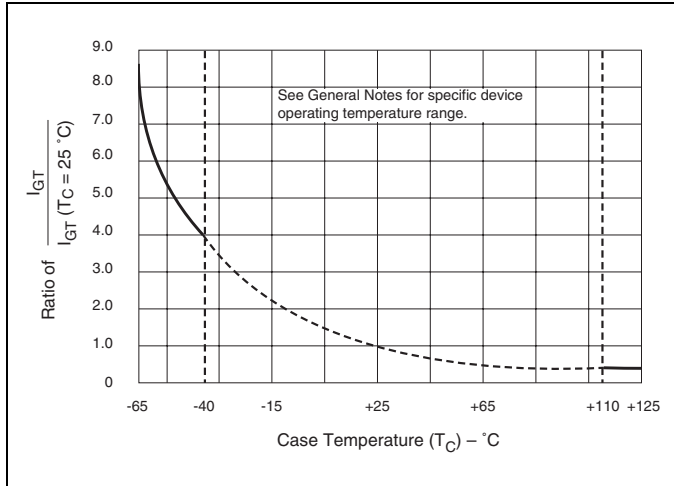

Figure E5.10 Normalized DC Gate-Trigger Current versus Case Temperature

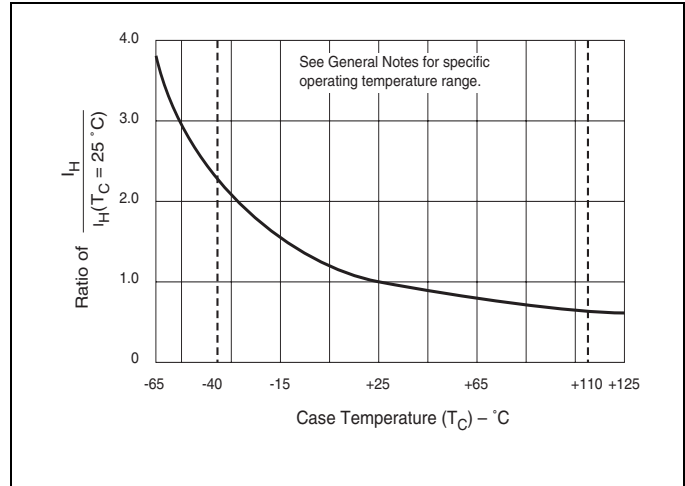

Figure E5.13 Normalized DC Holding Current versus Case Temperature

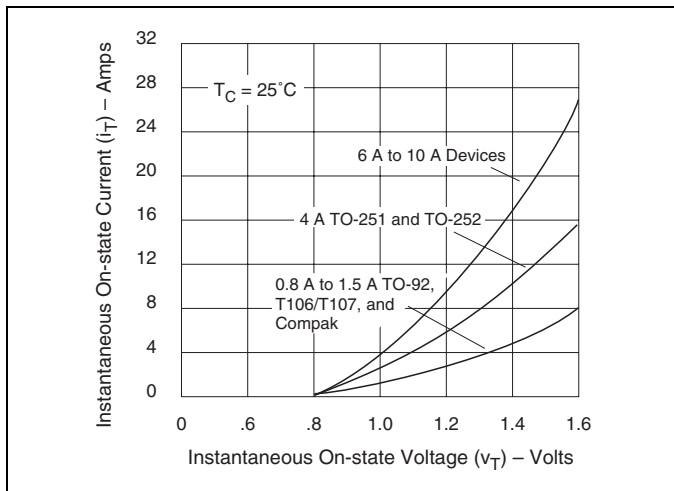

Figure E5.11 Instantaneous On-state Current versus On-state Voltage (Typical)

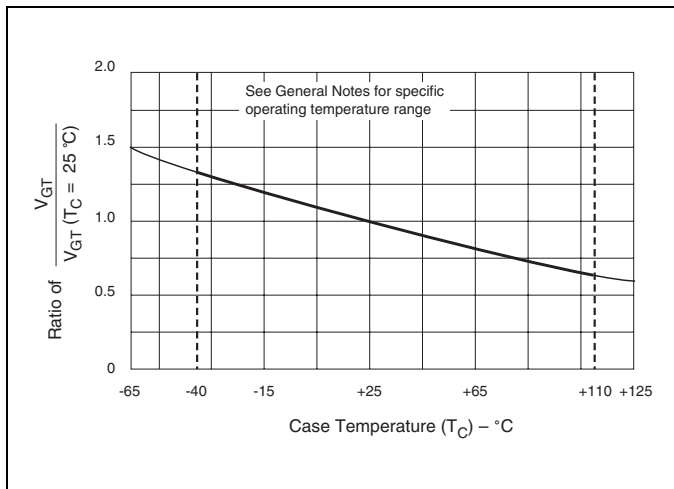

Figure E5.12 Normalized DC Gate-Trigger Voltage versus Case Temperature



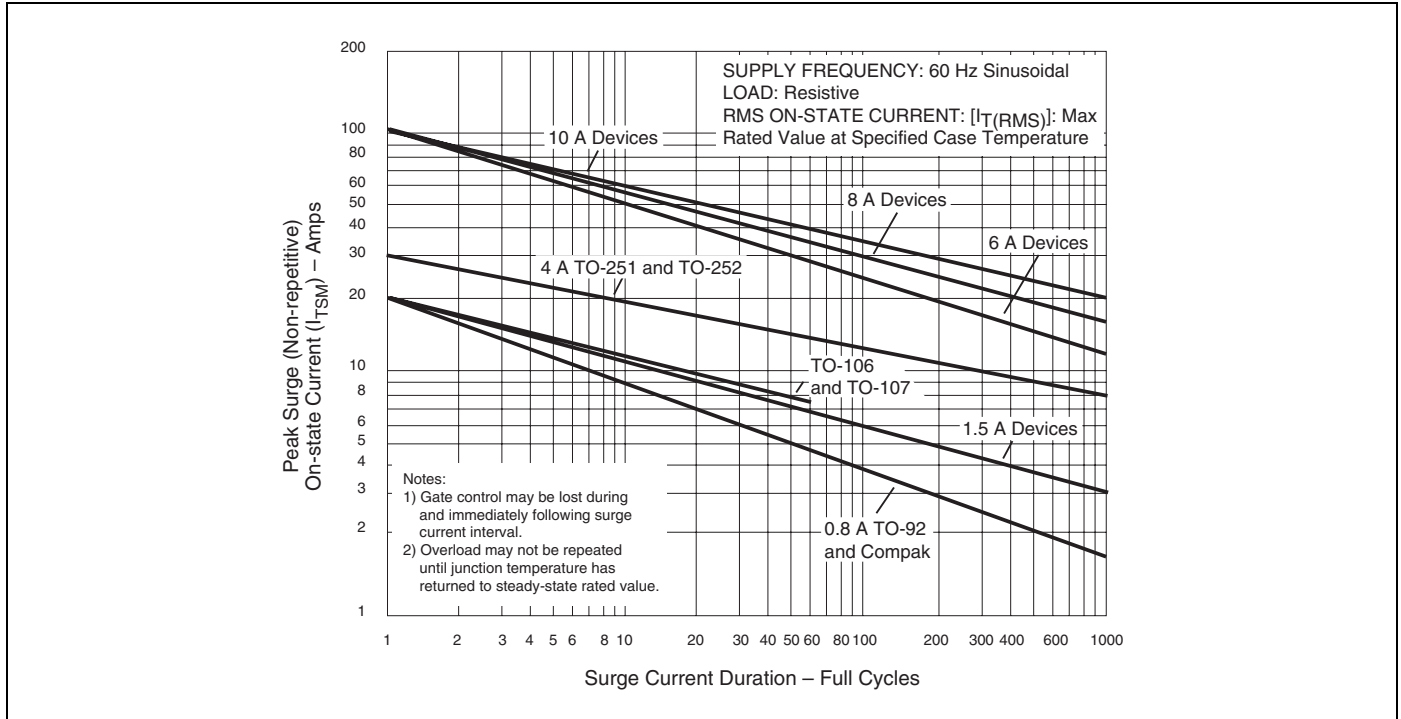

Figure E5.14 Peak Surge On-state Current versus Surge Current Duration

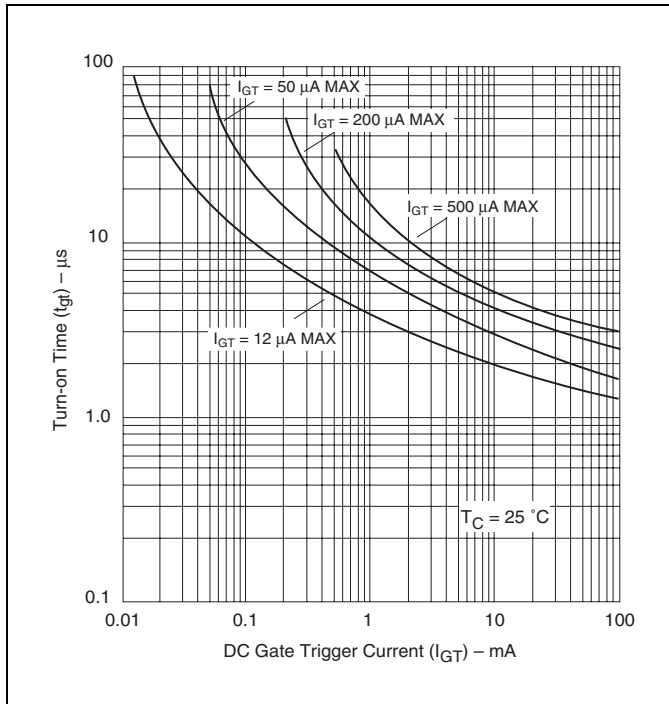

Figure E5.15 Typical Turn-on Time versus Gate Trigger Current

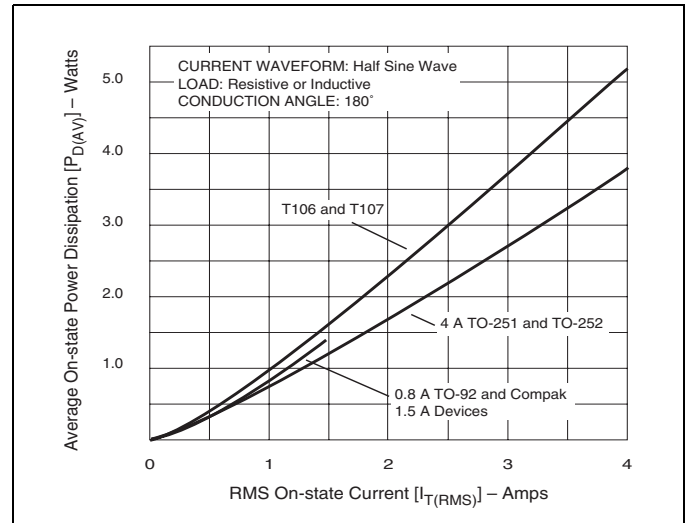

Figure E5.16 Power Dissipation (Typical) versus RMS On-state Current

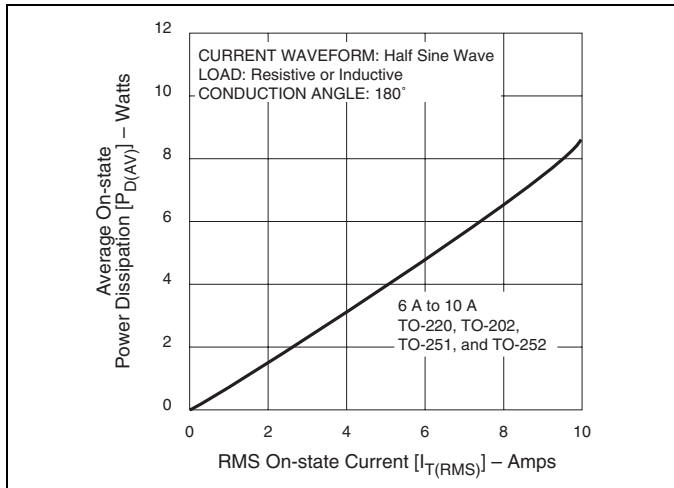

Figure E5.17 Power Dissipation (Typical) versus RMS On-state Current

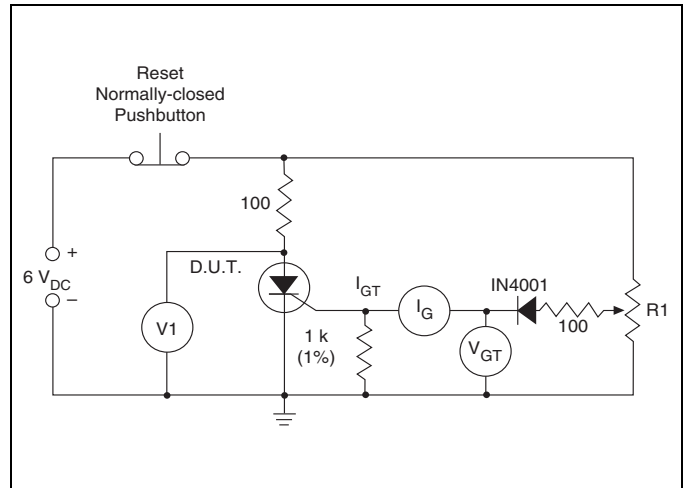

Figure E5.19 Simple Test Circuit for Gate Trigger Voltage and Current Measurement

Note: V1 — 0 V to 10 V dc meter  
 V<sub>GT</sub> — 0 V to 1 V dc meter  
 I<sub>G</sub> — 0 mA to 1 mA dc milliammeter  
 R1 — 1 k potentiometer

To measure gate trigger voltage and current, raise gate voltage (V<sub>GT</sub>) until meter reading V1 drops from 6 V to 1 V. Gate trigger voltage is the reading on V<sub>GT</sub> just prior to V1 dropping. Gate trigger current I<sub>GT</sub> can be computed from the relationship

$$I_{GT} = I_G - \frac{V_{GT}}{1000} \text{ Amps}$$

where I<sub>G</sub> is reading (in amperes) on meter just prior to V1 dropping.

Note: I<sub>GT</sub> may turn out to be a negative quantity (trigger current flows out from gate lead).

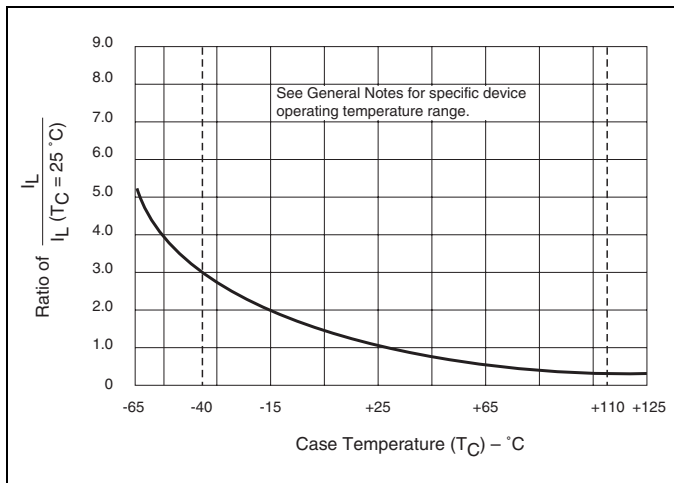

Figure E5.18 Normalized DC Latching Current versus Case Temperature

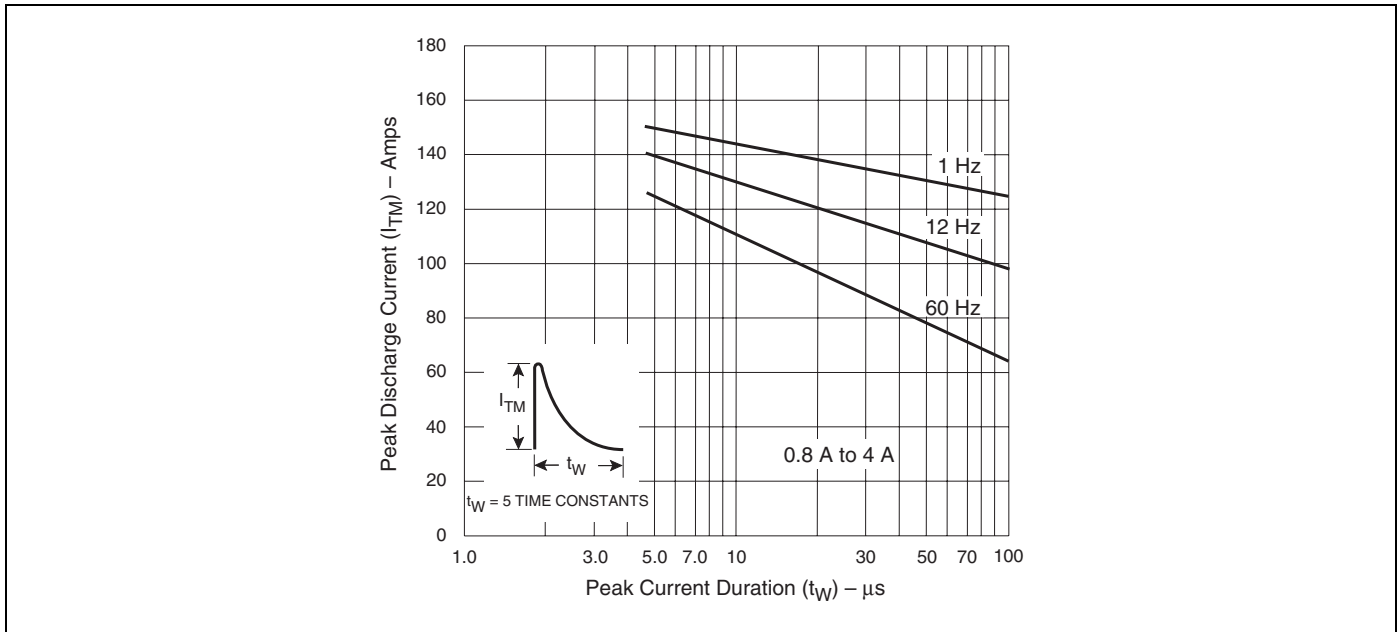

Figure E5.20 Peak Repetitive Capacitor Discharge Current

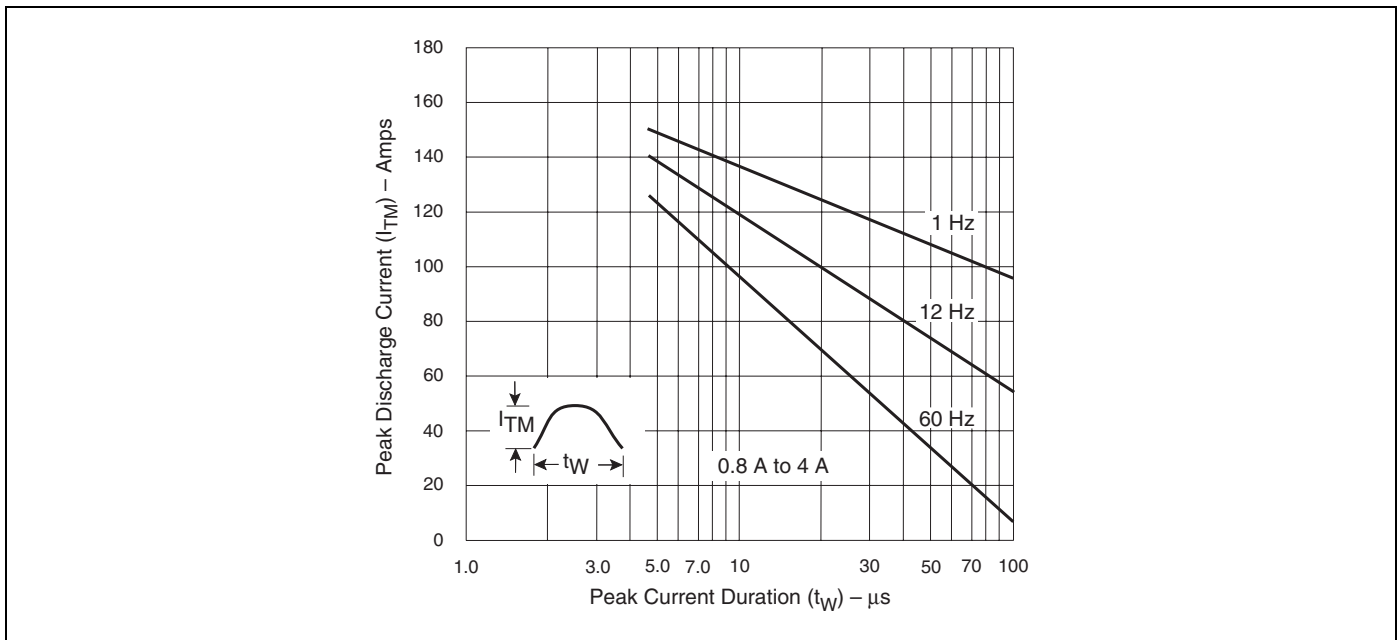

Figure E5.21 Peak Repetitive Sinusoidal Curve

