»» Features

- Mini ISO high power automotive relay 30A/50A.
- High temperature endurance up to 125 degree C.
- Optional SPNC, SPNO, SPDT, DPNO contact configurations.
- Optional to be equipped with protection diode or resistor.
- Both available PCB terminal and quick connect terminal versions.
- Available for plain cover type, skirted cover flanged cover, and weather proof versions.
- Tinned terminal is available on request.
- Comply with RoHS-Directive 2002/95/EC, and ELV-Directive 2000/53/EC.

»» Type List

Terminal style	Contact form	Enclosure style		
		Dust cover	Flux tight	Sealed type washable
Socket terminal	1A (SPNO)	896-1AH-D	896-1AH-C	896-1AH-S
		896H-1AH-D	896H-1AH-C	896H-1AH-S
	1C (SPDT)	896-1CH-D	896-1CH-C	896-1CH-S
		896H-1CH-D	896H-1CH-C	896H-1CH-S
	2A (DPNO)	896-2AH-D	896-2AH-C	896-2AH-S
		896H-2AH-D	896H-2AH-C	896H-2AH-S
PCB terminal	1A (SPNO)	896P-1AH-D	896P-1AH-C	896P-1AH-S
		896HP-1AH-D	896HP-1AH-C	896HP-1AH-S
	1C (SPDT)	896P-1CH-D	896P-1CH-C	896P-1CH-S
		896HP-1CH-D	896HP-1CH-C	896HP-1CH-S
	2A (DPNO)	896P-2AH-D	896P-2AH-C	896P-2AH-S
		896HP-2AH-D	896HP-2AH-C	896HP-2AH-S

Terminal style	Contact form	Enclosure style	
		Flanged cover (dust cover)	Flanged cover (flux tight)
Socket terminal	1A (SPNO)	896-1AH-D1	896-1AH-C1
		896H-1AH-D1	896H-1AH-C1
	1C (SPDT)	896-1CH-D1	896-1CH-C1
		896H-1CH-D1	896H-1CH-C1
	2A (DPNO)	896-2AH-D1	896-2AH-C1
		896H-2AH-D1	896H-2AH-C1

Terminal style	Contact form	Enclosure style	
		Steel bracket (dust cover)	Steel bracket (flux tight)
Socket terminal	1A (SPNO)	896-1AH-D1S	896-1AH-C1S
		896H-1AH-D1S	896H-1AH-C1S
	1C (SPDT)	896-1CH-D1S	896-1CH-C1S
		896H-1CH-D1S	896H-1CH-C1S
	2A (DPNO)	896-2AH-D1S	896-2AH-C1S
		896H-2AH-D1S	896H-2AH-C1S

Terminal style	Contact form	Designation (provided with)	Enclosure style	
			Steel bracket (dust cover with shroud)	Steel bracket (dust cover with weather proof)
Socket terminal	1C (SPDT)	Resistor	896H-1CH-D1SF-R1	896H-1CH-D1SW-R1

»» Ordering Information

896 H P - 1CH - C - R1 - T 001
 1 2 3 4 5 6 7 8

- | | | | | | |
|----|-------|--|------|---|------------------|
| 1. | 896 | -- Basic series designation | D1S | -- Steel bracket (dust cover) | |
| 2. | Blank | -- Standard type | C1S | -- Steel bracket (flux tight) | |
| | H | -- High power type | S1S | -- Steel bracket (sealed type washable) | |
| 3. | Blank | -- Socket terminal | D1SF | -- Steel bracket (dust cover with shroud) | |
| | P | -- PCB terminal | D1SW | -- Steel bracket (dust cover with weather proof) | |
| 4. | 1AH | -- Single pole normally open, contact material AgSnO | 6. | Blank | -- Standard type |
| | 1BH | -- Single pole normally closed, contact material AgSnO | R1 | -- Coil parallel with resistor 1/2W for 12V 680Ω , 24V 2700Ω | |
| | 1CH | -- Single pole double throw, contact material AgSnO | 7. | Blank | -- Standard type |
| | 2AH | -- Double pole double make, contact material AgSnO | T | -- Special requirement for Tin plated terminal | |
| 5. | D | -- Dust cover | 8. | Blank | -- Standard type |
| | C | -- Flux tight | 001 | -- Coil parallel with diode IN4007 the positive pole "+" on # 85 terminal | |
| | S | -- Sealed type washable | 002 | -- Coil parallel with diode IN4007 the negative pole "-" on # 85 terminal | |
| | C1 | -- Flanged cover (flux tight) | | | |
| | D1 | -- Flanged cover (dust cover) | | | |
| | S1 | -- Flanged cover (sealed type washable) | | | |

»» Contact Rating

Type	896 1A	896 1B	896 1C	896 2A
Resistive load	40A 14VDC	40A 14VDC	NO : 40A 14VDC NC : 30A 14VDC	2×15A 14VDC

Type	896H 1A	896H 1B	896H 1C	896H 2A
Resistive load	50A 14VDC 20A 28VDC	40A 14VDC 15A 28VDC	NO : 50A 14VDC, 20A 28VDC NC : 30A 14VDC, 15A 28VDC	2×30A 14VDC 2×10A 28VDC

»» Coil Rating(DC)

Rated voltage (V)	Rated current ±10 % at 23°C (mA)	Coil resistance ±10 % at 23°C (Ω)	Max. continuous Voltage at 85°C ⁽¹⁾	Pick up voltage(Max) at 23°C	Drop out voltage(Min) at 23°C	Power consumption at rated voltage
12	133	90	120 % of rated voltage	65 % of rated voltage	10 % of rated voltage	approx. 1.6W
24	66.7	360				

Notes : (1) Without switching the load.

»» Specification

Contact material	AgSnO alloy	
Contact voltage drop ⁽¹⁾	Typ. 50mV at 10A	
Insulation resistance ⁽¹⁾	20MΩ Min. (DC 500V)	
Operate time ⁽¹⁾	20ms Max.	
Release time ⁽¹⁾	20ms Max.	
Dielectric strength ⁽¹⁾	Between open contact	: AC 500V , 50/60Hz 1 min.
	Between contact and coil	: AC 500V , 50/60Hz 1 min.
Vibration resistance	Operating extremes	10~55Hz , amplitude 2mm
Shock resistance	Operating extremes	10G
	Damage limits	100G
Life expectancy	Mechanical	10,000,000 operations (frequency 18,000 operations/hr)
	Electrical	100,000 operations (frequency 1,200 operations/hr)
Temperature range	Operating	-40~+125°C (no freezing)
Weight	Approx. 40 g	

Note : (1) initial value

»» Outline Dimensions

◆ 896,896H (C,D,S)

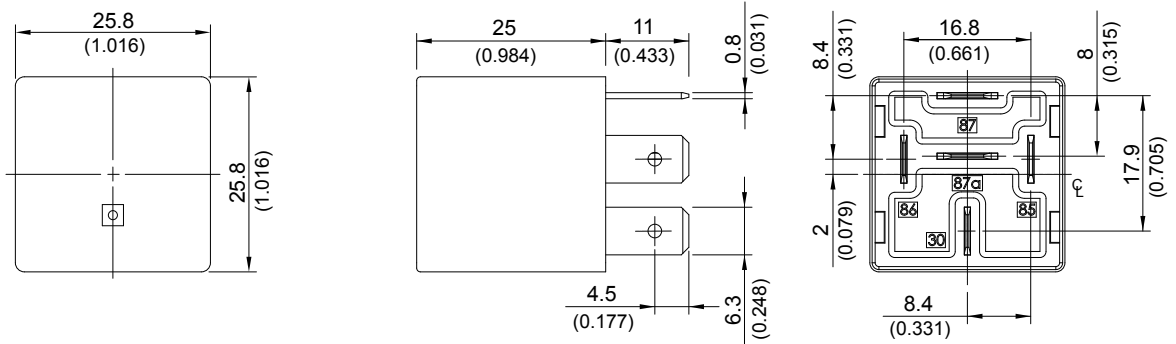

◆ 896,896H (C1,D1,S1)

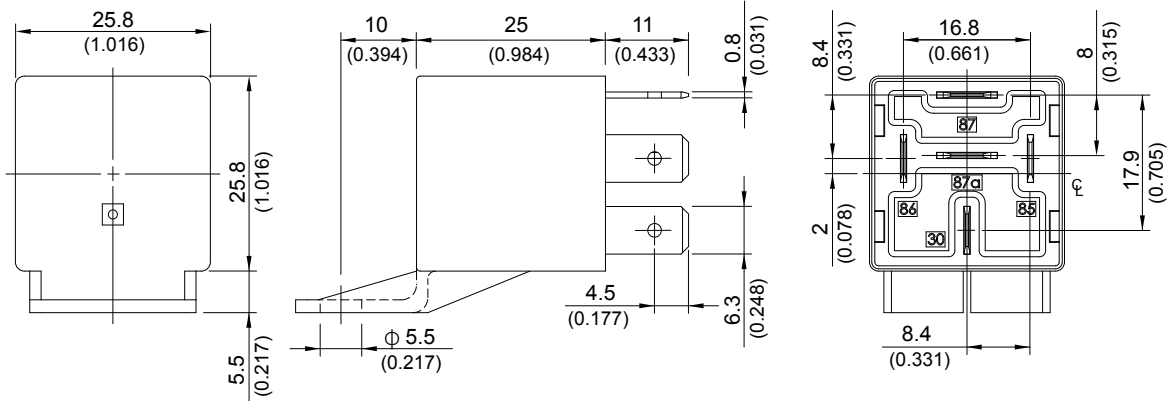

◆ 896,896H (C1S,D1S,S1S)

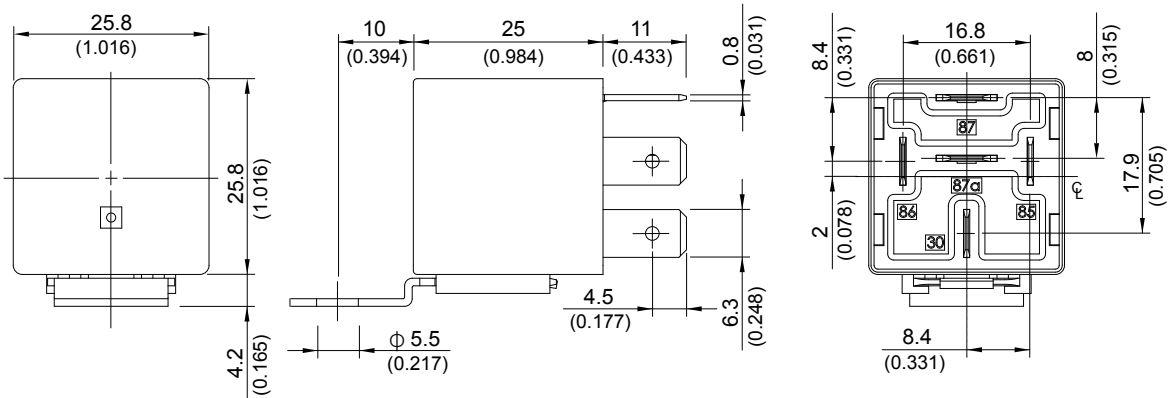

◆ 896P,896HP (C,D,S)

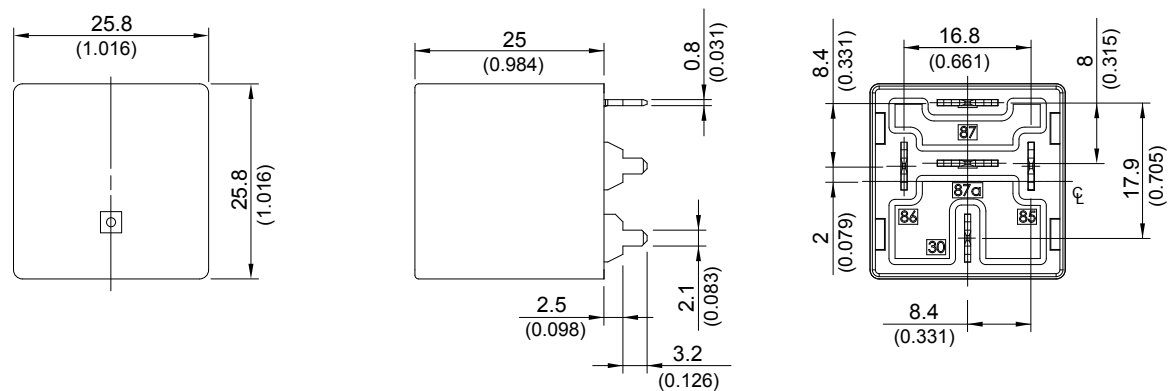

◆ 896H (D1SW)

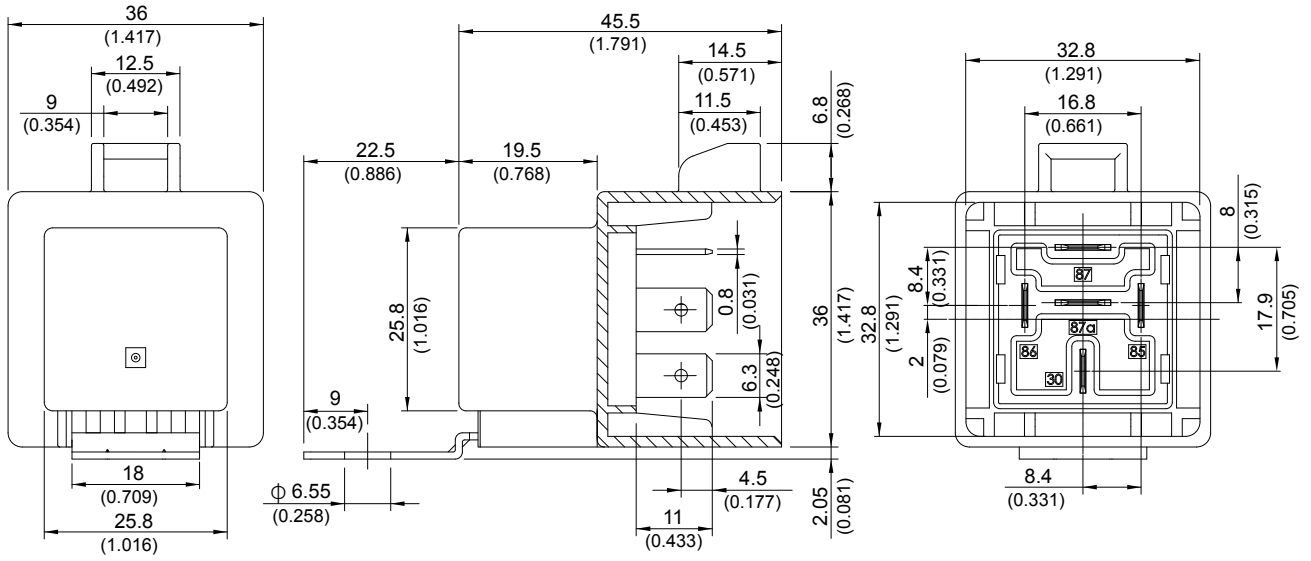

◆ 896H (D1SF)

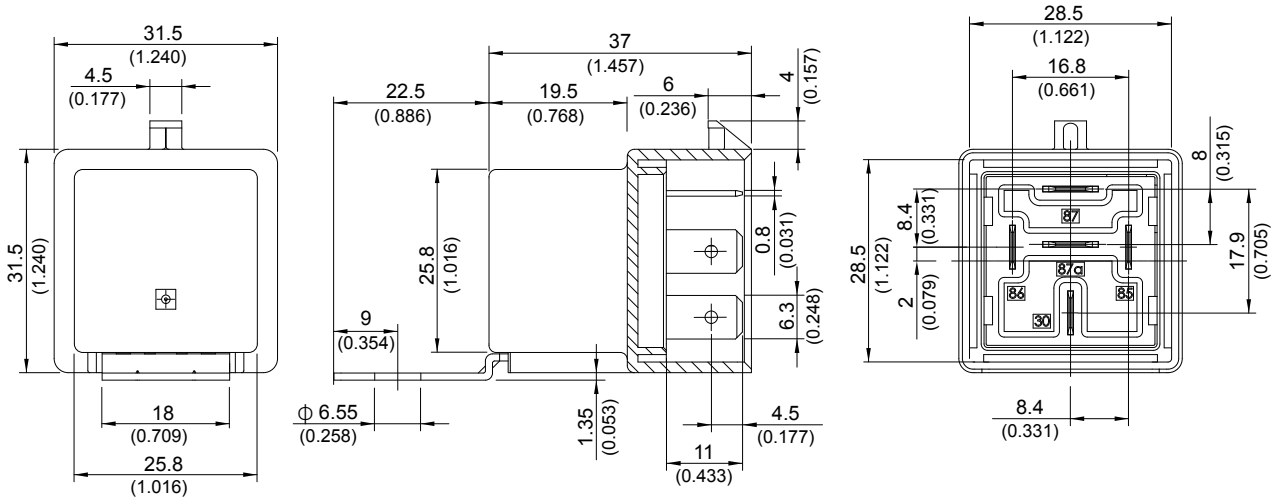

»» Wiring Diagram

BOTTOM VIEW

1A

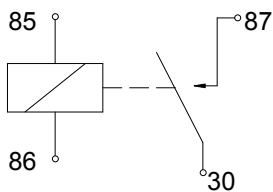

1B

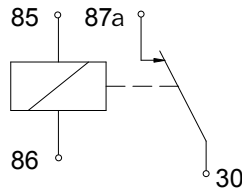

1C

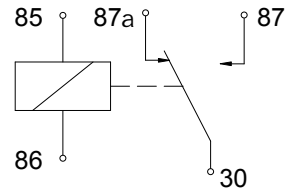

2A

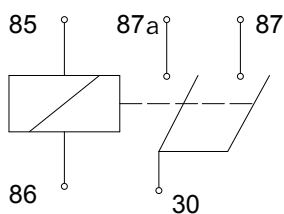

R1

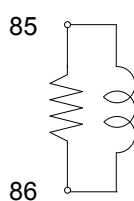

001

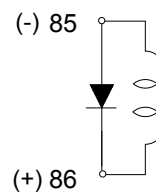

002

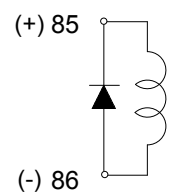

»» PC Board Layout

BOTTOM VIEW

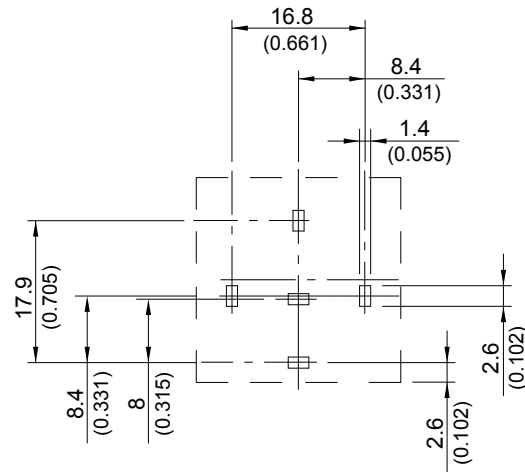

»» Engineering Data

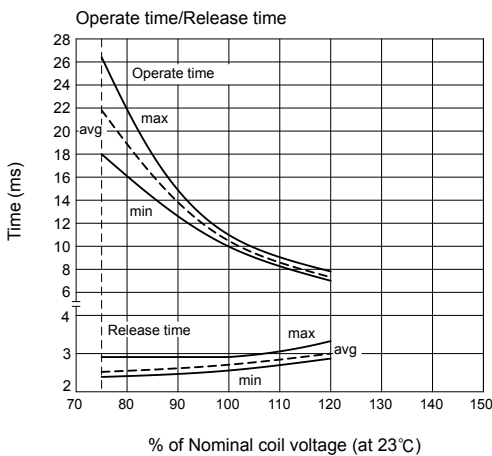
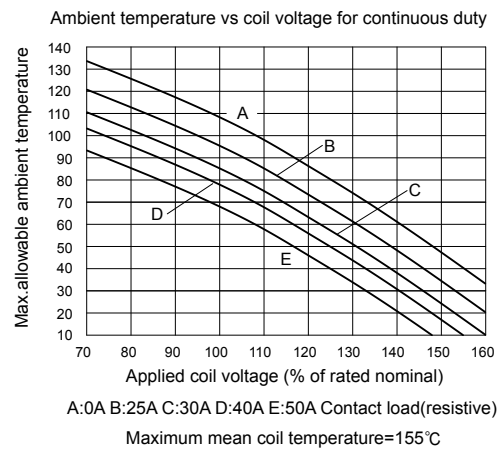
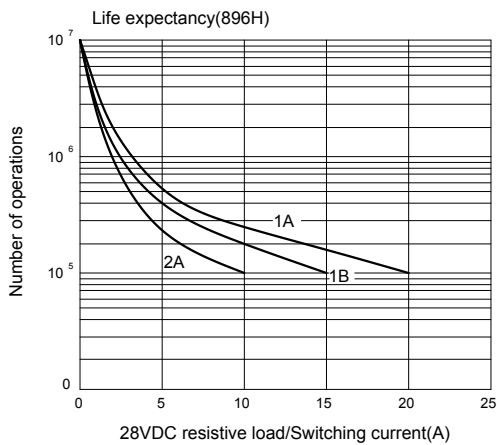
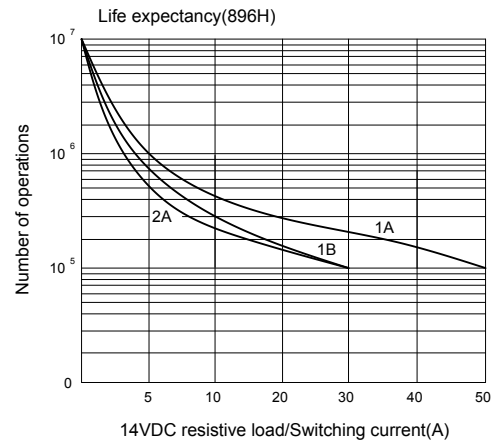
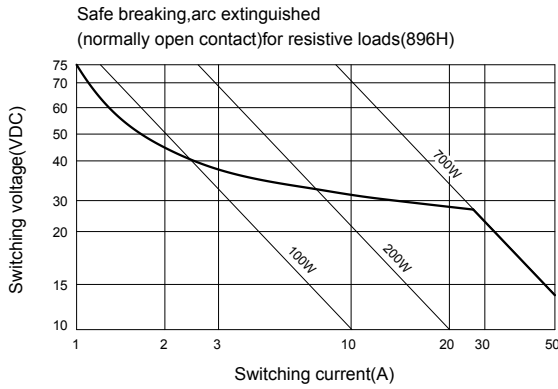

Mouser Electronics

Related Product Links

- [893-896H1AHD12VDC - Song Chuan 896H-1AH-D-12VDC](#)
- [893-896H1AHD1R112VDC - Song Chuan 896H-1AH-D1-R1-12VDC](#)
- [893-896H1AHSR112VDC - Song Chuan 896H-1AH-S-R1-12VDC](#)
- [893-896H1CHC00112 - Song Chuan 896H-1CH-C-001-12VDC](#)
- [893-896H1CHC00124 - Song Chuan 896H-1CH-C-001-24VDC](#)
- [893-896H1CHC112VDC - Song Chuan 896H-1CH-C1-12VDC](#)
- [893-896H1CHC12VDC - Song Chuan 896H-1CH-C-12VDC](#)
- [893-896H1CHC1S24VDC - Song Chuan 896H-1CH-C1S-24VDC](#)
- [893-896H1CHCR1U312VD - Song Chuan 896H-1CH-C-R1-U03-12VDC](#)
- [893-896H1CHD00112VDC - Song Chuan 896H-1CH-D-001-12VDC](#)
- [893-896H1CHD00124VDC - Song Chuan 896H-1CH-D-001-24VDC](#)
- [893-896H1CHD10124VDC - Song Chuan 896H-1CH-D1-001-24VDC](#)
- [893-896H1CHD112VDC - Song Chuan 896H-1CH-D1-12VDC](#)
- [893-896H1CHD124VDC - Song Chuan 896H-1CH-D1-24VDC](#)
- [893-896H1CHD12VDC - Song Chuan 896H-1CH-D-12VDC](#)
- [893-896H1CHD1R112VDC - Song Chuan 896H-1CH-D1-R1-12VDC](#)
- [893-896H1CHD1S12VDC - Song Chuan 896H-1CH-D1S-12VDC](#)
- [893-896H1CHD1S24VDC - Song Chuan 896H-1CH-D1S-24VDC](#)
- [893-896H1CHD1SW12VDC - Song Chuan 896H-1CH-D1SW-R1-12VDC](#)
- [893-896H1CHD1SW24VDC - Song Chuan 896H-1CH-D1SW-R1-24VDC](#)
- [893-896H1CHD24VDC - Song Chuan 896H-1CH-D-24VDC](#)
- [893-896H1CHDR112VDC - Song Chuan 896H-1CH-D-R1-12VDC](#)
- [893-896H1CHDR124VDC - Song Chuan 896H-1CH-D-R1-24VDC](#)
- [893-896H1CHS12VDC - Song Chuan 896H-1CH-S-12VDC](#)
- [893-896HP1AHD12VDC - Song Chuan 896HP-1AH-D-12VDC](#)
- [893-896HP1AHS12VDC - Song Chuan 896HP-1AH-S-12VDC](#)
- [893-896HP1CHC12VDC - Song Chuan 896HP-1CH-C-12VDC](#)
- [893-896HP1CHD12VDC - Song Chuan 896HP-1CH-D-12VDC](#)
- [893-896HP1CHD24VDC - Song Chuan 896HP-1CH-D-24VDC](#)
- [893-896HP1CHS12VDC - Song Chuan 896HP-1CH-S-12VDC](#)
- [893-896HP1CHS24VDC - Song Chuan 896HP-1CH-S-24VDC](#)