



N-Channel JFETs

PRODUCT SUMMARY						
Part Number	V _{GS(off)} (V)	V _{(BR)GSS} Min (V)	I _{DSS} Min (mA)	r _{DS(on)} Max (Ω)	I _{D(off)} Typ (pA)	t _{ON} Typ (ns)
2N4856A	-4 to -10	-40	50	25	5	4
2N4857A	-2 to -6	-40	20	40	5	4
2N4858A	-0.8 to -4	-40	8	60	5	4

FEATURES

- Low On-Resistance: 2N4856A <25 Ω
- Fast Switching—t_{ON}: 4 ns
- High Off-Isolation—I_{D(off)}: 5 pA
- Low Capacitance: 3 pF
- Low Insertion Loss

BENEFITS

- Low Error Voltage
- High-Speed Analog Circuit Performance
- Negligible "Off-Error," Excellent Accuracy
- Good Frequency Response
- Eliminates Additional Buffering

APPLICATIONS

- Analog Switches
- Choppers
- Sample-and-Hold
- Normally "On" Switches
- Current Limiters

DESCRIPTION

The 2N4856A/4857A/4858A all-purpose JFET analog switches offer low on-resistance, low capacitance, good isolation, and fast switching.

Hermetically-sealed TO-206AA (TO-18) packaging allows full military processing (see Military Information). For similar products in TO-226AA (TO-92) and SOT-23 packages, see the J/SST111 series data sheet. For similar duals, see the 2N5564/5565/5566 data sheet.

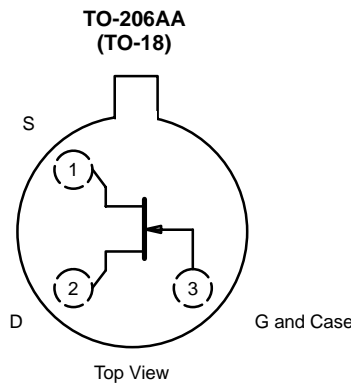



ABSOLUTE MAXIMUM RATINGS

Gate-Drain, Gate-Source Voltage : (2N4856A-58A) -40 V
 Gate Current 50 mA
 Lead Temperature ($1/16$ " from case for 10 seconds) 300 °C
 Storage Temperature -65 to 200 °C

Operating Junction Temperature -55 to 200 °C
 Power Dissipation^a 1.8 W

Notes

a. Derate 10 mW/°C for $T_C > 25$ °C

SPECIFICATIONS ($T_A = 25$ °C UNLESS OTHERWISE NOTED)											
Parameter	Symbol	Test Conditions	Typ ^a	Limits						Unit	
				2N4856A		2N4857A		2N4858A			
				Min	Max	Min	Max	Min	Max		
Static											
Gate-Source Breakdown Voltage	$V_{(BR)GSS}$	$I_G = -1 \mu A, V_{DS} = 0 V$	-55	-40		-40		-40		V	
Gate-Source Cutoff Voltage	$V_{GS(off)}$	$V_{DS} = 15 V, I_D = 0.5 nA$		-4	-10	-2	-6	-0.8	-4		
Saturation Drain Current ^b	I_{DSS}	$V_{DS} = 15 V, V_{GS} = 0 V$		50		20	100	8	80	mA	
Gate Reverse Current	I_{GSS}	$V_{GS} = -20 V, V_{DS} = 0 V$		-5		-250		-250		-250	pA
			$T_A = 150$ °C	-13		-500		-500		-500	nA
Gate Operating Current ^c	I_G	$V_{DG} = 15 V, I_D = 10 mA$	-5							pA	
Drain Cutoff Current	$I_{D(off)}$	$V_{DS} = 15 V, V_{GS} = -10 V$		5		250		250		250	pA
			$T_A = 150$ °C	13		500		500		500	nA
Drain-Source On-Voltage	$V_{DS(on)}$	$V_{GS} = 0 V$	$I_D = 5 mA$	0.25					0.5		V
			$I_D = 10 mA$	0.35			0.5				
			$I_D = 20 mA$	0.5		0.75					
Drain-Source On-Resistance ^c	$r_{DS(on)}$	$V_{GS} = 0 V, I_D = 1 mA$			25		40		60	Ω	
Gate-Source Forward Voltage ^c	$V_{GS(F)}$	$I_G = 1 mA, V_{DS} = 0 V$	0.7							V	
Dynamic											
Common-Source Forward Transconductance ^c	g_{fs}	$V_{DS} = 20 V, I_D = 1 mA$ $f = 1 kHz$	6							mS	
	g_{os}		25							μS	
Drain-Source On-Resistance	$r_{ds(on)}$	$V_{GS} = 0 V, I_D = 0 mA$ $f = 1 kHz$			25		40		60	Ω	
Common-Source Input Capacitance	C_{iss}	$V_{DS} = 0 V, V_{GS} = -10 V$ $f = 1 MHz$	7		10		10		10	pF	
Common-Source Reverse Transfer Capacitance	C_{rss}		3		4		3.5		3.5		
Equivalent Input Noise Voltage ^c	\bar{e}_n	$V_{DS} = 10 V, I_D = 10 mA$ $f = 1 kHz$	3							nV/ \sqrt{Hz}	
Switching											
Turn-On Time	$t_{d(on)}$	$V_{DD} = 10 V, V_{GSH} = 0 V$ See Switching Circuit	2		5		6		8	ns	
	t_r		2		3		4		8		
Turn-Off Time	t_{OFF}		12		20		40		80		

Notes

- a. Typical values are for DESIGN AID ONLY, not guaranteed nor subject to production testing.
- b. Pulse test: $PW \leq 100 \mu s$ duty cycle $\leq 10\%$.
- c. This parameter not registered with JEDEC.

NCB



TYPICAL CHARACTERISTICS (T_A = 25°C UNLESS OTHERWISE NOTED)

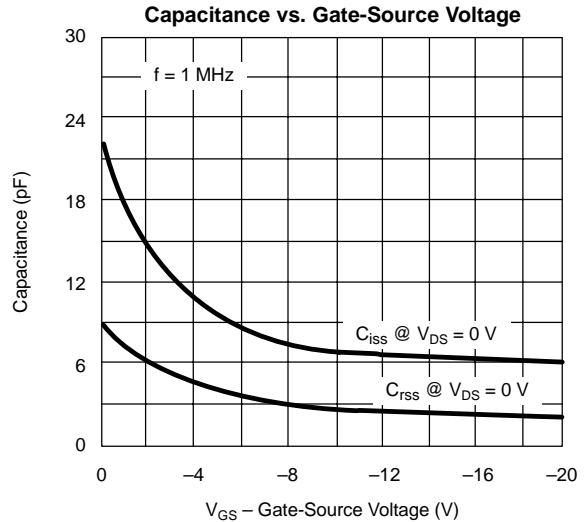
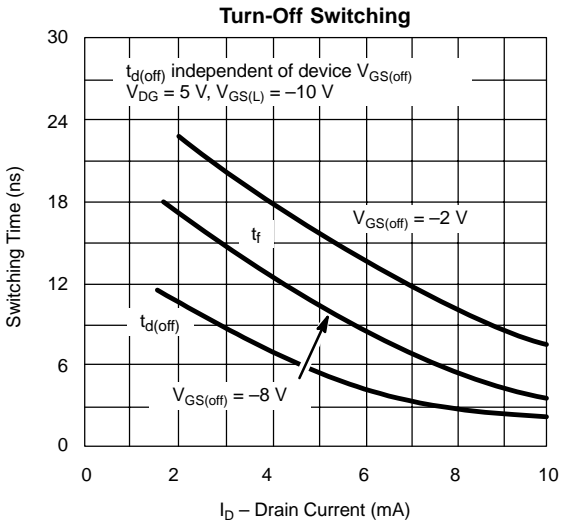
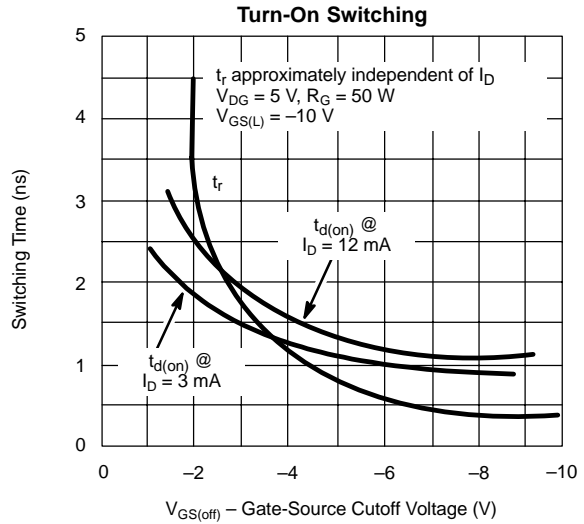
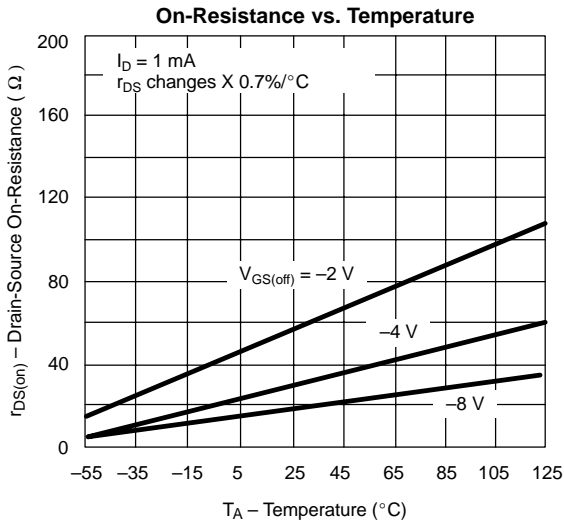
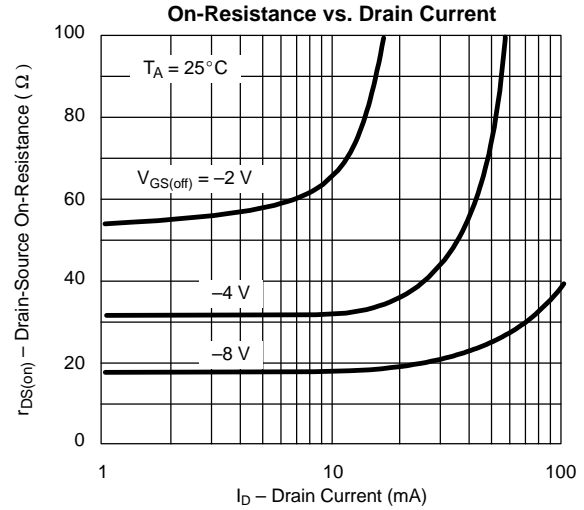
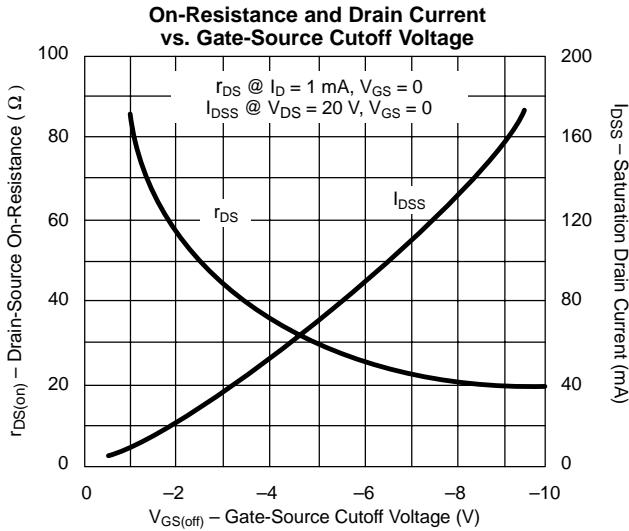

TYPICAL CHARACTERISTICS (T_A = 25°C UNLESS OTHERWISE NOTED)

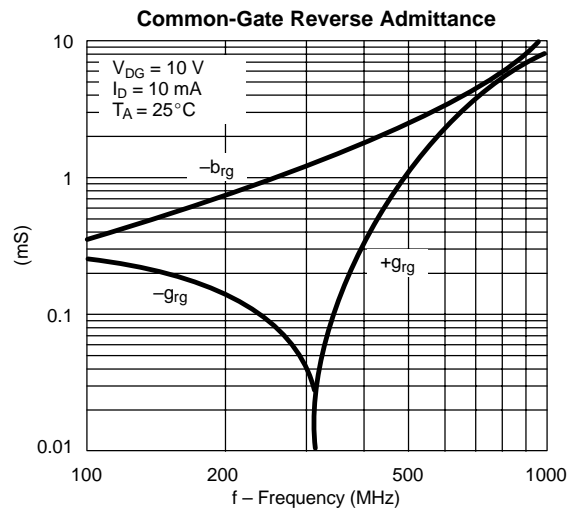
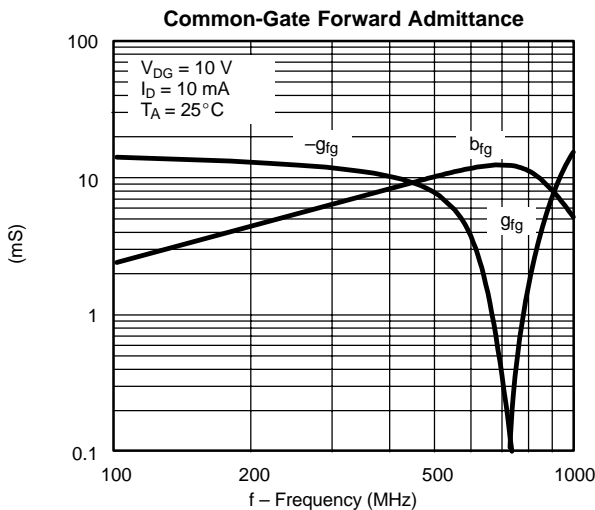
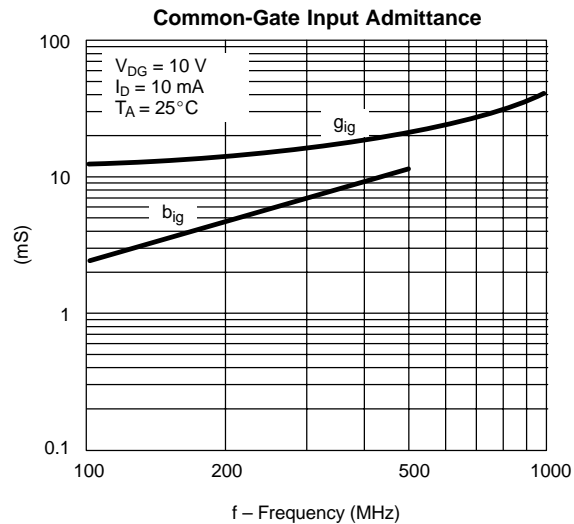
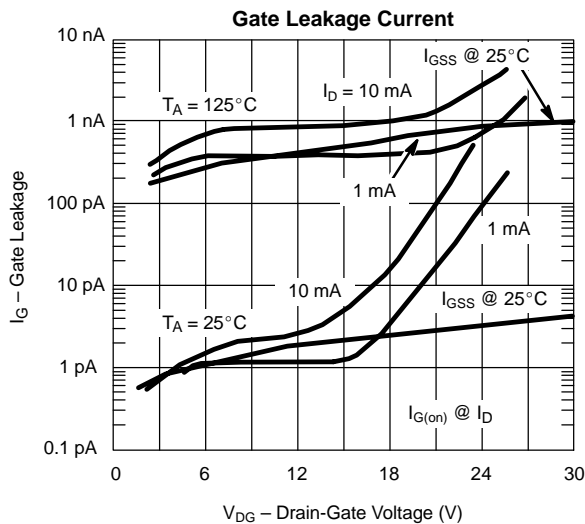
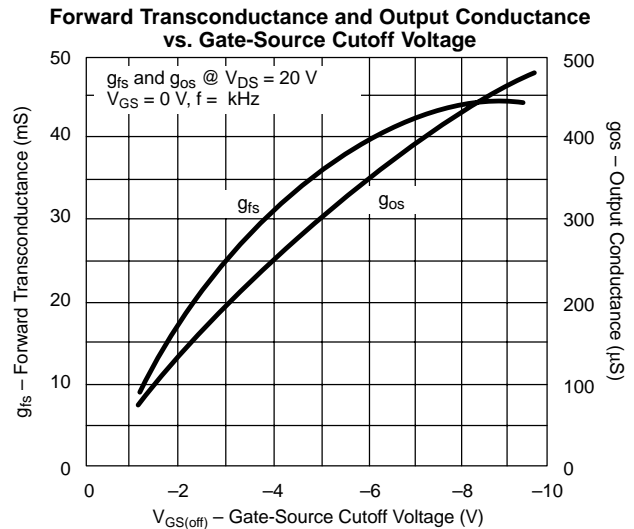
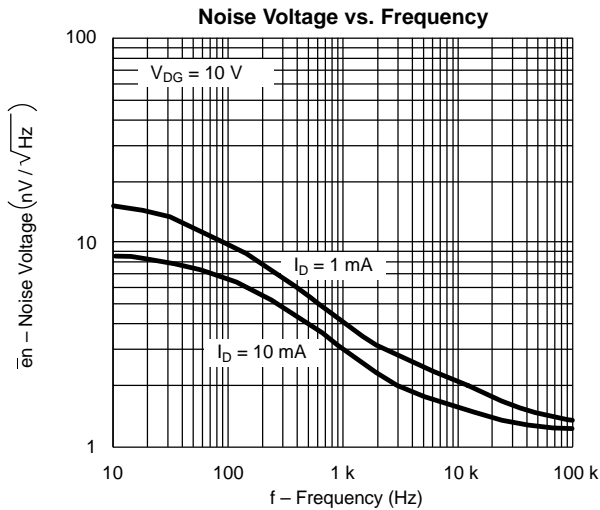



TYPICAL CHARACTERISTICS (T_A = 25°C UNLESS OTHERWISE NOTED)

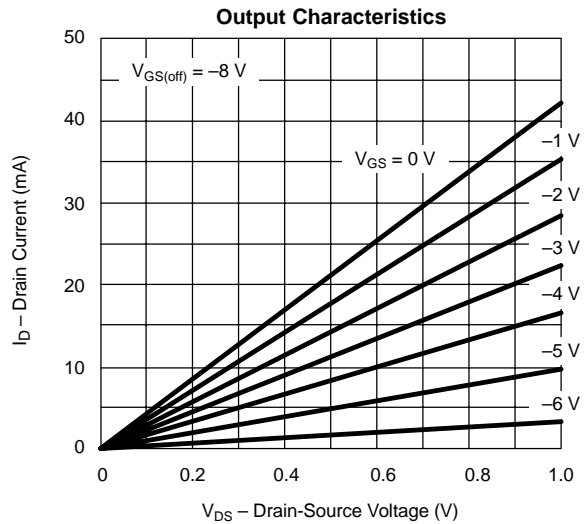
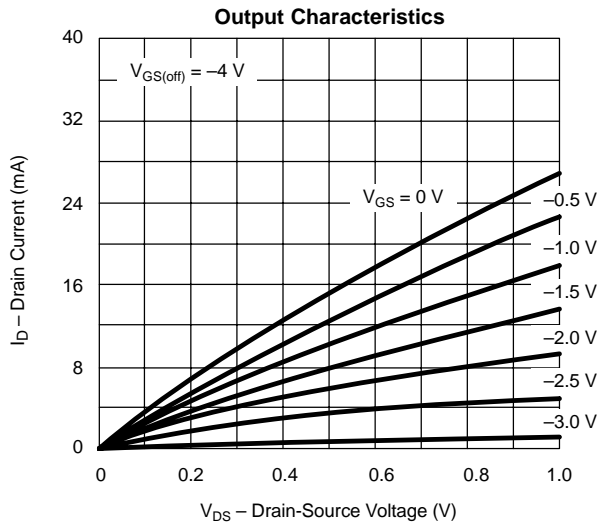
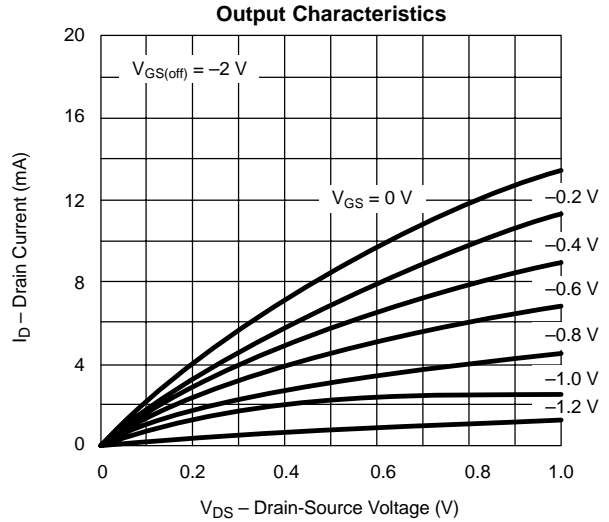
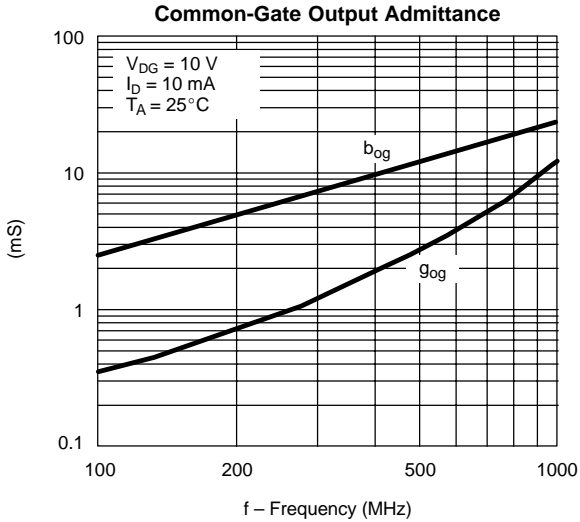

SWITCHING TIME TEST CIRCUIT			
	2N4856A	2N4857A	2N4858A
$V_{GS(L)}$	-10 V	-6 V	-4 V
R_L^*	464 Ω	953 Ω	1910 Ω
$I_{D(on)}$	20 mA	10 mA	5 mA

*Non-inductive

INPUT PULSE

Rise Time < 1 ns
 Fall Time < 1 ns
 Pulse Width 100 ns
 PRF 1 MHz

SAMPLING SCOPE

Rise Time 0.4 ns
 Input Resistance 10 M Ω
 Input Capacitance 1.5 pF

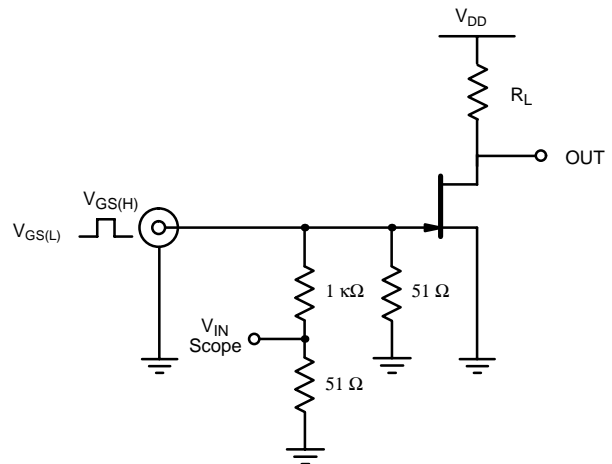

Find price and stock options from leading distributors for 2N4856A on Findchips.com:

<https://findchips.com/search/2N4856A>

Find CAD models and details for this part:

<https://findchips.com/detail/2n4856a/Vishay-Intertechnologies>