

64K (8K x 8) UV ERASABLE PROM

- **FAST ACCESS TIME:**
 200ns MAX M2764A-2F1/M2764A-20F1
 250ns MAX M2764AF1/M2764AF6/M2764A-25F1
 300ns MAX M2764A-3F1/M2764A-30F1
 450ns MAX M2764A-4F1/M2764A-4F6/M2764A-45F1
- 0 to 70°C STANDARD TEMPERATURE RANGE
- -40 to +85°C EXTENDED TEMPERATURE RANGE
- SINGLE +5V POWER SUPPLY
- LOW STANDBY CURRENT (35mA MAX)
- TTL COMPATIBLE
- FAST PROGRAMMING ALGORITHM
- ELECTRONIC SIGNATURE
- ±10% V_{CC} TOLLERANCE AVAILABLE

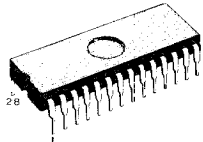

F
Ceramic Package

ORDERING NUMBERS: M2764A-2F1
 M2764AF1
 M2764A-3F1
 M2764A-4F1
 M2764A-20F1
 M2764A-25F1
 M2764A-30F1
 M2764A-45F1
 M2764AF6
 M2764A-4F6

DESCRIPTION

The M2764A is a 65,536-bit ultraviolet erasable and electrically programmable read only memory (EPROM). It is organized as 8,192 words by 8 bits and manufactured using SGS' NMOS-E3 process.

The M2764A with its single +5V power supply and with an access time of 200ns, is ideal for use with high performance +5V microprocessor such as Z8[®], Z80[®] and Z8000[™]. The M2764A has an important feature which is to separate the output control, Output Enable (\overline{OE}) from the Chip Enable control (\overline{CE}). The \overline{OE} control eliminates bus contention in multiple bus microprocessor systems.

The M2764A also features a standby mode which reduces the power dissipation without increasing access time. The active current is 75mA while the maximum standby current is only 35 mA, a 53% saving. The standby mode is achieved by applying a TTL-high signal to the \overline{CE} input. The M2764A has an "Electronic Signature" that allows programmers to automatically identify device type and pinout. The M2764A is available in a 28-lead dual in-line ceramic package (frit-seal) glass lens.

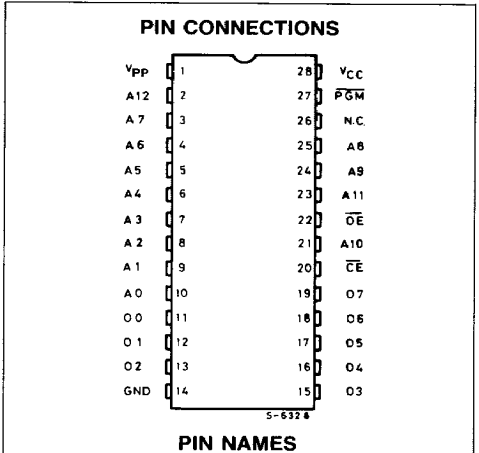

A0-A12	ADDRESS INPUT
\overline{CE}	CHIP ENABLE INPUT
\overline{OE}	OUTPUT ENABLE INPUT
PGM	PROGRAM
N.C.	NO CONNECTION
O0-O7	DATA INPUT/OUTPUT

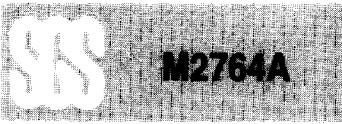

BLOCK DIAGRAM

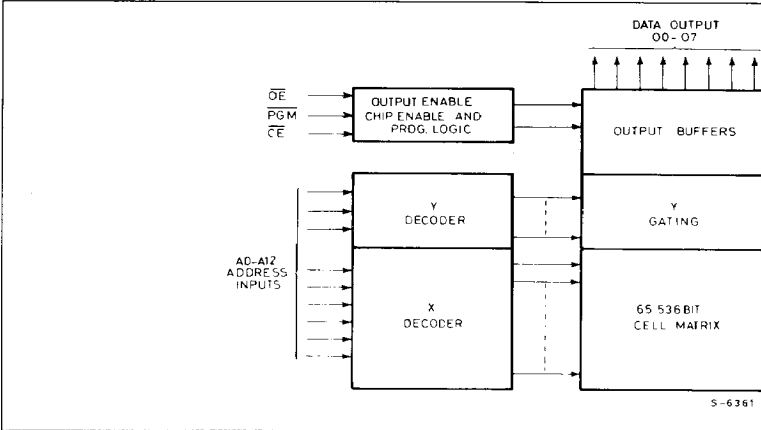

ABSOLUTE MAXIMUM RATINGS

Symbol	Parameter	Values	Unit
V_i	All Input or Output voltages with respect to ground	+ 6.5 to - 0.6	V
V_{PP}	Supply voltage with respect to ground	+ 14 to - 0.6	V
T_{amb}	Ambient temperature under bias /F1 /F6	- 10 to + 80 - 50 to + 95	°C
T_{stg}	Storage temperature range	- 65 to + 125	°C
	Voltage on pin 24 with respect to ground	+ 13.5 to - 0.6	V

Stresses above those listed under "Absolute Maximum Ratings" may cause permanent damage to the device. This is a stress rating of and functional operation of the device at these or any other conditions above those indicated in the operational sections of this specification is not implied. Exposure to absolute maximum rating conditions for extended periods may affect device reliability.

OPERATING MODES

MODE	PINS							
		\overline{CE} (20)	\overline{OE} (22)	A9 (24)	PGM (27)	V_{PP} (1)	V_{CC} (28)	OUTPUT (11-13, 15-19)
READ		V_{IL}	V_{IL}	X	V_{IH}	V_{CC}	V_{CC}	D_{OUT}
OUTPUT DISABLE		V_{IL}	V_{IH}	X	V_{IH}	V_{CC}	V_{CC}	HIGH Z
STANDBY		V_{IH}	X	X	X	V_{CC}	V_{CC}	HIGH Z
FAST PROGRAMMING		V_{IL}	V_{IH}	X	V_{IL}	V_{PP}	V_{CC}	D_{IN}
VERIFY		V_{IL}	V_{IL}	X	V_{IH}	V_{PP}	V_{CC}	D_{OUT}
PROGRAM INHIBIT		V_{IH}	X	X	X	V_{PP}	V_{CC}	HIGH Z
ELECTRONIC SIGNATURE		V_{IL}	V_{IL}	V_H	V_{IH}	V_{CC}	V_{CC}	CODES

NOTE: X can be V_{IH} or V_{IL} $V_H = 12V \pm 0.5V$



READ OPERATION DC AND AC CONDITIONS

	F1 – 2F1 – 3F1/ – 4F1	– 20F1/ – 25F1 – 30F1/ – 45F1	F6/ – 4F6
Operating Temperature Range	0 to 70°C	0 to 70°C	– 40 to 85°C
V _{CC} Power Supply (1,2)	5V ±5%	5V ±10%	5V ±5%
V _{PP} Voltage (2)	V _{PP} = V _{CC}	V _{PP} = V _{CC}	V _{PP} = V _{CC}

DC AND OPERATING CHARACTERISTICS

Symbol	Parameter	Test Conditions	Values			Unit
			Min.	Typ.	Max.	
I _{LI}	Input Load Current	V _{IN} = 5.5V			10	μA
I _{LO}	Output Leakage Current	V _{OUT} = 5.5V			10	μA
I _{PP1(2)}	V _{PP} Current Read	V _{PP} = 5.5V			5	mA
I _{CC1(2)}	V _{CC} Current Standby	$\overline{CE} = V_{IH}$			20/35 ⁽⁶⁾	mA
I _{CC2(2)}	V _{CC} Current Active	$\overline{CE} = \overline{OE} = V_{IL}$			60/75 ⁽⁶⁾	mA
V _{IL}	Input Low Voltage		– 0.1		+ 0.8	V
V _{IH}	Input High Voltage		2.0		V _{CC} + 1	V
V _{OL}	Output Low Voltage	I _{OL} = 2.1 mA			0.45	V
V _{OH}	Output High Voltage	I _{OH} = – 400 μA	2.4			V
V _{PP1(2)}	V _{PP} Read Voltage	V _{CC} = 5V ± 0.25V	3.8		V _{CC}	V

AC CHARACTERISTICS

Symbol	Parameter	Test Conditions	2764A-2 2764A-20		2764A-25 / 2764A		2764A-30 / 2764A-3		2764A-45 / 2764A-4		Unit
			Min	Max	Min	Max	Min	Max	Min	Max	
t _{ACC}	Address to Output Delay	$\overline{CE} = \overline{OE} = V_{IL}$		200		250		300		450	ns
t _{CE}	\overline{CE} to Output Delay	$\overline{OE} = V_{IL}$		200		250		300		450	ns
t _{OE}	\overline{OE} to Output Delay	$\overline{CE} = V_{IL}$		75		100		120		150	ns
t _{DF(4)}	\overline{OE} High to Output Float	$\overline{CE} = V_{IL}$	0	55	0	60	0	105	0	130	ns
t _{OH}	Output Hold from Address CE or OE Whichever Occurred First	$\overline{CE} = \overline{OE} = V_{IL}$	0		0		0		0		ns

CAPACITANCE⁽⁵⁾ (T_{amb} = 25°C, f = 1 MHz)

Symbol	Parameter	Test Conditions	Min.	Typ.	Max.	Unit
C _{IN}	Input Capacitance	V _{IN} = 0V		4	6	pF
C _{OUT}	Output Capacitance	V _{OUT} = 0V		8	12	pF

- Notes:
- V_{CC} must be applied simultaneously or before V_{PP} and removed simultaneously or after V_{PP}.
 - V_{PP} may be connected directly to V_{CC} except during programming.
The supply current would then be the sum of I_{CC} and I_{PP1}.
 - Typical values are for T_{amb} = 25°C and nominal supply voltages.
 - This parameter is only sampled and not 100% tested. Output Float is defined as the point where data is no longer driven-see timing diagram.
 - This parameter is only sampled and is not 100% tested.
 - Max: I_{CC} rating differs with access time. Rating of 60mA active and 20mA standby are for M2764A at 200 ns access time only.



AC TEST CONDITIONS

Output Load: 100pF + 1TTL Gate
 Input Rise and Fall Times: $\leq 20\text{ns}$
 Input Pulse Levels: 0.45 to 2.4V

Timing Measurement Reference Levels: Inputs 0.8 and 2V
 Outputs 0.8 and 2V

AC TESTING INPUT/OUTPUT WAVEFORM

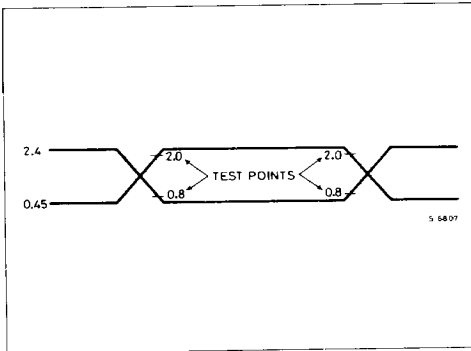

AC TESTING LOAD CIRCUIT

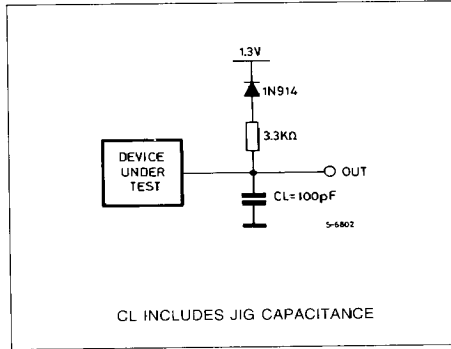

AC WAVEFORMS

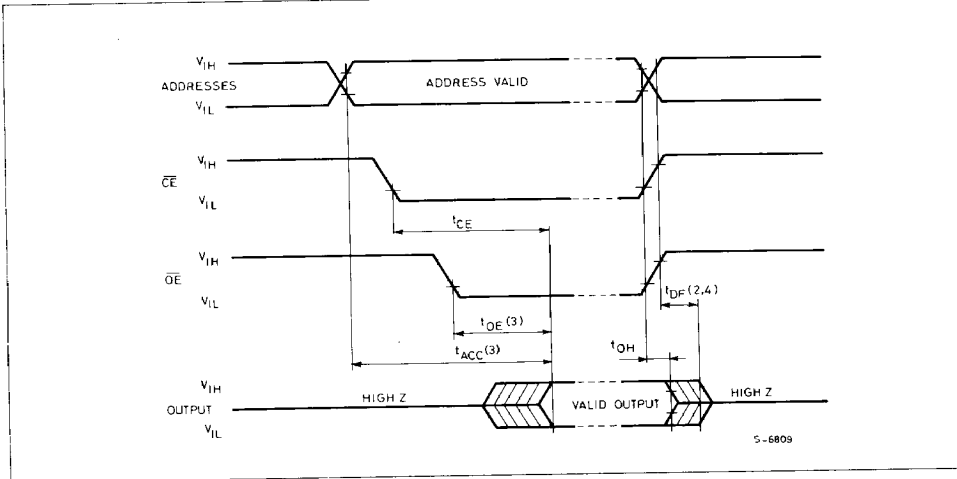

Notes:

- 1 Typical values are for $T_{amb} = 25^{\circ}\text{C}$ and nominal supply voltage.
- 2 This parameter is only sampled and not 100% tested.
- 3 \overline{OE} may be delayed up to $t_{ACC} - t_{OE}$ after the falling edge \overline{CE} without impact on t_{ACC} .
- 4 t_{DF} is specified from \overline{OE} or \overline{CE} whichever occurs first.



DEVICE OPERATION

The seven modes of operations of the M2764A are listed in the Operating Modes. A single 5V power supply is required in the read mode. All inputs are TTL levels except for V_{PP} and 12V on A9 for Electronic Signature.

READ MODE

The M2764A has two control function, both of which must be logically satisfied in order to obtain data at the outputs. Chip Enable (\overline{CE}) is the power control and should be used for device selection. Output Enable (\overline{OE}) is the output control and should be used to gate data to the output pins, independent of device selection. Assuming that addresses are stable, address access time (t_{ACC}) is equal to delay from \overline{CE} to output (t_{CE}). Data is available at the outputs after the falling edge of \overline{OE} , assuming that \overline{CE} has been low and addresses have been stable for at least $t_{ACC-1OE}$.

STANDBY MODE

The M2764A has a standby mode which reduces the maximum active power current from 75 mA to 35 mA. The M2764A is placed in the standby mode by applying a TTL high signal to the \overline{CE} input. When in the standby mode, the outputs are in a high impedance state, independent of the \overline{OE} input.

OUTPUT OR-TIEING

Because EPROMs are usually used in larger memory arrays, the product features a 2 line control function which accommodates the use of multiple memory connection. The two line control function allows:

- a) the lowest possible memory power dissipation
- b) complete assurance that output bus contention will not occur.

For the most efficient use of these two control lines, \overline{CE} should be decoded and used as the primary device selecting function, while \overline{OE} should be made a common connection to all devices in the array and connected to the \overline{READ} line from the system control bus. This assures that all deselected memory devices are in their low power standby mode and that the output pins are only active when data is desired from a particular memory device.

SYSTEM CONSIDERATIONS

The power switching characteristics of NMOS-E3 EPROMs require careful decoupling of the devices the supply current, I_{CC} , has three segments that are of interest to the system designer: the standby current level, the active current level, and transient current peaks that are produced by the falling and rising edges of \overline{CE} . The magnitude of this transient current peaks is dependent on the output capacitive and inductive loading of the device. The associated transient voltage peaks can be suppressed by complying with the two line output control and by properly selected decoupling capacitors. It is recommended that a $1\ \mu\text{F}$ ceramic capacitor be used on every device between V_{CC} and GND. This should be a high frequency capacitor of low inherent inductance and should be placed as close to the device as possible. In addition, a $4.7\ \mu\text{F}$ bulk electrolytic capacitors should be used between V_{CC} and GND for every eight devices. The bulk capacitor should be located near where the power supply is connected to the array. The purpose of the bulk capacitor is to overcome the voltage drop caused by the inductive effects of PCB traces.

PROGRAMMING

Caution: exceeding 14V on pin 1 (V_{PP}) will damage the M2764A.

When delivered, and after each erasure, all bits of the M2764A are in the "1" state. Data is introduced by selectively programming "0s" into the desired bit locations. Although only "0s" will be programmed, both "1s" and "0s" can be present in the data word. The only way to change a "0" to a "1" is by ultraviolet light erasure. The M2764A is in the programming mode when V_{PP} input is at 12.5V and \overline{CE} and PGM are at TTL low. The data to be programmed is applied 8 bits in parallel to the data output pins. The levels required for the address and data inputs are TTL.

FAST PROGRAMMING ALGORITHM

Fast Programming Algorithm rapidly programs M2764A EPROMs using an efficient and reliable method suited to the production programming environment. Programming reliability is also ensured as the incremental program margin of each byte is continually monitored to determine when it has been successfully programmed. A flowchart of the

M2764A

M2764A Fast Programming Algorithm is shown on the last page. The Fast Programming Algorithm utilizes two different pulse types: initial and over-program.

The duration of the initial $\overline{\text{PGM}}$ pulse (s) is one millisecond, which will then be followed by a longer over-program pulse of length $3X\text{msec}$. (X is an iteration counter and is equal to the number of the initial one millisecond pulses applied to a particular M2764A location), before a correct verify occurs. Up to 25 one-millisecond pulses per byte are provided for before the over program pulse is applied. The entire sequence of program pulses and byte verifications is performed at $V_{CC} = 6\text{V}$ and $V_{PP} = 12.5\text{V}$. When the Fast Programming cycle has been completed, all bytes should be compared to the original data with $V_{CC} = V_{PP} = 5\text{V}$.

PROGRAM INHIBIT

Programming of multiple M2764As in parallel with different data is also easily accomplished. Except for $\overline{\text{CE}}$, all like inputs (including $\overline{\text{OE}}$) of the parallel M2764A may be common. A TTL low pulse applied to a M2764A's $\overline{\text{CE}}$ input, with V_{PP} at 12.5V, will program that M2764A. A high level $\overline{\text{CE}}$ input inhibits the other M2764A from being programmed.

PROGRAM VERIFY

A verify should be performed on the programmed bits to determine that they were correctly programmed. The verify is accomplished with $\overline{\text{OE}}$ at V_{IL} , $\overline{\text{CE}}$ at V_{IL} , $\overline{\text{PGM}}$ at V_{IH} and V_{PP} at 12.5V.

ELECTRONIC SIGNATURE

The Electronic Signature mode allows the reading out of a binary code from an EPROM that will identify its manufacturer and type. This mode is intended for use by programming equipment for the purpose of automatically matching the device to be programmed with its corresponding programming

algorithm. This mode is functional in the $25^\circ \pm 5^\circ\text{C}$ ambient temperature range that is required when programming the M2764A. To activate this mode, the programming equipment must force 11.5V to 12.5V on address line A9 (pin 24) of the M2764A. Two identifier bytes may then be sequenced from the device outputs by toggling address line A0 (pin 10) from V_{IL} to V_{IH} . All other address lines must be held at V_{IL} during Electronic Signature mode. Byte 0 ($A0 = V_{IL}$) represents the manufacturer code and byte 1 ($A0 = V_{IH}$) the device identifier code. For the SGS M2764A, these two identifier bytes are given below. All identifiers for manufacturer and device codes will possess odd parity, with the MSB (07) defined as the parity bit.

ERASURE OPERATION

The erasure characteristic of the M2764A is such that erasure begins when the cells are exposed to light with wavelengths shorter than approximately 4000 Angstrom \AA . It should be noted that sunlight and some type of fluorescent lamps have wavelengths in the 3000-4000 \AA range. Data show that constant exposure to room level fluorescent lighting could erase a typical M2764A in about a year, while it would take approximately 1 week to cause erasure when exposed to direct sunlight. The M2764A is to be exposed to these type lighting conditions for extended periods of time, it is suggested that opaque labels to put over the M2764A window to prevent unintentional erasure. The recommended erasure procedure for the M2764A is exposure to short wave ultraviolet light which has wavelength 2537 \AA . The integrated dosage (i.e. UV intensity x exposure time) for erasure should be a minimum of 15 W-sec/cm². The erasure time with this dosage is approximately 10 to 20 minutes using an ultraviolet lamp with 1200 $\mu\text{W/cm}^2$ power rating. The M2764A should be placed within 2.5 cm (1 inch) of the lamp tubes during the erasure. Some lamps have a filter on the tubes which should be removed before erasure.

ELECTRONIC SIGNATURE MODE

IDENTIFIER	PINS										Hex Data
	A0 (10)	O7 (19)	O6 (18)	O5 (17)	O4 (16)	O3 (15)	O2 (13)	O1 (12)	O0 (11)		
Manufacturer code	V_{IL}	0	0	1	0	0	0	0	0	0	20
Device code	V_{IH}	0	0	0	0	1	0	0	0	0	08

PROGRAMMING OPERATION ($T_{amb} = 25^{\circ}\text{C} \pm 5^{\circ}\text{C}$, $V_{CC}^{(1)} = 6\text{V} \pm 0.25\text{V}$, $V_{PP}^{(1)} = 12.5\text{V} \pm 0.3\text{V}$)

DC AND OPERATING CHARACTERISTIC

Symbol	Parameter	Test Conditions	Values			Unit
			Min.	Typ.	Max.	
I_{LI}	Input Current (All Inputs)	$V_{IN} = V_{IL}$ or V_{IH}			10	μA
V_{IL}	Input Low Level (All Inputs)		-0.1		0.8	V
V_{IH}	Input High Level		2.0		V_{CC}	V
V_{OL}	Output Low Voltage During Verify	$I_{OL} = 2.1\text{ mA}$			0.45	V
V_{OH}	Output High Voltage During Verify	$I_{OH} = -400\ \mu\text{A}$	2.4			V
I_{CC2}	V_{CC} Supply Current (Program & Verify)				75	mA
I_{PP2}	V_{PP} Supply Current (Program)	$\overline{CE} = V_{IL}$			50	mA
V_{ID}	A9 Electronic Signature Voltage		11.5		12.5	V

AC CHARACTERISTICS

Symbol	Parameter	Test Conditions	Values			Unit
			Min.	Typ.	Max.	
t_{AS}	Address Setup Time		2			μs
t_{OES}	\overline{OE} Setup Time		2			μs
t_{DS}	Data Setup Time		2			μs
t_{AH}	Address Hold Time		0			μs
t_{DH}	Data Hold Time		2			μs
$t_{DFP(4)}$	Output Enable Output Float Delay		0		130	ns
t_{VPS}	V_{PP} Setup Time		2			μs
t_{VCS}	V_{CC} Setup Time		2			μs
t_{PW}	PGM Initial Program Pulse Width	(see Note 3)	0.95	1.0	1.05	ms
t_{OPW}	PGM Overprogram Pulse Width	(see Note 2)	2.85		78.75	ms
t_{OE}	Data Valid from \overline{OE}				150	ns

Notes:

- V_{CC} must be applied simultaneously or before V_{PP} and removed simultaneously or after V_{PP} .
 - The length of the overprogram pulse may vary from 2.85msec to 78.75msec as a function of the iteration counter value X.
 - Initial Program Pulse width tolerance is 1msec $\pm 5\%$.
 - This parameter is only sampled and not 100% tested.
- Output Float is defined as the point where data is no longer driven (see timing diagram).



PROGRAMMING WAVEFORMS

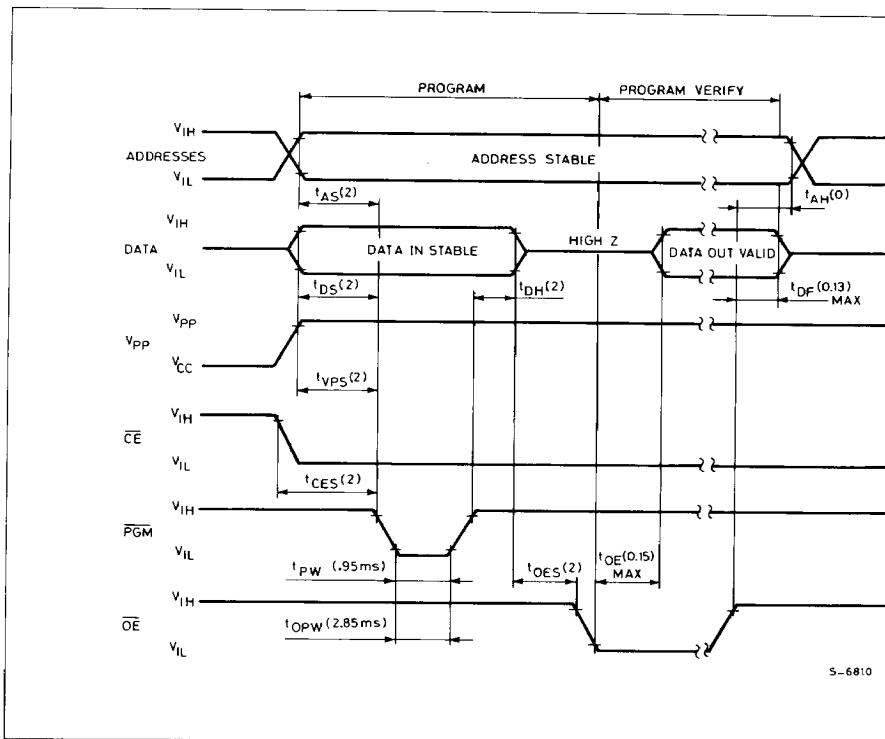

5-6810

Notes:

1. All times shown in () are minimum and in usec unless otherwise specified.
2. The input timing reference level is 0.8V for a V_{IL} and 2V for a V_{IH} .
3. t_{OE} and t_{OPW} are characteristics of the device but must be accommodated by the programmer.
4. When programming the M2764A a 0.1 μ F capacitor is required across V_{PP} and GROUND to suppress spurious voltage transients which can damage the device.

FAST PROGRAMMING FLOWCHART

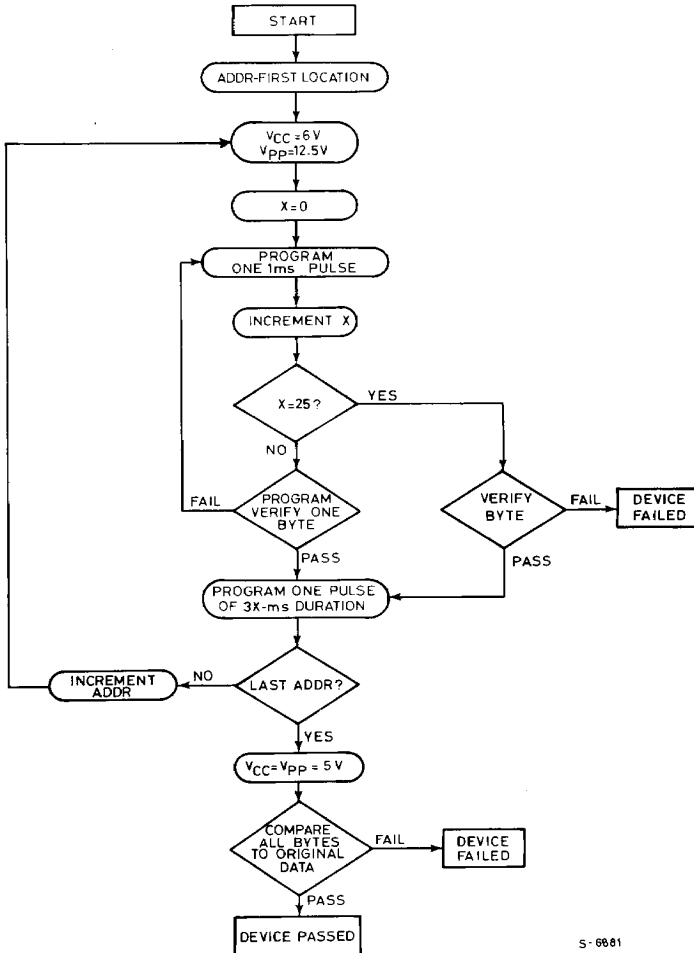

5-0001