

Contents

Features	1
Applications	1
Options	1
Pin Assignment	1
Pin Functions	1
Block Diagram	2
Selection Guide	3
Absolute Maximim Ratings.....	4
Electrical Characteristics	4
Test Circuits.....	8
Technical Terms	8
Operation Timing Charts.....	9
Operation	10
Dimensions	12
Markings	12
Taping	13
Transient Response	14
Standard Curcuit.....	21
Application Curcuits.....	21
Notes.....	22
Characteristics	23

The S-87X Series are low-power high withstand-voltage voltage regulators with reset function, which integrate high-precision voltage detection and voltage regulation circuits on one chip. The S-87X Series have a higher withstand-voltage characteristic and a higher accuracy of detection voltage and output voltage, which is $\pm 2.4\%$, than our S-870 Series voltage regulators.

■ **Features**

- Accuracy of output voltage: $\pm 2.4\%$ (3.0 V / 5.0 V)
- Accuracy of detection voltage: $\pm 2.4\%$
- Low I/O voltage difference:
 - 0.15 V typ. at $I_{OUT} = 30$ mA, 5.0 V
 - 0.45 V typ. at $I_{OUT} = 30$ mA, 3.0 V
- Low current consumption: 8 μ A typ.
- Wide operating voltage range: 24.0 V max.
- Wide operating temperature range: -40°C to +85°C
- Built-in delay circuit and short-circuit protection circuit
- Small package: SOT-89-5

■ **Applications**

- Constant voltage power supply or reset circuit of battery-powered equipment, VTR, camera, communications equipment, or others.

■ **Pin Assignment**

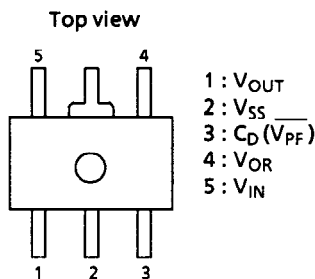

Figure 1 Pin assignment

■ **Pin Functions**

Table 1

Pin No.	Name	Functions
1	V_{OUT}	Voltage output pin of voltage regulator
2	V_{SS}	Ground
3	C_D	Connection pin of external capacitor for delay of voltage detector
	$\overline{V_{PF}}$	Input pin of shutdown circuit
4	V_{OR}	Output pin of voltage detector (Nch opendrain output)
5	V_{IN}	Positive power-supply input pin

HIGH-WITHSTAND-VOLTAGE VOLTAGE REGULATOR WITH RESET FUNCTION

S-87X Series

■ Block Diagram

- 1) Built-in delay circuit, V_{IN} detection
(S-87XXXXA Series)

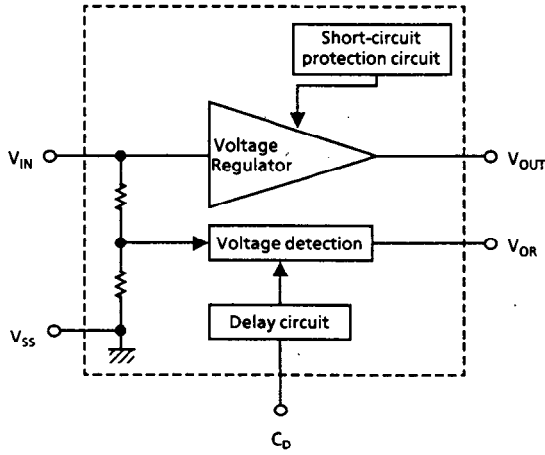

- 2) Built-in delay circuit, V_{OUT} detection
(S-87XXXXB Series)

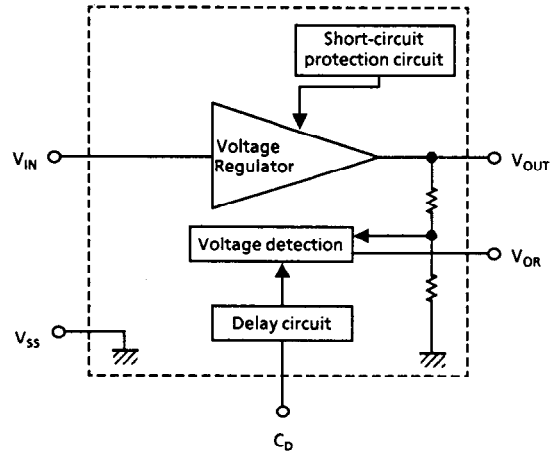

- 3) Built-in shutdown circuit (regulators only), V_{IN} detection
(S-87XXXXC Series)

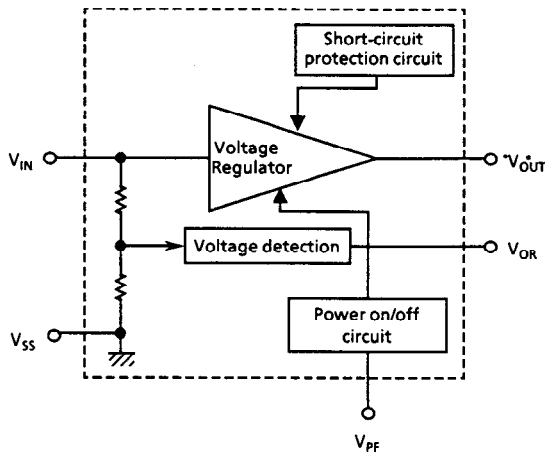

Figure 2 Block diagram

■ Selection Guide

1. Series selection

Table 2

Series name	Voltage detector (VD)	Built-in Delay circuit	Shutdown function	
			VR	VD
S-87XXXXA	Detects V_{IN}	Yes	No	No
S-87XXXXB	Detects V_{OUT}	Yes	No	No
S-87XXXXC	Detects V_{IN}	No	Yes	No

2. Product name

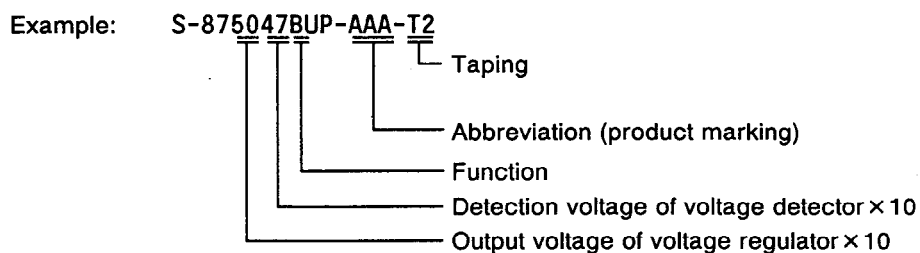

3. Product List

VR output voltage	VD detection voltage	S-87XXXXA Series	S-87XXXXB Series	S-87XXXXC Series
5.0V	4.5V	S-875045AUP-AAA-T2	S-875045BUP-ABA-T2	S-875045CUP-ACA-T2
5.0V	4.3V	S-875043AUP-AAB-T2	S-875043BUP-ABB-T2	S-875043CUP-ACB-T2
5.0V	4.1V	S-875041AUP-AAC-T2	S-875041BUP-ABC-T2	S-875041CUP-ACC-T2
5.0V	3.9V	S-875039AUP-AAD-T2	S-875039BUP-ABD-T2	S-875039CUP-ACD-T2
5.0V	3.7V	S-875037AUP-AAE-T2	S-875037BUP-ABE-T2	S-875037CUP-ACE-T2
3.0V	2.5V	S-873025AUP-ADA-T2	S-873025BUP-AEA-T2	S-873025CUP-AFA-T2
3.0V	2.4V	S-873024AUP-ADB-T2	S-873024BUP-AEB-T2	S-873024CUP-AFB-T2
3.0V	2.3V	S-873023AUP-ADC-T2	S-873023BUP-AEC-T2	S-873023CUP-AFC-T2
3.0V	2.2V	S-873022AUP-ADD-T2	S-873022BUP-AED-T2	S-873022CUP-AFD-T2
3.0V	2.1V	S-873021AUP-ADE-T2	S-873021BUP-AEE-T2	S-873021CUP-AFE-T2

Note In the S-87XXXXB Series, if the output voltage of the voltage regulator is close to the detection voltage of the voltage detector, the transient response of the voltage regulator may be detection of an error. When selecting the voltage, take into account "Transient Response".

HIGH-WITHSTAND-VOLTAGE VOLTAGE REGULATOR WITH RESET FUNCTION

S-87X Series

Absolute Maximum Ratings

Table 3

Parameter	Symbol	Ratings	Unit
Input voltage	V_{IN}, V_{PF}	26	V
Output voltage	V_{OUT}	$V_{IN} + 0.3$ to $V_{SS} - 0.3$	V
Output voltage of voltage detector	V_{OR}	$V_{SS} - 0.3$ to 26	V
Power dissipation	P_D	500	mW
Operating temperature	T_{opr}	-40 to +85	°C
Storage temperature	T_{stg}	-40 to +125	°C

Electrical Characteristics

1. S-8750XXA/B Series

Table 4

(Unless otherwise specified: $T_a = 25^\circ\text{C}$)

Parameter	Symbol	Conditions	Standard			Unit	Test cir.		
			Min.	Typ.	Max.				
V o l t a g e r e g u l a t o r	Output voltage	V_{OUT}	$V_{IN} = 7\text{ V}, I_{OUT} = 30\text{ mA}$	4.88	5.00	5.12	V	1	
	I/O voltage difference	V_{dif}	$I_{OUT} = 30\text{ mA}$	—	0.15	0.40	V	1	
	Line regulation	ΔV_{OUT1}	$V_{IN} = 6$ to 24 V $I_{OUT} = 30\text{ mA}$	—	15	50	mV	1	
	Load regulation	ΔV_{OUT2}	$V_{IN} = 7\text{ V}$ $I_{OUT} = 50\ \mu\text{A}$ to 40 mA	—	15	50	mV	1	
	Input voltage	V_{IN}		—	—	24	V	1	
	Temp. coefficient of V_{OUT}	$\frac{\Delta V_{OUT}}{\Delta T_a}$	$V_{IN} = 7\text{ V}, I_{OUT} = 30\text{ mA},$ $T_a = -40^\circ\text{C}$ to $+85^\circ\text{C}$	—	± 0.38	± 1.52	mV/°C	1	
V o l t a g e d e t e c t o r	Operating voltage	V_{SEN}		1.3	—	24	V	2	
	Delay time*1	t_{pd}	$C_D = 4.7\text{ nF}$	15	27	41	ms	3	
	Temp. characteristic of $-V_{DET}$	$\frac{\Delta -V_{DET}}{\Delta T_a}$	$T_a = -40^\circ\text{C}$ to $+85^\circ\text{C}$	—	± 0.5	± 2.0	mV/°C	2	
	Detection voltage	$-V_{DET}$	S-875045A/B	4.392	4.50	4.608	V	2	
			S-875043A/B	4.196	4.30	4.404	V	2	
			S-875041A/B	4.001	4.10	4.199	V	2	
			S-875039A/B	3.806	3.90	3.994	V	2	
			S-875037A/B	3.611	3.70	3.789	V	2	
	Sink current	I_{DOUT}	Nch $V_{DS} = 0.5\text{ V}$	$V_{IN} = 1.2\text{ V}$	0.25	0.60	—	mA	4
				$V_{IN} = 2.4\text{ V}$	1.50	2.60	—	mA	4
$V_{IN} = 3.6\text{ V}$				3.00	4.50	—	mA	4	
Leakage current	I_{LEAK}	Nch $V_{DS} = 24\text{ V}, V_{IN} = 10\text{ V}$	—	—	0.1	μA	4		
Hysteresis width	V_{HYS}	S-875045A/B	1	—	2.5	%	2		
		S-875043A/B, 41A/B, 39A/B, 37A/B	3	—	8	%	2		
Current consumption*2	I_{SS}	$V_{IN} = 7\text{ V},$ Unloaded	—	3	8	μA	5		

*1 t_{pd} (ms) = (3.18 min., 5.74 typ., 8.73 max.) $\times C_D$ (nF)

*2 Excluding the charging current of C_D

HIGH-WITHSTAND-VOLTAGE VOLTAGE REGULATOR WITH RESET FUNCTION

S-87X Series

2. S-8730XXA/B Series

Table 5

(Unless otherwise specified: Ta = 25°C)

	Parameter	Symbol	Conditions	Standard			Unit	Test cir.	
				Min.	Typ.	Max.			
V R E G U L A T O R	Output voltage	V _{OUT}	V _{IN} = 5 V, I _{OUT} = 30 mA	2.928	3.000	3.072	V	1	
	I/O voltage difference	V _{dif}	I _{OUT} = 30 mA	—	0.45	0.70	V	1	
	Line regulation	ΔV _{OUT1}	V _{IN} = 4 to 24 V I _{OUT} = 30 mA	—	15	50	mV	1	
	Load regulation	ΔV _{OUT2}	V _{IN} = 5 V I _{OUT} = 50 μA to 40 mA	—	15	50	mV	1	
	Input voltage	V _{IN}		—	—	24	V	1	
	Temp. coefficient of V _{OUT}	$\frac{\Delta V_{OUT}}{\Delta T_a}$	V _{IN} = 5 V, I _{OUT} = 30 mA, Ta = -40°C to +85°C	—	± 0.23	± 0.92	mV/°C	1	
V O L T A G E D E T E C T O R	Operating voltage	V _{SEN}		1.3	—	24	V	2	
	Delay time*1	t _{pd}	C _D = 4.7 nF	15	27	41	ms	3	
	Temp. characteristic of -V _{DET}	$\frac{\Delta -V_{DET}}{\Delta T_a}$	Ta = -40°C to +85°C	—	± 0.3	± 1.2	mV/°C	2	
	Detection voltage	-V _{DET}	S-873025A/B	2.440	2.500	2.560	V	2	
			S-873024A/B	2.342	2.400	2.458	V	2	
			S-873023A/B	2.245	2.300	2.356	V	2	
			S-873022A/B	2.147	2.200	2.253	V	2	
			S-873021A/B	2.049	2.100	2.151	V	2	
	Sink current	I _{DOUT}	Nch V _{DS} = 0.5 V	V _{IN} = 1.3 V	0.25	0.60	—	mA	4
				V _{IN} = 2.4 V*3	1.50	2.60	—	mA	4
Leakage current	I _{LEAK}	Nch V _{DS} = 24 V, V _{IN} = 10 V	—	—	0.1	μA	4		
Hysteresis width*2	V _{HYS}		3	—	8	%	2		
Current consumption	I _{SS}	V _{IN} = 5 V, Unloaded	—	3	8	μA	5		

*1 t_{pd} (ms) = (3.18 min., 5.74 typ., 8.73 max.) × C_D (nF)

*2 Excluding the charging current of C_D

*3 S-873025A/B only

HIGH-WITHSTAND-VOLTAGE VOLTAGE REGULATOR WITH RESET FUNCTION

S-87X Series

3. S-8750XXC Series

Table 6

(Unless otherwise specified: Ta = 25°C)

Parameter	Symbol	Conditions	Standard			Unit	Test cir.		
			Min.	Typ.	Max.				
V R e g u l a t o r	Output voltage	V _{OUT}	V _{IN} = 7 V, I _{OUT} = 30 mA	4.88	5.00	5.12	V	1	
	I/O voltage difference	V _{dif}	I _{OUT} = 30 mA	—	0.15	0.40	V	1	
	Line regulation	ΔV _{OUT1}	V _{IN} = 6 to 24 V I _{OUT} = 30 mA	—	15	50	mV	1	
	Load regulation	ΔV _{OUT2}	V _{IN} = 7 V I _{OUT} = 50 μA to 40 mA	—	15	50	mV	1	
	Input voltage	V _{IN}		—	—	24	V	1	
	Temp. coefficient of V _{OUT}	$\frac{\Delta V_{OUT}}{\Delta T_a}$	V _{IN} = 7 V, I _{OUT} = 30 mA, Ta = -40°C to +85°C	—	± 0.38	± 1.52	mV/°C	1	
	Power off output voltage	V _{OUTOFF}	V _{IN} = 7 V, V _{PF} = "L" R _L = 1 MΩ	—	—	0.1	V	6	
V o l t a g e d e t e c t o r	Operating voltage	V _{SEN}		1.3	—	24	V	2	
	Temp. characteristic of -V _{DET}	$\frac{\Delta -V_{DET}}{\Delta T_a}$	Ta = -40°C to +85°C	—	± 0.5	± 2.0	mV/°C	2	
	Detection voltage	-V _{DET}	S-875045C		4.392	4.50	4.608	V	2
			S-875043C		4.196	4.30	4.404	V	2
			S-875041C		4.001	4.10	4.199	V	2
			S-875039C		3.806	3.90	3.994	V	2
			S-875037C		3.611	3.70	3.789	V	2
	Sink current	I _{DOUT}	Nch V _{DS} = 0.5 V	V _{IN} = 1.2 V	0.25	0.60	—	mA	4
				V _{IN} = 2.4 V	1.50	2.60	—	mA	4
				V _{IN} = 3.6 V	3.00	4.50	—	mA	4
Leakage current	I _{LEAK}	Nch V _{DS} = 24 V, V _{IN} = 10 V	—	—	0.1	μA	4		
Hysteresis width	V _{HYS}	S-875045C		1	—	2.5	%	2	
		S-875043C, 41C, 39C, 37C		3	—	8	%	2	
Current consumption	I _{SS}	V _{IN} = 7 V, Unloaded		—	3	8	μA	5	
	I _{of}	V _{PF} = "L": Power off, V _{IN} = 7 V		—	1.5	3.5	μA	5	
Shutdown input voltage	V _{IL}	V _{PF} = "L": Power off, V _{IN} = 7 V		—	—	0.4	V	6	
	V _{IH}	V _{PF} = "H": Power on, V _{IN} = 7 V		2.0	—	—	V	6	

HIGH-WITHSTAND-VOLTAGE VOLTAGE REGULATOR WITH RESET FUNCTION

S-87X Series

4. S-8730XXC Series

Table 7

(Unless otherwise specified: Ta = 25°C)

Parameter	Symbol	Conditions	Standard			Unit	Test cir.	
			Min.	Typ.	Max.			
Voltage regulator	Output voltage	V _{OUT}	V _{IN} = 5 V, I _{OUT} = 30 mA	2.928	3.000	3.072	V	1
	I/O voltage difference	V _{dif}	I _{OUT} = 30 mA	—	0.45	0.70	V	1
	Line regulation	ΔV _{OUT1}	V _{IN} = 4 to 24 V I _{OUT} = 30 mA	—	15	50	mV	1
	Load regulation	ΔV _{OUT2}	V _{IN} = 5 V I _{OUT} = 50 μA to 40 mA	—	15	50	mV	1
	Input voltage	V _{IN}		—	—	24	V	1
	Temp. coefficient of V _{OUT}	$\frac{\Delta V_{OUT}}{\Delta T_a}$	V _{IN} = 5 V, I _{OUT} = 30 mA, Ta = -40°C to +85°C	—	± 0.23	± 0.92	mV/°C	1
	Power off output voltage	V _{OUTOFF}	V _{IN} = 5 V, V _{PF} = "L" R _L = 1 MΩ	—	—	0.1	V	6
Voltage detector	Operating voltage	V _{SEN}		1.3	—	24	V	2
	Temp. characteristic of -V _{DET}	$\frac{\Delta -V_{DET}}{\Delta T_a}$	Ta = -40°C to +85°C	—	± 0.3	± 1.2	mV/°C	2
	Detection voltage	-V _{DET}	S-873025C	2.440	2.500	2.560	V	2
			S-873024C	2.342	2.400	2.458	V	2
			S-873023C	2.244	2.300	2.356	V	2
			S-873022C	2.147	2.200	2.253	V	2
			S-873021C	2.049	2.100	2.151	V	2
	Sink current	I _{DOUT}	Nch V _{DS} = 0.5 V	V _{IN} = 1.3 V	0.25	0.60	—	mA
			V _{IN} = 2.4 V*	1.50	2.60	—	mA	4
Leakage current	I _{LEAK}	Nch V _{DS} = 24 V, V _{IN} = 10 V	—	—	0.1	μA	4	
Hysteresis width	V _{HYS}		3	—	8	%	2	
Current consumption	I _{SS}	V _{IN} = 5 V, Unloaded	—	3	8	μA	5	
	I _{of}	V _{PF} = "L": Power off, V _{IN} = 5 V	—	1.5	3.5	μA	5	
Shutdown input voltage	V _{IL}	V _{PF} = "L": Power off, V _{IN} = 5 V	—	—	0.4	V	6	
	V _{IH}	V _{PF} = "H": Power on, V _{IN} = 5 V	2.0	—	—	V	6	

* S-873025C only

■ **Test Circuits**

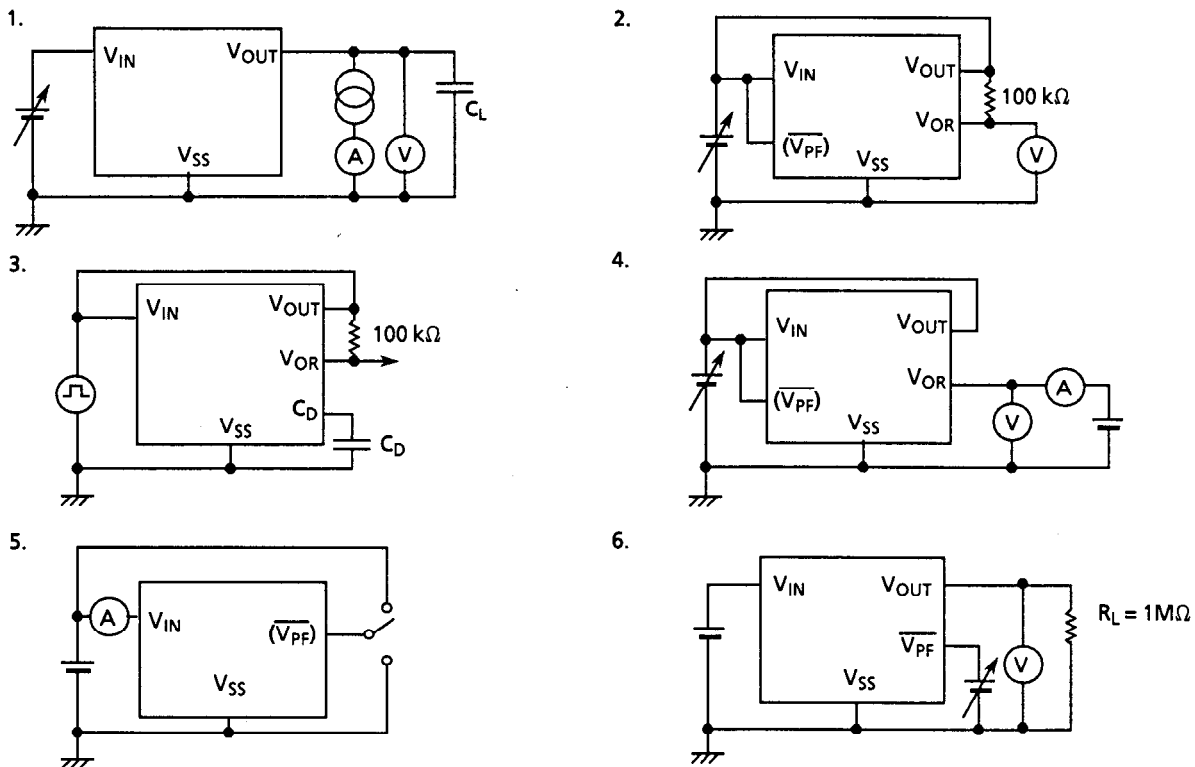

Figure 3 Test circuits

■ **Technical Terms**

- I/O voltage difference (V_{dif})

$$V_{dif} = V_{IN1} - V_{OUT1}$$

V_{OUT1} : Initial output voltage

V_{IN1} : Input voltage which generates an output voltage (V_{OUT2}) decreased by 5% from V_{OUT1}

- Load regulation (ΔV_{OUT2})

$$\Delta V_{OUT2} = V_{OUT1} - V_{OUT2}$$

V_{OUT1} : Output voltage when I_{OUT} is 50 μA

V_{OUT2} : Output voltage when I_{OUT} is 40 mA

- Line regulation (ΔV_{OUT1})

$$\Delta V_{OUT1} = V_{OUT1} - V_{OUT2}$$

V_{OUT1} : Output voltage when V_{IN} is 24 V

V_{OUT2} : Output voltage when V_{IN} is ($V_{OUT} + 1$) V

■ **Operation Timing Charts**

1. Voltage regulator (S-87XXXXC Series)

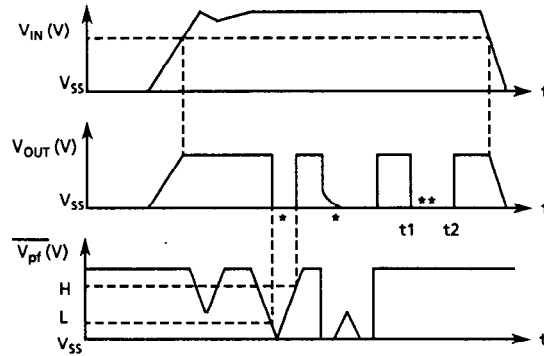

- * Indicates shutdown status. When load current (I_{OUT}) is less than $1 \mu A$, V_{OUT} is not always V_{SS} level.
- ** When V_{OUT} is shorted at t_1 , V_{OUT} becomes V_{SS} level. When short of V_{OUT} is removed at t_2 , V_{OUT} returns to normal.

Figure 4

2. Voltage detector (S-87XXXXA/B Series)

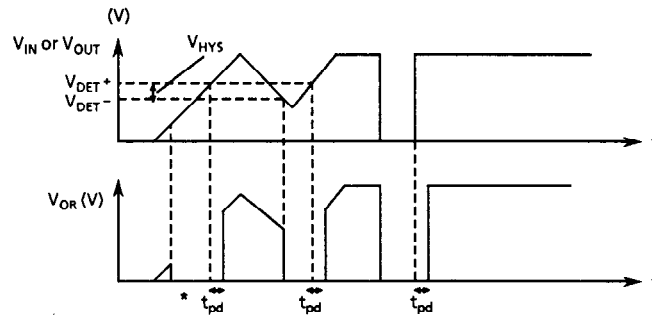

- * Output delay time (t_{pd}) of the voltage detector can be changed with an external capacitance value to C_D pin.
- ** Delay time is not available in S-87XXXXC Series.

Figure 5

■ **Operation**

1. Reference voltage circuit

The reference voltage circuits operate all the time while voltage is applied to V_{IN} pin independently of $\overline{V_{PF}}$ signal.

2. Voltage regulator

Figure 6 shows the voltage regulator circuit. The S-87X Series has a Pch MOS transistor as the output control transistor.

Reverse current may break IC if V_{OUT} potential is higher than V_{IN} , because a parasitic diode is formed between V_{IN} and V_{OUT} due to the structure of the control transistor. Therefore, keep V_{OUT} lower than $V_{IN} + 0.3$ V.

The output voltage of the voltage regulator can be selected as follows :

- 3V system : 2.9V to 3.4V (0.1V step) $\pm 2.4\%$
- 5V system : 4.7V to 5.2V (0.1V step) $\pm 2.4\%$

Note For an application with a load current of less than 1 μA , the leakage current of the control transistor M1 increases the output voltage.

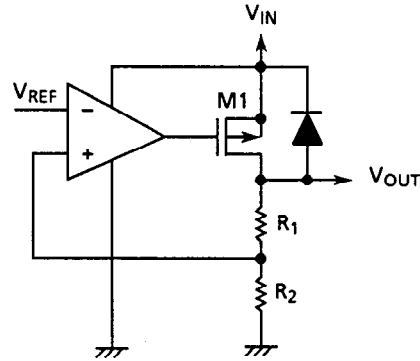

Figure 6 Voltage regulator circuit

3. Short-circuit protection circuit

The S-87X Series has a built-in short-circuit protection circuit to protect the element from break caused by a large current in case of a short circuit. The output short current is internally limited to approx. 70 mA. Short-circuit protection circuit has three kinds characteristics according to V_{IN} (input voltage) as shown in Figure 7.

At 5-V output:

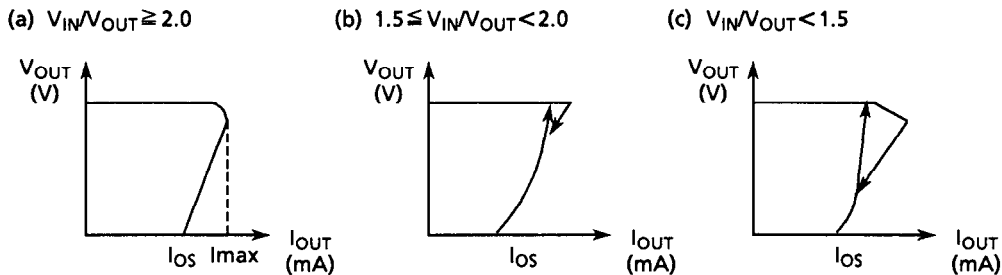

Figure 7

Note Use a voltage regulator with I_{OS} under the specified power dissipation of the package.

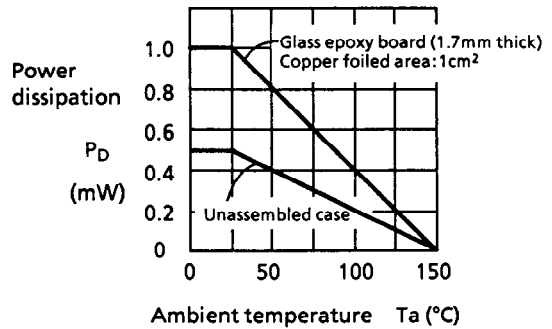

Figure 8 Power dissipation of the package (when not mounted)

4. Delay circuit

The delay circuit outputs voltage detector output (V_{OR}) with delay after the voltage at V_{IN} pin has become release voltage ($+V_{DET}$) at the rising of V_{IN} pin.

In Fig. 9, when V_{cd} exceeds the reference voltage (V_{ref}), the output voltage pin V_{OR} changes from low to high level, providing delay output. When the voltage at V_{IN} pin falls under the detection voltage ($-V_{DET}$), the N_2 transistor turns ON, therefore the charge of C_D is rapidly discharged and the voltage detector output (V_{OR}) changes from high to low level without delay.

The external capacitor (C_D) is charged with constant current, and is practically independent of V_{IN} voltage. Its delay time (t_{pd}) is expressed by the following equation:

$$t_{pd} \text{ (ms)} = \text{Delay coefficient (3.18 min., 5.74 typ., 8.73 max.)} \times C_D \text{ (nF)}$$

Note · Unless an output delay is needed, keep C_D pin open.

Do not apply external voltage other than ground potential to C_D pins, which may cause IC breakdown.

- When designing your printed-circuit board layout, take care that no leakage current flows to the external capacitor (C_D), otherwise the correct delay time may not be obtained. Because the value of the constant current source I_C is only 195 nA, C_D terminal impedance is high.

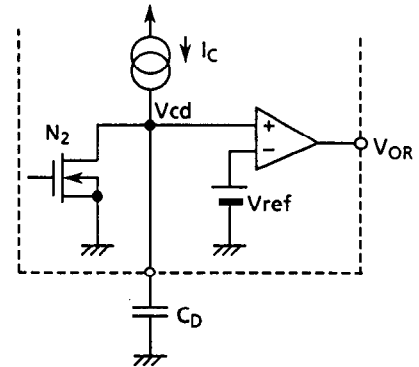

Figure 9 Delay circuit

5. Voltage detection circuit

The built-in voltage detection circuit (Nch opendrain type) is equivalent to our S-807 Series voltage detectors. A pull-up resistor of 100 k Ω is required for output. Since the comparator power of this circuit is supplied from V_{IN} pin, this circuit operates while voltage is applied to V_{IN} pin.

The detection voltage of the voltage detector can be selected as follows :

3V system : 2.0V to 3.0V (0.1V step) $\pm 2.4\%$

5V system : 3.7V to 4.7V (0.1V step) $\pm 2.4\%$

6. Shutdown circuit (S-87XXXXC Series)

In the S-87XXXXC Series, when $\overline{V_{PF}}$ pin goes low (0.4 V or less), current for the voltage regulator is shut down, with the current consumption (excluding the current which flows through the pull-up resistor) lowered to 3.5 μ A or less.

During shutdown, the M1 transistor in the voltage regulator shown in the Figure 6 is off and V_{OUT} pin is pulled down by R1 and R2, whose value ($R1 + R2$) is 5M Ω to 10M Ω .

Note

- The output voltage may not become 0 V if a load making I_{OUT} under 50 μ A is connected during shutdown, .
- Do not keep $\overline{V_{PF}}$ pin floating state or in medium potential (between low and high levels) , Otherwise a through-type current occurs.

HIGH WITHSTAND-VOLTAGE VOLTAGE REGULATOR WITH RESET FUNCTION
S-87X Series

■ **Dimensions**

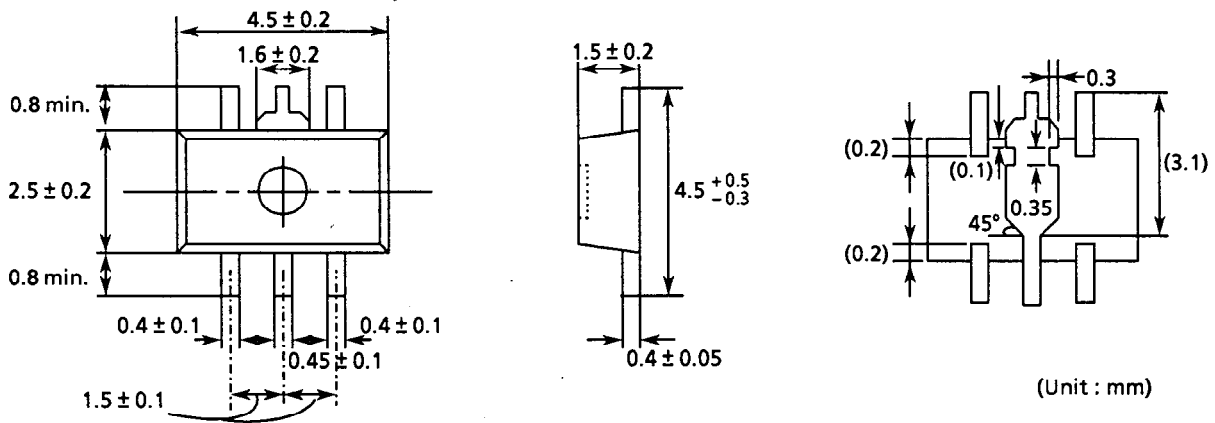
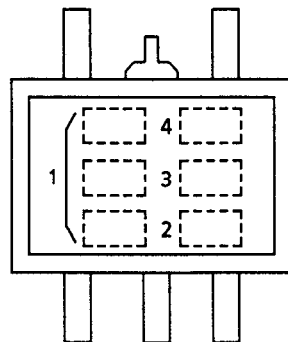

Figure 10 Dimensions

■ **Markings**



- 1 : Product name (abbreviation.)
- 2 : Year of assembly
- 2 : Month of assembly
- 3 : Week of assembly

Figure 11 Markings

■ Taping

1 Tape specifications

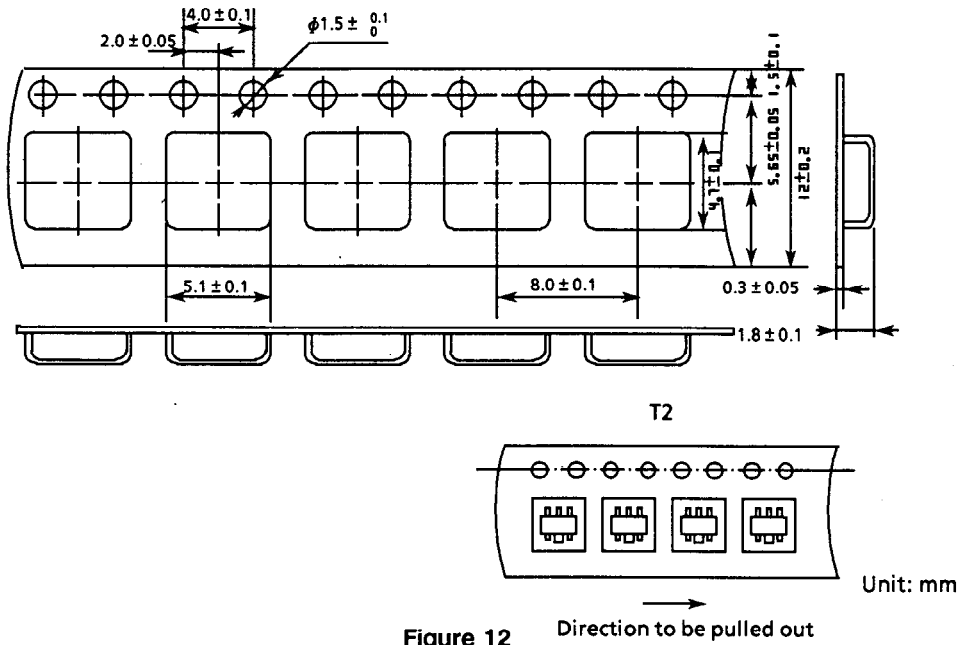

Figure 12

2. Reel specifications

1 reel holds 1000 regulators.

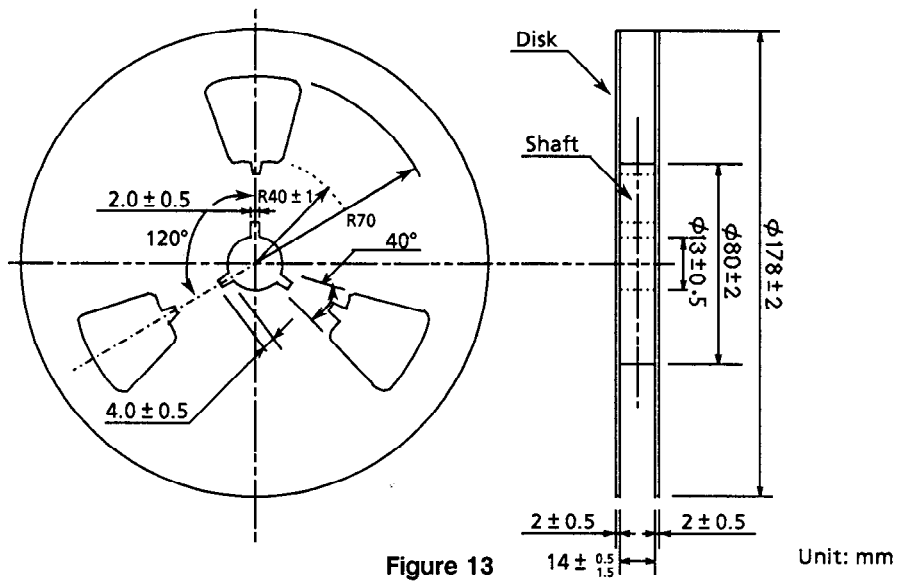

Figure 13

■ **Transient Response**

An undershoot or an overshoot may occur in the output voltage of the voltage regulator if input voltage or load current fluctuates transiently. If an undershoot is large, the voltage detector operates to output reset signal in the S-87XXXXB Series in which the voltage detector detects the output voltage of the regulator. If an overshoot is large, the load circuit is adversely affected. Therefore it is important to determine the capacitor value so as to minimize undershoot and overshoot.

1. Line transient response due to input voltage fluctuation

Input voltage fluctuation differs depending on the types of the signal applied: type I which is a rectangular wave between $(V_{OUT} + 1)$ V and 10 V, and type II which is a rectangular wave from 0 V to 10 V (see Figure 14). The ringing waveforms and parameter dependency of each type are described below. The measuring circuit is shown in Figure 15 for reference.

Type I: Rectangular wave between $(V_{OUT} + 1)$ V and 10 V

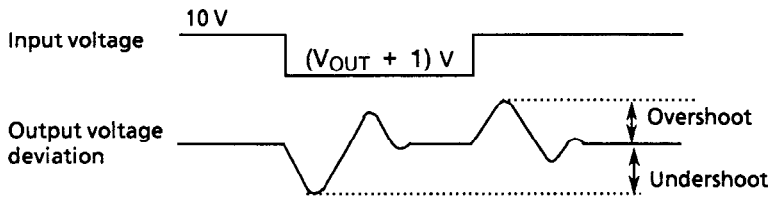

Type II: Rectangular wave from 0 V to 10 V

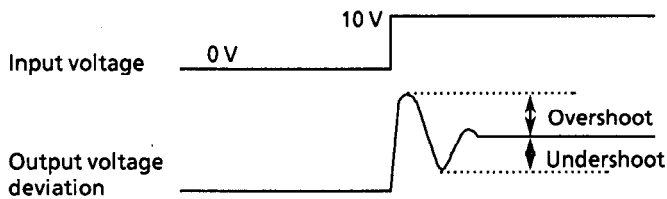

Rise/fall time (time between 10% and 90%) is 1 μ s.

Figure 14

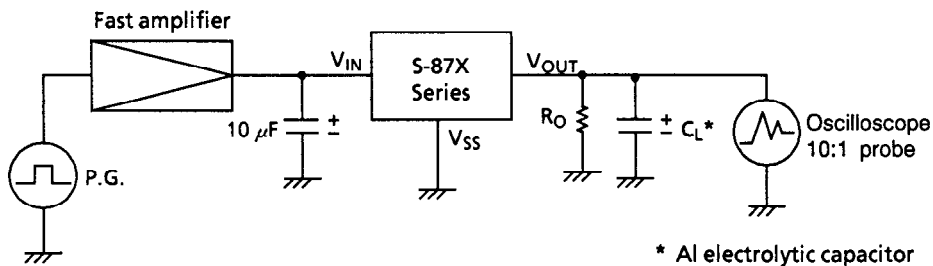

Figure 15 Measuring circuit

Type I

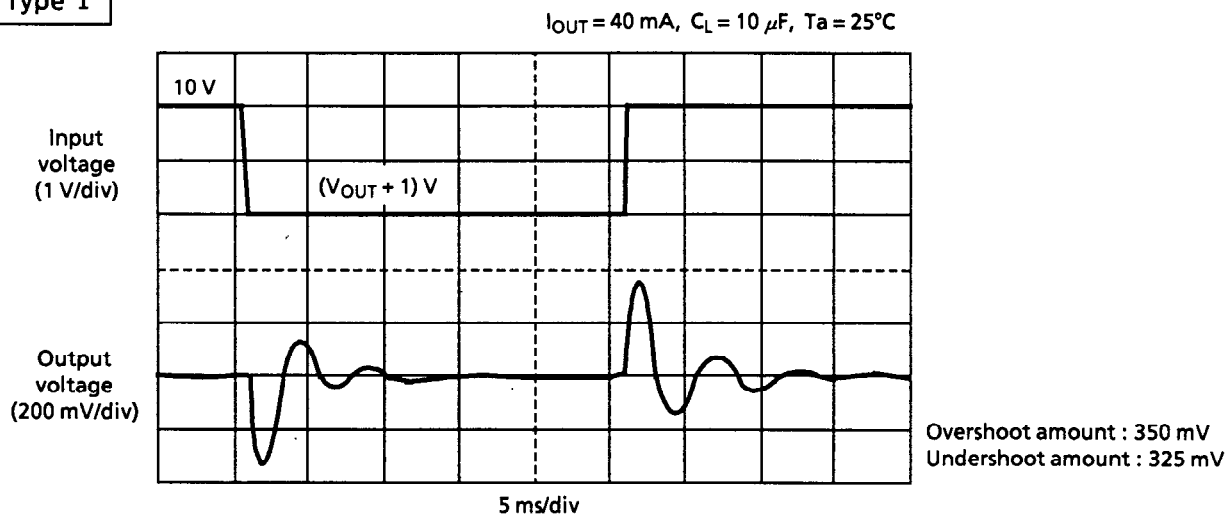

Figure 16 Type I ringing waveform

Table 10 Type I parameter dependency

Series	Parameter	Conditions	Method to decrease overshoot	Method to decrease undershoot
S-8750XXX	Load current I_{OUT}	10 to 60 mA, $C_L = 10 \mu\text{F}$	Decrease	Decrease
	Load capacitance C_L	1 to 47 μF , $I_{OUT} = 40 \text{ mA}$	Increase	Increase
	Input fluctuation ΔV_{IN}^*	3 to 5 V 5 to 19 V	Decrease	Decrease
			Increase	Decrease
Temperature T_a	-40°C to +85°C	Low temperature	Low temperature	
S-8730XXX	Load current I_{OUT}	10 to 60 mA, $C_L = 10 \mu\text{F}$	Increase	Decrease
	Load capacitance C_L	1 to 47 μF , $I_{OUT} = 40 \text{ mA}$	Increase	Increase
	Input fluctuation ΔV_{IN}^*	5 to 21 V	Increase	Decrease
	Temperature T_a	-40°C to +85°C	Low temperature	Low temperature

* ΔV_{IN} : High voltage value – low voltage value

Type II

$I_{OUT} = 40 \text{ mA}$, $C_L = 10 \mu\text{F}$, $T_a = 25^\circ\text{C}$

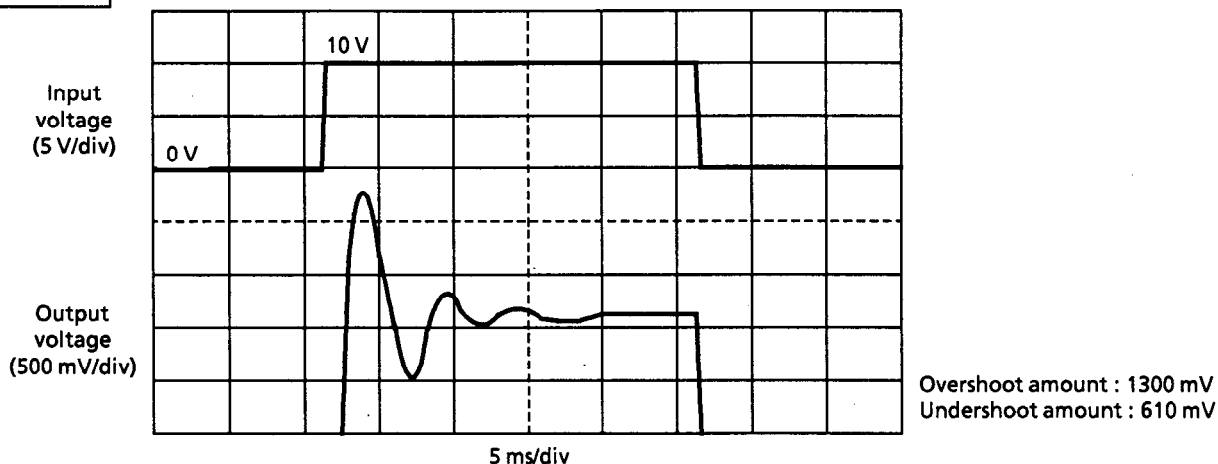

Figure 17 Type II ringing waveform

Table 11 Type II parameter dependency

Series	Parameter	Conditions	Method to decrease overshoot	Method to decrease undershoot
S-8750XXX	Load current I_{OUT}	10 to 60 mA, $C_L = 10 \mu\text{F}$	Increase	Increase
	Load capacitance C_L	1 to 47 μF , $I_{OUT} = 40 \text{ mA}$	Decrease	Decrease
	Input fluctuation ΔV_{IN}^*	3 to 19 V	Increase	Increase
	Temperature T_a	-40°C to $+85^\circ\text{C}$	Low temperature	Low temperature
S-8730XXX	Load current I_{OUT}	10 to 60 mA, $C_L = 10 \mu\text{F}$	Increase	Increase
	Load capacitance C_L	1 to 47 μF , $I_{OUT} = 40 \text{ mA}$	Decrease	Decrease
	Input fluctuation ΔV_{IN}^*	5 to 21 V	Increase	Increase
	Temperature T_a	-40°C to $+85^\circ\text{C}$	Low temperature	Low temperature

* ΔV_{IN} : High voltage value – low voltage value

For reference, the following pages describe the ringing in V_{OUT} measured using the output load current (I_{OUT}), output load capacitance (C_L), input fluctuation width (ΔV_{IN}), and temperature as parameters.

Reference data: Type I **S-8750XXX series**

1. I_{OUT} dependency

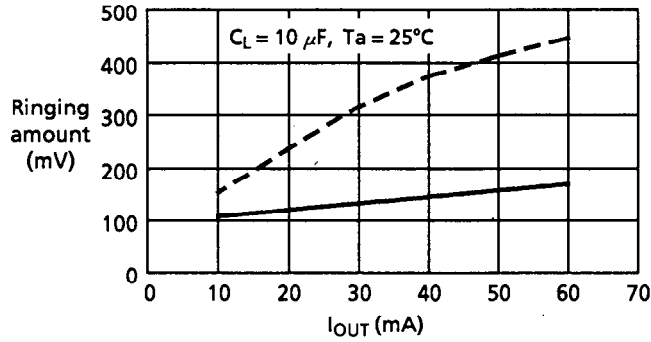

2. C_L dependency

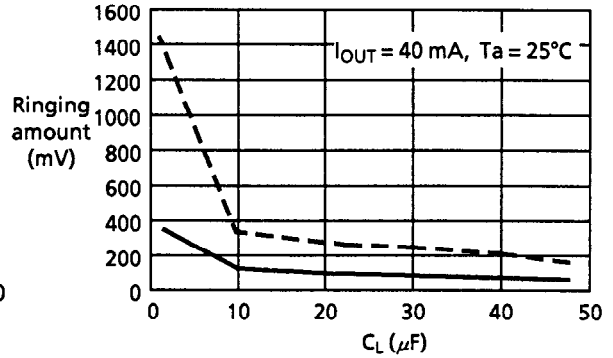

3. ΔV_{IN} dependency

The lower voltage is fixed at $(V_{OUT} + 1)$.

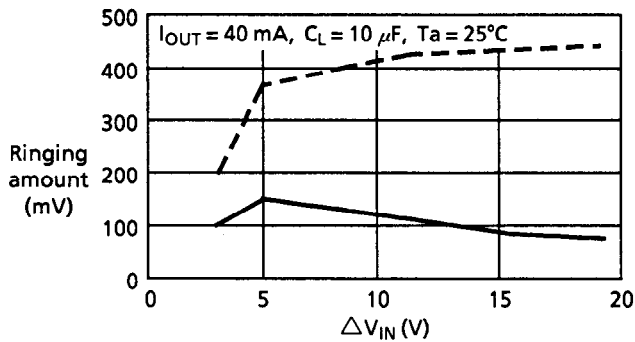

4. Temperature dependency

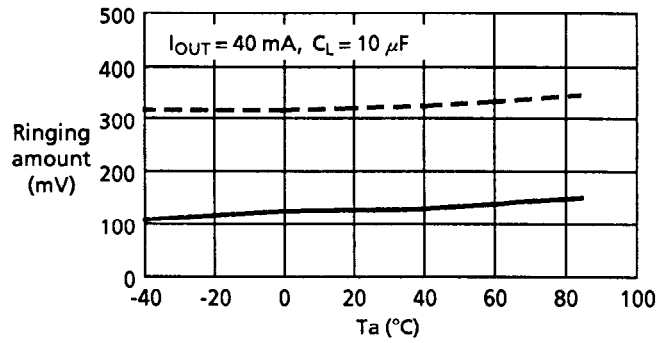

— Undershoot
 - - - Overshoot

Reference data: Type I **S-8730XXX series**

1. I_{OUT} dependency

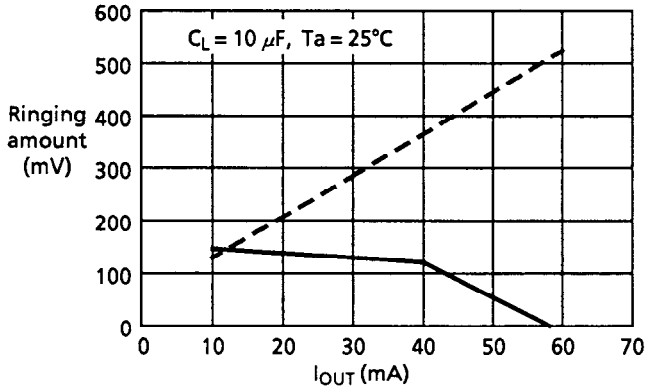

2. C_L dependency

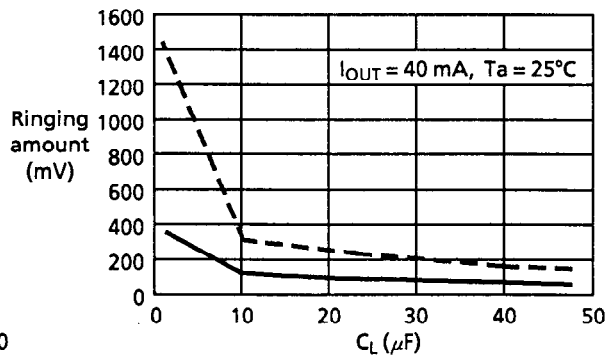

3. ΔV_{IN} dependency

The lower voltage is fixed at $(V_{OUT} + 1)$.

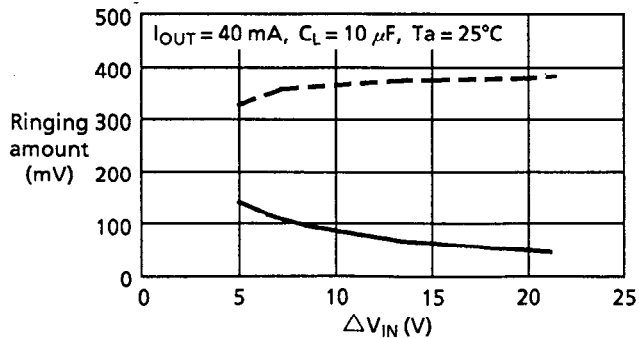

4. Temperature dependency

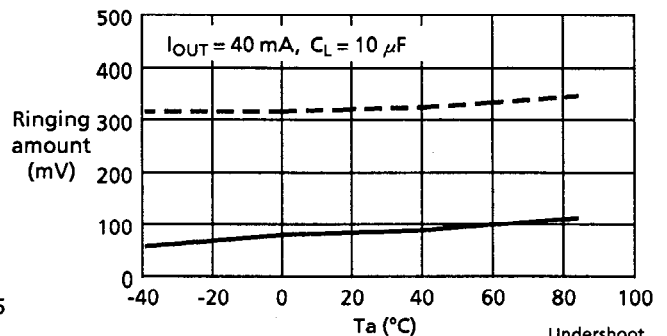

— Undershoot
 - - - Overshoot

HIGH WITHSTAND-VOLTAGE VOLTAGE REGULATOR WITH RESET FUNCTION

S-87X Series

Reference data: Type II S-8750XXX series

1. I_{OUT} dependency

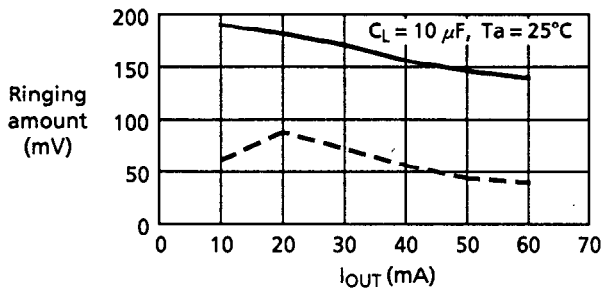

2. C_L dependency

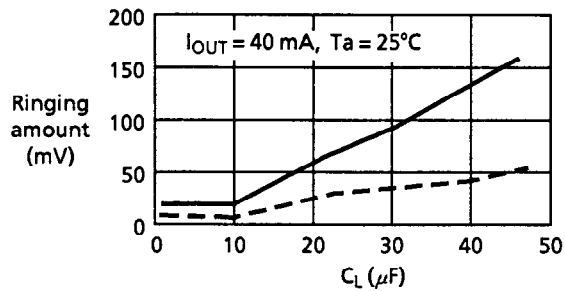

3. ΔV_{IN} dependency
The lower voltage is fixed at ($V_{OUT} + 1$).

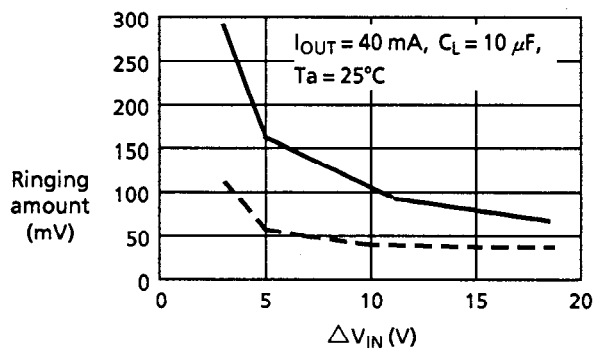

4. Temperature dependency

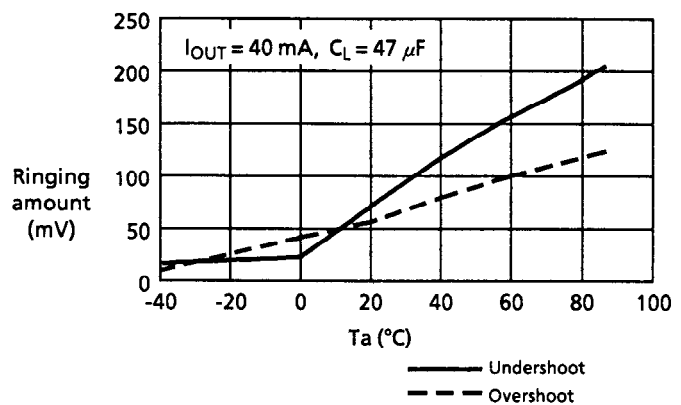

Reference data: Type II S-8730XXX series

1. I_{OUT} dependency

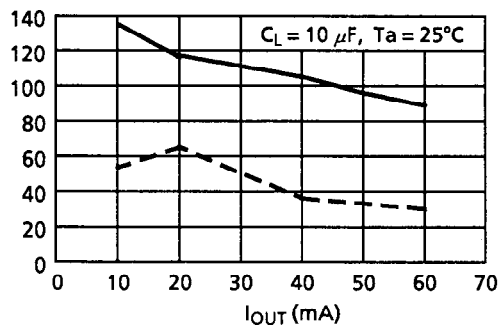

2. C_L dependency

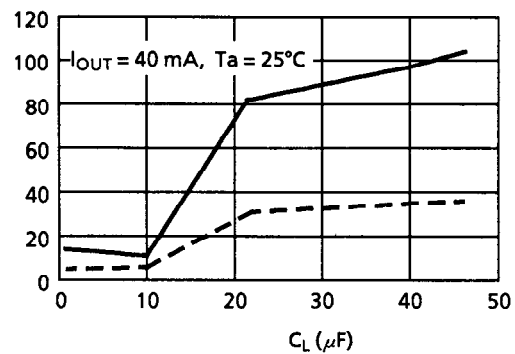

3. ΔV_{IN} dependency
The lower voltage is fixed at ($V_{OUT} + 1$).

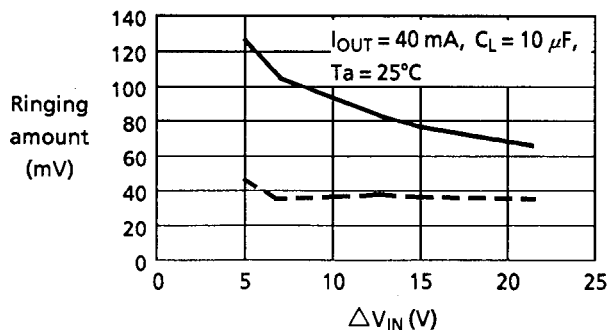

4. Temperature dependency

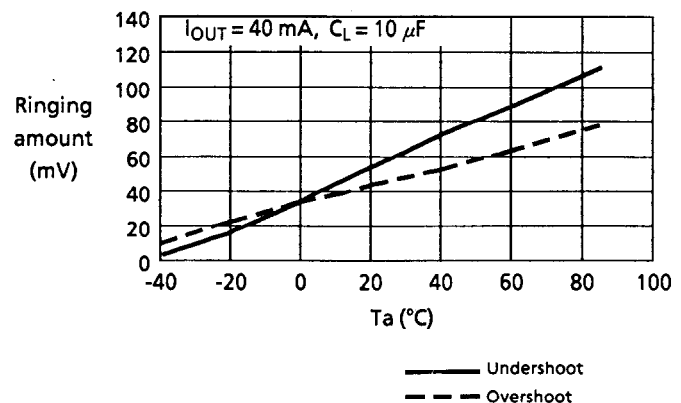

2. Load transient response due to load current fluctuation

An overshoot and an undershoot are caused in the output voltage if the load current is changed from 50 μA to 40 mA while the input voltage is kept constant. Figure 18 shows the output voltage fluctuation due to a change in the load current. The measuring circuit is shown in Figure 19 for reference. The latter half of this section describes ringing waveform and parameter dependency.

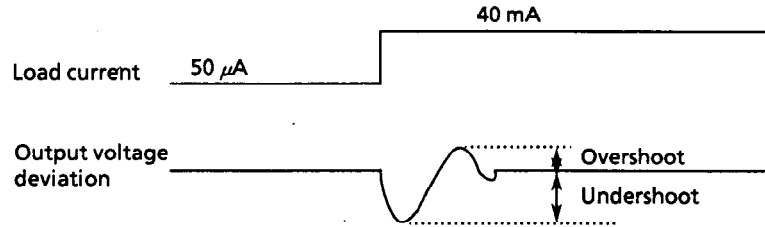
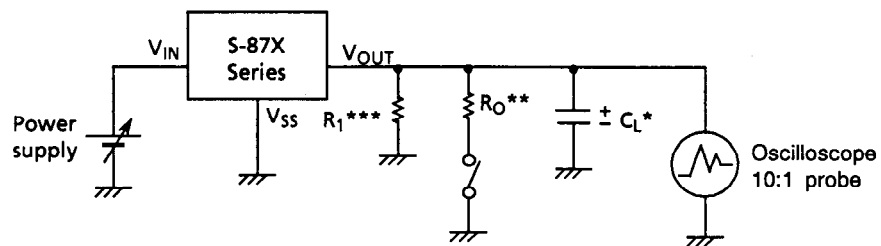

Figure 18



* Al electrolytic capacitor

$$** R_0 = \frac{V_{OUT} [V]}{40 \text{ mA}} [\Omega]$$

$$*** R_1 = \frac{V_{OUT} [V]}{50 \mu\text{A}} [\Omega]$$

Figure 19 Measuring circuit

Table 12 Parameter dependency due to load current fluctuation

Series	Parameter	Conditions	Method to decrease overshoot	Method to decrease undershoot
S-8750XXX S-8730XXX	Load current I_{OUT}	10 to 60 mA, $C_L = 10 \mu\text{F}$	Decrease	Decrease
	Load capacitance C_L	1 to 47 μF , $I_{OUT} = 40 \text{ mA}$	Increase	Increase
	Power supply voltage V_{IN}	$(V_{OUT} + 1)$ to 24 V	Increase	Increase
	Temperature T_a	-40°C to +85°C	Low temperature	Low temperature

HIGH WITHSTAND-VOLTAGE VOLTAGE REGULATOR WITH RESET FUNCTION

S-87X Series

Reference data S-8750XXX Series

1. I_{OUT} dependency

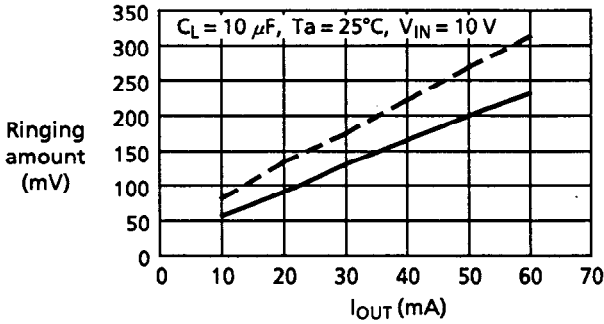

2. C_L dependency

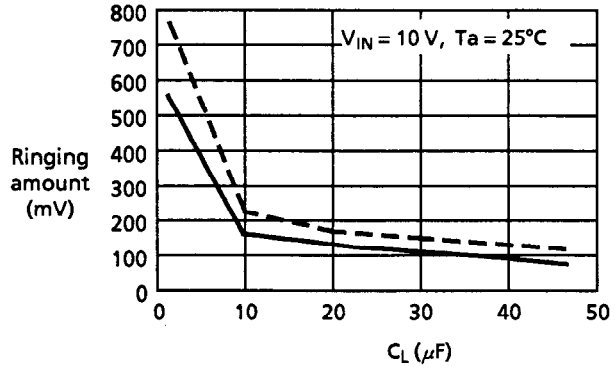

3. V_{IN} dependency

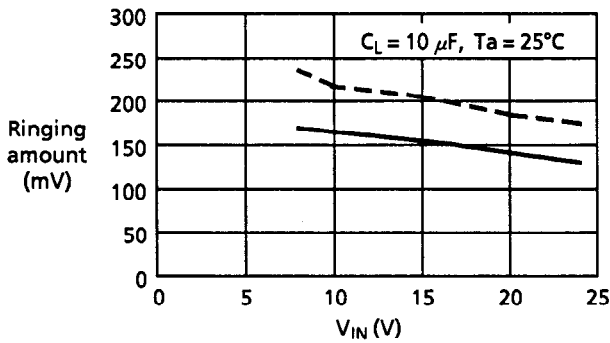

4. Temperature dependency

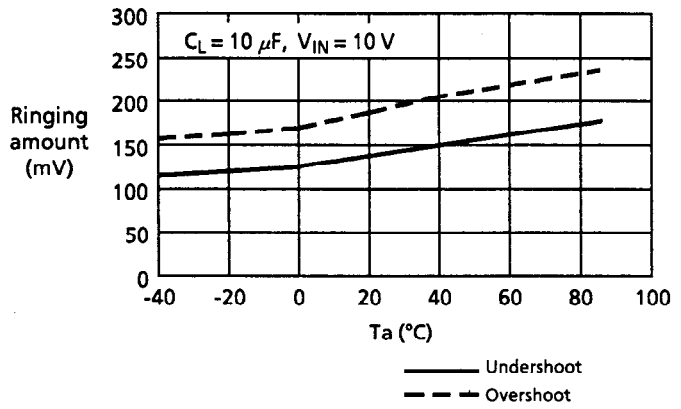

Reference data S-8730XXX Series

1. I_{OUT} dependency

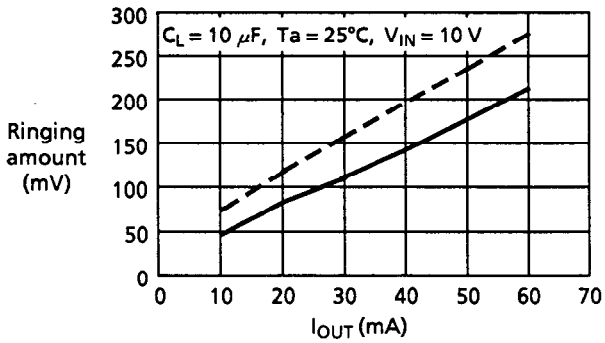

2. C_L dependency

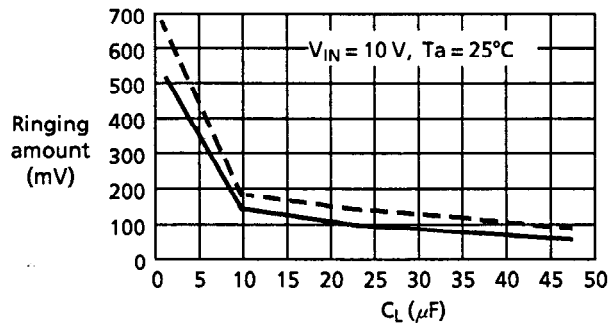

3. V_{IN} dependency

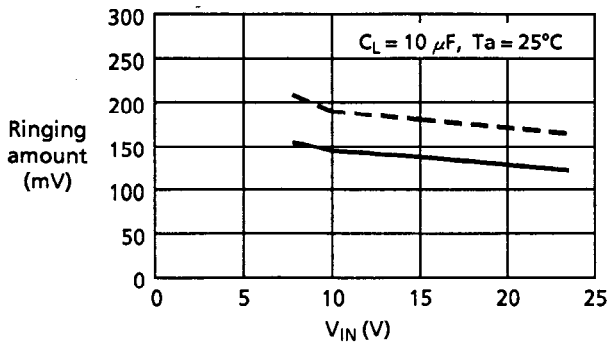

4. Temperature dependency

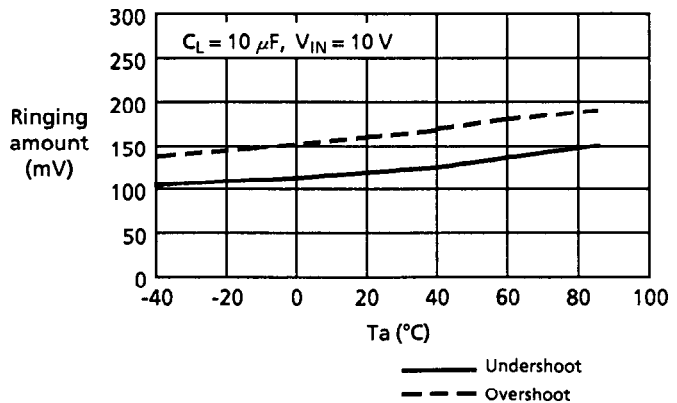

■ **Standard Circuits**

1. S-87XXXXA/B

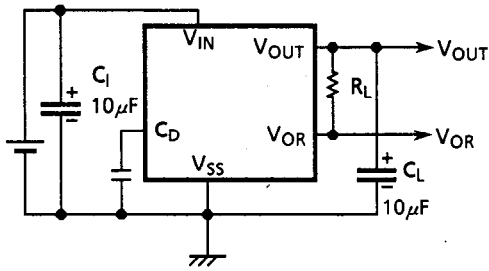

2. S-87XXXXC

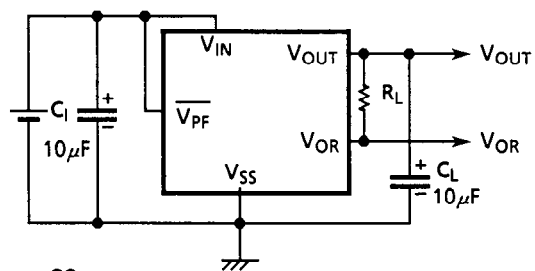

Figure 20

■ **Application Circuits**

1. Microcomputer power supply and reset circuit

To construct a microcomputer power supply and a reset circuit using conventional ICs, a voltage regulator IC, a voltage detector IC, a delay time generation circuit and others are required. The S-87XXXXA/B Series allows you to make these circuits without these ICs, and the delay time is variable.

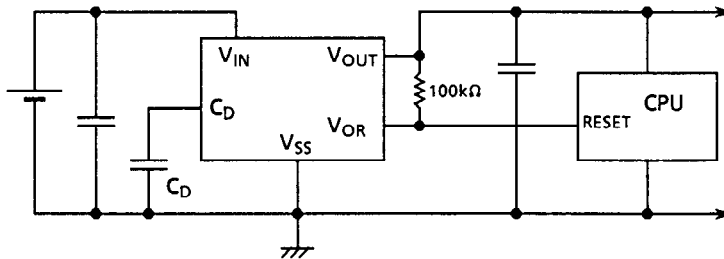
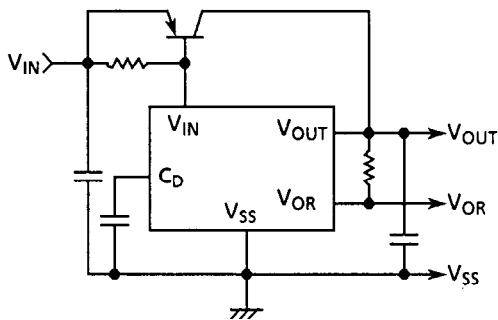

Figure 21

2. Circuit for increasing output current

A PNP transistor is used to increase the output current.

1. S-87XXXXA/B



2. S-87XXXXC

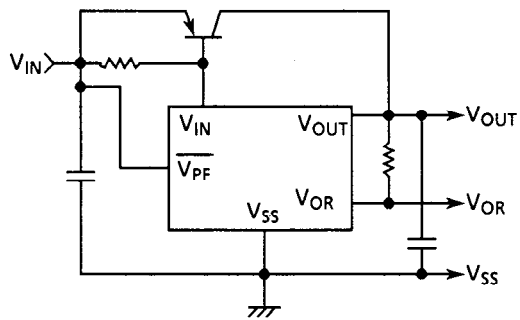

Figure 22

■ Notes

- Do not apply a ripple voltage of the conditions below to V_{IN} terminal.

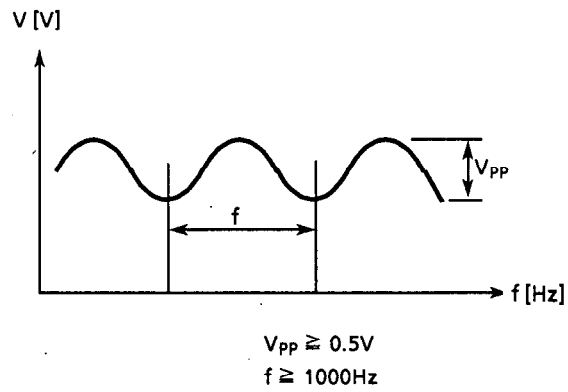

Figure 23

- When connecting the voltage regulator output terminal to another power supply, please insert a diode to protect the IC.

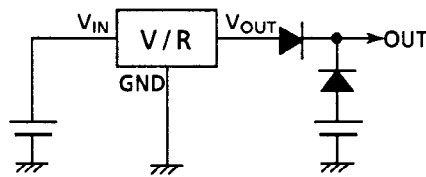
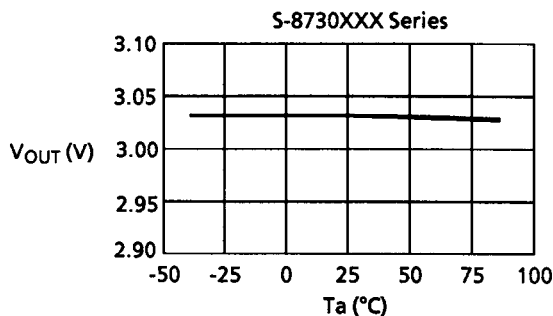
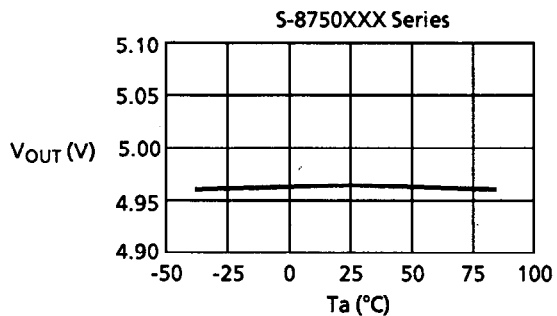

Figure 24

■ **Characteristics**

1. Voltage regulator

(1) Output voltage (V_{OUT}) - Temperature (T_a)



(2) Line regulation - Temperature (T_a)

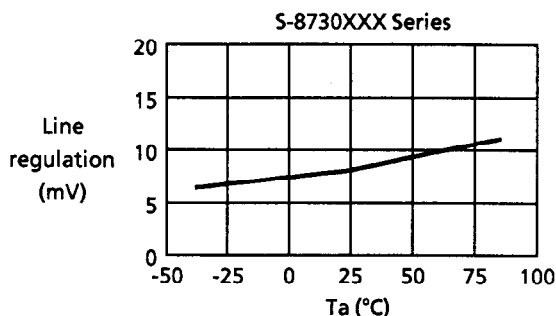
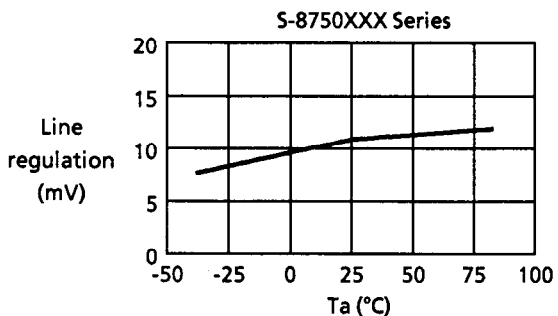

(3) Input voltage (V_{IN}) - Output voltage (V_{OUT})

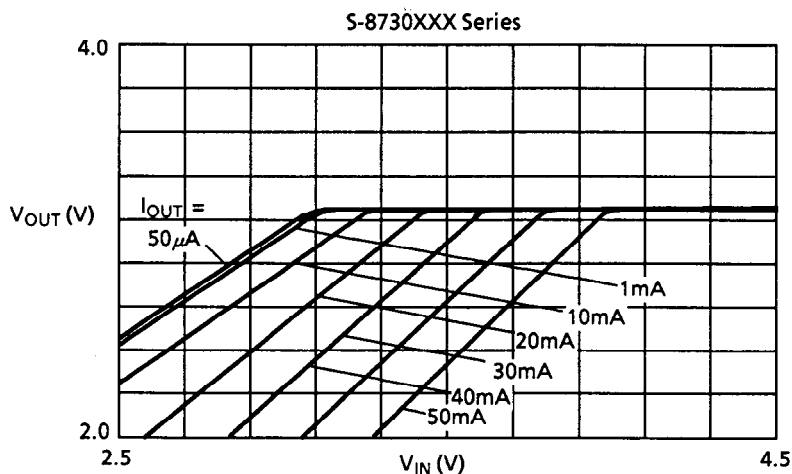
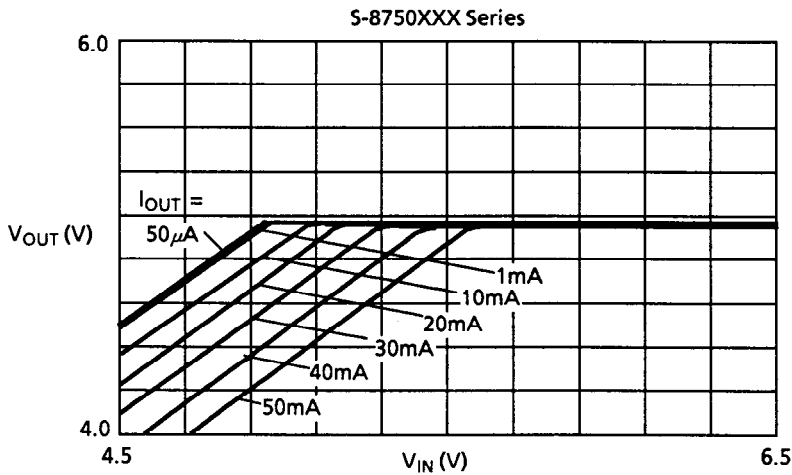

HIGH WITHSTAND-VOLTAGE VOLTAGE REGULATOR WITH RESET FUNCTION

S-87X Series

(4) Load regulation – Temperature (T_a)

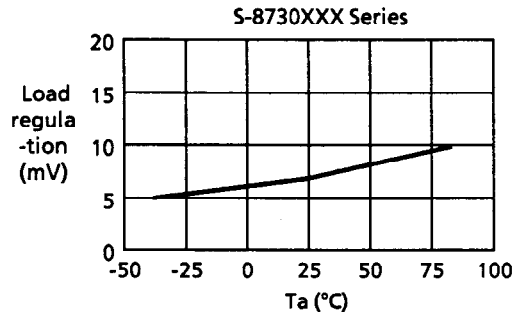
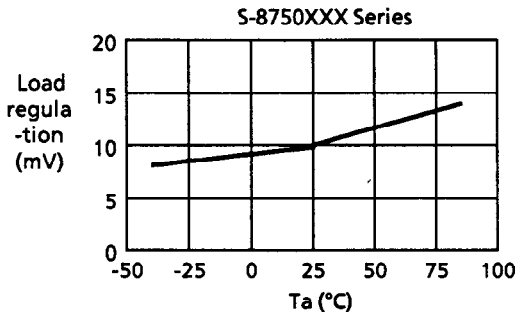

(6) I/O voltage difference (V_{dif}) – Temperature (T_a)

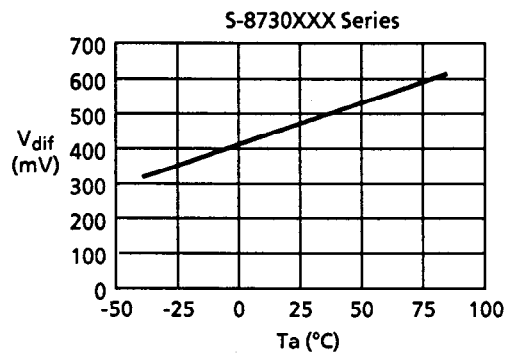
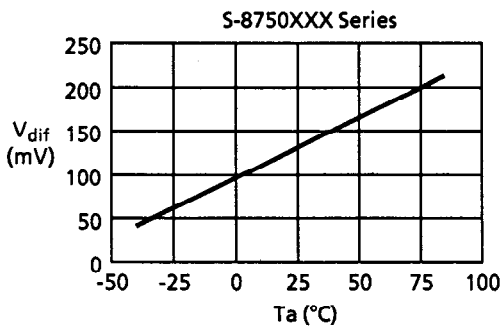

(7) Short-circuit protection circuit

S-8750XXX Series $T_a = 25^\circ\text{C}$

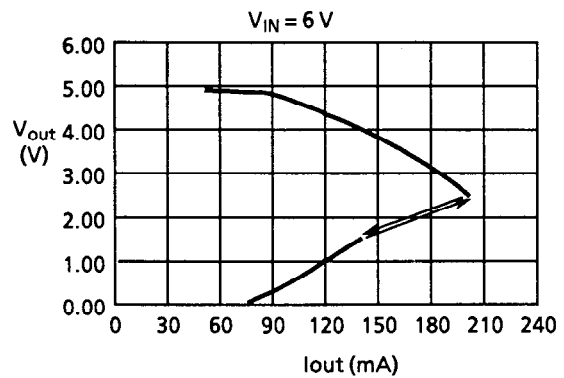
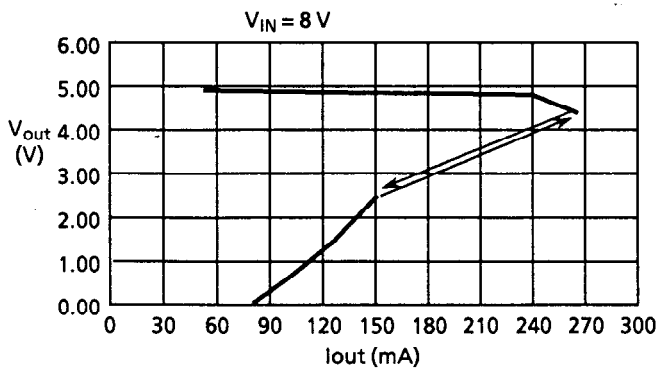
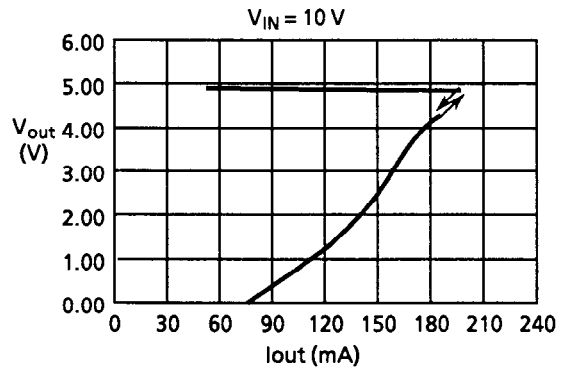
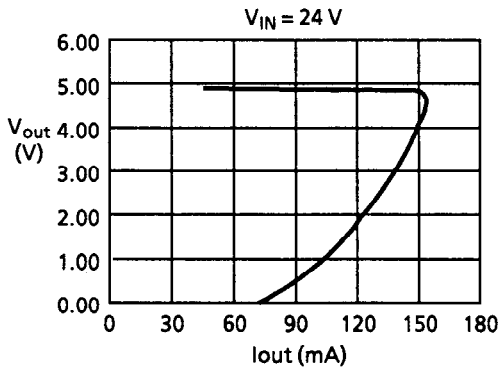

HIGH WITHSTAND-VOLTAGE VOLTAGE REGULATOR WITH RESET FUNCTION

S-87X Series

S-8730XXX Series $T_a = 25^\circ\text{C}$

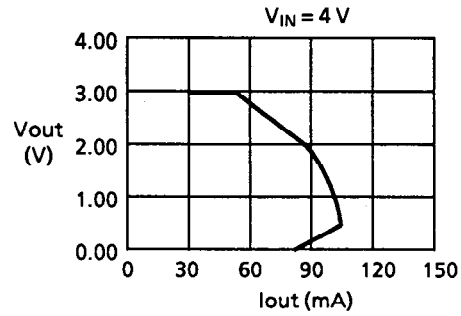
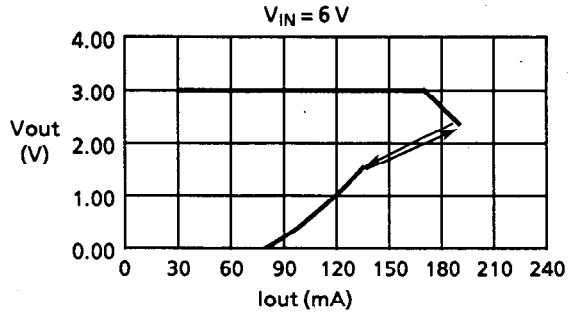
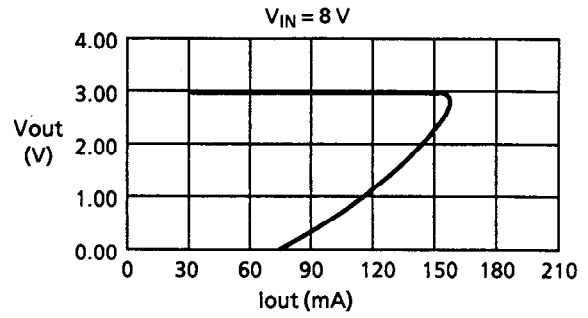
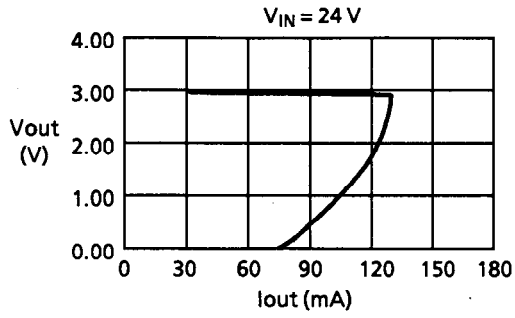

(7) Ripple rejection

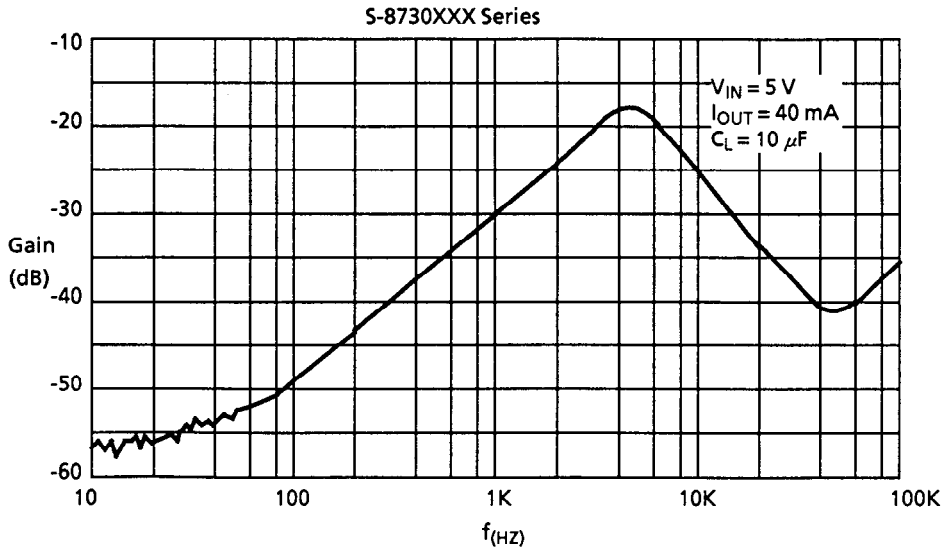
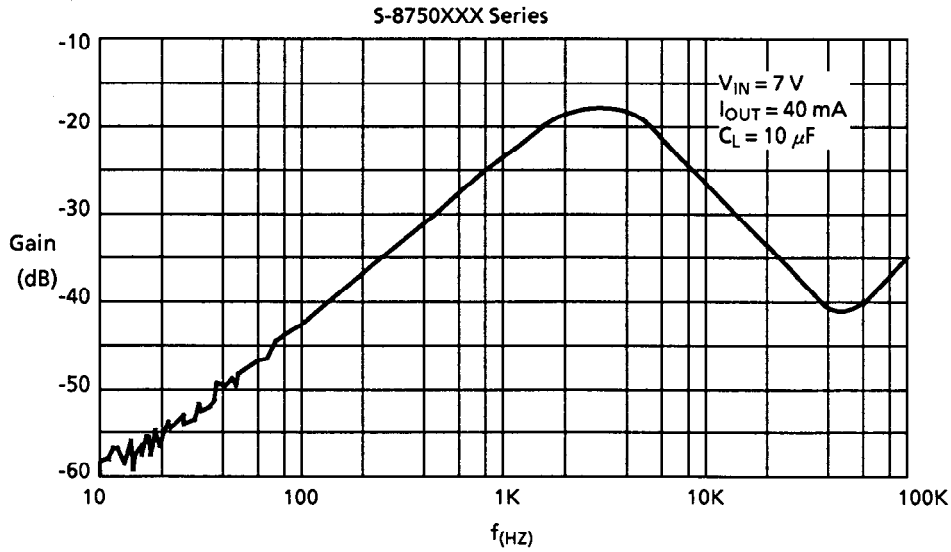

HIGH WITHSTAND-VOLTAGE VOLTAGE REGULATOR WITH RESET FUNCTION

S-87X Series

2. Voltage detector

(1) Detection voltage (V_{DET}) - Temperature (T_a)

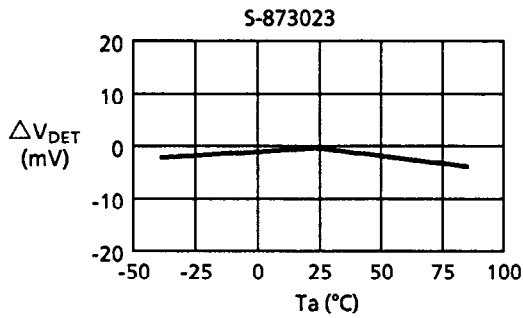
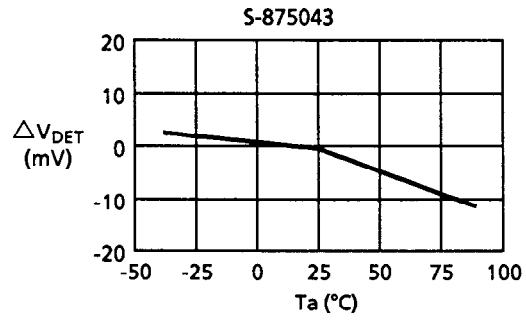
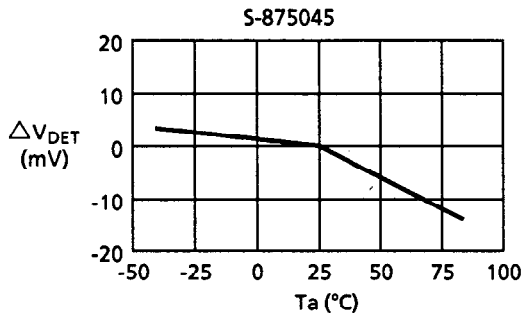

(2) Hysteresis width (V_{HYS}) - Temperature (T_a)

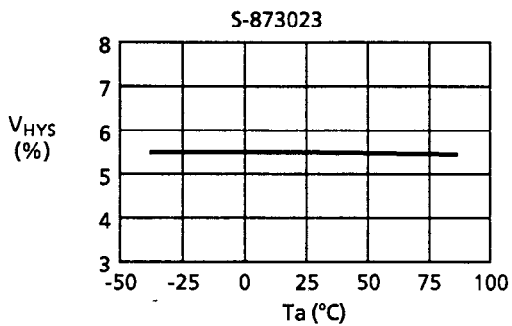
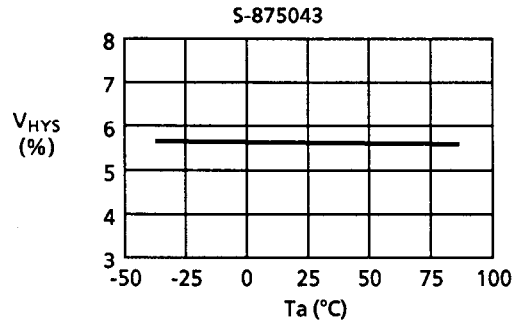
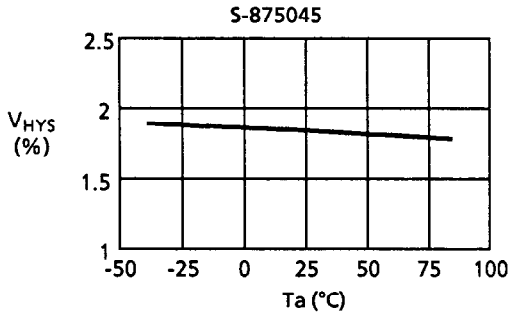

(3) Nch transistor output current (I_{dout})

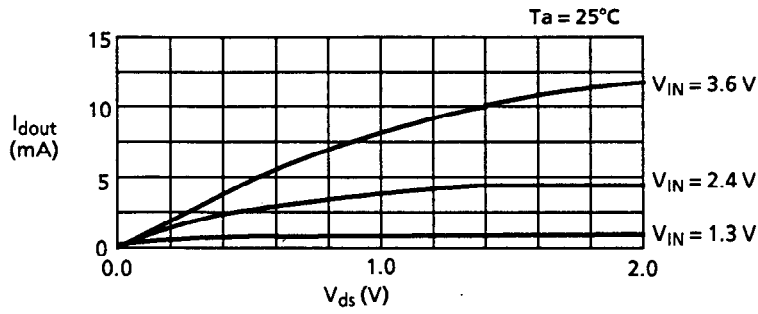

(4) Delay time (t_{pd})

(a) Delay time (t_{pd}) - Temperature (T_a)

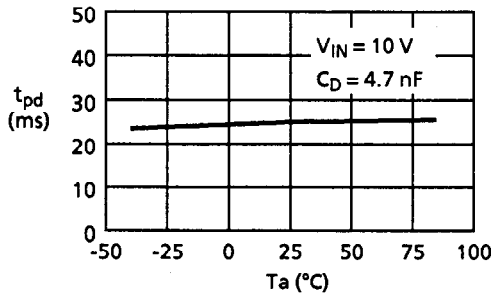

3. Total

(1) Current consumption (I_{ss})

(a) Input voltage (V_{IN})

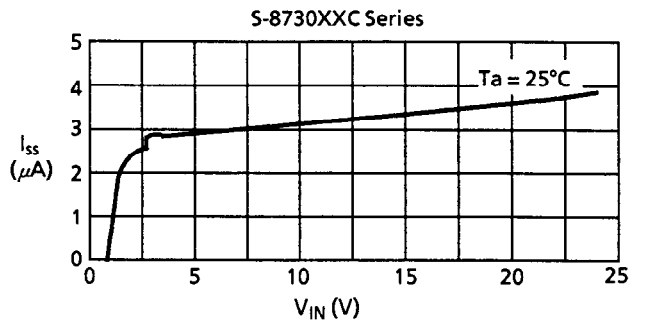
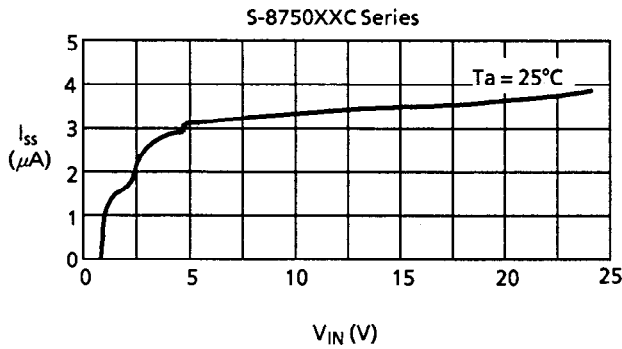

(b) Current consumption (I_{ss}) - Temperature (T_a)

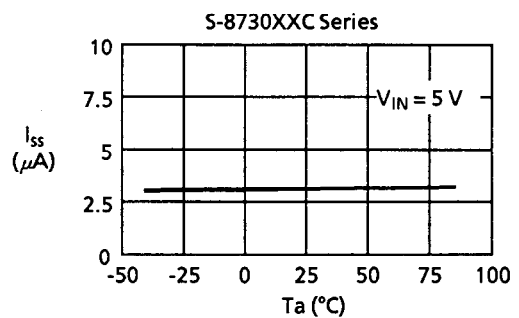
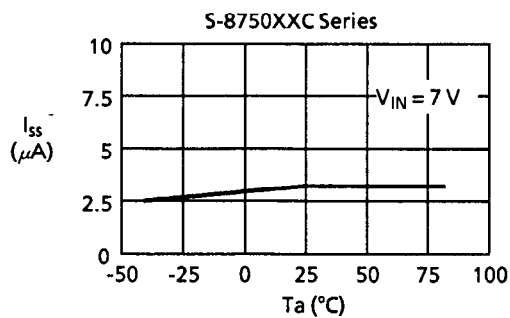

HIGH WITHSTAND-VOLTAGE VOLTAGE REGULATOR WITH RESET FUNCTION
S-87X Series

(2) Input voltage of shutdown circuit

(a) High level input voltage (V_{IH}) - Temperature (T_a)

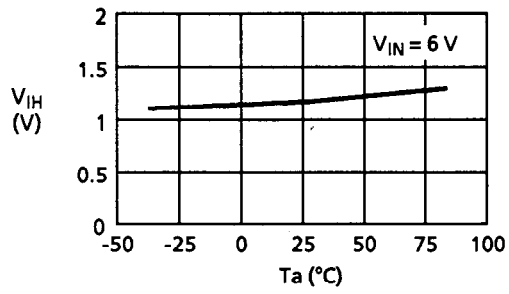

(b) Low level input voltage (V_{IL}) - Temperature (T_a)

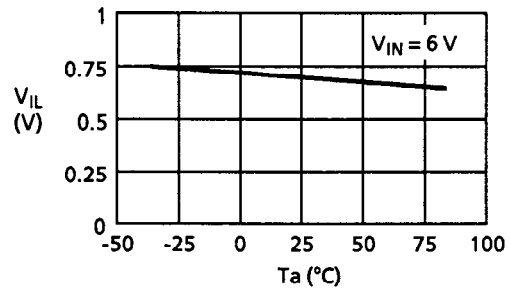

(c) V_{IH} , V_{IL} - power supply voltage dependency

