

# Preliminary Data Sheet

## Features

- For GPS applications
- Usable bandwidth 2 MHz
- Super low loss
- High attenuation
- No impedance matching required for operation at 100  $\Omega$
- Single-ended input
- Balanced output
- Superior amplitude and phase balance
- Ceramic Surface Mount Package (SMP)
- Small size

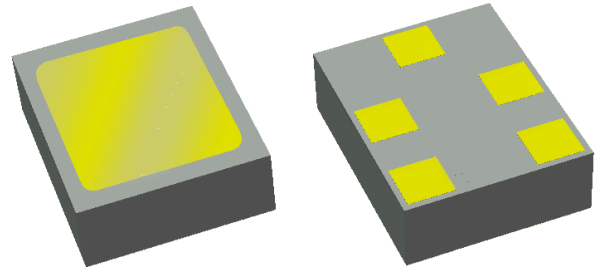

## Package

Surface Mount 2.50 x 2.00 x 0.76 mm

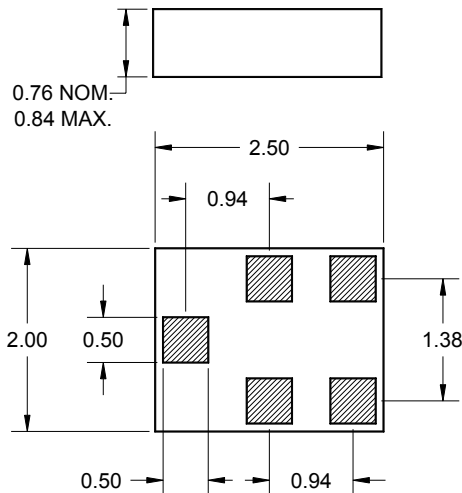

Dimensions shown are nominal in millimeters  
 All tolerances are  $\pm 0.10\text{mm}$

Body:  $\text{Al}_2\text{O}_3$  ceramic  
 Lid: Kovar or Alloy 42, Au over Ni plated  
 Terminations: Au plating 0.5 - 1.0  $\mu\text{m}$ ,  
 over a 2 - 6  $\mu\text{m}$  Ni plating

## Pin Configuration

Bottom View

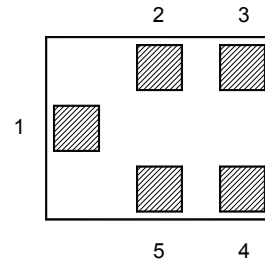

Pin No.	Description
1	Input
2,5	Case ground
3,4	Balanced output

# Preliminary Data Sheet

## Electrical Specifications <sup>(1)</sup>

Operating Temperature: <sup>(2)</sup> +25 °C

Parameter <sup>(3)</sup>	Minimum	Typical	Maximum	Unit
<b>Center Frequency</b>	-	1575.42	-	MHz
<b>Maximum Insertion Loss</b> 1574.42 - 1576.42 MHz	-	1.4	1.5	dB
<b>Absolute Attenuation</b>				
DC - 1450 MHz	30	38	-	dB
1450 - 1475 MHz	27	31	-	dB
1475 - 1525 MHz	15	26	-	dB
1625 - 1675 MHz	12	14	-	dB
1675 - 1775 MHz	20	22	-	dB
1775 - 3155 MHz	30	35	-	dB
3155 - 6000 MHz	35	45	-	dB
<b>Input/Output Return Loss</b> 1574.42 - 1576.42 MHz	10	16	-	dB
<b>Output Amplitude Balance ( S<sub>31</sub>/S<sub>21</sub> )</b> 1574.42 - 1576.42 MHz	-	0.5	0.75	dB
<b>Output Phase Balance <math>\phi(S_{31}) - \phi(S_{21})</math></b> 1574.42 - 1576.42 MHz	180	185	190	degree
<b>Nominal Source Impedance</b>	-	50	-	$\Omega$
<b>Optimal Load Impedance (balanced) <sup>(4)</sup></b>	-	120 + j35	-	$\Omega$

### Notes:

1. All specifications are based on the test circuit shown below
2. This specification is valid for room temperature only. The specification over the full temperature range(s) is available on the next page(s)
3. Electrical margin has been built into the design to account for the variations due to manufacturing tolerances
4. This is the optimum impedance for maximum power transfer over passband

### Test Circuit:

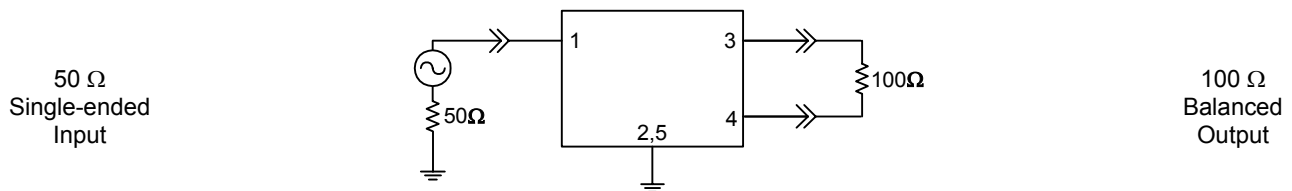

# Preliminary Data Sheet

## Electrical Specifications <sup>(1)</sup>

Operating Temperature Range: <sup>(2)</sup> -30 to +85 °C

Parameter <sup>(3)</sup>	Minimum	Typical	Maximum	Unit
<b>Center Frequency</b>	-	1575.42	-	MHz
<b>Maximum Insertion Loss</b> 1574.42 - 1576.42 MHz	-	1.4	1.7	dB
<b>Absolute Attenuation</b>				
DC - 1450 MHz	30	38	-	dB
1450 - 1475 MHz	27	31	-	dB
1475 - 1525 MHz	14	20	-	dB
1625 - 1675 MHz	10	13	-	dB
1675 - 1775 MHz	20	22	-	dB
1775 - 3155 MHz	30	35	-	dB
3155 - 6000 MHz	35	45	-	dB
<b>Input/Output Return Loss</b> 1574.42 - 1576.42 MHz	10	16	-	dB
<b>Output Amplitude Balance (<math> S_{31}/S_{21} </math>)</b> 1574.42 - 1576.42 MHz	-	0.6	1	dB
<b>Output Phase Balance <math>\phi(S_{31}) - \phi(S_{21})</math></b> 1574.42 - 1576.42 MHz	180	187.5	195	degree
<b>Nominal Source Impedance</b>	-	50	-	$\Omega$
<b>Optimal Load Impedance (balanced) <sup>(4)</sup></b>	-	120 + j35	-	$\Omega$

**Notes:**

1. All specifications are based on the test circuit shown below
2. In production, devices will be tested at room temperature to a guardbanded specification to ensure electrical compliance over temperature
3. Electrical margin has been built into the design to account for the variations due to temperature drift and manufacturing tolerances
4. This is the optimum impedance for maximum power transfer over passband

**Test Circuit:**

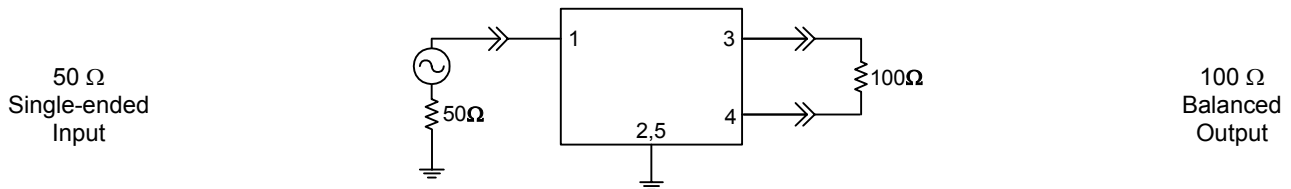

**Preliminary Data Sheet**

**Typical Performance (at +25°C)**

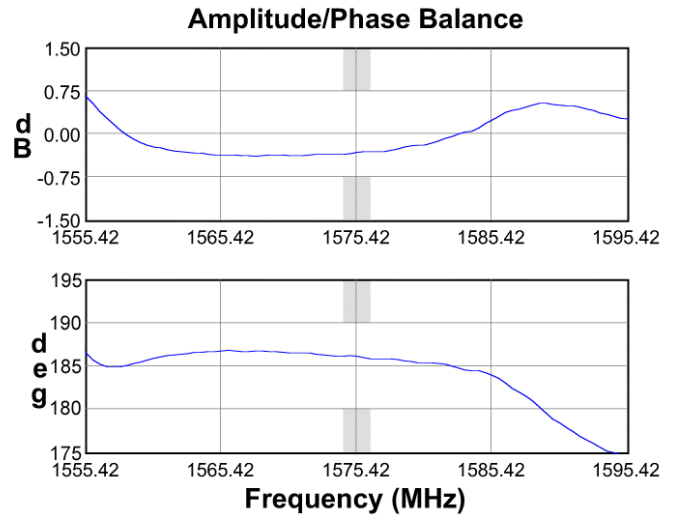
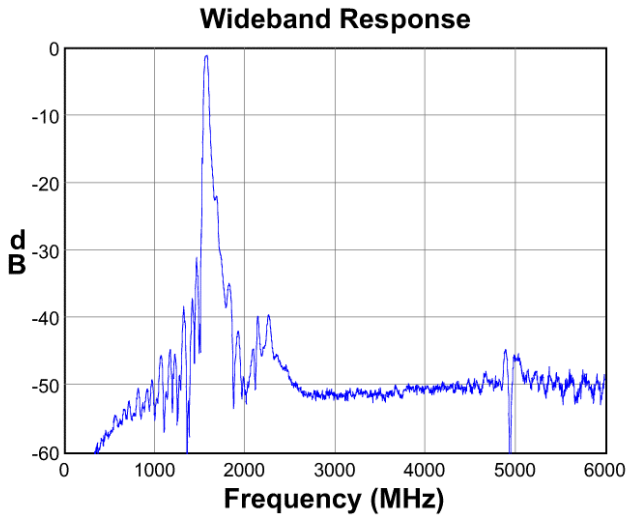
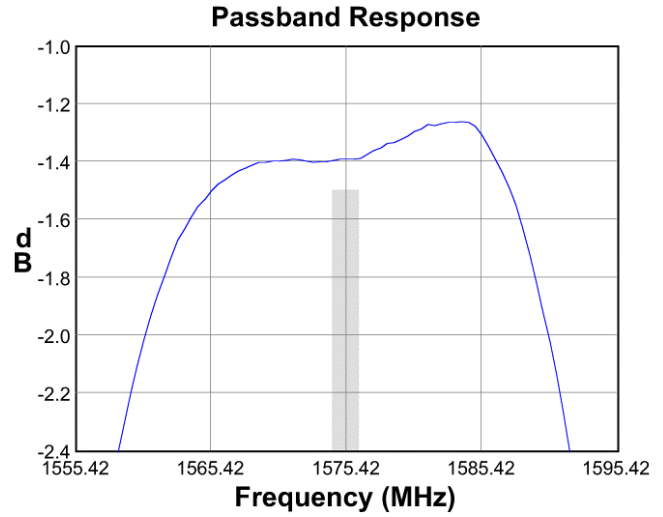
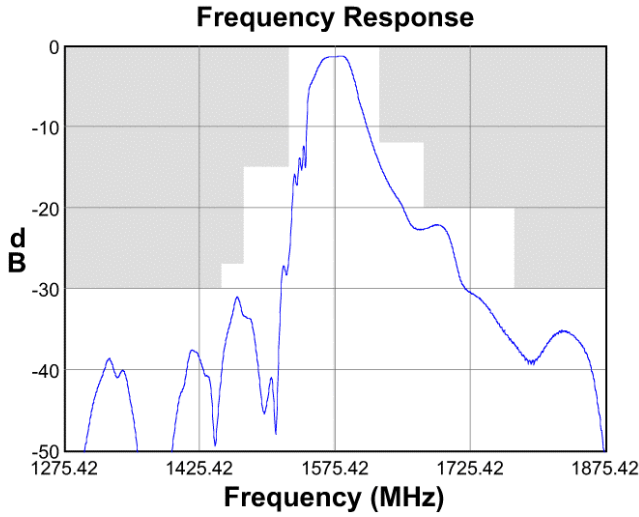

**Input Smith Chart**

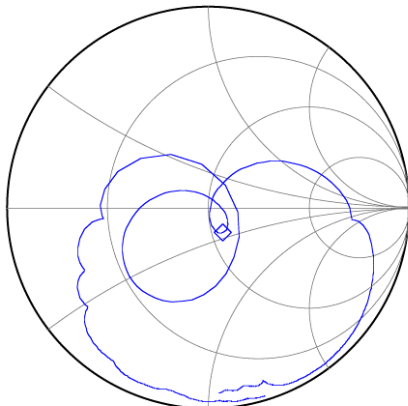

**Output Smith Chart**

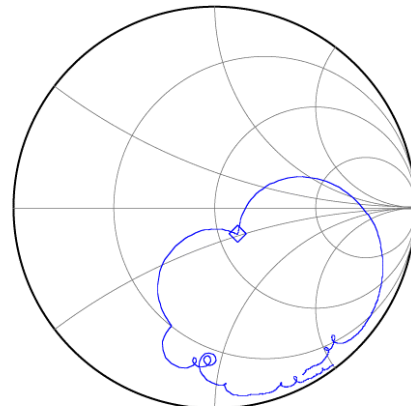

**Preliminary Data Sheet**

**Matching Schematics**

50 Ω  
Single-ended  
Input

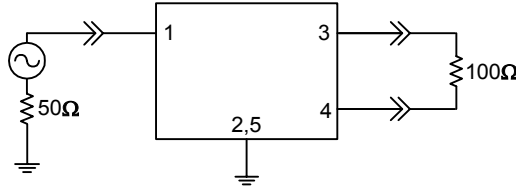

100 Ω  
Balanced  
Output

**Marking PCB Footprint**

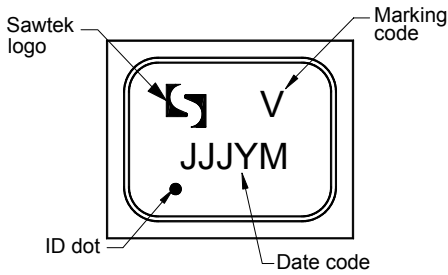

The date code consists of: JJJ = Julian day,  
Y = last digit of year, M = manufacturing site code

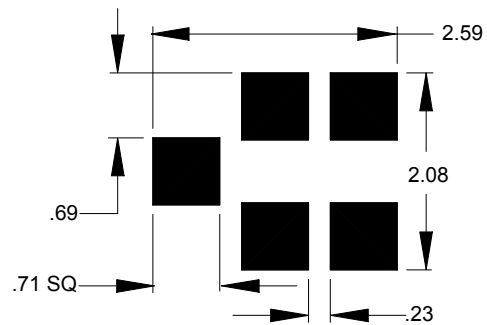

This footprint represents a recommendation only  
Dimensions shown are nominal in millimeters

**Tape and Reel**

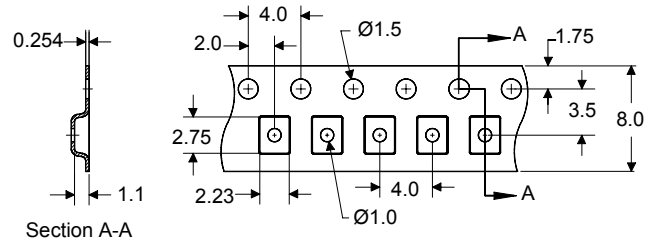
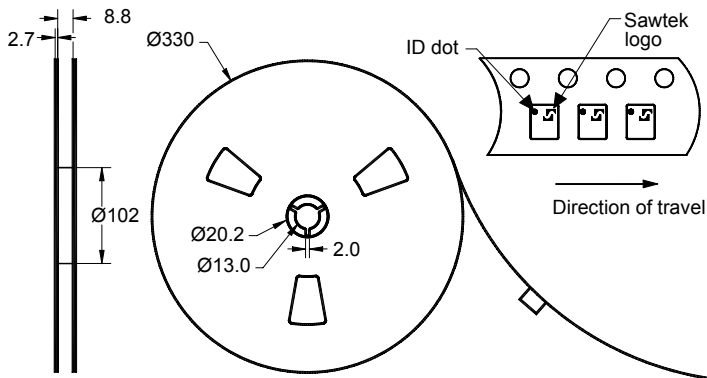

Dimensions shown are nominal in millimeters  
Packaging quantity: 10000 units/reel

# Preliminary Data Sheet

## Maximum Ratings

Parameter	Symbol	Minimum	Maximum	Unit
Operating Temperature Range	T	-30	+85	°C
Storage Temperature Range	T <sub>stg</sub>	-40	+85	°C

### Warnings

- Electrostatic Sensitive Device (ESD) 
- Avoid ultrasonic exposure

## Links to Additional Technical Information

[PCB Layout Tips](#)

[Qualification Flowchart](#)

[Soldering Profile](#)

[S-Parameters](#)

[Other Technical Information](#)

Sawtek's liability is limited only to the Surface Acoustic Wave (SAW) component(s) described in this data sheet. Sawtek does not accept any liability for applications, processes, circuits or assemblies which are implemented using any Sawtek component described in this data sheet.

## Contact Information



PO Box 609501  
Orlando, FL 32860-9501  
USA

Phone: +1 (407) 886-8860  
Fax: +1 (407) 886-7061  
Email: [custservice@sawtek.com](mailto:custservice@sawtek.com)  
Web: [www.sawtek.com](http://www.sawtek.com)

Or contact one of our worldwide  
Network of [sales offices](#),  
[Representatives or distributors](#)