

Ultra Low Dropout 1.5A Linear Regulator

General Description

The RT9183 series are high performance linear voltage regulators that provide ultra low-dropout voltage, high output current with low ground current. It operates from an input of 2.3V to 5.5V and provides output current up to 1.5A thus is suitable to drive digital circuits requiring low voltage at high currents.

The RT9183 has superior regulation over variations in line and load. Also it provides fast respond to step changes in load. Other features include over-current and over-temperature protection. The adjustable version has enable pin to reduce power consumption in shutdown mode.

The devices are available in fixed output voltages of 1.8V, 2.5V, 3.3V and as an adjustable device with a 0.8V reference voltage. The RT9183 regulators are available in 3-lead SOT-223 and TO-263 packages (fixed output only for the 3-lead option). Also available are 5-lead TO-263 and fused SOP-8 packages with two external resistors to set the output voltage ranges from 0.8V to 4.5V.

Ordering Information

RT9183 □-□□□□

Package Type

G : SOT-223

S : SOP-8

M : TO-263

M5 : TO-263-5

Operating Temperature Range

C : Commercial Standard

Output Voltage

Default : Adjustable

18 : 1.8V

25 : 2.5V

33 : 3.3V

H : Chip Enable High

L : Chip Enable Low

Features

- 330mV Dropout @ 1.5A
- 380 μ A Low Ground Pin Current
- Excellent Line and Load Regulation
- 0.1mA Quiescent Current in Shutdown Mode
- Guaranteed 1.5A Output Current
- Fixed Output Voltages: 1.8V, 2.5V, 3.3V
- Adjustable Output Voltage from 0.8V to 4.5V
- Over-Temperature/Over-Current Protection

Applications

- Battery-Powered Equipment
- Mother Board/Graphic Card
- Peripheral Cards
- PCMCIA Card

Pin Configurations

(TOP VIEW)

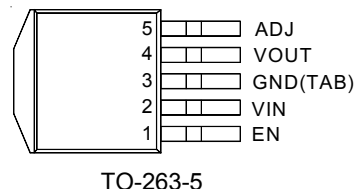
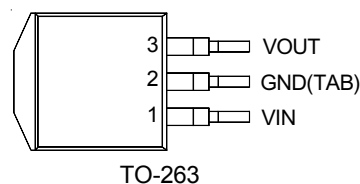
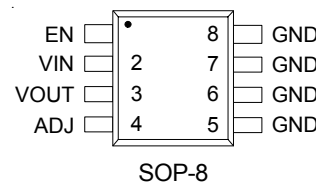
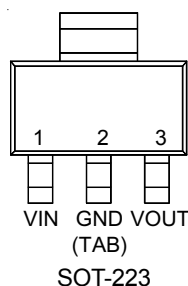

Typical Application Circuit

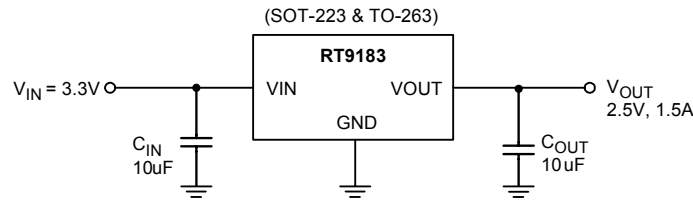
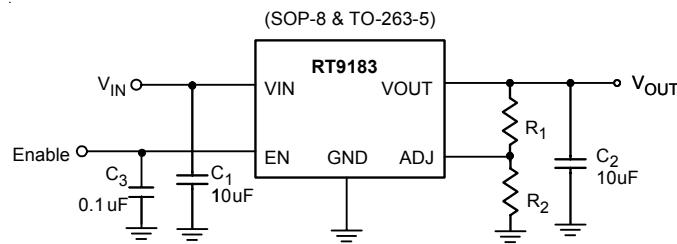

Figure 1. 3.3V to 2.5V Regulator



$$V_{OUT} = 0.8 \times \left(1 + \frac{R_1}{R_2}\right) \text{Volts}$$

Note: The value of R2 should be less than 80k to maintain regulation.

Figure 2. Adjustable Operation

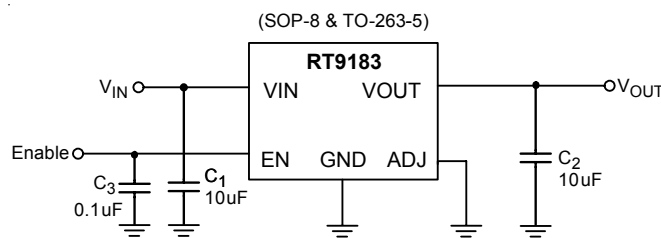
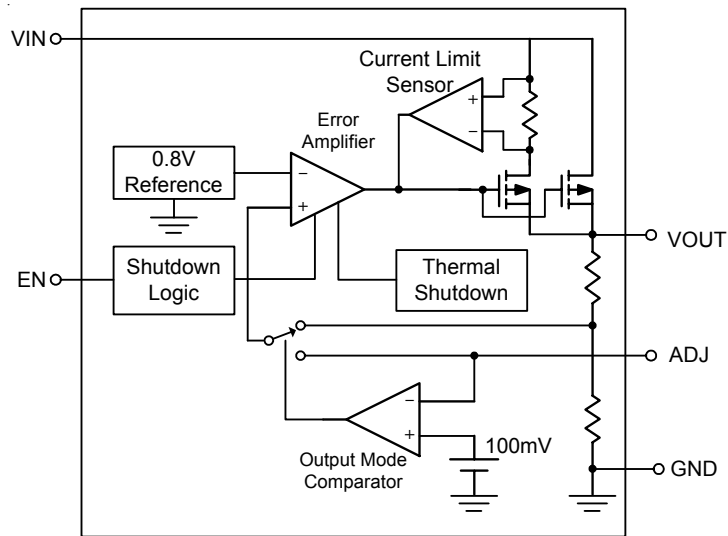

Figure 3. Fixed Operation with SOP-8 and TO-263-5 packages

Functional Pin Description

Pin Name	Pin Function
EN	Chip Enable Control Input. Note that the device will be in the unstable state if the pin is not connected.
VIN	Supply Input
GND	Common Ground
VOUT	Regulator Output
ADJ	The output voltage is set by the internal feedback resistors when this pin grounded. If external feedback resistors are applied, the output voltage will be: $V_{OUT} = 0.8 \times \left(1 + \frac{R_1}{R_2}\right) \text{Volts}$

Function Block Diagram



Absolute Maximum Ratings (Note 1)

• Supply Input Voltage	6V
• Package Thermal Resistance	
SOT-223, θ_{JC}	15°C/W
SOP-8, θ_{JC}	15.7°C/W
TO-263, θ_{JC}	8°C/W
• Lead Temperature (Soldering, 10 sec.)	260°C
• Junction Temperature	150°C
• Storage Temperature Range	-65°C to 150°C
• ESD Susceptibility (Note 2)	
HBM	2kV
MM	200V

Recommended Operating Conditions (Note 3)

• Supply Input Voltage	2.3V to 5.5V
• Junction Temperature Range	-40°C to 125°C

Electrical Characteristics

($V_{IN} = V_{OUT} + 0.7V$, $C_{IN} = C_{OUT} = 10\mu F$ (Ceramic), $T_A = 25^\circ C$ unless otherwise specified)

Parameter	Symbol	Test Conditions	Min	Typ	Max	Units	
Output Voltage Accuracy (Fixed Output Voltage)	ΔV_{OUT}	$I_{OUT} = 10mA$	-2	0	+2	%	
Output Voltage Range (Adjustable)	V_{OUT_Adj}		0.8	--	4.5	V	
Quiescent Current (Note 6)	I_Q	$I_{OUT} = 0mA$, Enable	--	380	500	μA	
Standby Current (Note 7)	I_{STBY}	$V_{IN} = 5.5V$, Shutdown	--	0.1	1	μA	
Current Limit	I_{LIM}		2	3.2	3.9	A	
Dropout Voltage (Note 4)	V_{DROP}	$I_{OUT} = 0.5A$	--	110	300	mV	
		$I_{OUT} = 1.0A$	--	220	400		
		$I_{OUT} = 1.5A$	--	330	500		
Line Regulation	ΔV_{LINE}	$V_{OUT} + 0.7V < V_{IN} < 5.5V$ $I_{OUT} = 10mA$	--	0.035	0.18	%/V	
Load Regulation (Note 5) (Fixed Output Voltage)	ΔV_{LOAD}	$1mA < I_{OUT} < 1.5A$	--	22	45	mV	
Thermal Shutdown Temperature	T_{SD}		--	170	--	°C	
Thermal Shutdown Hysteresis	ΔT_{SD}		--	30	--	°C	
EN Threshold	Logic-Low Voltage	V_{IL}	$V_{IN} = 5.5V$	--	--	0.6	V
	Logic-High Voltage	V_{IH}	$V_{IN} = 5.5V$	1.8	--	--	
Enable Pin Current	I_{EN}	$V_{IN} = 5.5V$, Enable	--	0.1	1	μA	

To be continued

Parameter	Symbol	Test Conditions	Min	Typ	Max	Units
ADJ						
Reference Voltage Tolerance	V_{REF}		0.784	0.8	0.816	V
Adjust Pin Current	I_{ADJ}	$V_{ADJ} = V_{REF}$	--	10	100	nA
Adjust Pin Threshold	$V_{TH(ADJ)}$		0.05	0.1	0.2	V

Note 1. Stresses beyond those listed under "Absolute Maximum Ratings" may cause permanent damage to the device. These are stress ratings only, and functional operation of the device at these or any other conditions beyond those indicated in the operational sections of the specifications is not implied. Exposure to absolute maximum rating conditions for extended periods may affect device reliability.

Note 2. Devices are ESD sensitive. Handling precaution recommended. The human body model is a 100pF capacitor discharged through a 1.5K Ω resistor into each pin.

Note 3. The device is not guaranteed to function outside its operating conditions.

Note 4. Dropout voltage is defined as the input to output differential at which the output voltage drops 2% below its nominal value measured at 0.7V differential.

Note 5. Regulation is measured at constant junction temperature by using a 20mS current pulse. Devices are tested for load regulation in the load range from 10mA to 1.5A.

Note 6. Quiescent, or ground current, is the difference between input and output currents. It is defined by $I_Q = I_{IN} - I_{OUT}$ under no load condition ($I_{OUT} = 0mA$). The total current drawn from the supply is the sum of the load current plus the ground pin current.

Note 7. Standby current is the input current drawn by a regulator when the output voltage is disabled by a shutdown signal ($V_{EN} > 1.8V$). It is measured with $V_{IN} = 5.5V$.

Typical Operating Characteristics

Output Voltage vs. Temperature

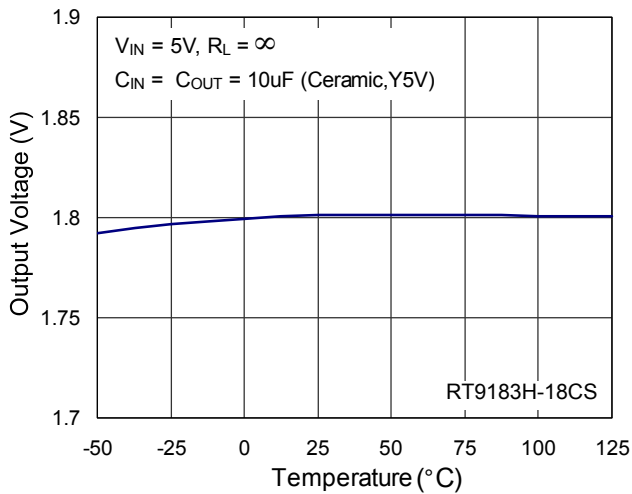

Output Voltage vs. Temperature

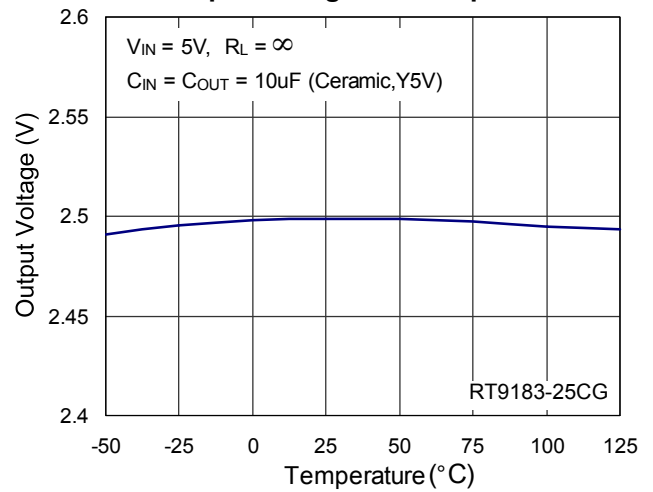

Quiescent Current vs. Temperature

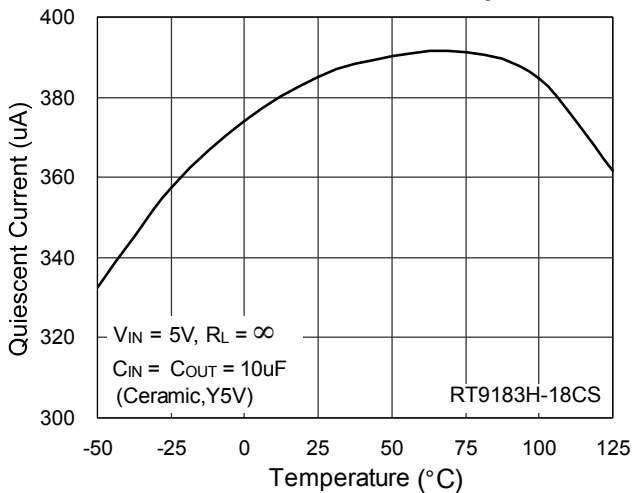

Quiescent Current vs. Temperature

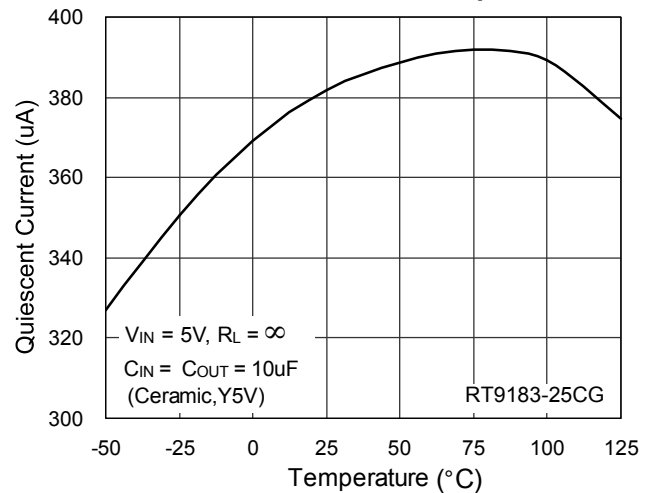

Current Limit vs. Temperature

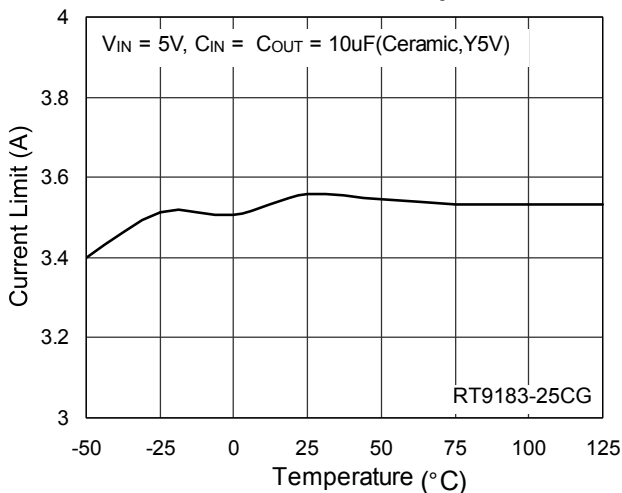

Current Limit vs. Temperature

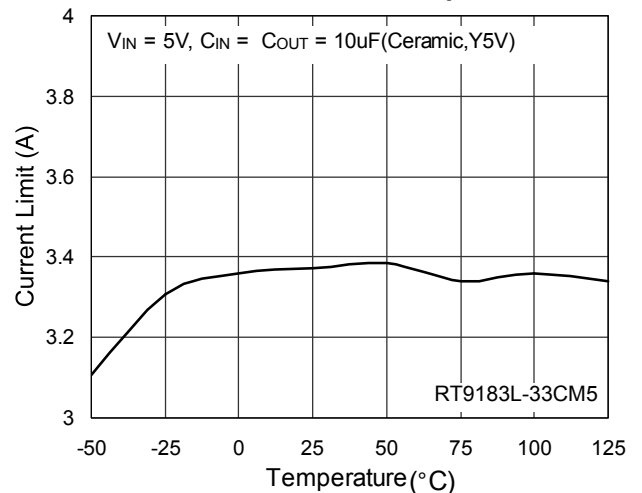

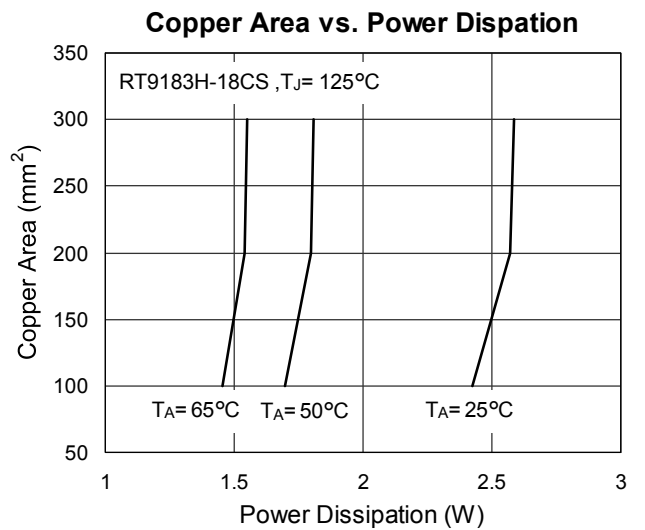
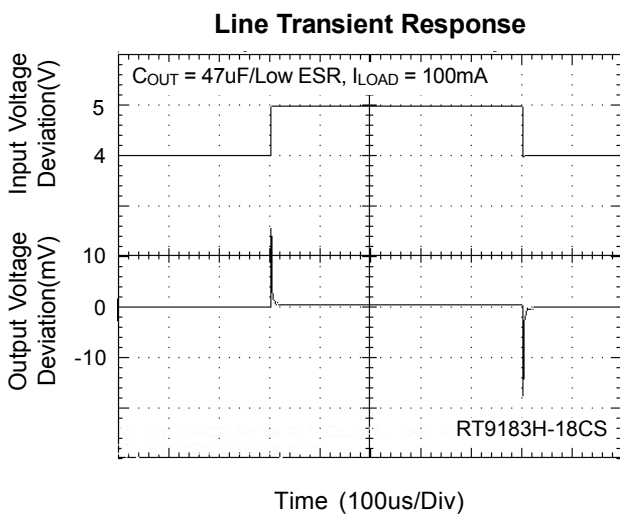
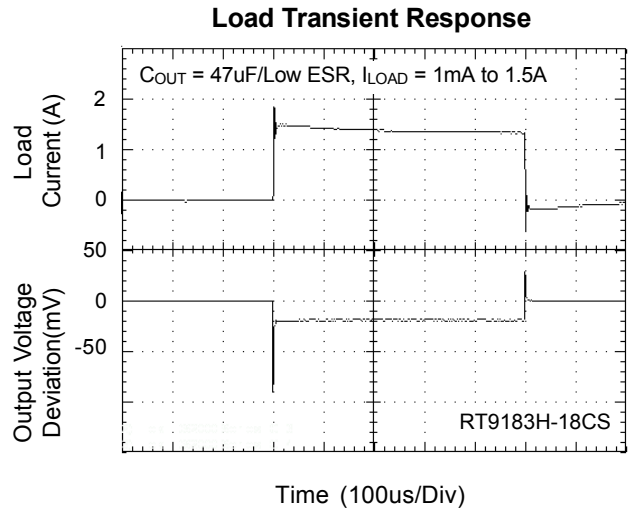
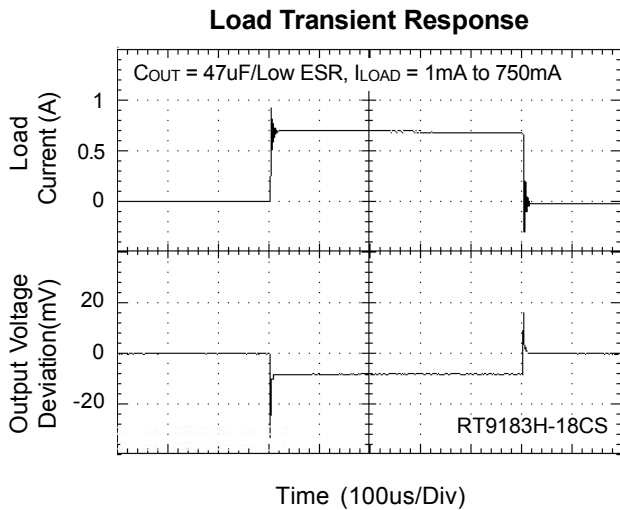
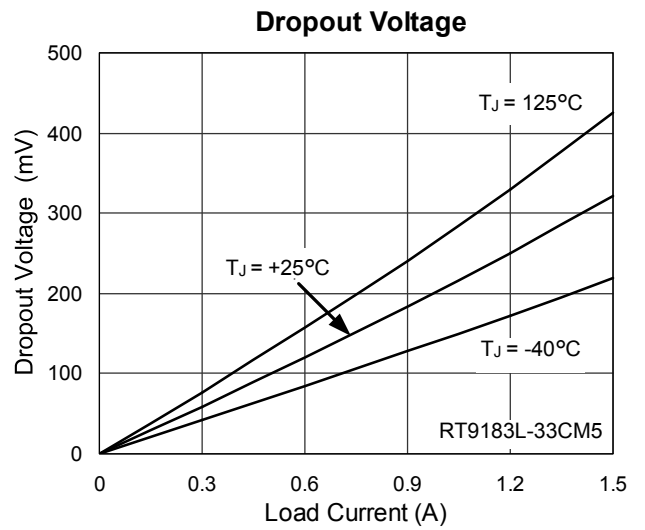
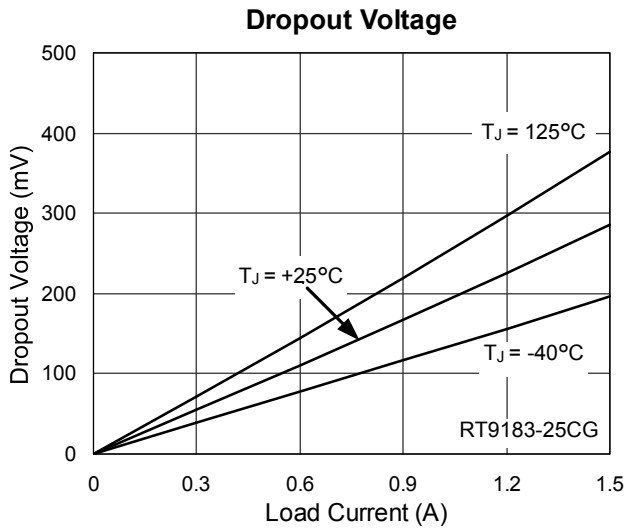

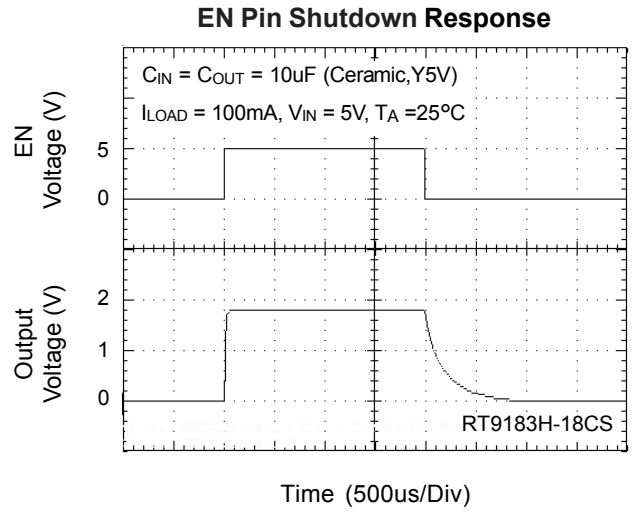
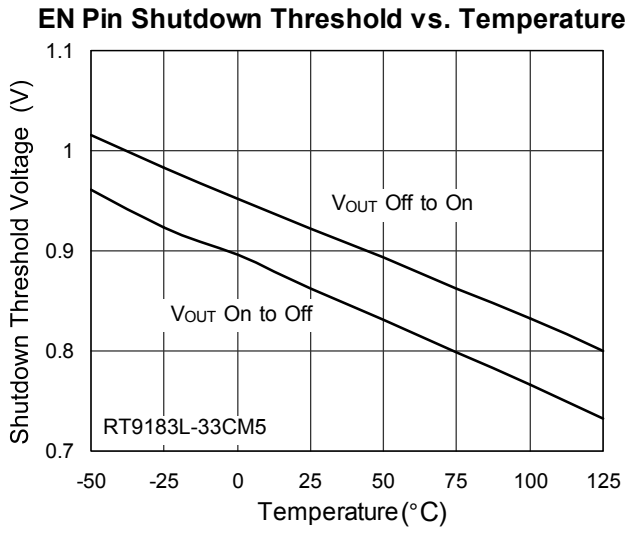

Application Information

Like any low-dropout regulator, the RT9183 series requires input and output decoupling capacitors. These capacitors must be correctly selected for good performance (see Capacitor Characteristics Section). Please note that linear regulators with a low dropout voltage have high internal loop gains which require care in guarding against oscillation caused by insufficient decoupling capacitance.

INPUT CAPACITOR

An input capacitance of $\cong 10\mu\text{F}$ is required between the device input pin and ground directly (the amount of the capacitance may be increased without limit). The input capacitor **MUST** be located less than 1 cm from the device to assure input stability (see PCB Layout Section). A lower ESR capacitor allows the use of less capacitance, while higher ESR type (like aluminum electrolytic) require more capacitance.

Capacitor types (aluminum, ceramic and tantalum) can be mixed in parallel, but the total equivalent input capacitance/ ESR must be defined as above to stable operation.

There are no requirements for the ESR on the input capacitor, but tolerance and temperature coefficient must be considered when selecting the capacitor to ensure the capacitance will be $\cong 10\mu\text{F}$ over the entire operating temperature range.

OUTPUT CAPACITOR

The RT9183 is designed specifically to work with very small ceramic output capacitors. The recommended minimum capacitance (temperature characteristics X7R or X5R) are $10\mu\text{F}$ to $47\mu\text{F}$ range with $10\text{m}\Omega$ to $25\text{m}\Omega$ range ceramic capacitors between each LDO output and GND for transient stability, but it may be increased without limit. Higher capacitance values help to improve transient.

The output capacitor's ESR is critical because it forms a zero to provide phase lead which is required for loop stability. (When using the Y5V dielectric, the minimum value of the input/output capacitance that can be used for stable over full operating temperature range is 3.3 μF .)

NO LOAD STABILITY

The device will remain stable and in regulation with no external load. This is specially important in CMOS RAM keep-alive applications.

INPUT-OUTPUT (DROPOUT) VOLTAGE

A regulator's minimum input-to-output voltage differential (dropout voltage) determines the lowest usable supply voltage. In battery-powered systems, this determines the useful end-of-life battery voltage. Because the device uses a PMOS, its dropout voltage is a function of drain-to-source on-resistance, $R_{\text{DS(ON)}}$, multiplied by the load current:

$$V_{\text{DROPOUT}} = V_{\text{IN}} - V_{\text{OUT}} = R_{\text{DS(ON)}} \times I_{\text{OUT}}$$

CURRENT LIMIT

The RT9183 monitors and controls the PMOS' gate voltage, minimum limiting the output current to 2A. The output can be shorted to ground for an indefinite period of time without damaging the part.

SHORT-CIRCUIT PROTECTION

The device is short circuit protected and in the event of a peak over-current condition, the short-circuit control loop will rapidly drive the output PMOS pass element off. Once the power pass element shuts down, the control loop will rapidly cycle the output on and off until the average power dissipation causes the thermal shutdown circuit to respond to servo the on/off cycling to a lower frequency. Please refer to the section on thermal information for power dissipation calculations.

CAPACITOR CHARACTERISTICS

It is important to note that capacitance tolerance and variation with temperature must be taken into consideration when selecting a capacitor so that the minimum required amount of capacitance is provided over the full operating temperature range. In general, a good tantalum capacitor will show very little capacitance variation with temperature, but a ceramic may not be as good (depending on dielectric type). Aluminum electrolytics also typically have large temperature variation of capacitance value.

Equally important to consider is a capacitor's ESR change with temperature: this is not an issue with ceramics, as their ESR is extremely low. However, it is very important in tantalum and aluminum electrolytic capacitors. Both show increasing ESR at colder temperatures, but the increase in aluminum electrolytic capacitors is so severe they may not be feasible for some applications.

Ceramic:

For values of capacitance in the 10 μ F to 100 μ F range, ceramics are usually larger and more costly than tantalums but give superior AC performance for by-passing high frequency noise because of very low ESR (typically less than 10m Ω). However, some dielectric types do not have good capacitance characteristics as a function of voltage and temperature.

Z5U and Y5V dielectric ceramics have capacitance that drops severely with applied voltage. A typical Z5U or Y5V capacitor can lose 60% of its rated capacitance with half of the rated voltage applied to it. The Z5U and Y5V also exhibit a severe temperature effect, losing more than 50% of nominal capacitance at high and low limits of the temperature range.

X7R and X5R dielectric ceramic capacitors are strongly recommended if ceramics are used, as they typically maintain a capacitance range within $\pm 20\%$ of nominal over full operating ratings of temperature and voltage. Of course, they are typically larger and more costly than Z5U/Y5U types for a given voltage and capacitance.

Tantalum:

Solid tantalum capacitors are recommended for use on the output because their typical ESR is very close to the ideal value required for loop compensation. They also work well as input capacitors if selected to meet the ESR requirements previously listed.

Tantalums also have good temperature stability: a good quality tantalum will typically show a capacitance value that varies less than 10~15% across the full temperature range of 125 $^{\circ}$ C to -40 $^{\circ}$ C. ESR will vary only about 2X going from the high to low temperature limits.

The increasing ESR at lower temperatures can cause oscillations when marginal quality capacitors are used (if the ESR of the capacitor is near the upper limit of the stability range at room temperature).

Aluminum:

This capacitor type offers the most capacitance for the money. The disadvantages are that they are larger in physical size, not widely available in surface mount, and have poor AC performance (especially at higher frequencies) due to higher ESR and ESL.

Compared by size, the ESR of an aluminum electrolytic is higher than either Tantalum or ceramic, and it also varies greatly with temperature. A typical aluminum electrolytic can exhibit an ESR increase of as much as 50X when going from 25 $^{\circ}$ C down to -40 $^{\circ}$ C.

It should also be noted that many aluminum electrolytics only specify impedance at a frequency of 120Hz, which indicates they have poor high frequency performance. Only aluminum electrolytics that have an impedance specified at a higher frequency (between 20kHz and 100kHz) should be used for the device. Derating must be applied to the manufacturer's ESR specification, since it is typically only valid at room temperature.

Any applications using aluminum electrolytics should be thoroughly tested at the lowest ambient operating temperature where ESR is maximum.

THERMAL CONSIDERATIONS

The RT9183 series can deliver a current of up to 1.5A over the full operating junction temperature range. However, the maximum output current must be derated at higher ambient temperature to ensure the junction temperature does not exceed 125 $^{\circ}$ C. With all possible conditions, the junction temperature must be within the range specified under operating conditions. Power dissipation can be calculated based on the output current and the voltage drop across regulator.

$$P_D = (V_{IN} - V_{OUT}) I_{OUT} + V_{IN} I_{GND}$$

The final operating junction temperature for any set of conditions can be estimated by the following thermal equation:

$$P_{D(MAX)} = (T_{J(MAX)} - T_A) / \theta_{JA}$$

Where $T_{J(MAX)}$ is the maximum junction temperature of the die (125°C) and T_A is the maximum ambient temperature. The junction to ambient thermal resistance (θ_{JA}) for SOP-8 package at recommended minimum footprint is 42°C/W, 40°C/W for SOT-223 package and 25°C/W for TO-263 package (θ_{JA} is layout dependent). Visit our website in which "Recommended Footprints for Soldering Surface Mount Packages" for detail.

PCB LAYOUT

Good board layout practices must be used or instability can be induced because of ground loops and voltage drops. The input and output capacitors **MUST** be directly connected to the input, output, and ground pins of the device using traces which have no other currents flowing through them.

The best way to do this is to layout C_{IN} and C_{OUT} near the device with short traces to the V_{IN} , V_{OUT} , and ground pins.

The regulator ground pin should be connected to the external circuit ground so that the regulator and its capacitors have a "single point ground" .

It should be noted that stability problems have been seen in applications where "vias " to an internal ground plane were used at the ground points of the device and the input and output capacitors. This was caused by varying ground potentials at these nodes resulting from current flowing through the ground plane. Using a single point ground technique for the regulator and it's capacitors fixed the problem. Since high current flows through the traces going into V_{IN} and coming from V_{OUT} , Kelvin connect the capacitor leads to these pins so there is no voltage drop in series with the input and output capacitors.

Optimum performance can only be achieved when the device is mounted on a PC board according to the diagram below:

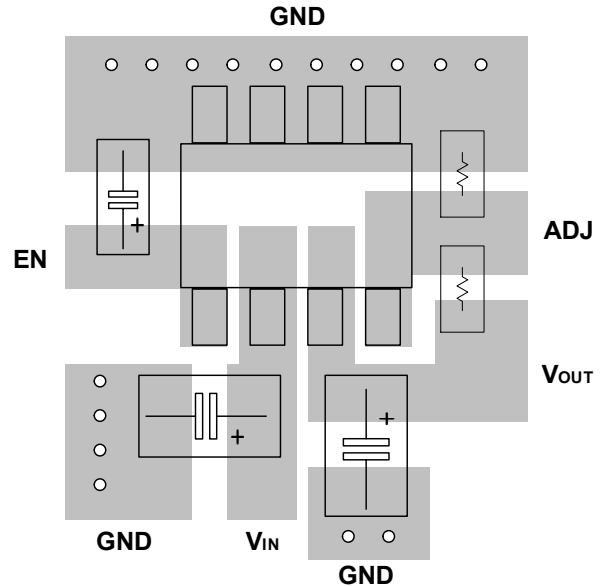

SOP-8 Board Layout

ADJUSTABLE OPERATION

The adjustable version of the RT9183 has an output voltage range of 0.8V to 4.5V. The output voltage is set by the ratio of two external resistors as shown in Figure 2. The value of R2 should be less than 80k to maintain regulation.

In critical applications, small voltage drop is caused by the resistance (R_T) of PC traces between the ground pin of the device and the return pin of R2 (See Figure 4 shown on next page). Note that the voltage drop across the external PC trace will add to the output voltage of the device.

Optimum regulation will be obtained at the point where the return pin of R2 is connected to the ground pin of the device directly.

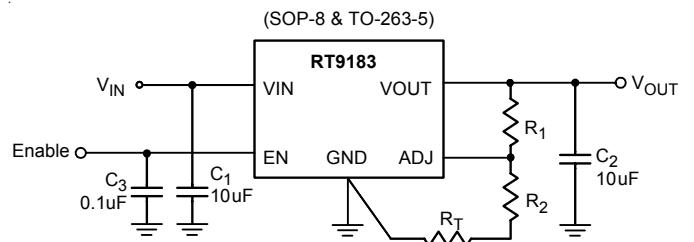
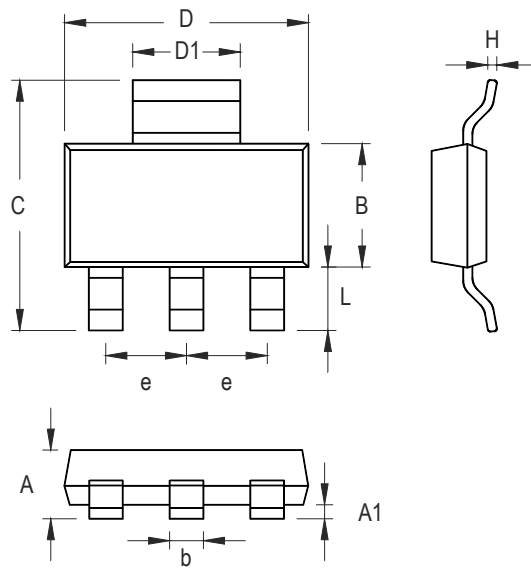

Figure 4. Return Pin of External Resistor Connection

Referring to Figure 3 the fixed voltage versions for both SOP-8 and TO-263-5 packages, the ADJ pin is the input to the error amplifier and **MUST** be tied the ground pin of the device directly otherwise it will be in the unstable state if the pin voltage more than 0.1V with respect to the ground pin itself.

Outline Dimension



Symbol	Dimensions In Millimeters		Dimensions In Inches	
	Min	Max	Min	Max
A	--	1.803	--	0.071
A1	0.020	0.100	0.0008	0.0047
b	0.610	0.787	0.024	0.031
B	3.302	3.708	0.130	0.146
C	6.706	7.290	0.264	0.287
D	6.299	6.706	0.248	0.264
D1	2.896	3.150	0.114	0.124
e	2.261	2.362	0.089	0.093
H	0.229	0.330	0.009	0.013
L	0.914	--	0.036	--

3-Lead SOT-223 Plastic Surface Mount

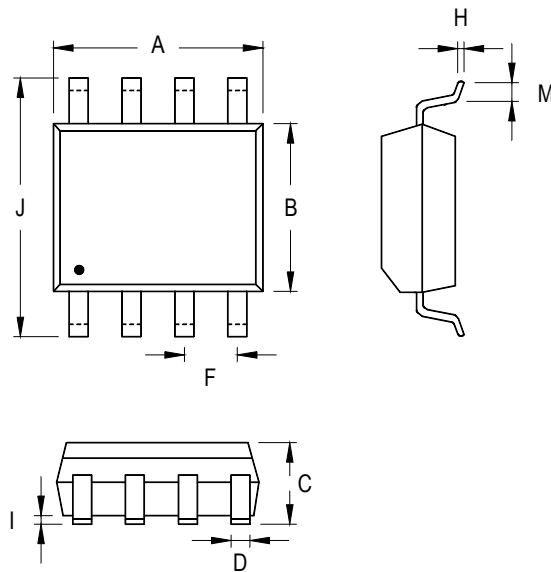

Symbol	Dimensions In		Dimensions In Inches	
	Min	Max	Min	Max
A	4.801	5.004	0.189	0.197
B	3.810	3.988	0.150	0.157
C	1.346	1.753	0.053	0.069
D	0.330	0.508	0.013	0.020
F	1.194	1.346	0.047	0.053
H	0.178	0.254	0.007	0.010
I	0.102	0.254	0.004	0.010
J	5.791	6.198	0.228	0.244
M	0.406	1.270	0.016	0.050

8-Lead SOP Plastic Package

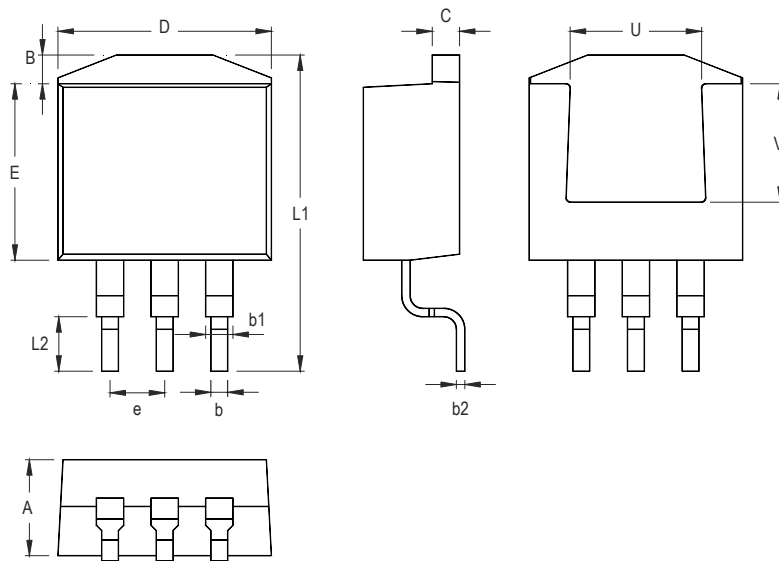

Symbol	Dimensions In Millimeters		Dimensions In Inches	
	Min	Max	Min	Max
A	4.064	4.826	0.160	0.190
B	1.143	1.676	0.045	0.066
b	0.660	0.914	0.026	0.036
b1	1.143	1.397	0.045	0.055
b2	0.305	0.584	0.012	0.023
C	1.143	1.397	0.045	0.055
D	9.652	10.668	0.380	0.420
E	8.128	9.652	0.320	0.380
e	2.286	2.794	0.090	0.110
L1	14.605	15.875	0.575	0.625
L2	2.286	2.794	0.090	0.110
U	6.223 Ref.		0.245 Ref.	
V	7.620 Ref.		0.300 Ref.	

3-Lead TO- 263 Surface Mount

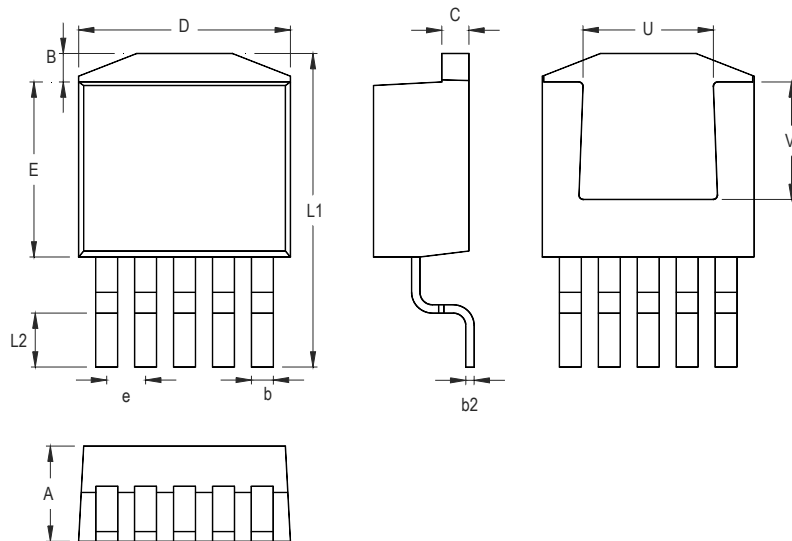

Symbol	Dimensions In Millimeters		Dimensions In Inches	
	Min	Max	Min	Max
A	4.064	4.826	0.160	0.190
B	1.143	1.676	0.045	0.066
b	0.660	0.914	0.026	0.036
b2	0.305	0.584	0.012	0.023
C	1.143	1.397	0.045	0.055
D	9.652	10.668	0.380	0.420
E	8.128	9.652	0.320	0.380
e	1.524	1.829	0.060	0.072
L1	14.605	15.875	0.575	0.625
L2	2.286	2.794	0.090	0.110
U	6.223 Ref.		0.245 Ref.	
V	7.620 Ref.		0.300 Ref.	

5-Lead TO-263 Plastic Surface Mount Package

RICHTEK TECHNOLOGY CORP.

Headquarter
 5F, No. 20, Taiyuen Street, Chupei City
 Hsinchu, Taiwan, R.O.C.
 Tel: (8863)5526789 Fax: (8863)5526611

RICHTEK TECHNOLOGY CORP.

Taipei Office (Marketing)
 8F-1, No. 137, Lane 235, Paochiao Road, Hsintien City
 Taipei County, Taiwan, R.O.C.
 Tel: (8862)89191466 Fax: (8862)89191465
 Email: marketing@richtek.com