

# Integrated PAL and PAL/NTSC TV processors

## TDA8360; TDA8361; TDA8362

### FEATURES

#### Available in TDA8360, TDA8361 and TDA8362

- Vision IF amplifier with high sensitivity and good differential gain and phase
- Multistandard FM sound demodulator (4.5 MHz to 6.5 MHz)
- Integrated chrominance trap and bandpass filters (automatically calibrated)
- Integrated luminance delay line
- RGB control circuit with linear RGB inputs and fast blanking
- Horizontal synchronization with two control loops and alignment-free horizontal oscillator without external components
- Vertical count-down circuit (50/60 Hz) and vertical preamplifier
- Low dissipation (700 mW)
- Small amount of peripheral components compared with competition ICs
- Only one adjustment (vision IF demodulator)
- The supply voltage for the ICs is 8 V. They are mounted in a shrink DIL envelope with 52 pins and are pin compatible.

### Additional features

#### TDA8360

- Alignment-free PAL colour decoder for all PAL standards, including PAL-N and PAL-M.

#### TDA8361

- PAL/NTSC colour decoder with automatic search system
- Source selection for external audio/video (A/V) inputs (separate Y/C signals can also be applied).

#### TDA8362

- Multistandard vision IF circuit (positive and negative modulation)
- PAL/NTSC colour decoder with automatic search system
- Source selection for external A/V inputs (separate Y/C signals can also be applied)
- Easy interfacing with the TDA8395 (SECAM decoder) for multistandard applications.

### GENERAL DESCRIPTION

The TDA8360, TDA8361 and TDA8362 are single-chip TV processors which contain nearly all small signal functions that are required for a colour television receiver. For a complete receiver the following circuits need to be added: a base-band delay line (TDA4661), a tuner and output stages for audio, video and horizontal and vertical deflection.

Because of the different functional contents of the ICs the set maker can make the optimum choice depending on the requirements for the receiver.

The TDA8360 is intended for simple PAL receivers (all PAL standards, including PAL-N and PAL-M are possible).

The TDA8361 contains a PAL/NTSC decoder and has an A/V switch.

For real multistandard applications the TDA8362 is available. In addition to the extra functions which are available in the TDA8361, the TDA8362 can handle signals with positive modulation and it supplies the signals which are required for the SECAM decoder TDA8395.

### ORDERING INFORMATION

EXTENDED TYPE NUMBER	PACKAGE			
	PINS	PIN POSITION	MATERIAL	CODE
TDA8360	52	shrink DIL	plastic	SOT247AG
TDA8361	52	shrink DIL	plastic	SOT247AG
TDA8362	52	shrink DIL	plastic	SOT247AG

# Integrated PAL and PAL/NTSC TV processors

TDA8360; TDA8361; TDA8362

**QUICK REFERENCE DATA**

SYMBOL	PARAMETER	CONDITIONS	MIN.	TYP.	MAX.	UNIT
$V_P$	supply voltage		7.2	8.0	8.8	V
$I_P$	supply current		–	80	–	mA
<b>Input voltages</b>						
$V_{45,46(rms)}$	video IF amplifier sensitivity (RMS value)		–	70	100	$\mu$ V
$V_{5(rms)}$	sound IF amplifier sensitivity (RMS value)		–	1	–	mV
$V_{6(rms)}$	external audio input (RMS value)	TDA8361, TDA8362	–	350	–	mV
$V_{15(p-p)}$	external CVBS input (peak-to-peak value)	TDA8361, TDA8362	–	1	–	V
$V_{22,23,24(p-p)}$	RGB inputs (peak-to-peak value)		–	0.7	–	V
<b>Output signals</b>						
$V_{O(p-p)}$	demodulated CVBS output (peak-to-peak value)		–	2.4	–	V
$I_{47}$	tuner AGC control current		0	–	5	mA
$V_{44}$	AFC output voltage swing		–	6	–	V
$V_{50(rms)}$	audio output voltage (RMS value)		–	700	–	mV
$V_{18,19,20(p-p)}$	RGB output signal amplitudes (peak-to-peak value)		–	4	–	V
$I_{37}$	horizontal output current		10	–	–	mA
$I_{43}$	vertical output current		1	–	–	mA
<b>Control voltages</b>						
$V_{control}$	control voltages for Volume, Contrast, Saturation, Brightness, Hue and Peaking		0	–	5	V

Integrated PAL and PAL/NTSC TV processors

TDA8360; TDA8361; TDA8362

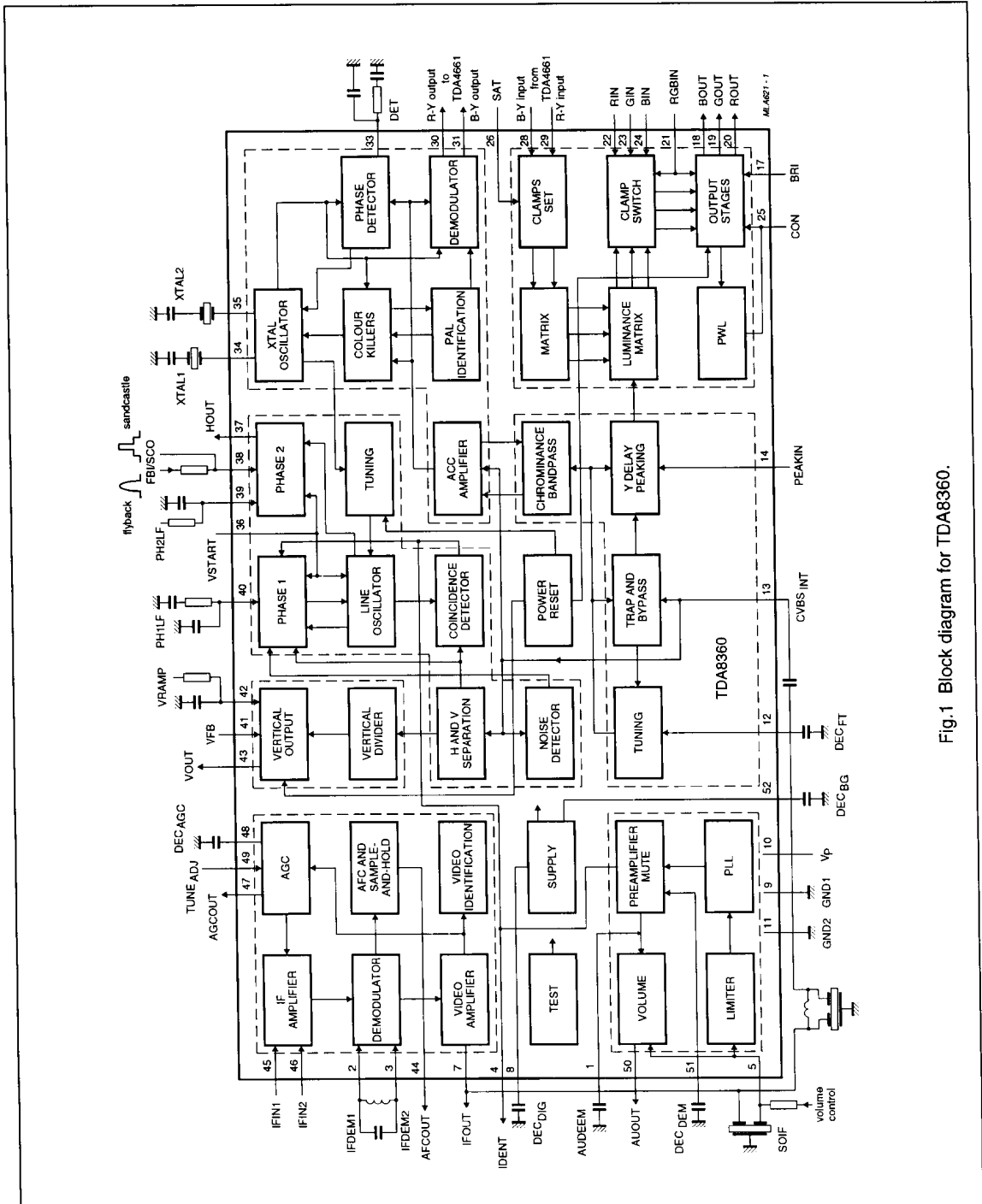

Fig. 1 Block diagram for TDA8360.

# Integrated PAL and PAL/NTSC TV processors

## TDA8360; TDA8361; TDA8362

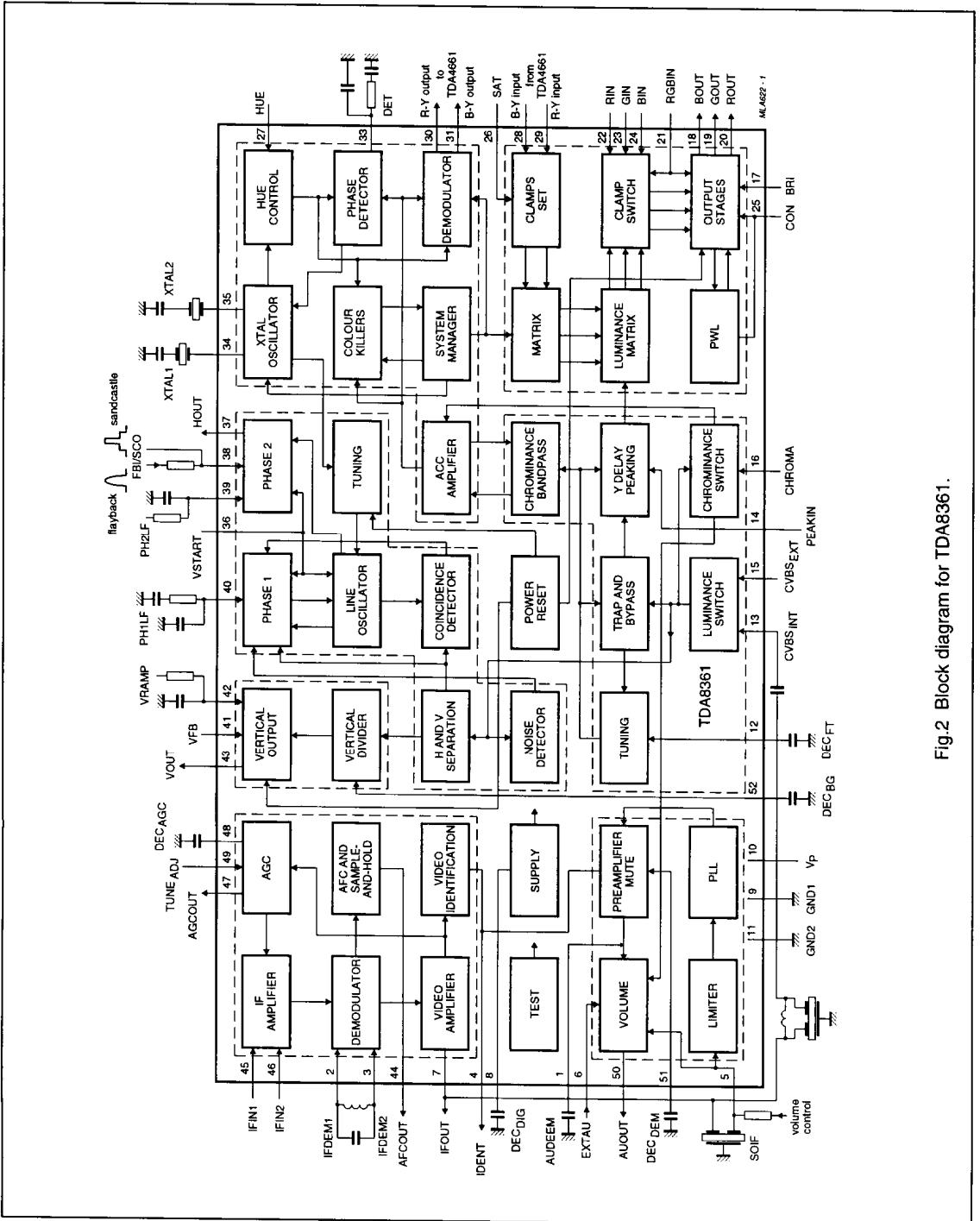

Fig. 2 Block diagram for TDA8361.

# Integrated PAL and PAL/NTSC TV processors

## TDA8360; TDA8361; TDA8362

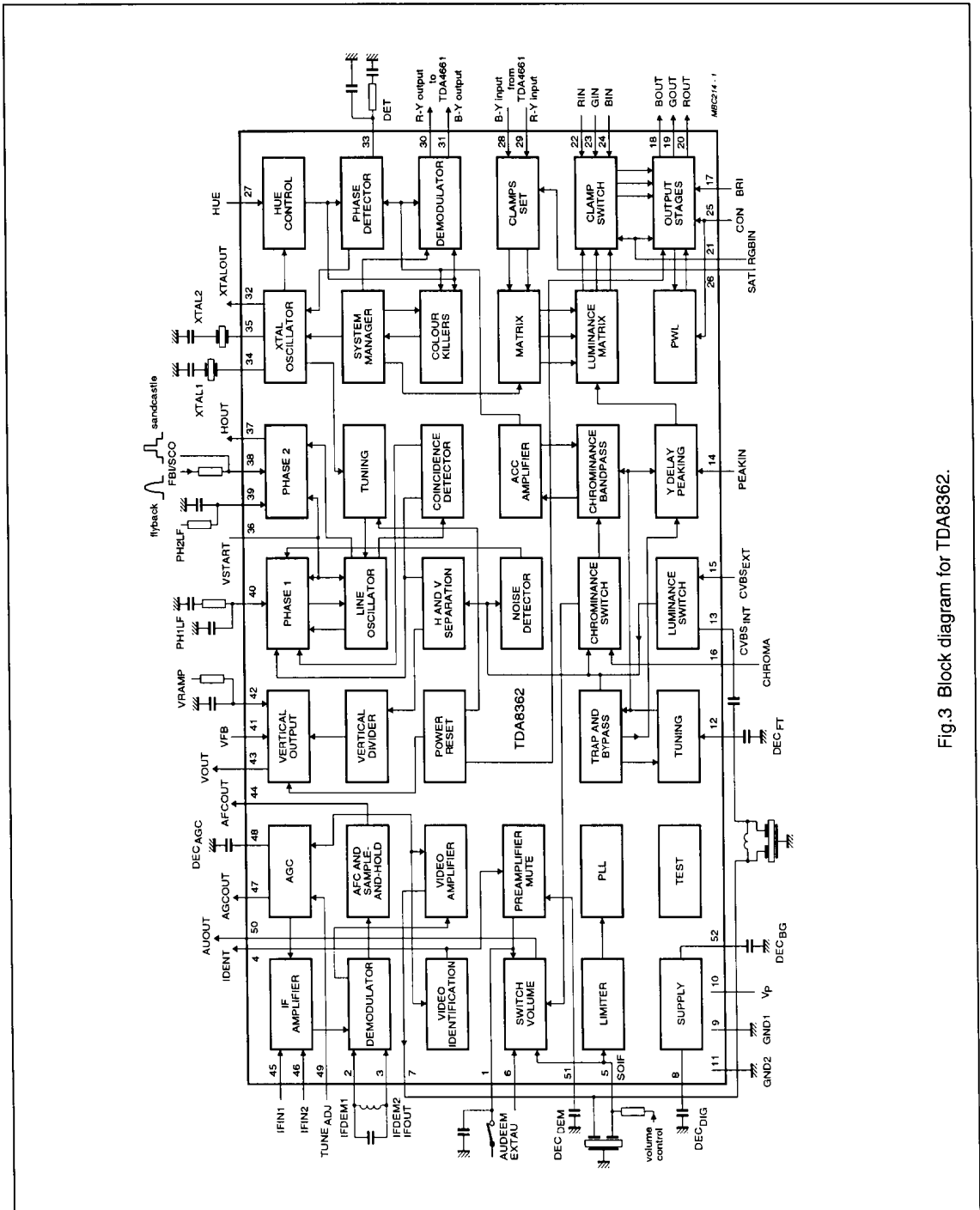
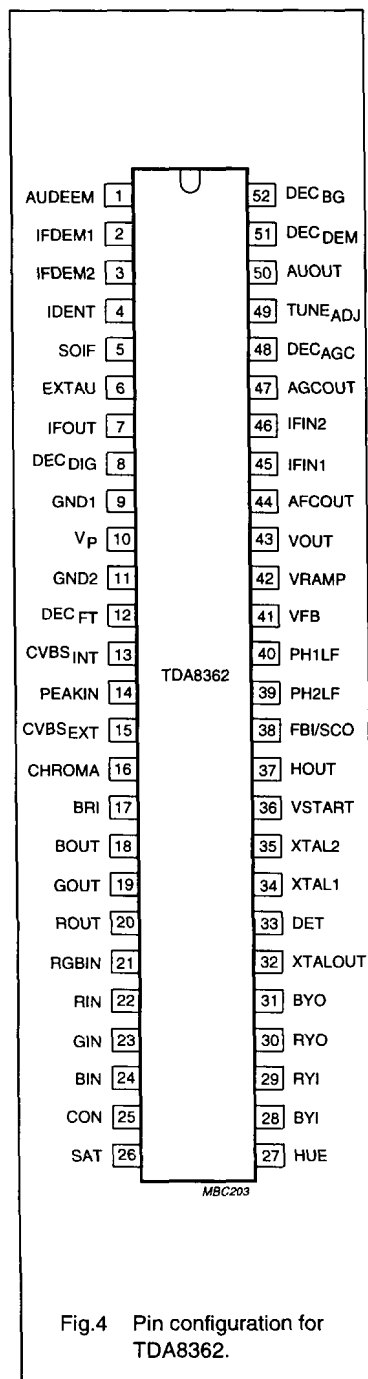

Fig. 3 Block diagram for TDA8362.

# Integrated PAL and PAL/NTSC TV processors

## TDA8360; TDA8361; TDA8362

### PINNING (TDA8362)



SYMBOL	PIN	DESCRIPTION
AUDEEM	1	audio de-emphasis and $\pm$ modulation switch
IFDEM1	2	IF demodulator tuned circuit
IFDEM2	3	IF demodulator tuned circuit
IDENT	4	video identification output/MUTE input
SOIF	5	sound IF input and volume control
EXTAU	6	external audio input
IFOUT	7	IF video output
DEC <sub>DIG</sub>	8	decoupling digital supply
GND1	9	ground 1
V <sub>P</sub>	10	supply voltage (+8 V)
GND2	11	ground 2
DEC <sub>FT</sub>	12	decoupling filter tuning
CVBS <sub>INT</sub>	13	internal CVBS input
PEAKIN	14	peaking control input
CVBS <sub>EXT</sub>	15	external CVBS input
CHROMA	16	chrominance and A/V switch input
BRI	17	brightness control input
BOUT	18	blue output
GOUT	19	green output
ROUT	20	red output
RGBIN	21	RGB insertion and blanking input
RIN	22	red input
GIN	23	green input
BIN	24	blue input
CON	25	contrast control input
SAT	26	saturation control input
HUE	27	hue control input (or chrominance output)
BYI	28	B-Y input signal
RYI	29	R-Y input signal
RYO	30	R-Y output signal
BYO	31	B-Y output signal
XTALOUT	32	4.43 MHz output for TDA8395
DET	33	loop filter burst phase detector
XTAL1	34	3.58 MHz crystal connection
XTAL2	35	4.43 MHz crystal connection
VSTART	36	supply/start horizontal oscillator
HOUT	37	horizontal output
FBI/SCO	38	flyback input/sandcastle output
PH2LF	39	phase 2 loop filter
PH1LF	40	phase 1 loop filter

# Integrated PAL and PAL/NTSC TV processors

TDA8360; TDA8361; TDA8362

SYMBOL	PIN	DESCRIPTION
VFB	41	vertical feedback input
VRAMP	42	vertical ramp generator
VOUT	43	vertical output
AFCOUT	44	AFC output
IFIN1	45	IF input 1
IFIN2	46	IF input 2
AGCOUT	47	tuner AGC output
DEC <sub>AGC</sub>	48	AGC decoupling capacitor
TUNE <sub>ADJ</sub>	49	tuner take-over adjustment
AUOUT	50	audio output
DEC <sub>DEM</sub>	51	decoupling sound demodulator
DEC <sub>BG</sub>	52	decoupling bandgap supply

To overcome this problem a speed-up circuit has been included which detects whether the AGC detector is activated every frame period. If, during a 3-frame period, no action is detected the speed of the system is increased. When the incoming signal has no peak white information (e.g. test lines in the vertical retrace period) the gain would be video signal dependent. To avoid this effect the circuit also contains a black level AGC detector which is activated when the black level of the video signal exceeds a certain level.

The TDA8361 and TDA8362 contain a video identification circuit which is independent of the synchronization circuit. Therefore search tuning is possible when the display section of the receiver is used as a monitor. In the TDA8360 this circuit is only used for stable OSD at no signal input. In the normal television mode the identification output is connected to the coincidence detector, this applies to all three devices. The identification output voltage is LOW when no transmitter is identified. In this condition the sound demodulator is switched off (mute function). When a transmitter is identified the output voltage is HIGH. The voltage level is dependent on the frequency of the incoming chrominance signal.

## TDA8360

The TDA8360 has the following differences to the pinning:

Pin 6: external audio input not connected

Pin 15: external CVBS input not connected

Pin 16: chrominance and A/V switch input not connected

Pin 27: hue control input not connected.

## TDA8361

The TDA8361 has the following differences to the pinning:

Pin 1: only audio de-emphasis

Pin 27: only hue control

Pin 32: 4.43 MHz output for TDA8395 is not connected.

## FUNCTIONAL DESCRIPTION

### Video IF amplifier

The IF amplifier contains 3 AC-coupled control stages with a total gain control range of greater than 60 dB. The sensitivity of the circuit is comparable with that of modern IF ICs.

The reference carrier for the video demodulator is obtained by means of passive regeneration of the picture carrier. The external reference tuned circuit is the only remaining adjustment of the IC.

In the TDA8362 the polarity of the demodulator can be switched so that the circuit is suitable for both positive and negative modulated signals.

The AFC circuit is driven with the same reference signal as the video demodulator. To ensure that the video content does not disturb the AFC operation a sample-and-hold circuit is incorporated; the capacitor for this function is internal. The AFC output voltage is 6 V.

The AGC detector operates on levels, top sync for negative modulated and top white for positive modulated signals. The AGC detector time constant capacitor is connected externally. This is mainly because of the flexibility of the application.

The time constant of the AGC system during positive modulation (TDA8362) is slow, this is to avoid any visible picture variations. This, however, causes the system to react very slowly to sudden changes in the input signal amplitude.

## Integrated PAL and PAL/NTSC TV processors

TDA8360; TDA8361; TDA8362

### Sound circuit

The sound bandpass and trap filters have to be connected externally. The filtered intercarrier signal is fed to a limiter circuit and is demodulated by means of a PLL demodulator. The PLL circuit tunes itself automatically to the incoming signal, consequently, no adjustment is required.

The volume is DC controlled. The composite audio output signal has an amplitude of 700 mV RMS at a volume control setting of -6 dB. The de-emphasis capacitor has to be connected externally. The non-controlled audio signal can be obtained from this pin via a buffer stage. The amplitude of this signal is 350 mV RMS.

The TDA8361 and TDA8362 external audio input signal must have an amplitude of 350 mV RMS. The audio/video switch is controlled via the chrominance input pin.

### Synchronization circuit

The sync separator is preceded by a voltage controlled amplifier which adjusts the sync pulse amplitude to a fixed level. The sync pulses are then fed to the slicing stage (separator) which operates at 50% of the amplitude.

The separated sync pulses are fed to the first phase detector and to the coincidence detector. The coincidence detector is used for transmitter identification and to detect whether the line oscillator is synchronized. When the circuit is not synchronized the voltage on the peaking control pin (pin 14) is LOW so that this condition can be detected externally. The first PLL has a very high static steepness, this ensures that the phase of the picture is independent of the line frequency. The line oscillator operates at twice the line frequency.

The oscillator network is internal. Because of the spread of internal components an automatic adjustment circuit has been added to the IC. The circuit compares the oscillator frequency with that of the crystal oscillator in the colour decoder. This results in a free-running frequency which deviates less than 2% from the typical value.

The circuit employs a second control loop to generate the drive pulses for the horizontal driver stage.

X-ray protection can be realised by switching the pin of the second control loop to the positive supply line. The detection circuit must be connected externally. When the X-ray protection is active the horizontal output voltage is switched to a high level. When the voltage on this pin returns to its normal level the horizontal output is released again.

The IC contains a start-up circuit for the horizontal oscillator. When this feature is required a current of 6.5 mA has to be supplied to pin 36. For an application without start-up both supply pins (10 and 36) must be connected to the 8 V supply line.

The drive signal for the vertical ramp generator is generated by means of a divider circuit. The RC network for the ramp generator is external.

### Integrated video filters

The circuit contains a chrominance bandpass and trap circuit. The filters are realised by means of gyrator circuits and are automatically tuned by comparing the tuning frequency with the crystal frequency of the decoder.

In the TDA8361 and TDA8362 the chrominance trap is active only when the separate chrominance input pin is connected to ground or to the positive supply voltage and when a colour signal is recognized.

When the pin is left open-circuit the trap is switched off so that the circuit can also be used for S-VHS applications.

The luminance delay line and the delay for the peaking circuit are also realised by means of gyrator circuits.

### Colour decoder

The colour decoder in the various ICs contains an alignment-free crystal oscillator, a colour killer circuit and colour difference demodulators. The 90° phase shift for the reference signal is achieved internally. Because the main differences of the 3 ICs are found in the colour decoder the various types will be discussed.

### TDA8360

This IC contains only a PAL decoder. Depending on the frequency of the crystals which are connected to the IC the decoder can demodulate all PAL standards. Because the horizontal oscillator is calibrated by using the crystal frequency as a reference the 4.4 MHz crystal must be connected to pin 35 and the 3.5 MHz crystal to pin 34. When only one crystal is connected to the IC the other crystal pin must be connected to the positive supply rail via a 47 kΩ resistor. For applications with two 3.5 MHz crystals both must be connected to pin 34 and the switching between the crystals must be made externally. Switching of the crystals is only allowed directly after the vertical retrace. The circuit will indicate whether a PAL signal has been identified by the colour decoder via the saturation control pin.

When two crystals are connected to the IC the output voltage of the video identification circuit indicates the frequency of the incoming chrominance signal.



## Integrated PAL and PAL/NTSC TV processors

TDA8360; TDA8361; TDA8362

The conditions are:

- Signal identified at  
 $f_{osc} = 3.6 \text{ MHz}$ ;  $V_O = 6 \text{ V}$
- Signal identified at  
 $f_{osc} = 4.4 \text{ MHz}$  (or no colour);  
 $V_O = 8 \text{ V}$ .

This information can be used to switch the sound bandpass filter and trap filter.

### TDA8361

This IC contains an automatic PAL/NTSC decoder. The conditions for connecting the reference crystals are the same as for the TDA8360. The decoder can be forced to PAL when the hue control pin is connected to the positive supply voltage via a 5 k $\Omega$  or 10 k $\Omega$  resistor (approximately). The decoder cannot be forced to the NTSC standard. It is also possible to see if a colour signal is recognized via the saturation pin.

### TDA8362

In addition to the possibilities of the TDA8361, the TDA8362 can co-operate with the SECAM add-on decoder TDA8395. The communication between the two ICs is achieved via pin 32. The TDA8362 supplies the reference signal (4.43 MHz) for the calibration system of the TDA8395, identification of the colour standard is via the same connection. When a SECAM signal is detected by the TDA8395 the IC will draw a current of 150  $\mu\text{A}$ . When TDA8362 has not identified a colour signal in this condition it will go into the SECAM mode, that means it will switch off the R–Y and B–Y outputs and increase the voltage level on pin 32.

This voltage will switch off the colour-killer in the TDA8395 and switch on the R–Y and B–Y outputs of the TDA8395. Forcing the system to the SECAM standard can be achieved by loading pin 32 with a current of 150  $\mu\text{A}$ . Then the system manager in the TDA8362 will not search for PAL or NTSC signals. Forcing to NTSC is not possible. For PAL/SECAM applications the input signal for the TDA8395 can be obtained from pin 27 (hue control) when this pin is connected to the positive supply rail via the 5 k $\Omega$  or 10 k $\Omega$  resistor. An external source selector is required by the TDA8395/TDA8362 combination for PAL/SECAM/NTSC applications.

### RGB output circuit

The colour difference signals are matrixed with the luminance signal to obtain the RGB signals. Linear amplifiers have been chosen for the RGB inputs so that the circuit is suitable for incoming signals from the SCART connector. The contrast and brightness controls operate on internal and external signals.

The fast blanking pin has a second detection level at 3.5 V. When this level is exceeded the RGB outputs are blanked so that "On-Screen-Display" signals can be applied to the outputs. The output signal has an amplitude of approximately 4 V, black-to-white, with nominal input signals and nominal control settings. The nominal black level is 1.3 V.

# Integrated PAL and PAL/NTSC TV processors

TDA8360; TDA8361; TDA8362

## LIMITING VALUES

In accordance with the Absolute Maximum Rating System (IEC134).

SYMBOL	PARAMETER	MIN.	MAX.	UNIT
$V_P$	supply voltage	–	9.0	V
$T_{stg}$	storage temperature	–25	+150	°C
$T_{amb}$	operating ambient temperature	–25	+70	°C
$T_{sol}$	soldering temperature for 5 s	–	260	°C
$T_j$	maximum junction temperature (operating)	–	150	°C

## THERMAL RESISTANCE

SYMBOL	PARAMETER	THERMAL RESISTANCE
$R_{th\ j-a}$	from junction to ambient in free air	40 K/W

## CHARACTERISTICS

 $V_P = 8\text{ V}$ ;  $T_{amb} = 25\text{ °C}$ ; unless otherwise specified.

SYMBOL	PARAMETER	CONDITIONS	MIN.	TYP.	MAX.	UNIT
<b>Supplies</b>						
$V_P$	supply voltage (pin 10)		7.2	8.0	8.8	V
$I_P$	supply current (pin 10)		–	80	–	mA
$I_{HOSC}$	horizontal oscillator start current (pin 36)	note 1	6.5	–	–	mA
$P_{tot}$	total power dissipation	including start supply	–	0.7	–	W
<b>IF circuit</b>						
VISION IF AMPLIFIER INPUTS (PINS 45 AND 46)						
$V_{i(rms)}$	input sensitivity (RMS value)	note 2 $f_i = 38.90\text{ MHz}$ $f_i = 45.75\text{ MHz}$ $f_i = 58.75\text{ MHz}$	–	70	100	$\mu\text{V}$
$R_i$	Input resistance (differential)	note 3	–	2	–	$\text{k}\Omega$
$C_i$	Input capacitance (differential)	note 3	–	3	–	pF
$G_{cr}$	gain control range		64	–	–	dB
$V_{i(rms)}$	maximum input signal (RMS value)		100	–	–	mV

# Integrated PAL and PAL/NTSC TV processors

TDA8360; TDA8361; TDA8362

SYMBOL	PARAMETER	CONDITIONS	MIN.	TYP.	MAX.	UNIT
VIDEO AMPLIFIER OUTPUT; NOTE 4 (PIN 7)						
V <sub>7</sub>	negative modulation	note 5	4.45	4.6	4.75	V
	zero signal output level					
V <sub>7</sub>	top sync level	note 5	1.9	2	2.1	V
	positive modulation (TDA8362)					
V <sub>7</sub>	zero signal output level	note 5	1.85	2	2.15	V
	white level					
ΔV <sub>7</sub>	difference in amplitude between negative and positive modulation		–	0	15	%
V <sub>7</sub>	detection level of black level for positive modulation when no peak white is available in the signal		–	3.1	–	V
Z <sub>O</sub>	video output impedance		–	–	50	Ω
I <sub>bias</sub>	internal bias current of NPN emitter follower output transistor		1	–	–	mA
I <sub>source</sub>	maximum source current		–	–	5	mA
B	bandwidth of demodulated output signal	–3 dB	6	9	–	MHz
G <sub>diff</sub>	gain differential	note 6	–	2	5	%
Φ <sub>diff</sub>	phase differential	notes 6 and 7	–	1	5	deg
NL <sub>vid</sub>	video non linearity	note 8	–	–	5	%
V <sub>th</sub>	white spot threshold voltage level		–	4.8	–	V
V <sub>ins</sub>	white spot insertion voltage level		–	3.2	–	V
N <sub>clamp</sub>	noise inverter clamping voltage level		–	1.4	–	V
N <sub>ins</sub>	noise inverter insertion level	note 9	–	2.6	–	V
δ <sub>mod</sub>	intermodulation	notes 7 and 10				
	blue	V <sub>o</sub> = 0.92 or 1.1 MHz	60	66	–	dB
	yellow	V <sub>o</sub> = 0.92 or 1.1 MHz	56	62	–	dB
	blue	V <sub>o</sub> = 2.66 or 3.3 MHz	60	66	–	dB
S/N	signal-to-noise ratio	notes 7 and 11				
			V <sub>i</sub> = 10 mV	52	60	–
V <sub>7</sub>	residual carrier signal	note 7				
			end of control range	52	61	–
V <sub>7</sub>	residual 2nd harmonic of carrier signal	note 7	–	0.5	–	mV

# Integrated PAL and PAL/NTSC TV processors

TDA8360; TDA8361; TDA8362

SYMBOL	PARAMETER	CONDITIONS	MIN.	TYP.	MAX.	UNIT
IF AND TUNER AGC; NOTE 12						
<i>Timing of IF-AGC (C48 = 2.2 <math>\mu</math>F)</i>						
	modulated video interference	30% AM for 1 to 100 mV; 0 to 200 Hz	–	–	10	%
$t_{inc}$	response time for an IF input signal amplitude increase of 52 dB for positive and negative modulation		–	2	–	ms
$t_{dec}$	response time for an IF input signal amplitude decrease of 52 dB for negative modulation for positive modulation (TDA8362)		–	25	–	ms
			–	100	–	ms
$I_{leak}$	allowed leakage current of the AGC capacitor for negative modulation for positive modulation	note 13				
			–	–	10	$\mu$ A
			–	–	200	nA
<i>Tuner take-over adjustment (pin 49)</i>						
$V_{49(rms)}$	minimum starting level voltage for tuner take-over (RMS value)		–	0.2	0.5	mV
$V_{49(rms)}$	maximum starting level voltage for tuner take-over (RMS value)		100	150	–	mV
$V_{cr}$	control voltage range		0.5	–	4.5	V
<i>Tuner control output (pin 47)</i>						
$V_{47}$	maximum tuner AGC output voltage	maximum gain	–	–	$V_P + 1$	V
$V_{47(sat)}$	output saturation voltage	minimum gain; $I_{47} = 2$ mA	–	–	300	mV
$I_{47}$	maximum tuner AGC output swing		5	–	–	mA
$I_{leak}$	leakage current RF AGC		–	–	1	$\mu$ A
$\Delta V_{47}$	input signal variation for complete tuner control	$I_{O(max)} = 1$ mA	1	2	4	dB
AFC OUTPUT; NOTE 14 (PIN 44)						
$V_{44}$	output voltage swing		–	6	–	V
$f_{sl}$	AFC slope		–	33	–	mV/kHz
$f_{os}$	AFC offset	note 7	–	–	50	kHz
$V_O$	output voltage at centre frequency		–	3.5	–	V
$Z_O$	output impedance		–	50	–	k $\Omega$
SWITCHING TO POSITIVE MODULATION (TDA8362); NOTE 15 (PIN 1)						
$V_1$	minimum voltage on pin 1 to switch the video demodulator and AGC to positive modulation		–	–	$V_P - 1$	V
$I_i$	input current		–	–	1	mA

# Integrated PAL and PAL/NTSC TV processors

TDA8360; TDA8361; TDA8362

SYMBOL	PARAMETER	CONDITIONS	MIN.	TYP.	MAX.	UNIT
<b>VIDEO IDENTIFICATION OUTPUT (PIN 4)</b>						
$V_O$	output voltage	video not identified	–	–	0.5	V
$Z_O$	output impedance		–	25	–	k $\Omega$
$V_O$	output voltage	video identified; colour signal available; $f_{osc} = 3.5$ MHz	–	6	–	V
		video identified; colour signal available/unavailable ; $f_{osc} = 4.4$ MHz	–	8	–	V
$t_d$	delay time of identification after the AGC has stabilized on a new transmitter		–	–	10	ms
$I_4$	maximum load current at pin 4		–	–	25	$\mu$ A
<b>Sound circuit</b>						
<b>DEMODULATOR INPUT; NOTE 16 (PIN 5)</b>						
$V_{5(rms)}$	input limiting for PLL catching range (RMS value)		–	1	2	mV
$\Delta f$	catching range PLL	note 17	4.2	–	6.8	MHz
$R_I$	DC input resistance	note 3	100	–	–	k $\Omega$
$C_I$	input capacitance	note 3	–	15	–	pF
AMR	AM rejection	$V_I = 50$ mV RMS; note 18	60	66	–	dB
<b>DE-EMPHASIS (PIN 1)</b>						
$V_{O(rms)}$	output signal amplitude (RMS value)	note 17	–	350	–	mV
$R_O$	output resistance		–	15	–	k $\Omega$
$V_1$	DC output voltage		–	3	–	V
<b>AUDIO ATTENUATOR OUTPUT (PIN 50)</b>						
$V_{50(rms)}$	controlled output signal amplitude (RMS value)	–6 dB; note 17	500	700	900	mV
$R_O$	output resistance		–	250	–	$\Omega$
$V_{50}$	DC output voltage		–	3.3	–	V
THD	total harmonic distortion	note 19	–	–	0.5	%
$S/N_{int}$	internal signal-to-noise ratio	note 7	–	60	–	dB
$S/N_{ext}$	external signal-to-noise ratio	note 7	–	80	–	dB
$VOL_{cr}$	control range	see also Fig.5	–	80	–	dB
OSS	suppression of output signal when mute is active		–	80	–	dB
$\Delta V_{50}$	DC shift of the output when mute is active	note 20	–	10	50	mV

# Integrated PAL and PAL/NTSC TV processors

## TDA8360; TDA8361; TDA8362

SYMBOL	PARAMETER	CONDITIONS	MIN.	TYP.	MAX.	UNIT
<b>EXTERNAL AUDIO INPUT (TDA8361, TDA8362); NOTE 21 (PIN 6)</b>						
$V_{6(rms)}$	input signal amplitude (RMS value)		–	350	700	mV
$R_I$	input resistance		–	25	–	k $\Omega$
$\Delta G_V$	voltage gain difference between input and output	maximum volume	–	12	–	dB
$\alpha_{cr}$	crosstalk between internal and external audio signals		60	–	–	dB
<b>CVBS/On-Screen Display and CD inputs</b>						
<b>INTERNAL AND EXTERNAL CVBS INPUTS (PINS 13 AND 15)</b>						
$V_{13(p-p)}$	internal CVBS input voltage (peak-to-peak value)	notes 3 and 22	–	2	2.8	V
$I_{13}$	internal CVBS input current		–	4	–	$\mu$ A
$V_{15(p-p)}$	external CVBS input voltage; TDA8361, TDA8362 (peak-to-peak value)	note 3	–	1	1.4	V
$I_{15}$	external CVBS input current; TDA8361, TDA8362		–	4	–	$\mu$ A
ISS	suppression of non-selected CVBS input signal; TDA8361, TDA8362	note 23	50	–	–	dB
<b>COMBINED CHROMINANCE AND SWITCH INPUT (TDA8361, TDA8362; PIN 16)</b>						
$V_{16(p-p)}$	chrominance input voltage (peak-to-peak value)	notes 3 and 24	–	0.3	–	V
$V_{16(p-p)}$	input signal amplitude before clipping occurs (peak-to-peak value)	note 7	1	–	–	V
$R_I$	chrominance input resistance		–	15	–	k $\Omega$
$C_I$	chrominance input capacitance	note 3	–	–	5	pF
$V_{16}$	DC input voltage to switch the A/V switch to internal mode		–	–	0.5	V
$V_{16}$	DC input voltage to switch the A/V switch to external mode		$V_P - 0.5$	–	–	V
$V_{16}$	DC input voltage for chrominance insertion		3	4	5	V
$SS_{CVBS}$	suppression of non-selected chrominance signal from CVBS input	notes 7 and 23	50	–	–	dB

# Integrated PAL and PAL/NTSC TV processors

TDA8360; TDA8361; TDA8362

SYMBOL	PARAMETER	CONDITIONS	MIN.	TYP.	MAX.	UNIT
<b>RGB INPUTS FOR ON-SCREEN DISPLAY (PINS 22, 23 AND 24)</b>						
$V_{22,23,24(p-p)}$	input signal amplitude for an output signal of 4V (black-to-white) (peak-to-peak value)	note 25	–	0.7	0.8	V
$V_{22,23,24(p-p)}$	input signal amplitude before clipping occurs (peak-to-peak value)		1	–	–	V
$V_{diff}$	difference of black level of internal and external signals at the outputs		–	–	100	mV
$I_{22,23,24}$	input currents		–	0.1	–	$\mu$ A
<b>FAST BLANKING (PIN 21)</b>						
$V_1$	fast blanking input voltage	no data insertion	–	–	0.4	V
$V_1$	fast blanking input voltage	data insertion	0.9	–	–	V
$V_{21(max)}$	maximum input pulse	data insertion	–	–	3	V
$t_d$	delay of data insertion		–	–	20	ns
$I_{21}$	input current		–	0.2	–	mA
$SS_{int}$	suppression of internal RGB signals with data insertion at $f = 0$ to 5 MHz	note 23	46	–	–	dB
$SS_{ext}$	suppression of external RGB signals with data insertion at $f = 0$ to 5 MHz	note 23	46	–	–	dB
$V_1$	input voltage to blank the RGB outputs to facilitate 'On-Screen-Display' signals being applied to these outputs	note 26	4	–	–	V
$t_d$	delay between the input pulse and the blanking at the output	note 7	–	30	–	ns
<b>COLOUR DIFFERENCE INPUT SIGNALS (PINS 28 AND 29)</b>						
$V_{29(p-p)}$	input signal amplitude (R–Y) (peak-to-peak value)		–	1.05	–	V
$V_{28(p-p)}$	input signal amplitude (B–Y) (peak-to-peak value)		–	1.35	–	V
$I_{28,29}$	input current for both inputs		–	0.1	1.0	$\mu$ A
<b>Chrominance filters</b>						
<b>CHROMINANCE TRAP CIRCUIT</b>						
$f_{trap}$	trap frequency		–	$f_{sc}$	–	MHz
QF	trap quality factor	notes 7 and 27	–	2	–	
SR	colour subcarrier rejection		20	–	–	dB
<b>CHROMINANCE BANDPASS CIRCUIT</b>						
$f_c$	centre frequency		–	$f_{sc}$	–	MHz
QBP	bandpass quality factor	note 7	–	3	–	

# Integrated PAL and PAL/NTSC TV processors

TDA8360; TDA8361; TDA8362

SYMBOL	PARAMETER	CONDITIONS	MIN.	TYP.	MAX.	UNIT
<b>Delay line and peaking circuit</b>						
Y DELAY LINE						
$t_d$	delay time	note 7	–	480	–	ns
B	bandwidth of internal delay line	note 7	8	–	–	MHz
PEAKING CONTROL; NOTE 28, SEE ALSO FIG.6 (PIN 14)						
$t_w$	width of preshoot or overshoot	at 50% of pulse; note 7	–	160	–	ns
$S_{cth}$	peaking signal compression threshold		–	50	–	IRE
$I_{14}$	input current when no video input signal present		–	1	–	mA
$V_1$	voltage level to switch off peaking		–	7	–	V
<b>Horizontal and vertical synchronization circuits</b>						
SYNC VIDEO INPUT (TDA8361, TDA8362; PINS 13 AND 15)						
$V_{13}$	sync pulse amplitude	referenced to pin 15; note 3	50	300	–	mV
SL	slicing level	note 29	–	50	–	%
VERTICAL SYNC						
$t_w$	width of the vertical sync pulse without sync instability	note 30	22	–	–	$\mu$ s
HORIZONTAL OSCILLATOR						
$f_{fr}$	free running frequency	note 44	–	15625	–	Hz
$\Delta f_{fr}$	spread on free running frequency		–	–	$\pm 2$	%
$\Delta f_{osc}/\Delta V_P$	frequency variation with respect to the supply voltage	$V_P = 8\text{ V} \pm 10\%$ ; note 7	–	0.2	0.5	%
$\Delta f_{osc}/\Delta T$	frequency variation with temperature	$T_{amb} = 25\text{ }^\circ\text{C} \pm 50\text{ }^\circ\text{C}$ ; note 7	–	1	–	Hz/K
$\Delta f_{osc(max)}$	maximum frequency deviation at the start of the horizontal output		–	–	75	%
FIRST CONTROL LOOP; NOTE 31 (FILTER CONNECTED TO PIN 40)						
$f_{HR}$	holding range PLL		–	$\pm 0.9$	$\pm 1.2$	kHz
$f_{CR}$	catching range PLL	note 7	$\pm 0.6$	$\pm 0.9$	–	kHz
S/N	signal-to-noise ratio of the video input signal at which the time constant is switched		–	20	–	dB
HYS	hysteresis at the switching point		–	3	–	dB



# Integrated PAL and PAL/NTSC TV processors

## TDA8360; TDA8361; TDA8362

SYMBOL	PARAMETER	CONDITIONS	MIN.	TYP.	MAX.	UNIT
SECOND CONTROL LOOP; NOTE 32 (CAPACITOR CONNECTED TO PIN 39)						
$\Delta\phi/\Delta\phi_0$	control sensitivity	without $R_L$ on pin 39	–	150	–	$\mu\text{s}/\mu\text{s}$
$t_{cr}$	control range from start of horizontal output to flyback		11	12	–	$\mu\text{s}$
$t_{shift}$	maximum horizontal shift range	note 7	$\pm 2$	–	–	$\mu\text{s}$
$\Delta\phi/\Delta\phi_0$	shift control sensitivity	note 7	–	3	–	$\mu\text{A}/\mu\text{s}$
$V_{39}$	voltage to switch on the X-ray protection		6	–	–	V
$I_I$	input current during protection		–	–	tbf	$\mu\text{A}$
HORIZONTAL OUTPUT (PIN 37)						
$V_{OL}$	LOW level output voltage	$I_O = 10 \text{ mA}$	–	–	0.3	V
$I_{O(max)}$	maximum allowed output current		10	–	–	mA
$V_{O(max)}$	maximum allowed output voltage		–	–	$V_P$	V
$\delta_{df}$	duty factor	note 7	–	50	–	%
FLYBACK INPUT/SANDCASTLE OUTPUT (PIN 38)						
$I_{38}$	required input current during flyback pulse	note 7	100	–	300	$\mu\text{A}$
$V_O$	output voltage during burst key		4.8	5.3	5.8	V
$V_O$	output voltage during blanking		1.8	2.0	2.2	V
$V_{icl}$	clamped input voltage during flyback		2.6	3.0	3.4	V
$t_W$	burst key pulse width		3.3	3.5	3.7	$\mu\text{s}$
$t_W$	vertical blanking pulse width	note 33	–	14	–	lines
$t_d$	delay of start of burst key to start of sync		5.2	5.4	5.6	$\mu\text{s}$
VERTICAL SECTION; NOTE 34						
$f_{fr}$	free running frequency		–	50/60	–	Hz
$f_{lock}$	locking range		45	–	64.5	Hz
	divider value not locked		–	625/525	–	
	locking range (lines/frame)		488	–	722	
VERTICAL RAMP GENERATOR (PIN 42)						
$I_{42}$	input current during scan	note 7	–	–	2	$\mu\text{A}$
$I_{dis}$	discharge current during retrace		–	0.3	–	mA
$V_{saw(p-p)}$	sawtooth amplitude (peak-to-peak value)	in 50 Hz mode	–	1.5	1.8	V
$t_d$	delay from field-to-field		–	–	1.6	$\mu\text{s}$

# Integrated PAL and PAL/NTSC TV processors

TDA8360; TDA8361; TDA8362

SYMBOL	PARAMETER	CONDITIONS	MIN.	TYP.	MAX.	UNIT
<b>VERTICAL OUTPUT (PIN 43)</b>						
$I_O$	available output current	note 7	1	–	–	mA
$I_{int}$	internal bias current of NPN emitter follower		–	0.2	–	mA
$V_{O(max)}$	maximum available output voltage		4	–	–	V
$V_{O(min)}$	minimum available output voltage		–	–	0.3	V
<b>VERTICAL FEEDBACK INPUT (PIN 41)</b>						
$V_{41}$	DC input voltage		2.0	2.5	3.0	V
$V_{41}$	AC input voltage		–	1	–	V
$I_{41}$	input current		–	–	15	$\mu$ A
$\Delta t_p$	internal pre-correction to sawtooth	note 35	–	3	–	%
$\Delta T/\Delta V$	temperature dependency on amplitude	$\Delta T = 40\text{ }^\circ\text{C}$	–	–	1	%
$V_{GL}$	vertical guard switching level with respect to the DC feedback level; switching level LOW		–	–	–1.5	V
$V_{GH}$	vertical guard switching level with respect to the DC feedback level; switching level HIGH		–	–	+1.5	V
$t_d$	delay of scan start	power on at 60 Hz	–	140	–	ms
<b>Colour demodulation part</b>						
<b>CHROMINANCE AMPLIFIER</b>						
$ACC_{cr}$	ACC control range	note 36	26	–	–	dB
$\Delta V$	change in amplitude of the output signals over the ACC range		–	–	2	dB
$THR_{on}$	threshold colour killer ON		–30	–	–38	dB
$HYS_{off}$	hysteresis colour killer OFF	note 7	–	–	–	–
	strong input signal	$S/N \geq 40\text{ dB}$	–	+3	–	dB
	noisy input signal		–	+1	–	dB
<b>ACL CIRCUIT</b>						
	chrominance burst ratio at which the ACL starts to operate		2.3	–	2.7	
<b>REFERENCE PART</b>						
<i>Phase-locked loop; note 37</i>						
$f_{CR}$	catching range		300	–	–	Hz
$\Delta\phi$	phase shift for a $\pm 200$ Hz deviation of the oscillator frequency	note 7	–	–	2	deg

# Integrated PAL and PAL/NTSC TV processors

## TDA8360; TDA8361; TDA8362

SYMBOL	PARAMETER	CONDITIONS	MIN.	TYP.	MAX.	UNIT
<i>Oscillator</i>						
$TC_{osc}$	temperature coefficient of $f_{osc}$	note 7	–	2.0	2.5	Hz/K
$\Delta f_{osc}$	$f_{osc}$ deviation with respect to $V_P$	note 7; $V_P = 8\text{ V} \pm 10\%$	–	–	250	Hz
$R_I$	input resistance (pin 34)	$f_i = 3.58\text{ MHz}$ ; note 4	–	1.5	–	k $\Omega$
$R_I$	input resistance (pin 35)	$f_i = 4.43\text{ MHz}$ ; note 4	–	1	–	k $\Omega$
$C_I$	input capacitance (pins 34 and 35)	note 4	–	–	10	pF
R	required resistance to $V_P$ to force the oscillator into one crystal mode		–	47	–	k $\Omega$
HUE CONTROL AND CHROMINANCE OUTPUT (TDA8361, TDA8362); NOTE 38 (PIN 27)						
$HUE_{cr}$	hue control range	see also Fig.7	$\pm 45$	$\pm 60$	–	deg
$\Delta HUE$	hue variation for $\pm 10\%$ $V_P$	note 7	–	0	5	deg
$\Delta HUE/\Delta T$	hue variation with temperature	$T_{amb} = 0\text{ to }+7\text{ }^\circ\text{C}$ ; note 7	–	0	–	deg
R	value of resistor connected to $V_P$ to switch the PAL decoder and to obtain a chrominance input signal for the TDA8395 (TDA8362)		4.7	10	12	k $\Omega$
$V_{O(p-p)}$	chrominance output signal to the TDA8395 (peak-to-peak value)	nominal output signal	–	330	–	mV
DEMODULATORS						
$V_{30(p-p)}$	(R–Y) output signal amplitude (peak-to-peak value)	note 39	–	0.525	–	V
$V_{31(p-p)}$	(B–Y) output signal amplitude (peak-to-peak value)	note 39	–	0.675	–	V
G	gain ratio of both demodulators $G(B-Y)/G(R-Y)$		1.6	1.78	1.96	
	spread of signal amplitude ratio PAL/NTSC	note 7	–1	–	+1	dB
$Z_O$	output impedance (R–Y)/(B–Y) output		–	250	–	$\Omega$
B	bandwidth of demodulators	–3 dB; note 40	–	650	–	kHz
$V_{30,31(p-p)}$	residual carrier output voltage (peak-to-peak value)	$f = f_{osc}$				
	(R–Y) output		–	–	10	mV
	(B–Y) output		–	–	10	mV
$V_{30,31(p-p)}$	residual carrier output voltage (peak-to-peak value)	$f = 2f_{osc}$				
	(R–Y) output		–	–	10	mV
	(B–Y) output		–	–	10	mV

# Integrated PAL and PAL/NTSC TV processors

## TDA8360; TDA8361; TDA8362

SYMBOL	PARAMETER	CONDITIONS	MIN.	TYP.	MAX.	UNIT
<b>DEMODULATORS</b>						
$V_{30(p-p)}$	H/2 ripple at (R-Y) output (peak-to-peak value)	only burst fed to input	–	–	25	mV
$\Delta V_O/\Delta T$	change of output signal amplitude with temperature	note 7	–	0.1	–	%/K
$\Delta V_O/\Delta V_P$	change of output signal amplitude with supply voltage	note 7	–	–	$\pm 0.1$	dB
$\varphi_e$	phase error in the demodulated signals		–	–	5	deg
<b>COLOUR DIFFERENCE MATRIXES IN CONTROL CIRCUIT</b>						
G-Y/(R-Y)	PAL/SECAM mode with TDA8362/TDA8395	–(R-Y) and –(B-Y) not affected	–	–0.51 $\pm 10\%$	–	
G-Y/(B-Y)			–	–0.19 $\pm 25\%$	–	
–(B-Y)	NTSC mode; the CD matrix results in the following signal (1.14/–10°)	nominal hue setting	–1.12U <sub>R</sub> – 1.12V <sub>R</sub>			
–(R-Y)	NTSC mode; the CD matrix results in the following signal (1.14/100°)	nominal hue setting	–0.20U <sub>R</sub> + 1.12V <sub>R</sub>			
G-Y	NTSC mode; the CD matrix results in the following signal (0.30/235°)	nominal hue setting	–0.25V <sub>R</sub> – 0.17U <sub>R</sub>			
<b>REFERENCE SIGNAL OUTPUT FOR TDA8395 (TDA8362; PIN 32)</b>						
$f_{ref}$	reference frequency	note 41	–	4.43	–	MHz
$V_{32(p-p)}$	output signal amplitude (peak-to-peak value)		0.2	0.25	0.3	V
$V_O$	output voltage level	PAL/NTSC identified	–	1.5	–	V
$V_O$	output voltage level	no PAL/NTSC; SECAM (by TDA8395) identified	–	5	–	V
$I_{32}$	required current to force TDA8362/TDA8395 combination in SECAM mode		150	–	–	$\mu A$
<b>Control part</b>						
<b>SATURATION CONTROL; NOTE 25 (PIN 26)</b>						
SAT <sub>cr</sub>	saturation control range	see also Fig.8	52	–	–	dB
$\Delta SAT/\Delta V$	saturation level change	$V_P = \pm 10\%$ ; note 7	–	0	–	%
$I_I$	input current	no colour identified	–	1	–	mA
$V_{ctr}$	control voltage to switch colour PLL in the free-running mode	note 37	$V_P - 1$	–	–	V

# Integrated PAL and PAL/NTSC TV processors

TDA8360; TDA8361; TDA8362

SYMBOL	PARAMETER	CONDITIONS	MIN.	TYP.	MAX.	UNIT
CONTRAST CONTROL; NOTE 25 (PIN 25)						
CON <sub>cr</sub>	contrast control range	see also Fig.9	–	20	–	dB
	tracking between the three channels over a control range of 10 dB		–	–	0.7	dB
BRIGHTNESS CONTROL (PIN 17)						
BRI <sub>cr</sub>	brightness control range	see also Fig.10	–	±1	–	V
RGB AMPLIFIERS (PINS 18, 19 AND 20)						
V <sub>18,19,20(p-p)</sub>	output signal amplitudes (peak-to-peak value)	nominal luminance input signal and nominal contrast; note 25	3.5	4.0	4.5	V
V <sub>20(p-p)</sub>	output signal amplitudes for the RED channel (peak-to-peak value)	nominal settings for contrast and saturation control and no luminance signal to the R–Y signal (PAL)	3.8	4.2	4.6	V
V <sub>18,19,20</sub>	blanking level at the RGB outputs		0.5	0.6	0.8	V
V <sub>18,19,20</sub>	black level at the RGB outputs	note 25	1.2	1.3	1.4	V
V <sub>pwt</sub>	maximum peak white level	note 42	–	6	–	V
I <sub>O</sub>	available output current		5	–	–	mA
Z <sub>O</sub>	output impedance		–	150	–	Ω
I <sub>source</sub>	current source of output stage		1.8	2.0	–	mA
	relative spread between the RGB output signals		–	–	5	%
S/N	signal-to-noise ratio of output signals for RGB input	note 43	–	60	–	dB
	for CVBS input	note 7	50	56	–	dB
f <sub>res(p-p)</sub>	residual frequency at f <sub>osc</sub> in the RGB outputs (peak-to-peak value)	note 23	–	–	25	mV
f <sub>res(p-p)</sub>	residual frequency at 2f <sub>osc</sub> plus higher harmonics in the RGB outputs (peak-to-peak value)		–	–	25	mV
V <sub>diff</sub>	difference in black level between the three outputs	nominal brightness	–	–	100	mV
V <sub>bl</sub>	black level shift with picture content	note 7	–	0	–	mV
Δbl/ΔT	variation of black level with temperature	note 7	–2	–	0	mV/K

# Integrated PAL and PAL/NTSC TV processors

TDA8360; TDA8361; TDA8362

SYMBOL	PARAMETER	CONDITIONS	MIN.	TYP.	MAX.	UNIT
RGB AMPLIFIERS (PINS 18, 19 AND 20)						
$\Delta bl/\Delta CON$	variation of black level over contrast range	nominal saturation; note 7	–	–	100	mV
$\Delta bl/\Delta SAT$	variation of black level over saturation range	nominal contrast; note 7	–	–	50	mV
$\Delta bl$	relative variation in black level between the three channels during variations of					
	supply voltage ( $\pm 10\%$ )	nominal saturation	–	–	50	mV
	saturation (50 dB)	nominal contrast	–	–	25	mV
	contrast (20 dB)	nominal saturation	–	–	60	mV
	brightness ( $\pm 0.5$ V)	nominal controls	–	–	100	mV
$V_{diff}$	differential drift of black level over a temperature range of 40 °C	note 7	–	–	10	mV
B	bandwidth of output signals for	–3 dB				
	RGB input		8	–	–	MHz
	CVBS input	$f_{osc} = 3.58$ MHz	–	2.8	–	MHz
	CVBS input	$f_{osc} = 4.43$ MHz	–	3.5	–	MHz
	S-VHS input		8	–	–	MHz

## Notes to the "Characteristics"

- It is possible to start the horizontal oscillator when a current of 5.5 mA is supplied to this pin. In this condition the main part of the IC is not active and this results in the frequency of the oscillator not being controlled at the correct value. Consequently, the oscillator frequency will be higher than normal, the maximum deviation will be 75%. When the start-up function is used the maximum voltage on pin 36 must be limited to 8.8 volts.
- On set AGC.
- This parameter is not tested during production and is just given as application information for the designer of the television receiver.
- Measured at 10 mV RMS top sync input signal.
- So called projected zero point, i.e. with switched demodulator.
- Measured in accordance with the test line given in Fig.11. For the differential phase test the peak white setting is reduced to 87%.  
The differential gain is expressed as a percentage of the difference in peak amplitudes between the largest and smallest value relative to the subcarrier amplitude at blanking level.  
The phase difference is defined as the difference in degrees between the largest and smallest phase angle.
- This parameter is not tested during production but is guaranteed by the design and qualified by means of matrix batches which are made in the pilot production period.
- This figure is valid for the complete video signal amplitude (peak white-to-black), see Fig.12.
- Insertion (suppression of the interference pulses) to a level of 2.6 V is active only during a strong input signal. This is because the noise inverter has a negative effect on the sound performance at a weak input signal.
- The test set-up and input conditions are given in Fig.13. The figures are measured with an input signal of 10 mV RMS.

# Integrated PAL and PAL/NTSC TV processors

## TDA8360; TDA8361; TDA8362

11. Measured with a source impedance of 75 Ω, where:

$$S/N = 20 \log \frac{V_O \text{ (black-to-white)}}{\sqrt{V_{m \text{ (rms)}}} (B = 5 \text{ MHz})}$$

12. To obtain a good noise immunity of the AGC circuit the AGC detector is gated during the sync pulse. This gating is switched off during the vertical retrace to avoid disturbances of the signal amplitude due to phase errors of the incoming video signal which are caused by the head-switching of VCRs.
13. When the leakage current of the capacitor exceeds this value it will result in a reduced performance of the AGC (amplitude variation during line or frame) but it will not result in a hang-up situation.
14. The AFC slope is directly related to the Q-factor of the demodulator tuned circuit. The given AFC steepness is obtained with a Q-factor of 60. When a lower steepness is required this can be obtained by connecting an external resistor to the AFC output (the output impedance is 50 kΩ). The AFC off-set is tested with a double sideband input signal and with the reference tuned circuit tuned to minimum AGC voltage (optimum tuning for the demodulator).
15. For positive modulated signals the FM sound demodulator for the sound is not required. This is because the sound signal is amplitude modulated. Therefore the TDA8362 can be switched to positive modulation via the de-emphasis pin (pin 1). When switched to positive modulation the audio switch is set to 'external' so that the demodulated audio signal can be supplied to the input. The option between AM sound and SCART audio signals is achieved by means of an external switch.
16. The sound IF input is combined with the AF volume control. The IF signal is internally AC coupled to the limiter amplifier. The volume control voltage must be supplied to this pin via a resistor.
17.  $V_1 = 100 \text{ mV RMS}$ ; FM: 1 kHz,  $\Delta f = \pm 50 \text{ kHz}$ .
18.  $V_1 = 50 \text{ mV RMS}$ ,  $f = 4.5/5.5 \text{ MHz}$ ;  
FM: 70 Hz  $\pm 50 \text{ kHz}$  deviation  
AM: 1 kHz at 30% modulation.
19.  $V_1 = 100 \text{ mV RMS}$ , 5.5 MHz; FM: 1 kHz,  $\pm 17.5 \text{ kHz}$  deviation; 15 kHz bandwidth; audio attenuator at -6 dB.
20. Audio attenuator at -20 dB; temperature range 10 to 50 °C.
21. In the TDA8361 and TDA8362 the audio and CVBS switches are controlled via the chrominance input pin. Table 1 lists the various possibilities.  
When the DC voltage has a value between 3 and 5 V the switches are set to the S-VHS position. The chrominance trap is then switched off and separate Y and chrominance signals have to be applied to the inputs (the audio switch is set to external in this condition). The audio switch is also set to external when the IF amplifier is switched to positive modulation (see also note 15).
22. Signal with negative-going sync. Amplitude includes sync pulse amplitude.
23. This parameter is measured at nominal settings of the various control voltages.
24. Burst amplitude; for a colour bar with 75% saturation the chrominance signal amplitude is 660 mV (p-p).
25. Nominal contrast is specified as maximum contrast -3 dB. Nominal saturation as maximum -12 dB. The nominal brightness control voltage is 2.5 V.
26. When the data blanking input pulse exceeds a level of 4 V the RGB outputs are blanked. In this condition it is possible to supply 'On-Screen-Display' signals to the outputs. This blanking overrules both the internal and external RGB signals.
27. The -3 dB bandwidth of the circuit can be calculated by means of the following equation:

$$f_{-3 \text{ dB}} = f_{\text{osc}} \left( 1 - \frac{1}{2Q} \right)$$

## Integrated PAL and PAL/NTSC TV processors

TDA8360; TDA8361; TDA8362

28. The amplitude response curve can be expressed as follows:

$$A(f) = 1 + K1 - \cos(180 \times f/3.1 \text{ MHz})$$

and is realised with a transversal peaking filter having delay sections of 160 ns each. In the 'neutral' setting  $K = 0$  and in the minimum setting  $K = -0.5$ .

The peaking signal amplifier is linear for 250 ns step input signals up to 50 IRE units. For higher amplitudes the marginal gain is reduced. When the horizontal PLL is not synchronized (no signal present at the video input) the peaking control voltage is pulled down by means of an internal current. This information can be used to detect whether an input signal is available.

29. Slicing level independent of sync pulse amplitude.

30. The horizontal and vertical sync are stable while processing Copy Guard signals and signals with phase shifted sync pulses (stretched tapes). Trick mode conditions of the VCR will also not disturb the synchronization. The value given is the delay caused by the vertical sync pulse integrator. The integrator has been designed such that the vertical sync is not disturbed for special anti-copy tapes with vertical sync pulses with an on/off time of 10/22  $\mu\text{s}$ .

31. To obtain a good performance for both weak signal and VCR playback the time constant of the first control loop is switched depending on the input signal condition. Therefore the circuit contains a noise detector and the time constant is switched to 'slow' when excessive noise is present in the signal (only when the internal video signal is selected, when the video switch is in the external mode the time constant is always 'fast'). In the 'fast' mode during the vertical retrace time the phase detector current is increased 50% so that phase errors due to head-switching of the VCR are corrected as soon as possible.

When no video signal is received the time constant of the first loop is switched to 'very slow'. This ensures a stable OSD when the receiver is switched to a channel without transmitter.

The output current of the phase detector for the various conditions is shown in Table 2.

32. Picture shift can be obtained by means of a variable external load on the second phase detector. The control range is  $\pm 2 \mu\text{s}$ ; the required current for this phase shift is  $\pm 6 \mu\text{A}$ .
33. The vertical blanking pulse in the RGB outputs has a width of 22 or 17.5 lines (50 or 60 Hz system). The width of the vertical sync pulse in the sandcastle pulse is 14 lines. This is to prevent a phase distortion on top of the picture due to a timing modulation of the incoming flyback pulse.
34. The timing pulses for the vertical ramp generator are obtained from the horizontal oscillator via a divider circuit. This divider circuit has 2 search modes of operation:
- The 'large window' mode is switched on when the circuit is not synchronized or, when a non-standard signal is received (the number of lines per frame in the 50 Hz mode is between 311 and 314 and in the 60 Hz mode between 261 and 264). In the search mode the divider can be triggered between line 244 and line 361 (approximately 45 to 64.5 Hz)
- The 'narrow window' mode is switched on when more than 15 successive vertical sync pulses are detected in the narrow window. When the circuit is in the standard mode and a vertical sync pulse is missing the retrace of the vertical ramp generator is started at the end of the window. Consequently, the disturbance of the picture is very small. The circuit will switch back to the search window when, for 6 successive vertical periods, no sync pulses are found within the window.
35. This precorrection is intended to compensate for non-linearity of AC coupled vertical output stages. The value given indicates the amplitude of the correction waveform with respect to the sawtooth amplitude.
36. At a chrominance input voltage (related to CVBS2) of 660 mV (p-p) (colour bar with 75% saturation i.e. burst signal amplitude 300 mV (p-p)) the dynamic range of the ACC is +6 and -20 dB.



## Integrated PAL and PAL/NTSC TV processors

TDA8360; TDA8361; TDA8362

37. All frequency variations are referenced to 3.58/4.43 MHz carrier frequency.  
 All oscillator specifications are measured with the Philips crystal series 9922 520.  
 If the spurious response of the 4.43 MHz crystal is lower than  $-3$  dB with respect to the fundamental frequency for a damping resistance of  $1\text{ k}\Omega$ , oscillation at the fundamental frequency is guaranteed.  
 The spurious response of the 3.58 MHz crystal must be lower than  $-3$  dB with respect to the fundamental frequency for a damping resistance of  $1.5\text{ k}\Omega$ .  
 The catching and detuning range are measured for nominal crystal parameters. These are:
- load resonance frequency  $f_0$  ( $C_L = 20\text{ pF}$ ) = 4.433619 or 3.579545 MHz
  - motional capacitance  $C_M = 20.6\text{ fF}$  (4.43 MHz crystal) or (3.58 MHz crystal)
  - parallel capacitance  $C_0 = 5.5\text{ pF}$  (4.43 MHz crystal) or  $4.5\text{ pF}$  (3.58 MHz crystal).
- The actual load capacitance in the application should be  $C_L = 18\text{ pF}$  to account for parasitic capacitances on and off chip.  
 The free-running frequency of the oscillator can be checked by pulling the saturation control pin to the positive supply rail. In that condition the colour killer is not active so that the frequency off-set is visible on the screen. When two crystals are connected to the IC the circuit must be forced to one of the crystals during this test to prevent the oscillator continuously switching between the two frequencies.
38. In the TDA8362 the hue control pin has a double function. When the control voltage has a value of 0 to 5 V (normal control range) the hue can be controlled when NTSC signals are decoded. When this voltage is increased to a value greater than 5.5 V the decoder is forced to the PAL standard. When this pin is connected to the positive supply line via a  $10\text{ k}\Omega$  resistor the selected CVBS signal, of the CVBS switch, is available. This signal can be applied to the SECAM decoder TDA8395.  
 The phase shift of the hue control can be measured at the colour difference outputs (pins 30 and 31).
39. The  $-(R-Y)$  and  $-(B-Y)$  signals are demodulated with the  $90^\circ$  phase difference of the reference carrier and a gain ratio  $-(B-Y)/-(R-Y) = 1.78$ . The matrixing to the required signals is achieved in the control part.
40. This value indicates the bandwidth of the complete chrominance circuit including the chrominance bandpass filter. The bandwidth of the demodulator low-pass filter is approximately 1 MHz.
41. The reference signal for the TDA8395 is available only when the crystal oscillator is operating at a frequency of 4.43 MHz. When a SECAM signal is identified this signal is only available during the vertical retrace period thus avoiding crosstalk with the incoming SECAM signal during scan.
42. When one of the three output signals exceeds this level the gain of the amplifiers is reduced. This is achieved by a reduction of contrast and thus avoids clipping of the output signals. The discharge current at pin 25 is 0.2 mA. When the black level exceeds a value of 2 V the maximum peak-to-peak value of the video output signal will be less than 4 V (p-p); this is due to the operation of the peak-white limiter.
43. The signal-to-noise ratio is specified as a peak-to-peak signal with respect to RMS noise (bandwidth 5 MHz). During the measurement the peaking control voltage is set to nominal.
44. The typical free running frequency is dependent on the crystal which is used for calibration. With 4.4 MHz the typical free running frequency is 15625, with 3.58 MHz the typical free running frequency is 15734.  
 Calibration during start-up is always carried out with a 4.4 MHz crystal if no forced mode is used.

# Integrated PAL and PAL/NTSC TV processors

## TDA8360; TDA8361; TDA8362

**Table 1** Audio and CVBS switch selection.

LEVEL (pin 16)	INTERNAL CVBS	EXTERNAL CVBS/Y	CHROMINANCE	CHROMINANCE TRAP	AUDIO
$DC \leq 0.5 \text{ V}$	ON	OFF	OFF	ON	internal
$3 \leq DC \leq 5 \text{ V}$	OFF	ON (Y)	ON	OFF	external
$DC \geq 7.5 \text{ V}$	OFF	ON (CVBS)	OFF	ON	external

**Table 2** Output current of phase detector.

CURRENT $\Phi 1$ DURING	SCAN ( $\mu\text{A}$ )	VERTICAL RETRACE ( $\mu\text{A}$ )	GATED YES/NO
Weak signal and synchronized	30	30	YES (5.7 $\mu\text{s}$ )
Strong signal and synchronized	180	270	NO
Not synchronized	180	270	NO
No video identification	6	6	NO

### QUALITY SPECIFICATION

Quality level in accordance with UZW B0/FQ-0601.

SYMBOL	PARAMETER	RANGE A	RANGE B	UNIT
ESD	protection circuit specification (note 1)	2000	200	V
		100	200	pF
		1500	0	$\Omega$

**Note**

- All pins are protected against ESD by means of internal clamping diodes.

# Integrated PAL and PAL/NTSC TV processors

## TDA8360; TDA8361; TDA8362

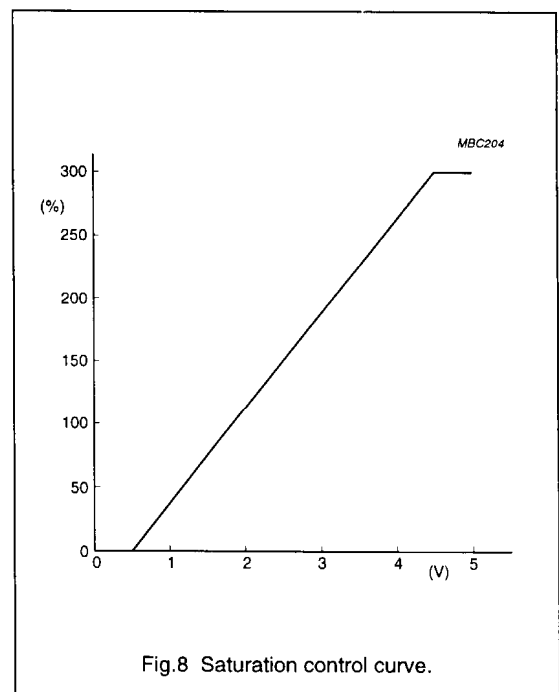
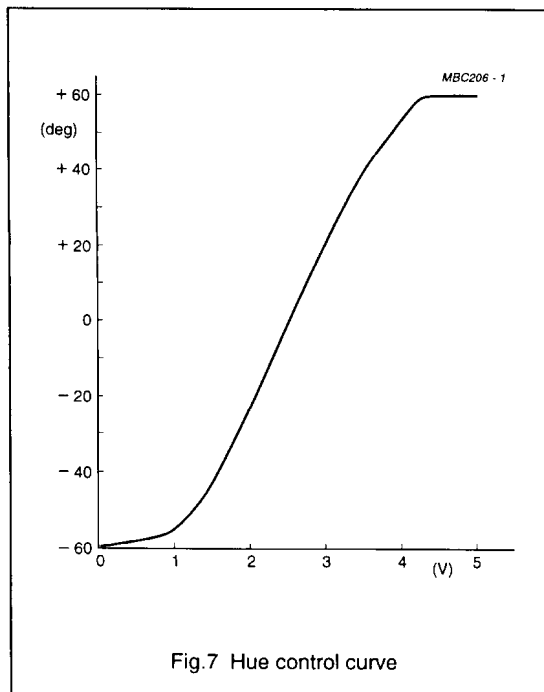
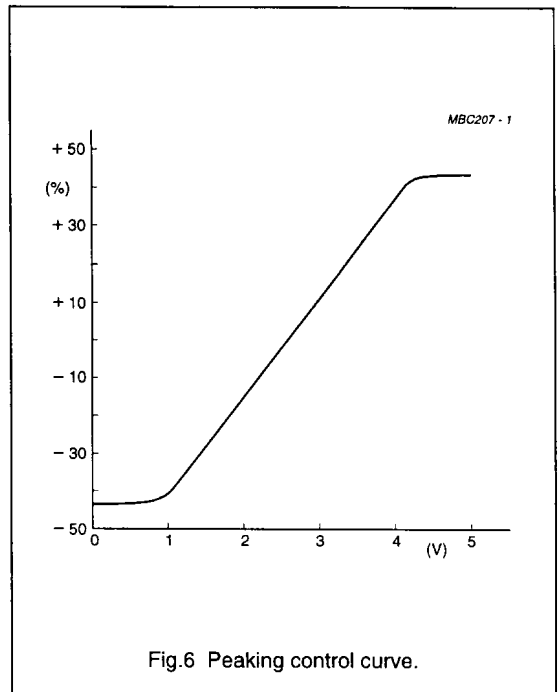
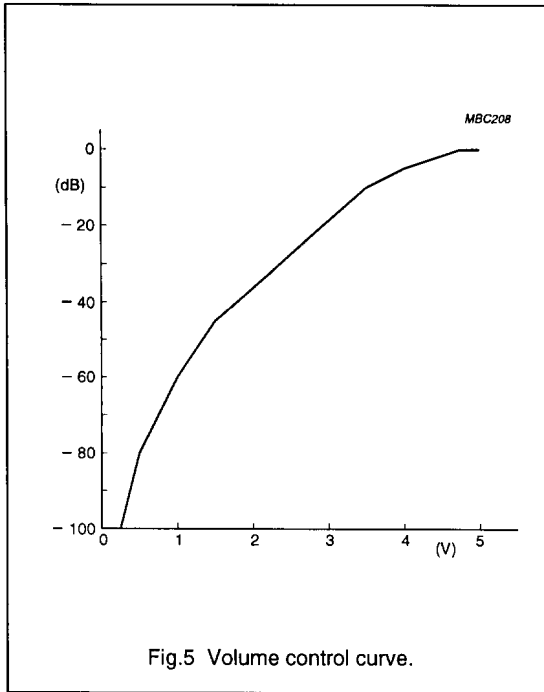

Integrated PAL and PAL/NTSC TV processors

TDA8360; TDA8361; TDA8362

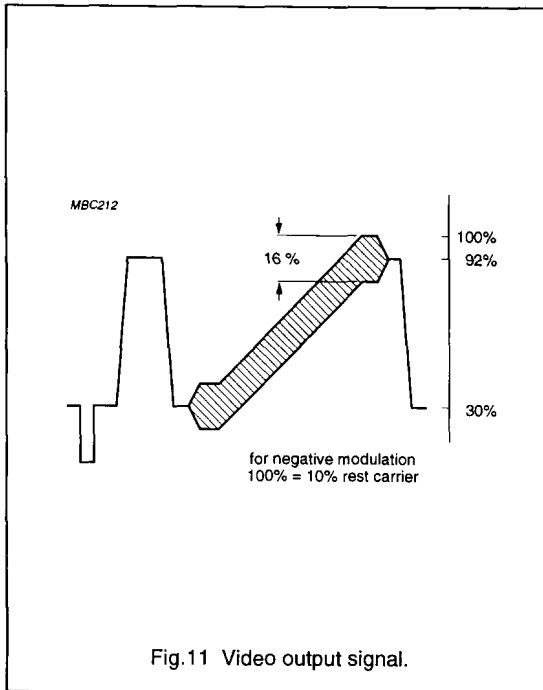
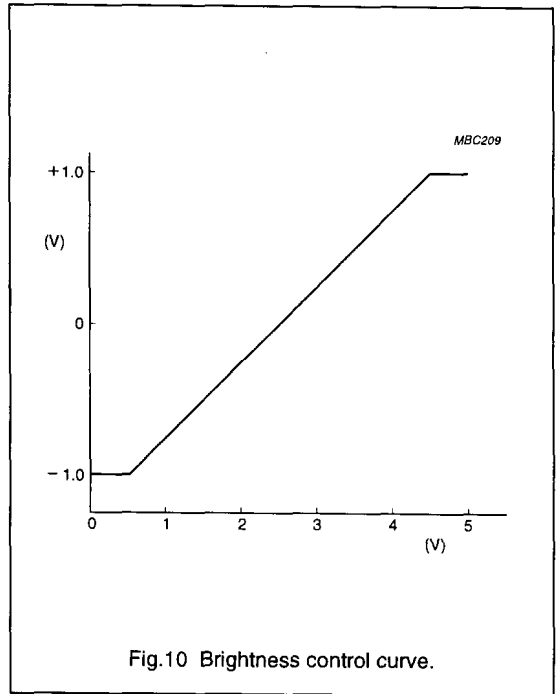
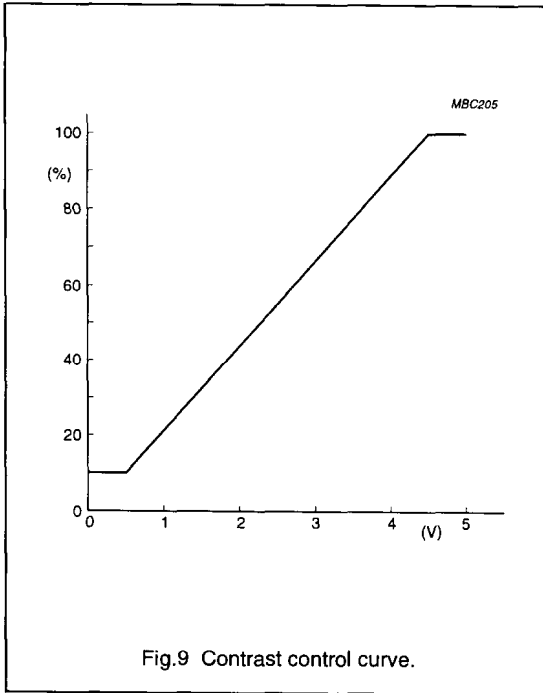

Integrated PAL and PAL/NTSC TV processors

TDA8360; TDA8361; TDA8362

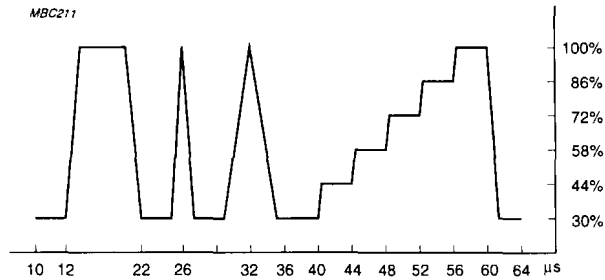
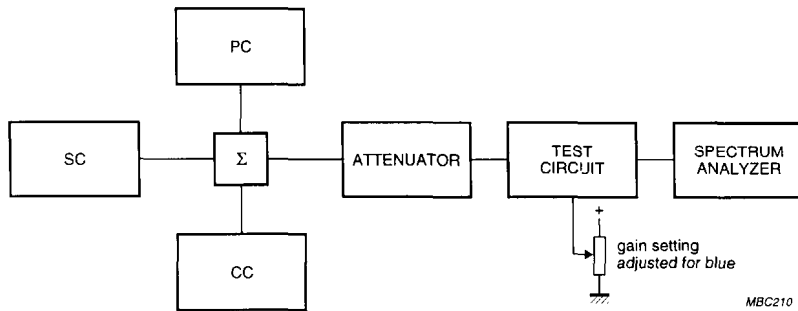
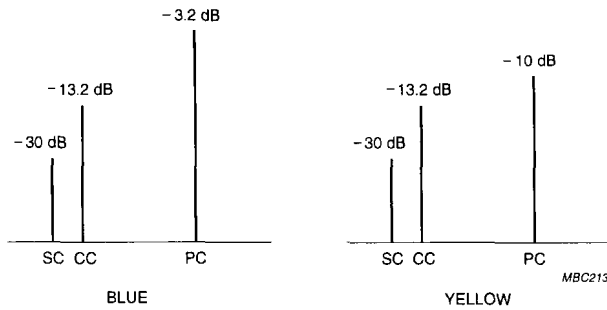

Fig.12 Test signal waveform.



Input signal conditions: SC = sound carrier; CC = colour carrier; PC = picture carrier.  
All amplitudes with respect to top sync level.

$$\text{Value at 0.92 or 1.1 MHz} = 20 \log \frac{V_O \text{ at 3.58 or 4.4 MHz}}{V_O \text{ at 0.92 or 1.1 MHz}} + 3.6 \text{ dB}$$

$$\text{Value at 2.66 or 3.3 MHz} = 20 \log \frac{V_O \text{ at 3.58 or 4.4 MHz}}{V_O \text{ at 2.66 or 3.3 MHz}}$$

Fig.13 Test set-up intermodulation.