

### Chip Resistor Array

- Type: **EXB1 : 0201 Array**  
**EXB2 : 0402 Array**  
**EXB3 : 0603 Array**  
**EXBN : 0402 Array**  
**EXBV : 0603 Array**  
**EXBS : 0805 Array**

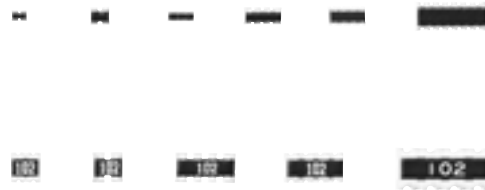

#### Features

- High density
  - 2 resistors in 0.8 mm × 0.6 mm size (EXB14V)
  - 4 resistors in 1.4 mm × 0.6 mm size (EXB18V)
  - 2 resistors in 1.0 mm × 1.0 mm size (EXB24V)
  - 4 resistors in 2.0 mm × 1.0 mm size (EXB28V, N8V)
  - 8 resistors in 3.8 mm × 1.6 mm size (EXB2HV)
  - 2 resistors in 1.6 mm × 1.6 mm size (EXB34V, V4V)
  - 4 resistors in 3.2 mm × 1.6 mm size (EXB38V, V8V)
  - 4 resistors in 5.1 mm × 2.2 mm size (EXBS8V)
- Improvement of placement efficiency  
 Placement efficiency of Chip Resistor Array is two, four or eight times of the flat type chip resistor
- Reference Standard: IEC 60115-9, JIS C 5201-9, EIAJ RC-2129
- AEC-Q200 qualified (EXB2, EXB3)
- RoHS compliant

#### Packaging Methods, Land Pattern, Soldering Conditions and Safety Precautions

Please see Data Files

#### Explanation of Part Numbers

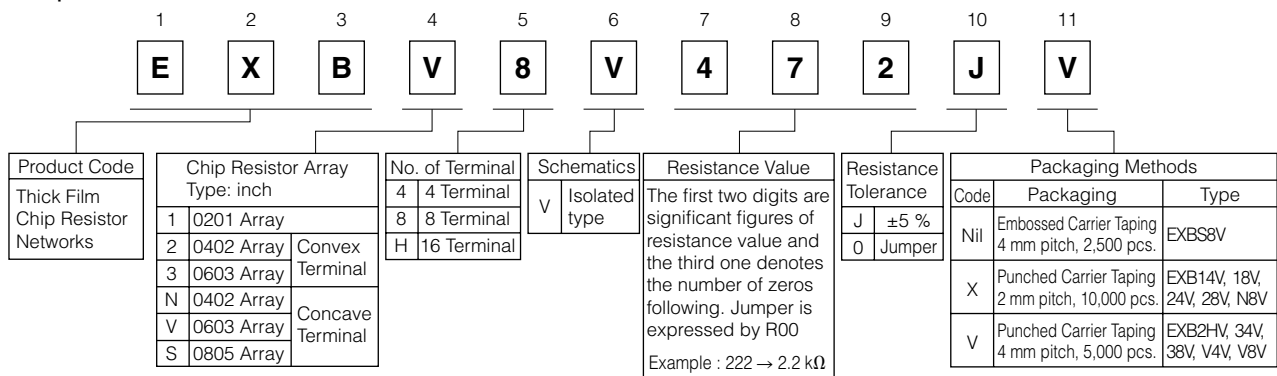

#### Construction (Example : Concave Terminal)

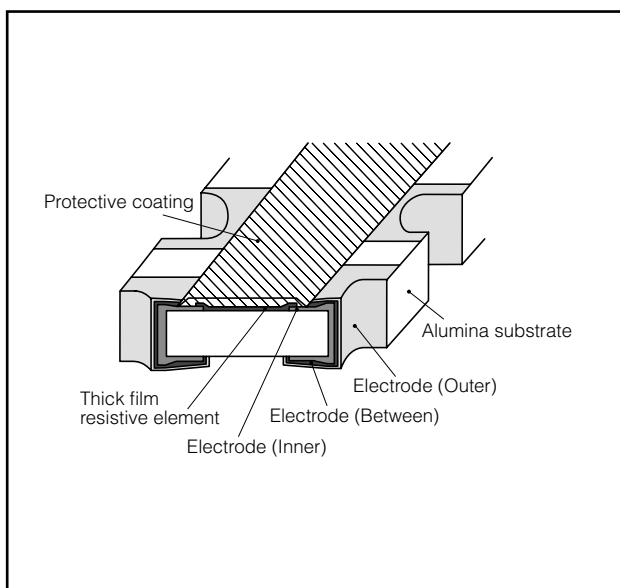

#### Schematics

- Isolated type

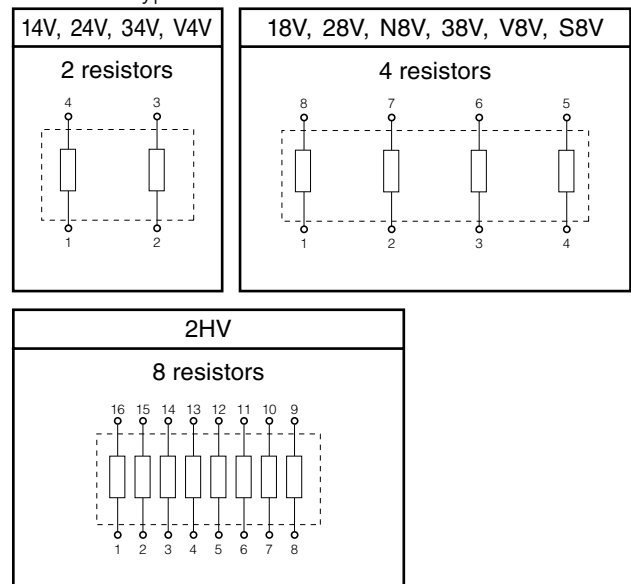

Design and specifications are each subject to change without notice. Ask factory for the current technical specifications before purchase and/or use. Should a safety concern arise regarding this product, please be sure to contact us immediately.

## ■ Dimensions in mm (not to scale)

### (1) Convex Terminal type

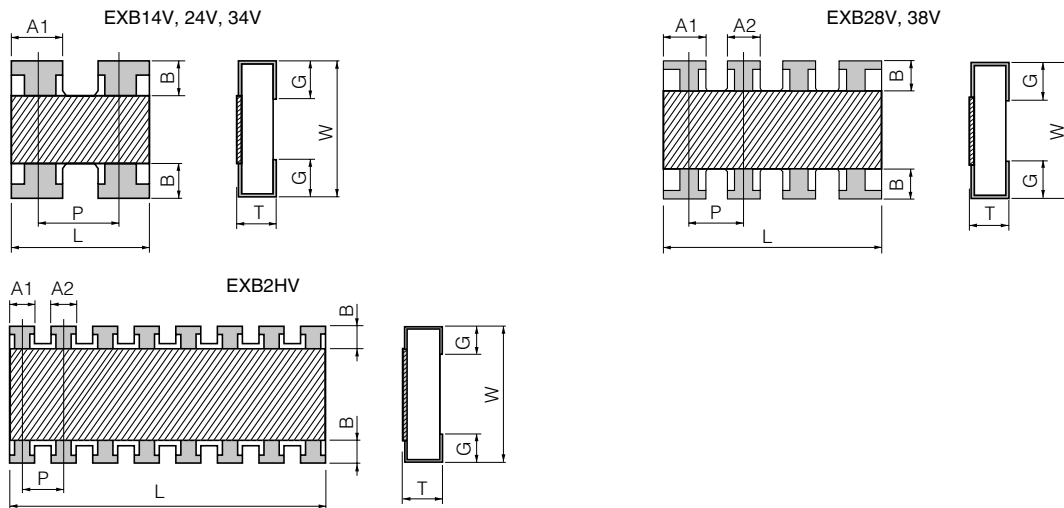

Type (inch size)	Dimensions (mm)								Mass (Weight) [g/1000 pcs.]
	L	W	T	A1	A2	B	P	G	
EXB14V (0201×2)	0.80 <sup>±0.10</sup>	0.60 <sup>±0.10</sup>	0.35 <sup>±0.10</sup>	0.35 <sup>±0.10</sup>	—	0.15 <sup>±0.10</sup>	(0.50)	0.15 <sup>±0.10</sup>	0.5
EXB24V (0402×2)	1.00 <sup>±0.10</sup>	1.00 <sup>±0.10</sup>	0.35 <sup>±0.10</sup>	0.40 <sup>±0.10</sup>	—	0.18 <sup>±0.10</sup>	(0.65)	0.25 <sup>±0.10</sup>	1.2
EXB28V (0402×4)	2.00 <sup>±0.10</sup>	1.00 <sup>±0.10</sup>	0.35 <sup>±0.10</sup>	0.45 <sup>±0.10</sup>	0.35 <sup>±0.10</sup>	0.20 <sup>±0.10</sup>	(0.50)	0.25 <sup>±0.10</sup>	2.0
EXB2HV (0402×8)	3.80 <sup>±0.10</sup>	1.60 <sup>±0.10</sup>	0.45 <sup>±0.10</sup>	0.35 <sup>±0.10</sup>	0.35 <sup>±0.10</sup>	0.30 <sup>±0.10</sup>	(0.50)	0.30 <sup>±0.10</sup>	9.0
EXB34V (0603×2)	1.60 <sup>±0.20</sup>	1.60 <sup>±0.15</sup>	0.50 <sup>±0.10</sup>	0.65 <sup>±0.15</sup>	—	0.30 <sup>±0.20</sup>	(0.80)	0.30 <sup>±0.20</sup>	3.5
EXB38V (0603×4)	3.20 <sup>±0.20</sup>	1.60 <sup>±0.15</sup>	0.50 <sup>±0.10</sup>	0.65 <sup>±0.15</sup>	0.45 <sup>±0.15</sup>	0.30 <sup>±0.20</sup>	(0.80)	0.35 <sup>±0.20</sup>	7.0

### (2) Concave Terminal type

( ) Reference

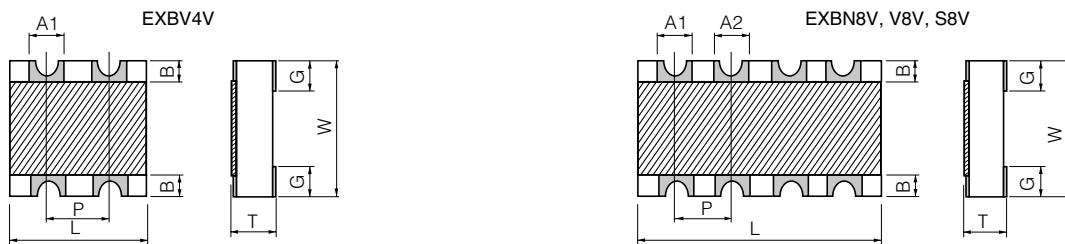

Type (inch size)	Dimensions (mm)								Mass (Weight) [g/1000 pcs.]
	L	W	T	A1	A2	B	P	G	
EXBN8V (0402×4)	2.00 <sup>±0.10</sup>	1.00 <sup>±0.10</sup>	0.45 <sup>±0.10</sup>	0.30 <sup>±0.10</sup>	0.30 <sup>±0.10</sup>	0.20 <sup>±0.15</sup>	(0.50)	0.30 <sup>±0.15</sup>	3.0
EXBV4V (0603×2)	1.60 <sup>+0.20/-0.10</sup>	1.60 <sup>+0.20/-0.10</sup>	0.60 <sup>±0.10</sup>	0.60 <sup>±0.10</sup>	—	0.30 <sup>±0.15</sup>	(0.80)	0.45 <sup>±0.15</sup>	5.0
EXBV8V (0603×4)	3.20 <sup>+0.20/-0.10</sup>	1.60 <sup>+0.20/-0.10</sup>	0.60 <sup>±0.10</sup>	0.60 <sup>±0.10</sup>	0.60 <sup>±0.10</sup>	0.30 <sup>±0.15</sup>	(0.80)	0.45 <sup>±0.15</sup>	10
EXBS8V (0805×4)	5.08 <sup>+0.20/-0.10</sup>	2.20 <sup>+0.20/-0.10</sup>	0.70 <sup>±0.20</sup>	0.80 <sup>±0.15</sup>	0.80 <sup>±0.15</sup>	0.50 <sup>±0.15</sup>	(1.27)	0.55 <sup>±0.15</sup>	30

### (3) Flat Terminal type

( ) Reference

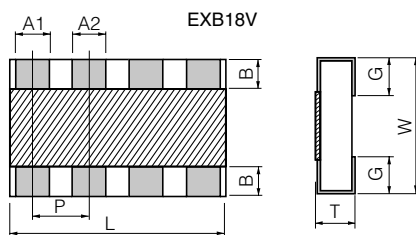

Type (inch size)	Dimensions (mm)								Mass (Weight) [g/1000 pcs.]
	L	W	T	A1	A2	B	P	G	
EXB18V (0201×4)	1.40 <sup>±0.10</sup>	0.60 <sup>±0.10</sup>	0.35 <sup>±0.10</sup>	0.20 <sup>±0.10</sup>	0.20 <sup>±0.10</sup>	0.10 <sup>±0.10</sup>	(0.40)	0.20 <sup>±0.10</sup>	1.0

( ) Reference

Design and specifications are each subject to change without notice. Ask factory for the current technical specifications before purchase and/or use. Should a safety concern arise regarding this product, please be sure to contact us immediately.

## ■ Ratings

Item		Specifications
Resistance Range		10 Ω to 1 MΩ : E24 series
Resistance Tolerance		J : ±5 %
Number of Terminals	14V,24V,V4V,34V	4 terminal
	18V,28V,N8V,38V,V8V,S8V	8 terminal
	2HV	16 terminal
Number of Resistors	14V,24V,V4V,34V	2 element
	18V,28V,N8V,38V,V8V,S8V	4 element
	2HV	8 element
Power Rating at 70 °C	14V,N8V	0.031 W/element
	18V	0.031 W/element (0.1 W/package)
	24V,28V,V4V,34V,V8V,38V	0.063 W/element
	S8V	0.1 W/element
	2HV	0.063 W/element (0.25 W/package)

Item		Specifications	
Limiting Element Voltage <sup>(1)</sup>	14V,18V	12.5 V	
	2HV	25 V	
	24V,28V,N8V,38V,34V,V4V,V8V	50 V	
	S8V	100 V	
Maximum Overload Voltage <sup>(2)</sup>	14V,18V	25 V	
	2HV	50 V	
	24V,28V,N8V,38V,34V,V4V,V8V	100 V	
	S8V	200 V	
T.C.R.		±200×10 <sup>-6</sup> /°C	
Category Temperature Range		-55 °C to 125 °C	
Jumper Array	Rated Current	14V,18V	0.5 A
		2HV,24V,28V,N8V,38V,34V,V4V,V8V	1 A
		S8V	2 A
	Maximum Overload Current	14V,18V	1 A
		2HV,24V,28V,N8V,38V,34V,V4V,V8V	2 A
S8V		4 A	

(1) Rated Continuous Working Voltage (RCWV) shall be determined from  $RCWV = \sqrt{\text{Power Rating} \times \text{Resistance Value}}$ , or Limiting Element Voltage listed above, whichever less.

(2) Overload (Short-time Overload) Test Voltage (SOTV) shall be determined from  $SOTV = 2.5 \times \text{Power Rating}$  or max. Overload Voltage listed above whichever less.

### Power Derating Curve

For resistors operated in ambient temperature above 70 °C, power rating shall be derated in accordance with the figure on the right.

