

ON Semiconductor

Is Now

onsemi™

To learn more about onsemi™, please visit our website at
www.onsemi.com

onsemi and **onsemi** and other names, marks, and brands are registered and/or common law trademarks of Semiconductor Components Industries, LLC dba "**onsemi**" or its affiliates and/or subsidiaries in the United States and/or other countries. **onsemi** owns the rights to a number of patents, trademarks, copyrights, trade secrets, and other intellectual property. A listing of **onsemi** product/patent coverage may be accessed at www.onsemi.com/site/pdf/Patent-Marking.pdf. **onsemi** reserves the right to make changes at any time to any products or information herein, without notice. The information herein is provided "as-is" and **onsemi** makes no warranty, representation or guarantee regarding the accuracy of the information, product features, availability, functionality, or suitability of its products for any particular purpose, nor does **onsemi** assume any liability arising out of the application or use of any product or circuit, and specifically disclaims any and all liability, including without limitation special, consequential or incidental damages. Buyer is responsible for its products and applications using **onsemi** products, including compliance with all laws, regulations and safety requirements or standards, regardless of any support or applications information provided by **onsemi**. "Typical" parameters which may be provided in **onsemi** data sheets and/or specifications can and do vary in different applications and actual performance may vary over time. All operating parameters, including "Typicals" must be validated for each customer application by customer's technical experts. **onsemi** does not convey any license under any of its intellectual property rights nor the rights of others. **onsemi** products are not designed, intended, or authorized for use as a critical component in life support systems or any FDA Class 3 medical devices or medical devices with a same or similar classification in a foreign jurisdiction or any devices intended for implantation in the human body. Should Buyer purchase or use **onsemi** products for any such unintended or unauthorized application, Buyer shall indemnify and hold **onsemi** and its officers, employees, subsidiaries, affiliates, and distributors harmless against all claims, costs, damages, and expenses, and reasonable attorney fees arising out of, directly or indirectly, any claim of personal injury or death associated with such unintended or unauthorized use, even if such claim alleges that **onsemi** was negligent regarding the design or manufacture of the part. **onsemi** is an Equal Opportunity/Affirmative Action Employer. This literature is subject to all applicable copyright laws and is not for resale in any manner. Other names and brands may be claimed as the property of others.

Triple Inverter

NL37WZ04

The NL37WZ04 is a high performance triple inverter operating from a 1.65 V to 5.5 V supply.

Features

- Designed for 1.65 V to 5.5 V V_{CC} Operation
- 2.3 ns t_{PD} at $V_{CC} = 5$ V (Typ)
- Inputs/Outputs Overvoltage Tolerant up to 5.5 V
- I_{OFF} Supports Partial Power Down Protection
- Source/Sink 24 mA at 3.0 V
- Available in US8, UDFN8 and UQFN8 Packages
- Chip Complexity < 100 FETs
- NLV Prefix for Automotive and Other Applications Requiring Unique Site and Control Change Requirements; AEC-Q100 Qualified and PPAP Capable
- These Devices are Pb-Free, Halogen Free/BFR Free and are RoHS Compliant

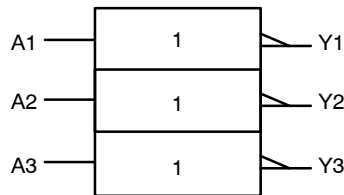

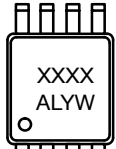

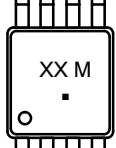

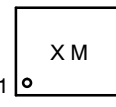

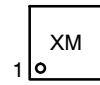

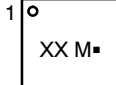

Figure 1. Logic Symbol



ON Semiconductor®

www.onsemi.com

| | | MARKING DIAGRAMS |
|---|--|---|
|  | US8 US SUFFIX CASE 493 |  Commercial |
|  | UDFN8, 1.45x1.0 MU3 SUFFIX CASE 517BZ |  NLV Prefix |
|  | UDFN8, 1.95x1.0 MU1 SUFFIX CASE 517CA |  |
|  | UQFN8, 1.4x1.2 MQ2 SUFFIX CASE 523AS |  |
|  | UQFN8, 1.6x1.6 MQ1 SUFFIX CASE 523AN |  |
| X, XX, XXXX = Specific Device Code A = Assembly Location L = Lot Code Y = Year Code W = Week Code M = Date Code ■ = Pb-Free Package | | |

ORDERING INFORMATION

See detailed ordering, marking and shipping information in the package dimensions section on page 6 of this data sheet.

NL37WZ04

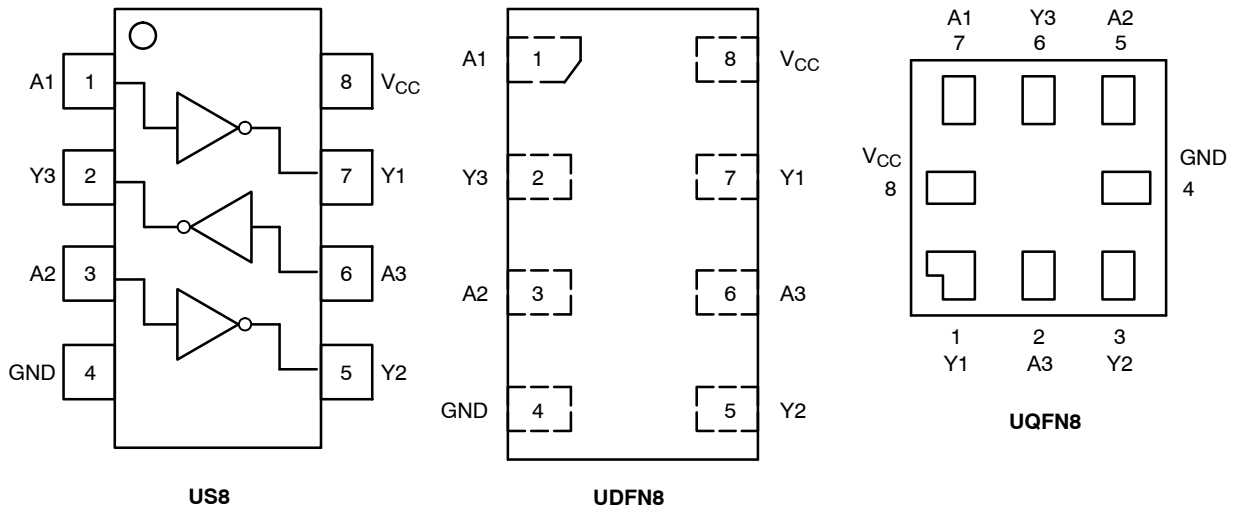

Figure 2. Pinout

PIN ASSIGNMENT

| Pin | US8 / UDFN8 | UQFN8 |
|-----|-----------------|-----------------|
| 1 | A1 | Y1 |
| 2 | Y3 | A3 |
| 3 | A2 | Y2 |
| 4 | GND | GND |
| 5 | Y2 | A2 |
| 6 | A3 | Y3 |
| 7 | Y1 | A1 |
| 8 | V _{CC} | V _{CC} |

FUNCTION TABLE

| A Input | Y Output |
|---------|----------|
| L | H |
| H | L |

NL37WZ04

MAXIMUM RATINGS

| Symbol | Characteristics | Value | Unit |
|-------------------------------------|--|---|------|
| V _{CC} | DC Supply Voltage NLV | -0.5 to +7.0 -0.5 to +6.5 | V |
| V _{IN} | DC Input Voltage NLV | -0.5 to +7.0 -0.5 to +6.5 | V |
| V _{OUT} | DC Output Voltage (NLV) Active-Mode (High or Low State) Tri-State Mode (Note 1) Power-Down Mode (V _{CC} = 0 V) | -0.5 to V _{CC} + 0.5 -0.5 to +7.0 -0.5 to +7.0 | V |
| | DC Output Voltage Active-Mode (High or Low State) Tri-State Mode (Note 1) Power-Down Mode (V _{CC} = 0 V) | -0.5 to V _{CC} + 0.5 -0.5 to +6.5 -0.5 to +6.5 | V |
| I _{IK} | DC Input Diode Current V _{IN} < GND | -50 | mA |
| I _{OK} | DC Output Diode Current V _{OUT} < GND | -50 | mA |
| I _{OUT} | DC Output Source/Sink Current | ±50 | mA |
| I _{CC} or I _{GND} | DC Supply Current per Supply Pin or Ground Pin | ±100 | mA |
| T _{STG} | Storage Temperature Range | -65 to +150 | °C |
| T _L | Lead Temperature, 1 mm from Case for 10 secs | 260 | °C |
| T _J | Junction Temperature Under Bias | +150 | °C |
| θ _{JA} | Thermal Resistance (Note 2) | US8 UQFN8 UDFN8 250 210 231 | °C/W |
| P _D | Power Dissipation in Still Air | US8 UQFN8 UDFN8 500 595 541 | mW |
| MSL | Moisture Sensitivity | Level 1 | - |
| F _R | Flammability Rating Oxygen Index: 28 to 34 | UL 94 V-0 @ 0.125 in | - |
| V _{ESD} | ESD Withstand Voltage (Note 3) Human Body Model Charged Device Model | 2000 1000 | V |
| I _{Latchup} | Latchup Performance (Note 4) | ±100 | mA |

Stresses exceeding those listed in the Maximum Ratings table may damage the device. If any of these limits are exceeded, device functionality should not be assumed, damage may occur and reliability may be affected.

1. Applicable to devices with outputs that may be tri-stated.
2. Measured with minimum pad spacing on an FR4 board, using 10mm-by-1inch, 2 ounce copper trace no air flow per JESD51-7.
3. HBM tested to ANSI/ESDA/JEDEC JS-001-2017. CDM tested to EIA/JESD22-C101-F. JEDEC recommends that ESD qualification to EIA/JESD22-A115-A (Machine Model) be discontinued per JEDEC/JEP172A.
4. Tested to EIA/JESD78 Class II.

RECOMMENDED OPERATING CONDITIONS

| Symbol | Characteristics | Min | Max | Unit |
|---------------------------------|--|------|-----------------|------|
| V _{CC} | Positive DC Supply Voltage | 1.65 | 5.5 | V |
| V _{IN} | DC Input Voltage | 0 | 5.5 | V |
| V _{OUT} | DC Output Voltage Active-Mode (High or Low State) Tri-State Mode (Note 1) Power-Down Mode (V _{CC} = 0 V) | 0 | V _{CC} | |
| | | 0 | 5.5 | |
| | | 0 | 5.5 | |
| T _A | Operating Temperature Range | -55 | +125 | °C |
| t _r , t _f | Input Rise and Fall Time (NLV) V _{CC} = 3.0 V to 3.6 V V _{CC} = 4.5 V to 5.5 V | 0 | 100 | ns/V |
| | | 0 | 20 | |
| | Input Rise and Fall Time V _{CC} = 1.65 V to 1.95 V V _{CC} = 2.3 V to 2.7 V V _{CC} = 3.0 V to 3.6 V V _{CC} = 4.5 V to 5.5 V | 0 | 20 | |
| | | 0 | 10 | |
| | | 0 | 5 | |

Functional operation above the stresses listed in the Recommended Operating Ranges is not implied. Extended exposure to stresses beyond the Recommended Operating Ranges limits may affect device reliability.

DC ELECTRICAL CHARACTERISTICS

| Symbol | Parameter | Condition | V _{CC} (V) | T _A = 25°C | | | -55°C ≤ T _A ≤ 125°C | | Units |
|------------------|---------------------------|---|---------------------|-----------------------|-----------------|----------------------|--------------------------------|----------------------|-------|
| | | | | Min | Typ | Max | Min | Max | |
| V _{IH} | High-Level Input Voltage | | 1.65 to 1.95 | 0.65 V _{CC} | - | - | 0.65 V _{CC} | - | V |
| | | | 2.3 to 5.5 | 0.70 V _{CC} | - | - | 0.70 V _{CC} | - | |
| V _{IL} | Low-Level Input Voltage | | 1.65 to 1.95 | - | - | 0.35 V _{CC} | - | 0.35 V _{CC} | V |
| | | | 2.3 to 5.5 | - | - | 0.30 V _{CC} | - | 0.30 V _{CC} | |
| V _{OH} | High-Level Output Voltage | V _{IN} = V _{IH} or V _{IL} I _{OH} = -100 μA I _{OH} = -4 mA I _{OH} = -8 mA I _{OH} = -12 mA I _{OH} = -16 mA I _{OH} = -24 mA I _{OH} = -32 mA | 1.65 to 5.5 | V _{CC} - 0.1 | V _{CC} | - | V _{CC} - 0.1 | - | V |
| | | | 1.65 | 1.29 | 1.4 | - | 1.29 | - | |
| | | | 2.3 | 1.9 | 2.1 | - | 1.9 | - | |
| | | | 2.7 | 2.2 | 2.4 | - | 2.2 | - | |
| | | | 3.0 | 2.4 | 2.7 | - | 2.4 | - | |
| | | | 3.0 | 2.3 | 2.5 | - | 2.3 | - | |
| | | | 4.5 | 3.8 | 4.0 | - | 3.8 | - | |
| V _{OL} | Low-Level Output Voltage | V _{IN} = V _{IH} or V _{IL} I _{OL} = 100 μA I _{OL} = 4 mA I _{OL} = 8 mA I _{OL} = 12 mA I _{OL} = 16 mA I _{OL} = 24 mA I _{OL} = 32 mA | 1.65 to 5.5 | - | - | 0.1 | - | 0.1 | V |
| | | | 1.65 | - | 0.08 | 0.24 | - | 0.24 | |
| | | | 2.3 | - | 0.2 | 0.3 | - | 0.3 | |
| | | | 2.7 | - | 0.22 | 0.4 | - | 0.4 | |
| | | | 3.0 | - | 0.28 | 0.4 | - | 0.4 | |
| | | | 3.0 | - | 0.38 | 0.55 | - | 0.55 | |
| | | | 4.5 | - | 0.42 | 0.55 | - | 0.55 | |
| I _{IN} | Input Leakage Current | V _{IN} = 5.5 V or GND | 1.65 to 5.5 | - | - | ±0.1 | - | ±1.0 | μA |
| I _{OFF} | Power Off Leakage Current | V _{IN} = 5.5 V or V _{OUT} = 5.5 V | 0 | - | - | 1.0 | - | 10 | μA |
| I _{CC} | Quiescent Supply Current | V _{IN} = V _{CC} or GND | 5.5 | - | - | 1.0 | - | 10 | μA |

Product parametric performance is indicated in the Electrical Characteristics for the listed test conditions, unless otherwise noted. Product performance may not be indicated by the Electrical Characteristics if operated under different conditions.

AC ELECTRICAL CHARACTERISTICS

| Symbol | Parameter | V _{CC} (V) | Test Conditions | T _A = 25°C | | | T _A = -55 to 125°C | | Units |
|--|------------------------------|---------------------|--|--|-----|-----|-------------------------------|------|-------|
| | | | | Min | Typ | Max | Min | Max | |
| t _{PLH} , t _{PHL} | Propagation Delay, A to Y | 1.65 to 1.95 | C _L = 15 pF R _L = 1 MΩ R ₁ = Open | - | 4.4 | 9.5 | - | 10.0 | ns |
| | | 2.3 to 2.7 | | - | 5.0 | 5.7 | - | 6.1 | |
| | | 3.0 to 3.6 | | - | 2.2 | 3.4 | - | 3.8 | |
| | | 4.5 to 5.5 | | - | 1.8 | 2.8 | - | 3.1 | |
| | | 3.0 to 3.6 | | C _L = 50 pF, R _L = 500 Ω, R ₁ = Open | - | 3.9 | 4.5 | - | |
| | | 4.5 to 5.5 | - | | 2.3 | 3.6 | - | 4.0 | |

5. C_{PD} is defined as the value of the internal equivalent capacitance which is calculated from the operating current consumption without load. Average operating current can be obtained by the equation: I_{CC(OPR)} = C_{PD} • V_{CC} • f_{in} + I_{CC}/2 (per flip-flop). C_{PD} is used to determine the no-load dynamic power consumption; P_D = C_{PD} • V_{CC}² • f_{in} + I_{CC} • V_{CC}.

CAPACITIVE CHARACTERISTICS

| Symbol | Parameter | Condition | Typical | Units |
|------------------|---|---|---------|-------|
| C _{IN} | Input Capacitance | V _{CC} = 5.5 V, V _{IN} = 0 V or V _{CC} | 2.5 | pF |
| C _{OUT} | Output Capacitance | V _{CC} = 5.5 V, V _{IN} = 0 V or V _{CC} | 2.5 | pF |
| C _{PD} | Power Dissipation Capacitance (Note 6) | 10 MHz, V _{CC} = 3.3 V, V _{IN} = 0 V or V _{CC} | 9 | pF |
| | | 10 MHz, V _{CC} = 5.5 V, V _{IN} = 0 V or V _{CC} | 11 | |

6. C_{PD} is defined as the value of the internal equivalent capacitance which is calculated from the operating current consumption without load. Average operating current can be obtained by the equation: I_{CC(OPR)} = C_{PD} • V_{CC} • f_{in} + I_{CC}. C_{PD} is used to determine the no-load dynamic power consumption; P_D = C_{PD} • V_{CC}² • f_{in} + I_{CC} • V_{CC}.

NL37WZ04



C_L includes probe and jig capacitance
 R_T is Z_{OUT} of pulse generator (typically 50 Ω)
 $f = 1$ MHz

Figure 3. Test Circuit

| Test | Switch Position | C_L , pF | R_L , Ω | R_1 , Ω |
|---------------------|-------------------|------------------------------|------------------|------------------|
| t_{PLH} / t_{PHL} | Open | See AC Characteristics Table | | |
| t_{PLZ} / t_{PZL} | $2 \times V_{CC}$ | 50 | 500 | 500 |
| t_{PHZ} / t_{PZH} | GND | 50 | 500 | 500 |

X = Don't Care



Figure 4. Switching Waveforms

| V_{CC} , V | V_{mi} , V | V_{mo} , V | | V_Y , V |
|--------------|--------------|-----------------------|---|-----------|
| | | t_{PLH} , t_{PHL} | t_{PZL} , t_{PLZ} , t_{PZH} , t_{PHZ} | |
| 1.65 to 1.95 | $V_{CC}/2$ | $V_{CC}/2$ | $V_{CC}/2$ | 0.15 |
| 2.3 to 2.7 | $V_{CC}/2$ | $V_{CC}/2$ | $V_{CC}/2$ | 0.15 |
| 3.0 to 3.6 | $V_{CC}/2$ | $V_{CC}/2$ | $V_{CC}/2$ | 0.3 |
| 4.5 to 5.5 | $V_{CC}/2$ | $V_{CC}/2$ | $V_{CC}/2$ | 0.3 |

NL37WZ04

DEVICE ORDERING INFORMATION

| Device | Packages | Specific Device Code | Pin 1 Orientation (See below) | Shipping† |
|------------------------------------|--------------------------|----------------------|----------------------------------|--------------------|
| NL37WZ04USG | US8 | L5 | Q4 | 3000 / Tape & Reel |
| NLV37WZ04USG* | US8 | L5 | Q4 | 3000 / Tape & Reel |
| NL37WZ04MQ1TCG (In Development) | UQFN8, 1.6 x 1.6, 0.5P | TBD | TBD | 3000 / Tape & Reel |
| NL37WZ04MU1TCG (In Development) | UDFN8, 1.95 x 1.0, 0.5P | TBD | TBD | 3000 / Tape & Reel |
| NL37WZ04MU3TCG (In Development) | UDFN8, 1.45 x 1.0, 0.35P | TBD | TBD | 3000 / Tape & Reel |
| NL37WZ04MQ2TCG (In Development) | UQFN8, 1.4 x 1.2, 0.4P | TBD | TBD | 3000 / Tape & Reel |

†For information on tape and reel specifications, including part orientation and tape sizes, please refer to our Tape and Reel Packaging Specifications Brochure, BRD8011/D.

*NLV Prefix for Automotive and Other Applications Requiring Unique Site and Control Change Requirements; AEC-Q100 Qualified and PPAP Capable.

Pin 1 Orientation in Tape and Reel

Direction of Feed

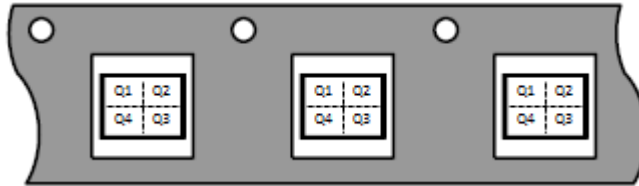

NL37WZ04

PACKAGE DIMENSIONS

US8
US SUFFIX
CASE 493-02
ISSUE B

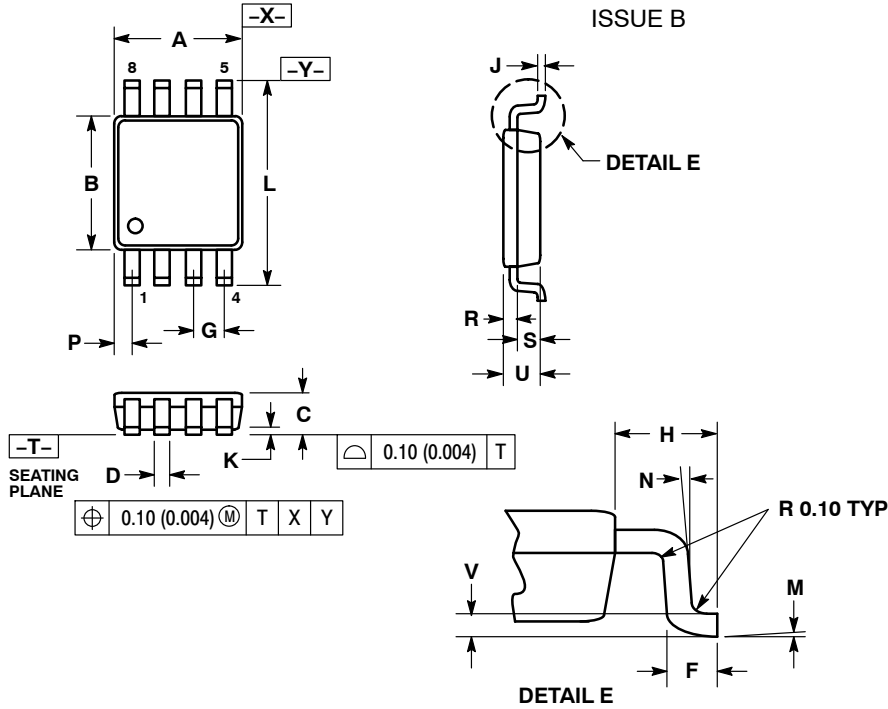

- NOTES:
1. DIMENSIONING AND TOLERANCING PER ANSI Y14.5M, 1982.
 2. CONTROLLING DIMENSION: MILLIMETERS.
 3. DIMENSION "A" DOES NOT INCLUDE MOLD FLASH, PROTRUSION OR GATE BURR. MOLD FLASH, PROTRUSION AND GATE BURR SHALL NOT EXCEED 0.140 MM (0.0055") PER SIDE.
 4. DIMENSION "B" DOES NOT INCLUDE INTER-LEAD FLASH OR PROTRUSION. INTER-LEAD FLASH AND PROTRUSION SHALL NOT EXCEED 0.140 (0.0055") PER SIDE.
 5. LEAD FINISH IS SOLDER PLATING WITH THICKNESS OF 0.0076-0.0203 MM. (300-800 °).
 6. ALL TOLERANCE UNLESS OTHERWISE SPECIFIED ±0.0508 (0.0002").

| DIM | MILLIMETERS | | INCHES | |
|-----|-------------|------|-----------|-------|
| | MIN | MAX | MIN | MAX |
| A | 1.90 | 2.10 | 0.075 | 0.083 |
| B | 2.20 | 2.40 | 0.087 | 0.094 |
| C | 0.60 | 0.90 | 0.024 | 0.035 |
| D | 0.17 | 0.25 | 0.007 | 0.010 |
| F | 0.20 | 0.35 | 0.008 | 0.014 |
| G | 0.50 BSC | | 0.020 BSC | |
| H | 0.40 REF | | 0.016 REF | |
| J | 0.10 | 0.18 | 0.004 | 0.007 |
| K | 0.00 | 0.10 | 0.000 | 0.004 |
| L | 3.00 | 3.20 | 0.118 | 0.126 |
| M | 0° | 6° | 0° | 6° |
| N | 5° | 10° | 5° | 10° |
| P | 0.23 | 0.34 | 0.010 | 0.013 |
| R | 0.23 | 0.33 | 0.009 | 0.013 |
| S | 0.37 | 0.47 | 0.015 | 0.019 |
| U | 0.60 | 0.80 | 0.024 | 0.031 |
| V | 0.12 BSC | | 0.005 BSC | |

SOLDERING FOOTPRINT*

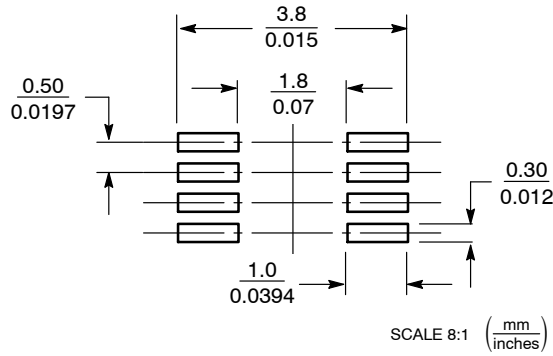

*For additional information on our Pb-Free strategy and soldering details, please download the ON Semiconductor Soldering and Mounting Techniques Reference Manual, SOLDERRM/D.

NL37WZ04

PACKAGE DIMENSIONS

UDFN8, 1.45x1, 0.35P
CASE 517BZ
ISSUE O

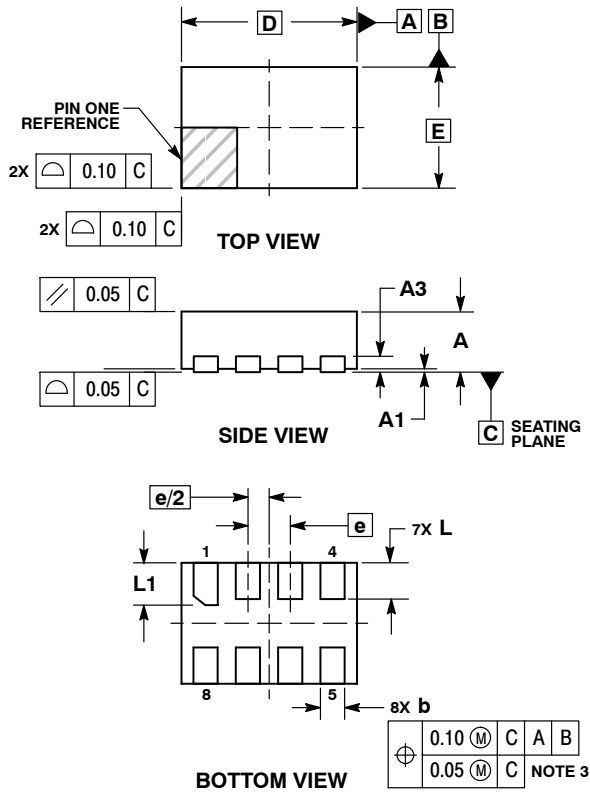

NOTES:

1. DIMENSIONING AND TOLERANCING PER ASME Y14.5M, 1994.
2. CONTROLLING DIMENSION: MILLIMETERS.
3. DIMENSION b APPLIES TO PLATED TERMINAL AND IS MEASURED BETWEEN 0.15 AND 0.20 MM FROM TERMINAL TIP.
4. PACKAGE DIMENSIONS EXCLUSIVE OF BURRS AND MOLD FLASH.

| MILLIMETERS | | |
|-------------|----------|------|
| DIM | MIN | MAX |
| A | 0.45 | 0.55 |
| A1 | 0.00 | 0.05 |
| A3 | 0.13 REF | |
| b | 0.15 | 0.25 |
| D | 1.45 BSC | |
| E | 1.00 BSC | |
| e | 0.35 BSC | |
| L | 0.25 | 0.35 |
| L1 | 0.30 | 0.40 |

RECOMMENDED SOLDERING FOOTPRINT*

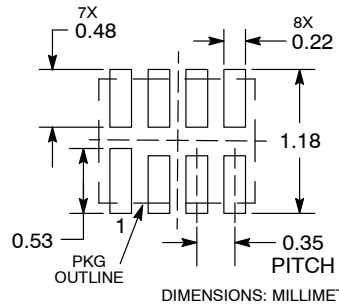

*For additional information on our Pb-Free strategy and soldering details, please download the ON Semiconductor Soldering and Mounting Techniques Reference Manual, SOLDERRM/D.

NL37WZ04

PACKAGE DIMENSIONS

UDFN8, 1.95x1, 0.5P
CASE 517CA
ISSUE O

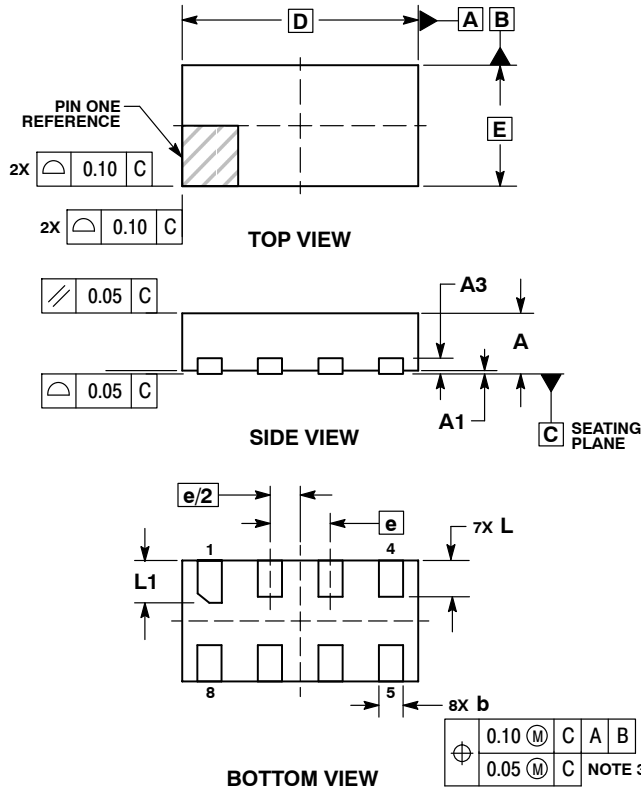

NOTES:

1. DIMENSIONING AND TOLERANCING PER ASME Y14.5M, 1994.
2. CONTROLLING DIMENSION: MILLIMETERS.
3. DIMENSION b APPLIES TO PLATED TERMINAL AND IS MEASURED BETWEEN 0.15 AND 0.20 MM FROM TERMINAL TIP.
4. PACKAGE DIMENSIONS EXCLUSIVE OF BURRS AND MOLD FLASH.

| MILLIMETERS | | |
|-------------|----------|------|
| DIM | MIN | MAX |
| A | 0.45 | 0.55 |
| A1 | 0.00 | 0.05 |
| A3 | 0.13 REF | |
| b | 0.15 | 0.25 |
| D | 1.95 BSC | |
| E | 1.00 BSC | |
| e | 0.50 BSC | |
| L | 0.25 | 0.35 |
| L1 | 0.30 | 0.40 |

RECOMMENDED SOLDERING FOOTPRINT*

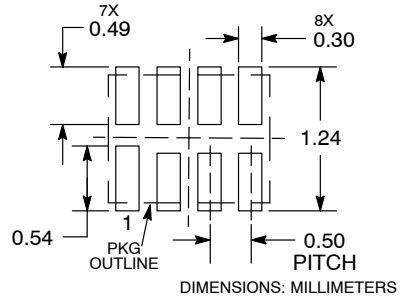

*For additional information on our Pb-Free strategy and soldering details, please download the ON Semiconductor Soldering and Mounting Techniques Reference Manual, SOLDERRM/D.

NL37WZ04

PACKAGE DIMENSIONS

UQFN8, 1.4x1.2, 0.4P
CASE 523AS
ISSUE A

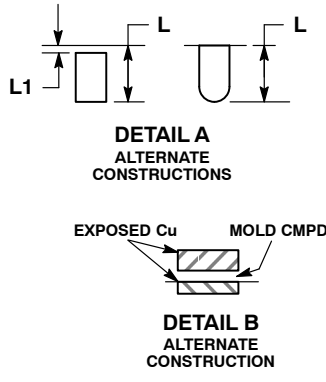
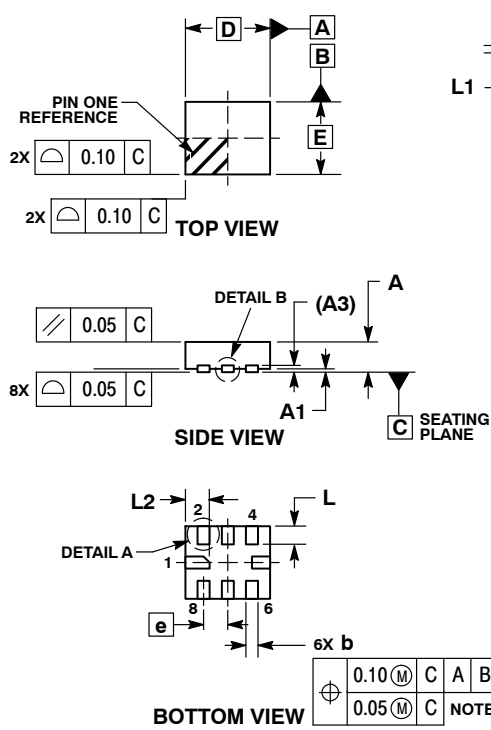

- NOTES:
1. DIMENSIONING AND TOLERANCING PER ASME Y14.5M, 1994.
 2. CONTROLLING DIMENSION: MILLIMETERS.
 3. DIMENSION b APPLIES TO PLATED TERMINAL AND IS MEASURED BETWEEN 0.15 AND 0.25 mm FROM THE TERMINAL TIP.

| MILLIMETERS | | |
|-------------|------|------|
| DIM | MIN | MAX |
| A | 0.45 | 0.55 |
| A1 | 0.00 | 0.05 |
| A3 | 0.13 | REF |
| b | 0.15 | 0.25 |
| D | 1.40 | BSC |
| E | 1.20 | BSC |
| e | 0.40 | BSC |
| L | 0.20 | 0.40 |
| L1 | --- | 0.15 |
| L2 | 0.30 | 0.50 |

SOLDERING FOOTPRINT*

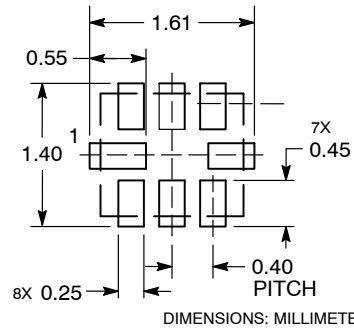

*For additional information on our Pb-Free strategy and soldering details, please download the ON Semiconductor Soldering and Mounting Techniques Reference Manual, SOLDERRM/D.

NL37WZ04

PACKAGE DIMENSIONS

UQFN8, 1.6x1.6, 0.5P CASE 523AN ISSUE O

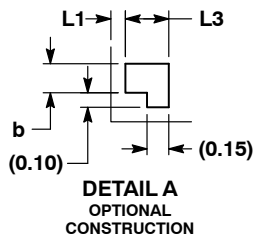
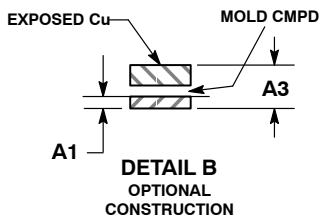
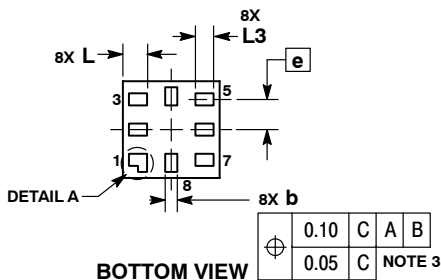
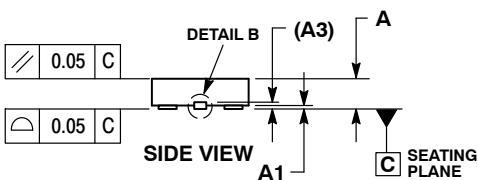
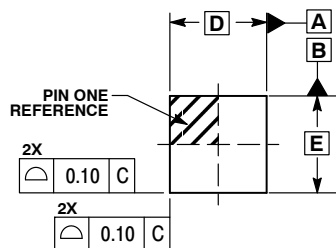

NOTES:

1. DIMENSIONING AND TOLERANCING PER ASME Y14.5M, 1994.
2. CONTROLLING DIMENSION: MILLIMETERS.
3. DIMENSION b APPLIES TO PLATED TERMINAL AND IS MEASURED BETWEEN 0.15 AND 0.30 mm FROM THE TERMINAL TIP.

| MILLIMETERS | | |
|-------------|------|------|
| DIM | MIN | MAX |
| A | 0.45 | 0.60 |
| A1 | 0.00 | 0.05 |
| A3 | 0.13 | REF |
| b | 0.15 | 0.25 |
| D | 1.60 | BSC |
| E | 1.60 | BSC |
| e | 0.50 | BSC |
| L | 0.35 | 0.45 |
| L1 | --- | 0.15 |
| L3 | 0.25 | 0.35 |

SOLDERING FOOTPRINT*

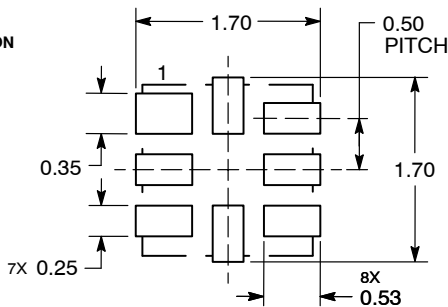

*For additional information on our Pb-Free strategy and soldering details, please download the ON Semiconductor Soldering and Mounting Techniques Reference Manual, SOLDERRM/D.

ON Semiconductor and are trademarks of Semiconductor Components Industries, LLC dba ON Semiconductor or its subsidiaries in the United States and/or other countries. ON Semiconductor owns the rights to a number of patents, trademarks, copyrights, trade secrets, and other intellectual property. A listing of ON Semiconductor's product/patent coverage may be accessed at www.onsemi.com/site/pdf/Patent-Marking.pdf. ON Semiconductor reserves the right to make changes without further notice to any products herein. ON Semiconductor makes no warranty, representation or guarantee regarding the suitability of its products for any particular purpose, nor does ON Semiconductor assume any liability arising out of the application or use of any product or circuit, and specifically disclaims any and all liability, including without limitation special, consequential or incidental damages. Buyer is responsible for its products and applications using ON Semiconductor products, including compliance with all laws, regulations and safety requirements or standards, regardless of any support or applications information provided by ON Semiconductor. "Typical" parameters which may be provided in ON Semiconductor data sheets and/or specifications can and do vary in different applications and actual performance may vary over time. All operating parameters, including "Typicals" must be validated for each customer application by customer's technical experts. ON Semiconductor does not convey any license under its patent rights nor the rights of others. ON Semiconductor products are not designed, intended, or authorized for use as a critical component in life support systems or any FDA Class 3 medical devices or medical devices with a same or similar classification in a foreign jurisdiction or any devices intended for implantation in the human body. Should Buyer purchase or use ON Semiconductor products for any such unintended or unauthorized application, Buyer shall indemnify and hold ON Semiconductor and its officers, employees, subsidiaries, affiliates, and distributors harmless against all claims, costs, damages, and expenses, and reasonable attorney fees arising out of, directly or indirectly, any claim of personal injury or death associated with such unintended or unauthorized use, even if such claim alleges that ON Semiconductor was negligent regarding the design or manufacture of the part. ON Semiconductor is an Equal Opportunity/Affirmative Action Employer. This literature is subject to all applicable copyright laws and is not for resale in any manner.

PUBLICATION ORDERING INFORMATION

LITERATURE FULFILLMENT:
Email Requests to: orderlit@onsemi.com

TECHNICAL SUPPORT
North American Technical Support:
Voice Mail: 1 800-282-9855 Toll Free USA/Canada
Phone: 011 421 33 790 2910

Europe, Middle East and Africa Technical Support:
Phone: 00421 33 790 2910
For additional information, please contact your local Sales Representative

Mouser Electronics

Authorized Distributor

Click to View Pricing, Inventory, Delivery & Lifecycle Information:

[onsemi:](#)

[NL37WZ04US](#) [NL37WZ04USG](#) [NLV37WZ04USG](#)