

TIP110, TIP111, TIP112 (NPN); TIP115, TIP116, TIP117 (PNP)

TIP111, TIP112, TIP116, and TIP117 are Preferred Devices

Plastic Medium-Power Complementary Silicon Transistors

Designed for general-purpose amplifier and low-speed switching applications.

Features

- High DC Current Gain -
 $h_{FE} = 2500$ (Typ) @ I_C
= 1.0 Adc
- Collector-Emitter Sustaining Voltage - @ 30 mAdc
 $V_{CEO(sus)} = 60$ Vdc (Min) - TIP110, TIP115
= 80 Vdc (Min) - TIP111, TIP116
= 100 Vdc (Min) - TIP112, TIP117
- Low Collector-Emitter Saturation Voltage -
 $V_{CE(sat)} = 2.5$ Vdc (Max) @ I_C
= 2.0 Adc
- Monolithic Construction with Built-in Base-Emitter Shunt Resistors
- Pb-Free Packages are Available*



ON Semiconductor®

<http://onsemi.com>

DARLINGTON 2 AMPERE COMPLEMENTARY SILICON POWER TRANSISTORS 60-80-100 VOLTS, 50 WATTS

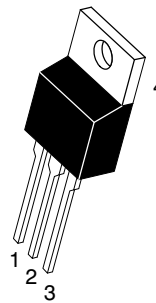

MARKING DIAGRAM



TO-220AB
CASE 221A
STYLE 1

TIP11x = Device Code
x = 0, 1, 2, 5, 6, or 7
A = Assembly Location
Y = Year
WW = Work Week
G = Pb-Free Package

ORDERING INFORMATION

See detailed ordering and shipping information in the package dimensions section on page 2 of this data sheet.

Preferred devices are recommended choices for future use and best overall value.

*For additional information on our Pb-Free strategy and soldering details, please download the ON Semiconductor Soldering and Mounting Techniques Reference Manual, SOLDERRM/D.

TIP110, TIP111, TIP112 (NPN); TIP115, TIP116, TIP117 (PNP)

MAXIMUM RATINGS

Rating	Symbol	TIP110, TIP115	TIP111, TIP116	TIP112, TIP117	Unit
Collector-Emitter Voltage	V_{CEO}	60	80	100	Vdc
Collector-Base Voltage	V_{CB}	60	80	100	Vdc
Emitter-Base Voltage	V_{EB}	5.0			Vdc
Collector Current - Continuous - Peak	I_C	2.0 4.0			Adc
Base Current	I_B	50			mAdc
Total Power Dissipation @ $T_C = 25^\circ\text{C}$ Derate above 25°C	P_D	50 0.4			W W/ $^\circ\text{C}$
Total Power Dissipation @ $T_A = 25^\circ\text{C}$ Derate above 25°C	P_D	2.0 0.016			W W/ $^\circ\text{C}$
Unclamped Inductive Load Energy - Figure 13	E	25			mJ
Operating and Storage Junction	T_J, T_{stg}	-65 to +150			$^\circ\text{C}$

THERMAL CHARACTERISTICS

Characteristics	Symbol	Max	Unit
Thermal Resistance, Junction-to-Case	$R_{\theta JC}$	2.5	$^\circ\text{C}/\text{W}$
Thermal Resistance, Junction-to-Ambient	$R_{\theta JA}$	62.5	$^\circ\text{C}/\text{W}$

Stresses exceeding Maximum Ratings may damage the device. Maximum Ratings are stress ratings only. Functional operation above the Recommended Operating Conditions is not implied. Extended exposure to stresses above the Recommended Operating Conditions may affect device reliability.

ORDERING INFORMATION

Device	Package	Shipping
TIP110	TO-220	50 Units / Rail
TIP110G	TO-220 (Pb-Free)	50 Units / Rail
TIP111	TO-220	50 Units / Rail
TIP111G	TO-220 (Pb-Free)	50 Units / Rail
TIP112	TO-220	50 Units / Rail
TIP112G	TO-220 (Pb-Free)	50 Units / Rail
TIP115	TO-220	50 Units / Rail
TIP115G	TO-220 (Pb-Free)	50 Units / Rail
TIP116	TO-220	50 Units / Rail
TIP116G	TO-220 (Pb-Free)	50 Units / Rail
TIP117	TO-220	50 Units / Rail
TIP117G	TO-220 (Pb-Free)	50 Units / Rail

TIP110, TIP111, TIP112 (NPN); TIP115, TIP116, TIP117 (PNP)

ELECTRICAL CHARACTERISTICS ($T_C = 25^\circ\text{C}$ unless otherwise noted)

Characteristic	Symbol	Min	Max	Unit
OFF CHARACTERISTICS				
Collector-Emitter Sustaining Voltage (Note 1) ($I_C = 30\text{ mA}$, $I_B = 0$)	$V_{CE(sus)}$	60 80 100	- - -	Vdc
Collector Cutoff Current ($V_{CE} = 30\text{ Vdc}$, $I_B = 0$) ($V_{CE} = 40\text{ Vdc}$, $I_B = 0$) ($V_{CE} = 50\text{ Vdc}$, $I_B = 0$)	I_{CEO}	- - -	2.0 2.0 2.0	mAdc
Collector Cutoff Current ($V_{CB} = 60\text{ Vdc}$, $I_E = 0$) ($V_{CB} = 80\text{ Vdc}$, $I_E = 0$) ($V_{CB} = 100\text{ Vdc}$, $I_E = 0$)	I_{CBO}	- - -	1.0 1.0 1.0	mAdc
Emitter Cutoff Current ($V_{BE} = 5.0\text{ Vdc}$, $I_C = 0$)	I_{EBO}	-	2.0	mAdc

ON CHARACTERISTICS (Note 1)

DC Current Gain ($I_C = 1.0\text{ Adc}$, $V_{CE} = 4.0\text{ Vdc}$) ($I_C = 2.0\text{ Adc}$, $V_{CE} = 4.0\text{ Vdc}$)	h_{FE}	1000 500	- -	-
Collector-Emitter Saturation Voltage ($I_C = 2.0\text{ Adc}$, $I_B = 8.0\text{ mA}$)	$V_{CE(sat)}$	-	2.5	Vdc
Base-Emitter On Voltage ($I_C = 2.0\text{ Adc}$, $V_{CE} = 4.0\text{ Vdc}$)	$V_{BE(on)}$	-	2.8	Vdc

DYNAMIC CHARACTERISTICS

Small-Signal Current Gain ($I_C = 0.75\text{ Adc}$, $V_{CE} = 10\text{ Vdc}$, $f = 1.0\text{ MHz}$)	h_{fe}	25	-	-
Output Capacitance ($V_{CB} = 10\text{ Vdc}$, $I_E = 0$, $f = 0.1\text{ MHz}$)	C_{ob}	- -	200 100	pF

1. Pulse Test: Pulse Width $\leq 300\ \mu\text{s}$, Duty Cycle $\leq 2\%$.

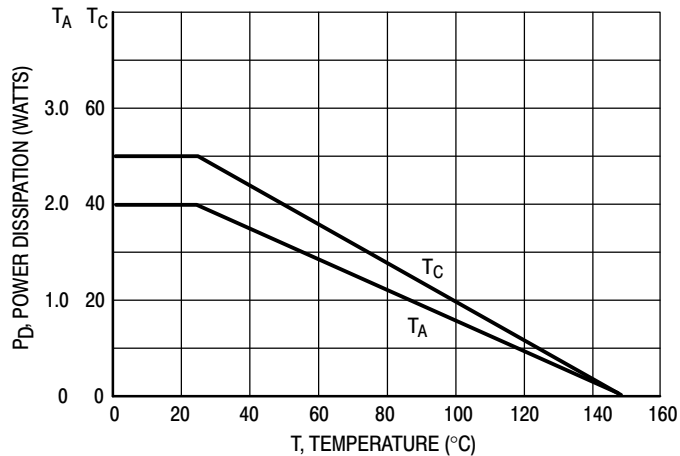

Figure 1. Power Derating

TIP110, TIP111, TIP112 (NPN); TIP115, TIP116, TIP117 (PNP)

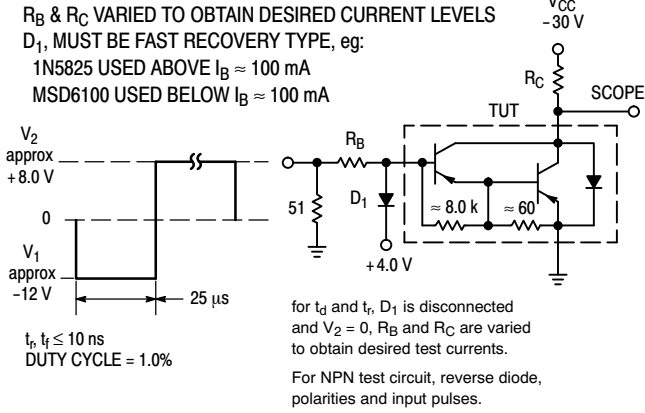

Figure 2. Switching Times Test Circuit

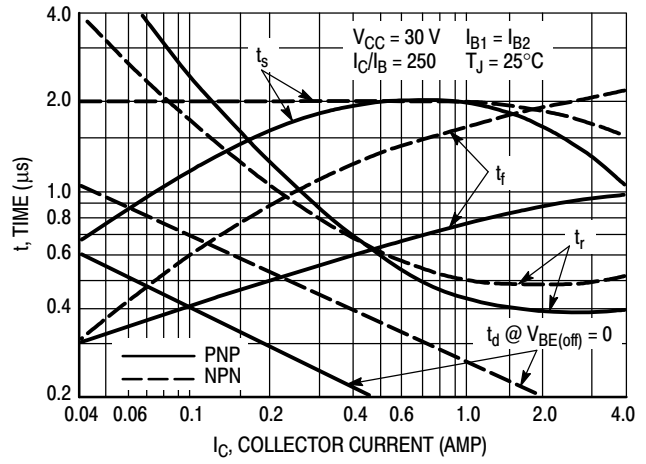

Figure 3. Switching Times

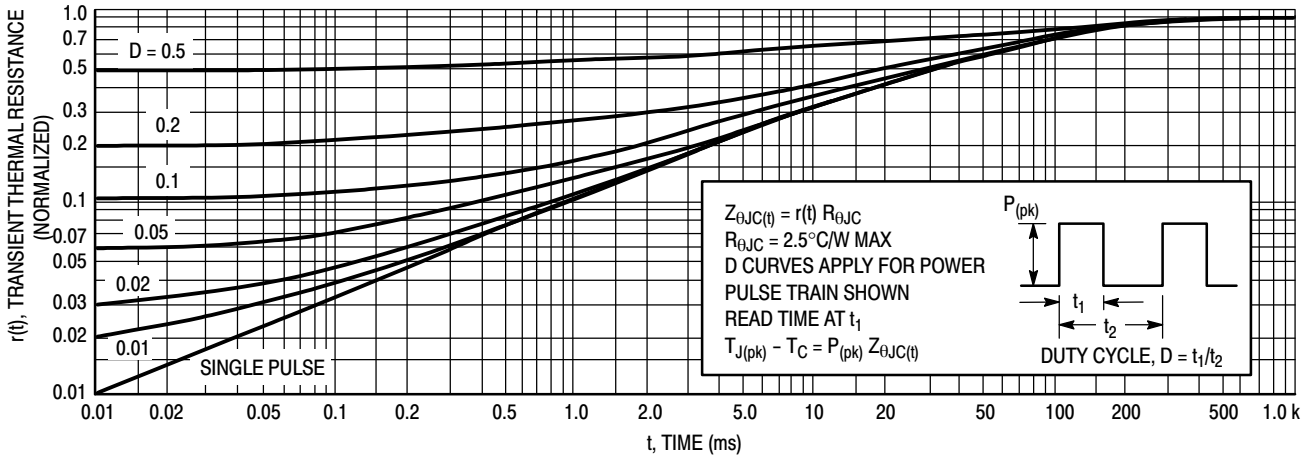

Figure 4. Thermal Response

TIP110, TIP111, TIP112 (NPN); TIP115, TIP116, TIP117 (PNP)

ACTIVE-REGION SAFE-OPERATING AREA

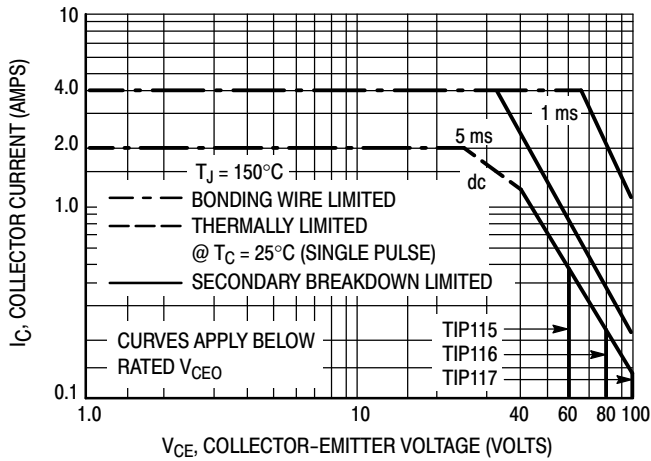

Figure 5. TIP115, 116, 117

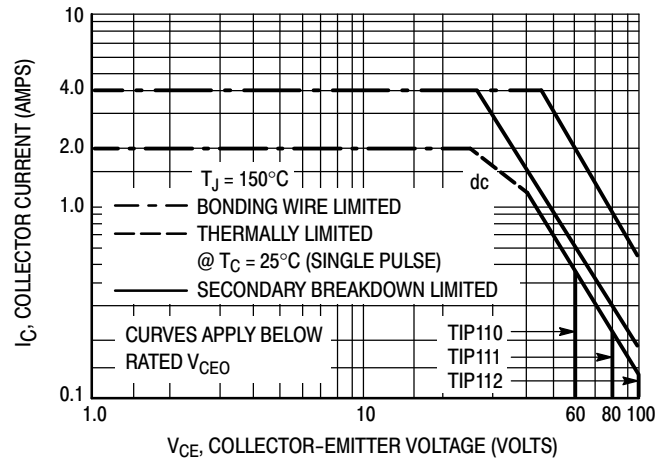

Figure 6. TIP110, 111, 112

There are two limitations on the power handling ability of a transistor: average junction temperature and second breakdown. Safe operating area curves indicate $I_C - V_{CE}$ limits of the transistor that must be observed for reliable operation; i.e., the transistor must not be subjected to greater dissipation than the curves indicate.

The data of Figures 5 and 6 is based on $T_{J(pk)} = 150^\circ\text{C}$; T_C is variable depending on conditions. Second breakdown pulse limits are valid for duty cycles to 10% provided $T_{J(pk)} < 150^\circ\text{C}$. $T_{J(pk)}$ may be calculated from the data in Figure 4. At high case temperatures, thermal limitations will reduce the power that can be handled to values less than the limitations imposed by second breakdown.

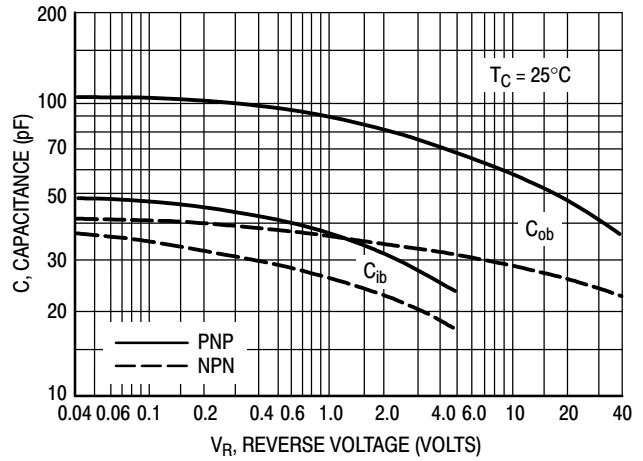

Figure 7. Capacitance

TIP110, TIP111, TIP112 (NPN); TIP115, TIP116, TIP117 (PNP)

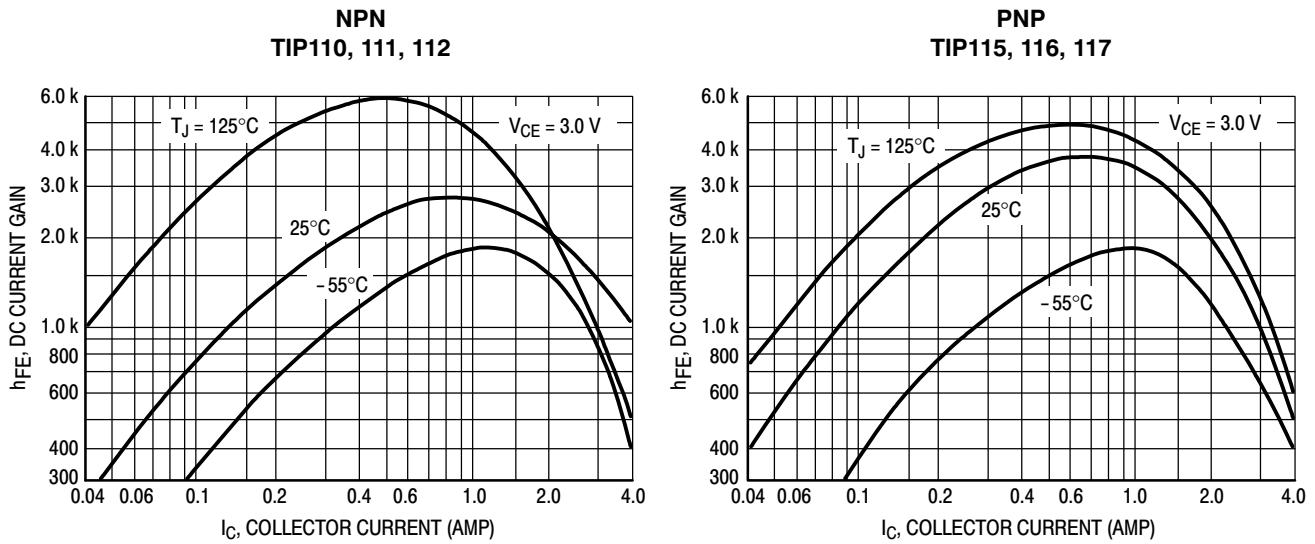

Figure 8. DC Current Gain

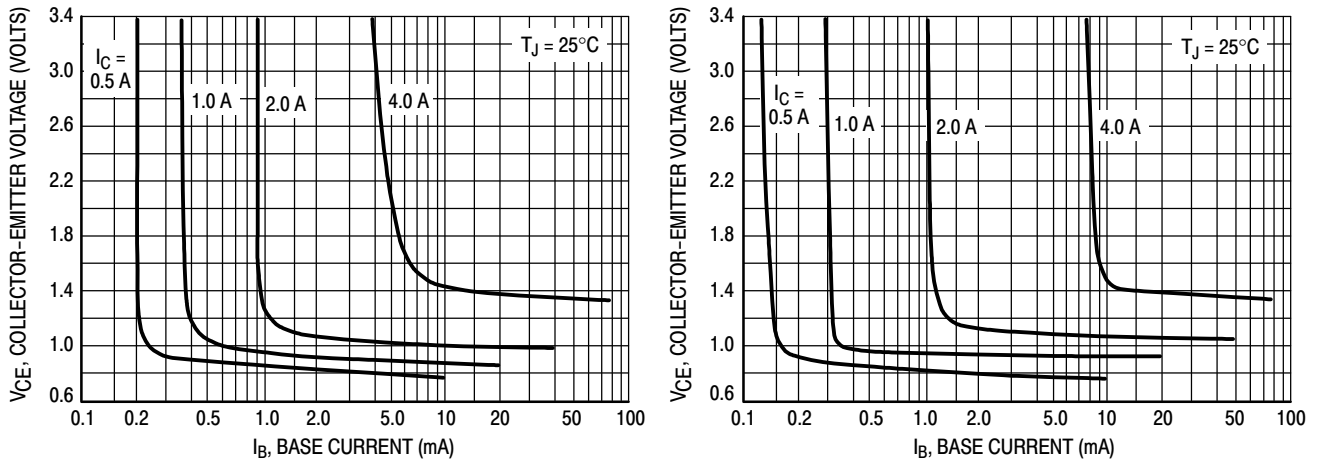

Figure 9. Collector Saturation Region

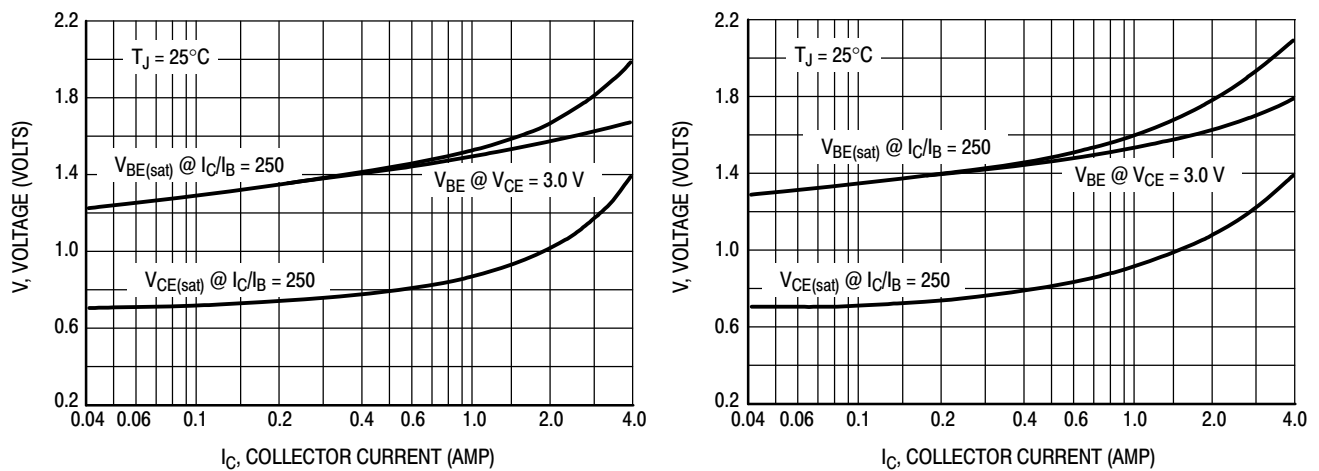

Figure 10. "On" Voltages

TIP110, TIP111, TIP112 (NPN); TIP115, TIP116, TIP117 (PNP)

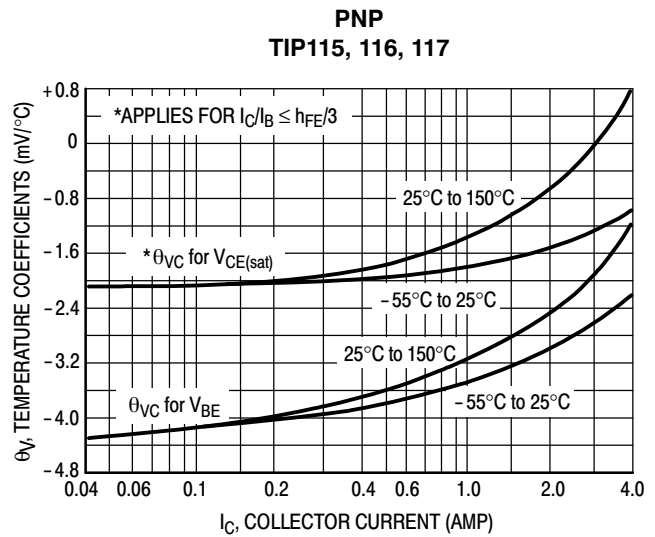
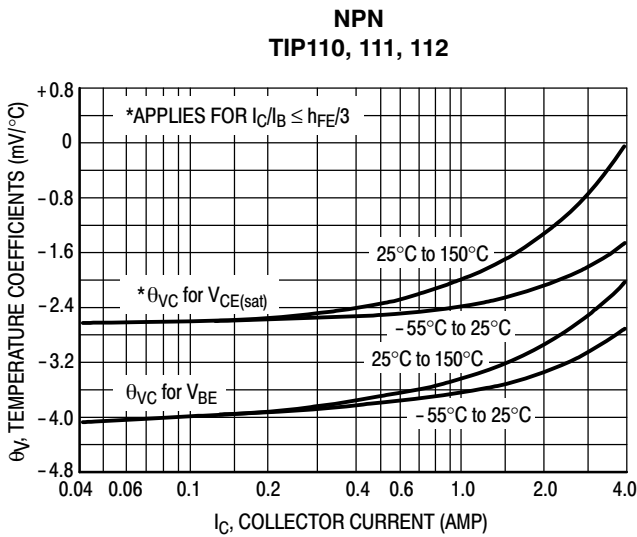

Figure 11. Temperature Coefficients

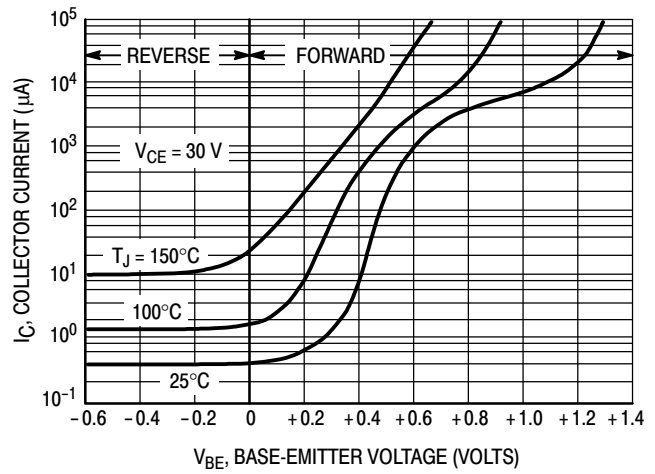
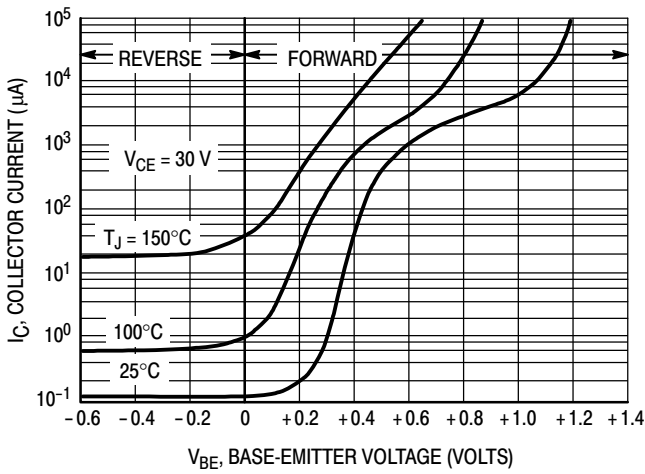
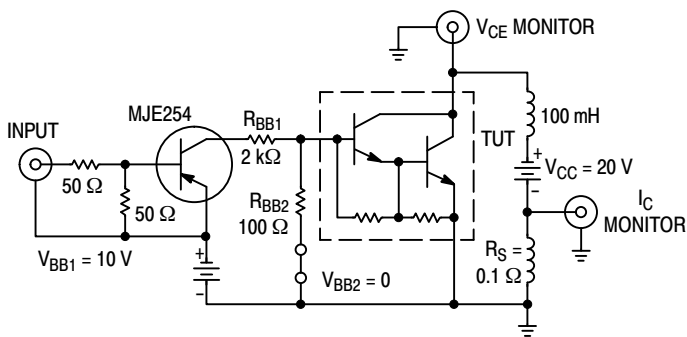

Figure 12. Collector Cut-Off Region

TEST CIRCUIT



Note A: Input pulse width is increased until $I_{CM} = 0.71$ A, NPN test shown; for PNP test reverse all polarity and use MJE224 driver.

VOLTAGE AND CURRENT WAVEFORMS

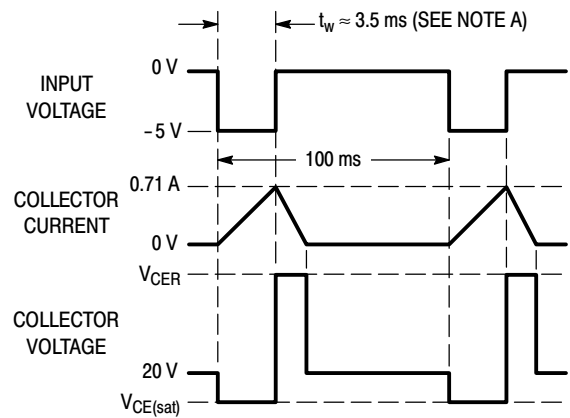
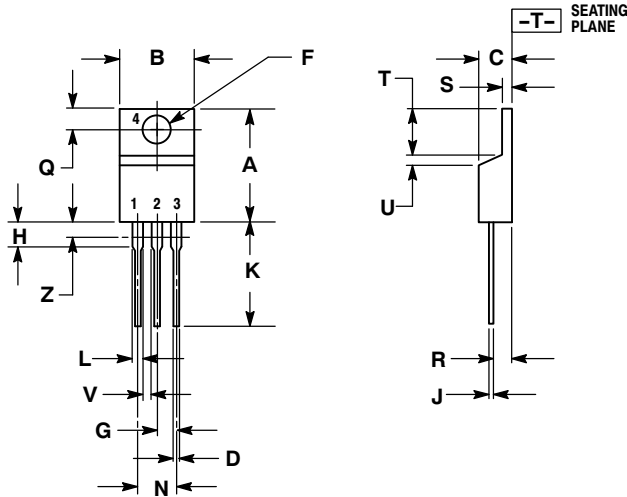

Figure 13. Inductive Load Switching

TIP110, TIP111, TIP112 (NPN); TIP115, TIP116, TIP117 (PNP)

PACKAGE DIMENSIONS

TO-220
CASE 221A-09
ISSUE AE



NOTES:

1. DIMENSIONING AND TOLERANCING PER ANSI Y14.5M, 1982.
2. CONTROLLING DIMENSION: INCH.
3. DIMENSION Z DEFINES A ZONE WHERE ALL BODY AND LEAD IRREGULARITIES ARE ALLOWED.

DIM	INCHES		MILLIMETERS	
	MIN	MAX	MIN	MAX
A	0.570	0.620	14.48	15.75
B	0.380	0.405	9.66	10.28
C	0.160	0.190	4.07	4.82
D	0.025	0.035	0.64	0.88
F	0.142	0.161	3.61	4.09
G	0.095	0.105	2.42	2.66
H	0.110	0.155	2.80	3.93
J	0.014	0.025	0.36	0.64
K	0.500	0.562	12.70	14.27
L	0.045	0.060	1.15	1.52
N	0.190	0.210	4.83	5.33
Q	0.100	0.120	2.54	3.04
R	0.080	0.110	2.04	2.79
S	0.045	0.055	1.15	1.39
T	0.235	0.255	5.97	6.47
U	0.000	0.050	0.00	1.27
V	0.045	---	1.15	---
Z	---	0.080	---	2.04

ON Semiconductor and are registered trademarks of Semiconductor Components Industries, LLC (SCILLC). SCILLC reserves the right to make changes without further notice to any products herein. SCILLC makes no warranty, representation or guarantee regarding the suitability of its products for any particular purpose, nor does SCILLC assume any liability arising out of the application or use of any product or circuit, and specifically disclaims any and all liability, including without limitation special, consequential or incidental damages. "Typical" parameters which may be provided in SCILLC data sheets and/or specifications can and do vary in different applications and actual performance may vary over time. All operating parameters, including "Typicals" must be validated for each customer application by customer's technical experts. SCILLC does not convey any license under its patent rights nor the rights of others. SCILLC products are not designed, intended, or authorized for use as components in systems intended for surgical implant into the body, or other applications intended to support or sustain life, or for any other application in which the failure of the SCILLC product could create a situation where personal injury or death may occur. Should Buyer purchase or use SCILLC products for any such unintended or unauthorized application, Buyer shall indemnify and hold SCILLC and its officers, employees, subsidiaries, affiliates, and distributors harmless against all claims, costs, damages, and expenses, and reasonable attorney fees arising out of, directly or indirectly, any claim of personal injury or death associated with such unintended or unauthorized use, even if such claim alleges that SCILLC was negligent regarding the design or manufacture of the part. SCILLC is an Equal Opportunity/Affirmative Action Employer. This literature is subject to all applicable copyright laws and is not for resale in any manner.

PUBLICATION ORDERING INFORMATION

LITERATURE FULFILLMENT:
Literature Distribution Center for ON Semiconductor
P.O. Box 5163, Denver, Colorado 80217 USA
Phone: 303-675-2175 or 800-344-3860 Toll Free USA/Canada
Fax: 303-675-2176 or 800-344-3867 Toll Free USA/Canada
Email: orderlit@onsemi.com

N. American Technical Support: 800-282-9855 Toll Free
USA/Canada
Europe, Middle East and Africa Technical Support:
Phone: 421 33 790 2910
Japan Customer Focus Center
Phone: 81-3-5773-3850

ON Semiconductor Website: www.onsemi.com
Order Literature: <http://www.onsemi.com/orderlit>

For additional information, please contact your local Sales Representative