

Surface Mounting DPDT Relay

- Long terminals ideal for soldering and mounting reliability.
- Space-saving inside-L terminal.
- High dielectric strength between coil and contacts (2,000 VAC), and between contacts of different polarity (1,500 VAC).
- High impulse withstand voltages between coil and contacts, and between contacts of different polarity (2,500 V, 2 × 10 μs: Bellcore requirements).
- Low power consumption (140 mW).
- Bifurcated crossbar contact (Au-clad) and fully sealed construction for high reliability.
- Applicable to IRS.
- High sealability after IRS.
- Ultra-miniature at 15 × 7.5 × 9.4 mm (L × W × H).
- Through-hole terminal is available.
- EN60950/EN41003 Supplementary Insulation-certified type is available.

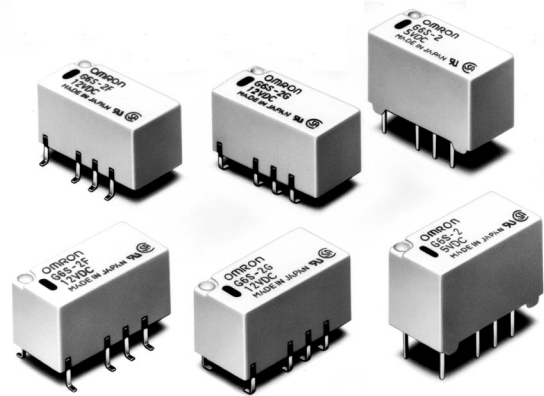

Ordering Information

Classification			Single-side stable	Single-winding latching	Double-winding latching	Single-side stable EN60950/EN41003	
DPDT	Fully sealed	Through-hole terminal	G6S-2	G6SU-2	G6SK-2	G6S-2-Y	
		Surface mounting terminal	Inside-L	G6S-2G	G6SU-2G	G6SK-2G	G6S-2G-Y
			Outside-L	G6S-2F	G6SU-2F	G6SK-2F	G6S-2F-Y

Note: 1. When ordering, add the rated coil voltage to the model number.

Example: G6S-2F 12 VDC

Rated coil voltage

2. When ordering tape packing, add "-TR" to the model number.

Example: G6S-2F-TR 12 VDC

Tape packing

Note that since "-TR" is not part of the relay model number, it is not marked on the relay case.

Model Number Legend:

G6S□-□□□-□□ VDC

1 2 3 4 5

1. Relay Function

None: Single-side stable

U: Single-winding latching

K: Double-winding latching

2. Contact Form

2: DPDT

3. Terminal Shape

None: Through-hole terminal

G: Inside-L surface mounting terminal

F: Outside-L surface mounting terminal

4. Approved Standards

None: UL/CSA

Y: EN60950/EN41003

5. Rated Coil Voltage

4.5, 5, 12, 24 VDC

Specifications

■ Coil Ratings

Single-side Stable Type (G6S-2, G6S-2F, G6S-2G)

Rated voltage	3 VDC	4.5 VDC	5 VDC	12 VDC	24 VDC
Rated current	46.7 mA	31.0 mA	28.1 mA	11.7 mA	8.3 mA
Coil resistance	64.3 Ω	145 Ω	178 Ω	1,028 Ω	2,880 Ω
Must operate voltage	75% max. of rated voltage				
Must release voltage	10% min. of rated voltage				
Max. voltage	200% of rated voltage at 23°C, 130% at 85°C				170% of rated voltage at 23°C, 130% at 85°C
Power consumption	Approx. 140 mW				Approx. 200 mW

- Note:** 1. The rated current and coil resistance are measured at a coil temperature of 23°C with a tolerance of ±10%.
2. Operating characteristics are measured at a coil temperature of 23°C.

Single-winding Latching Type (G6SU-2, G6SU-2F, G6SU-2G)

Rated voltage	3 VDC	4.5 VDC	5 VDC	12 VDC	24 VDC	
Rated current	33.3 mA	22.2 mA	20 mA	8.3 mA	6.3 mA	
Coil resistance	90 Ω	203 Ω	250 Ω	1,440 Ω	3,840 Ω	
Coil inductance (H) (ref. value)	Armature OFF	0.08	0.27	0.36	2.12	5.80
	Armature ON	0.04	0.14	0.18	1.14	3.79
Must set voltage	75% max. of rated voltage					
Must reset voltage	75% max. of rated voltage					
Max. voltage	180% of rated voltage at 23°C, 140% at 85°C					
Power consumption	Approx. 100 mW				Approx. 150 mW	

- Note:** 1. The rated current and coil resistance are measured at a coil temperature of 23°C with a tolerance of ±10%.
2. Operating characteristics are measured at a coil temperature of 23°C.

Double-winding Latching Type (G6SK-2, G6SK-2F, G6SK-2G)

Rated voltage	3 VDC	4.5 VDC	5 VDC	12 VDC	24 VDC		
Rated current	66.6 mA	44.4 mA	40 mA	16.7 mA	12.5 mA		
Coil resistance	45 Ω	101 Ω	125 Ω	720 Ω	1,920 Ω		
Coil inductance (H) (ref. value)	Set	Armature OFF	0.05	0.12	0.14	0.60	1.98
		Armature ON	0.03	0.074	0.088	0.41	1.23
	Reset	Armature OFF	0.03	0.082	0.098	0.46	1.34
		Armature ON	0.06	0.14	0.16	0.54	2.23
Must set voltage	75% max. of rated voltage						
Must reset voltage	75% max. of rated voltage						
Max. voltage	170% of rated voltage at 23°C, 130% at 85°C				140% of rated voltage at 23°C, 110% at 70°C		
Power consumption	Approx. 200 mW				Approx. 300 mW		

- Note:** 1. The rated current and coil resistance are measured at a coil temperature of 23°C with a tolerance of ±10%.
2. Operating characteristics are measured at a coil temperature of 23°C.

Single-side Stable EN60950/EN41003 Approved Type (G6S-2-Y, G6S-2F-Y, G6S-2G-Y)

Rated voltage	5 VDC	12 VDC	24 VDC
Rated current	40 mA	16.7 mA	9.6 mA
Coil resistance	125 Ω	720 Ω	2,504 Ω
Must operate voltage	75% max. of rated voltage		
Must release voltage	10% min. of rated voltage		
Max. voltage	170% of rated voltage at 23°C, 130% at 85°C		170% of rated voltage at 23°C, 110% at 70°C
Power consumption	Approx. 200 mW		Approx. 230 mW

- Note:** 1. The rated current and coil resistance are measured at a coil temperature of 23°C with a tolerance of ±10%.
2. Operating characteristics are measured at a coil temperature of 23°C.

■ Contact Ratings

Load	Resistive load ($\cos\phi = 1$)
Rated load	0.5 A at 125 VAC; 2 A at 30 VDC
Contact material	Ag (Au-clad)
Rated carry current	2 A
Max. switching voltage	250 VAC, 220 VDC
Max. switching current	2 A
Max. switching capacity	62.5 VA, 60 W
Failure rate (reference value)	10 μ A at 10 mVDC

Note: P level: $\lambda_{60} = 0.1 \times 10^{-6}/\text{operation}$

■ Characteristics

Contact resistance	75 m Ω max.
Operate (set) time	4 ms max. (mean value: approx. 2.5 ms; latching type: approx. 2 ms)
Release (reset) time	4 ms max. (mean value: approx. 1.5 ms; latching type: approx. 2 ms)
Bounce time	Operate: Approx. 0.5 ms Release: Approx. 0.5 ms Set/Reset: Approx. 0.5 ms
Max. operating frequency	Mechanical: 36,000 operations/hr Electrical: 1,800 operations/hr (under rated load)
Insulation resistance	1,000 M Ω min. (at 500 VDC)
Dielectric strength	2,000 VAC, 50/60 Hz for 1 min between coil and contacts 1,000 VAC, 50/60 Hz for 1 min between coil and contacts (double-winding latching) 1,500 VAC, 50/60 Hz for 1 min between contacts of different polarity 1,000 VAC, 50/60 Hz for 1 min between contacts of same polarity 500 VAC, 50/60 Hz for 1 min between set and reset coil (double-winding latching)
Impulse withstand voltage	2,500 V (2 x 10 μ s) between coil and contacts 1,500 V (10 x 160 μ s) between coil and contacts (double-winding latching) 2,500 V (2 x 10 μ s) between contacts of different polarity 1,500 V (10 x 160 μ s) between contacts of same polarity (conforms to FCC Part 68)
Vibration resistance	Destruction: 10 to 55 to 10 Hz, 2.5-mm single amplitude (5-mm double amplitude) Malfunction: 10 to 55 to 10 Hz, 1.65-mm single amplitude (3.3-mm double amplitude)
Shock resistance	Destruction: 1,000 m/s ² (approx. 100G) Malfunction: 750 m/s ² (approx. 75G)
Endurance	Mechanical: 100,000,000 operations min. (at 36,000 operations/hr) Electrical: 100,000 operations min. (2 A at 30 VDC, resistive load: 1,200 operations/hr) 100,000 operations min. (0.5 A at 125 VAC, resistive load)
Ambient temperature	Operating: -40°C to 85°C (with no icing), -40°C to 70°C (double-winding latching, 24 VDC)
Ambient humidity	Operating: 5% to 85%
Weight	Approx. 2 g

■ Approved Standards

UL1950 (File No. E41515)/CSA C22.2 No.950 (File No. LR24825)

Model	Contact form	Coil ratings	Contact ratings
G6S-2, G6S-2F, G6S-2G	DPDT	1.5 to 48 VDC	2 A, 30 VDC
G6SU-2, G6SK-2, G6SU-2F, G6SU-2G, G6SK-2F, G6SK-2G		1.5 to 24 VDC	0.3 A, 110 VDC 0.5 A, 125 VAC

EN60950/EN41003

Model	Contact form	Isolation category	Voltage
G6S-2-Y, G6S-2G-Y, G6S-2F-Y	DPDT	Supplementary Isolation	250 VAC

Engineering Data

Max. Switching Capacity

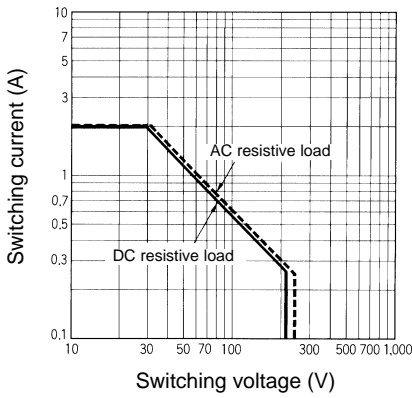

Ambient Temperature vs. Maximum Voltage Single-side Stable

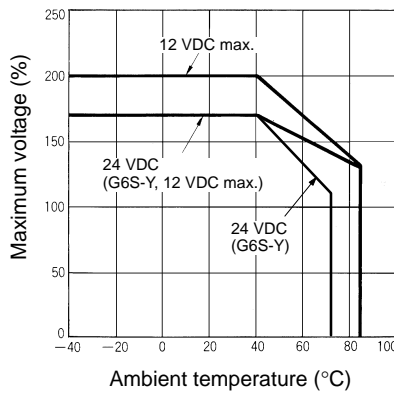

Single-winding Latching Double-winding Latching

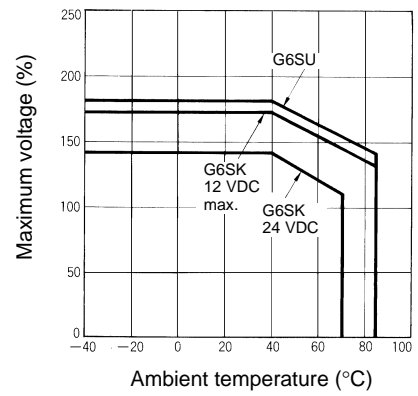

Reference Data

Ambient Temperature vs. Switching Current

Single-side Stable

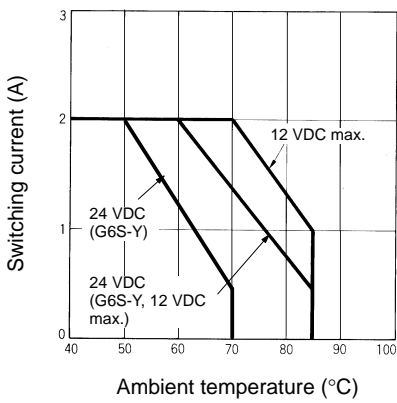

Single-winding Latching Double-winding Latching

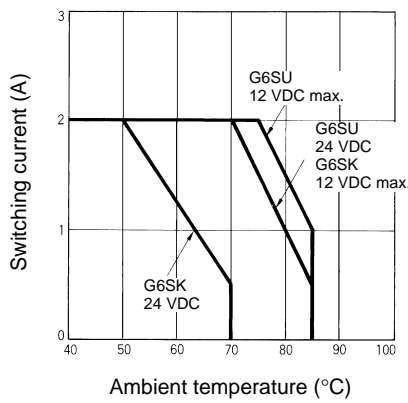

Endurance

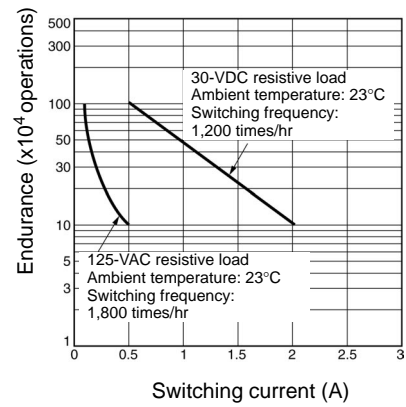

Recommended Soldering Time vs. Surface PCB Temperature

(The temperature profile indicates the temperature on the surface of the PCB.)

IRS

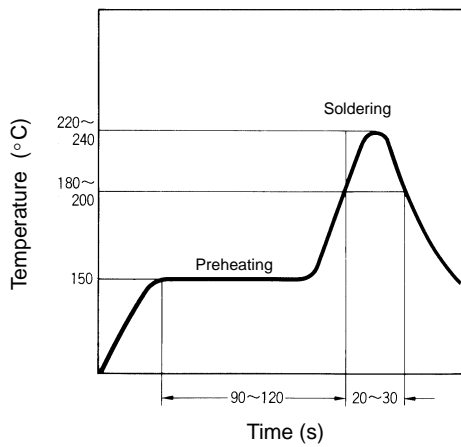

Dimensions

Note: All units are in millimeters unless otherwise indicated.

Single-side Stable

G6S-2, G6S-2-Y

Tolerance: ± 0.3

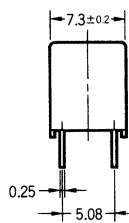
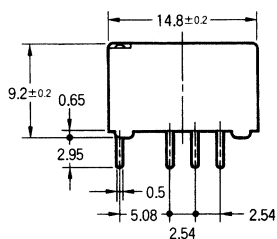
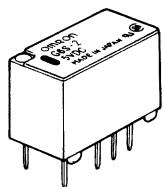

Footprint (Bottom View)

Tolerance: ± 0.1

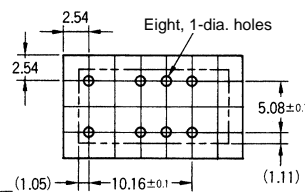

Terminal Arrangement/ Internal Connections (Bottom View)

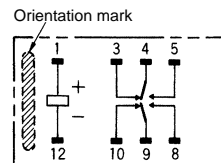

G6S-2F, G6S-2F-Y

Tolerance: ± 0.3

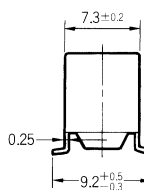
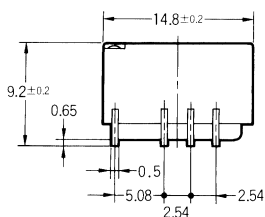
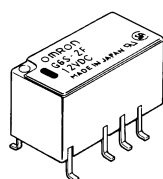

Footprint (Top View)

Tolerance: ± 0.1

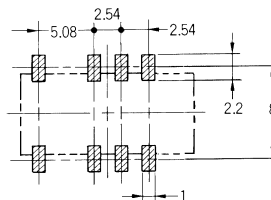

Terminal Arrangement/ Internal Connections (Top View)

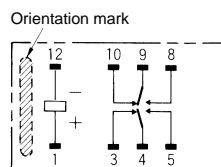

G6S-2G, G6S-2G-Y

Tolerance: ± 0.3

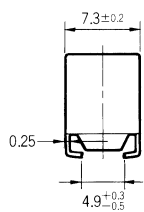
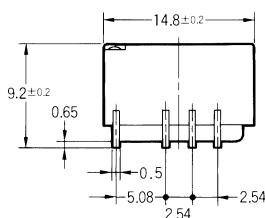
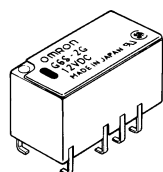

Footprint (Top View)

Tolerance: ± 0.1

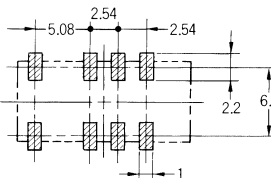

Terminal Arrangement/ Internal Connections (Top View)

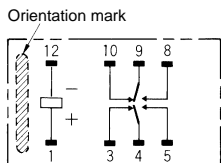

Single-winding Latching

G6SU-2

Tolerance: ± 0.3

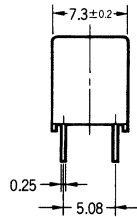
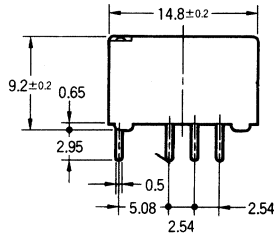
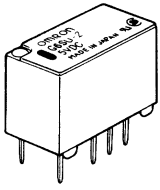

Footprint (Bottom View)

Tolerance: ± 0.1

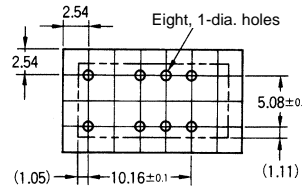

Terminal Arrangement/ Internal Connections (Bottom View)

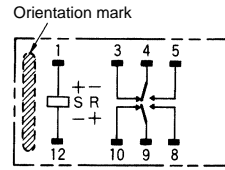

G6SU-2F

Tolerance: ± 0.3

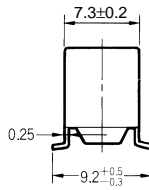
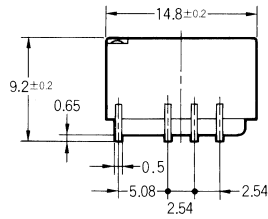
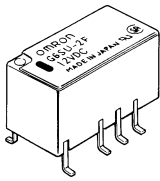

Footprint (Top View)

Tolerance: ± 0.1

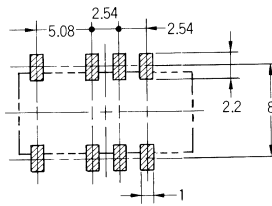

Terminal Arrangement/ Internal Connections (Top View)

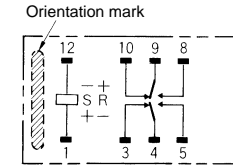

G6SU-2G

Tolerance: ± 0.3

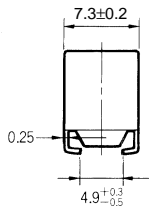
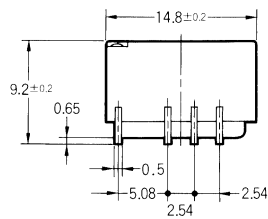
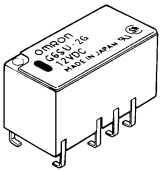

Footprint (Top View)

Tolerance: ± 0.1

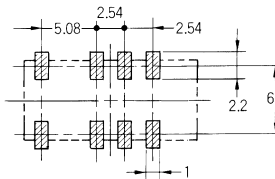

Terminal Arrangement/ Internal Connections (Top View)

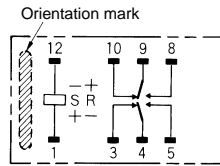

Double-winding Latching

G6SK-2

Tolerance: ± 0.3

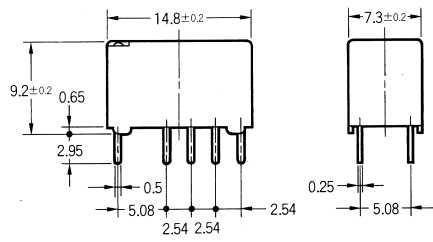
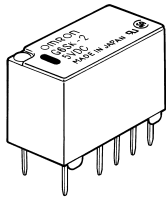

Footprint (Bottom View)

Tolerance: ± 0.1

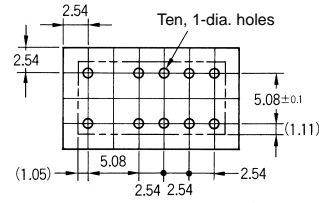

Terminal Arrangement/ Internal Connections (Bottom View)

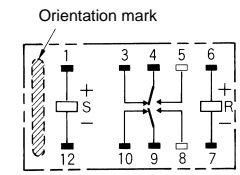

G6SK-2F

Tolerance: ± 0.3

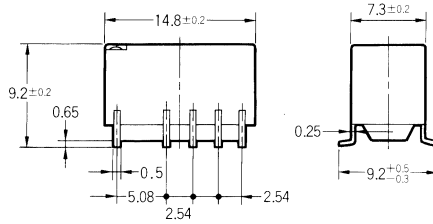
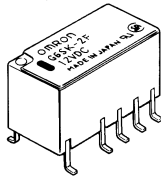

Footprint (Top View)

Tolerance: ± 0.1

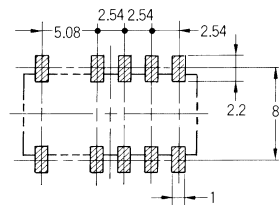

Terminal Arrangement/ Internal Connections (Top View)

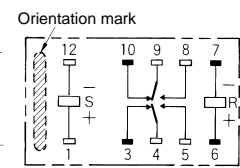

G6SK-2G

Tolerance: ± 0.3

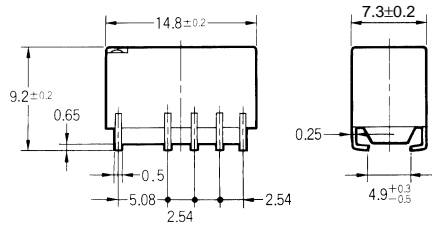
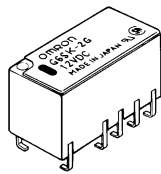

Footprint (Top View)

Tolerance: ± 0.1

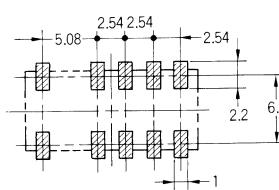

Terminal Arrangement/ Internal Connections (Top View)

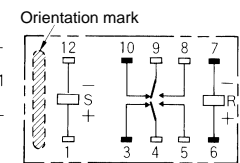

■ Tape Packing

When ordering, add "-TR" before the rated coil voltage for tape packing.

Tape type: TE2416R (Refer to EIAJ)

Reel type: R24E (Refer to EIAJ)

Relays per reel: 400

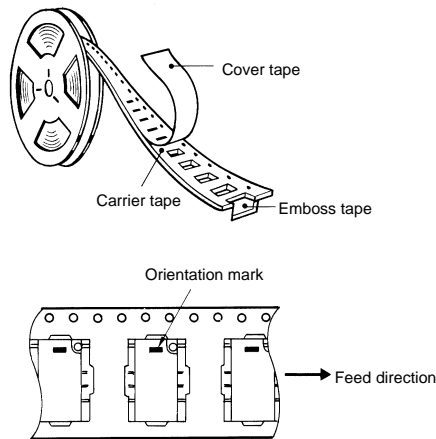
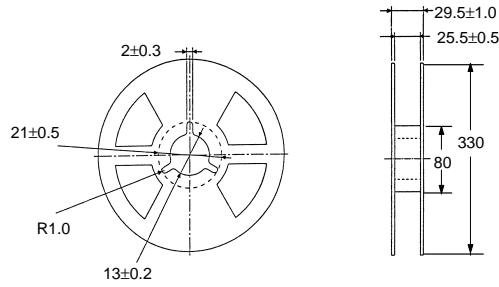

G6S-2F, G6SU-2F, G6SK-2F, G6S-2F-Y

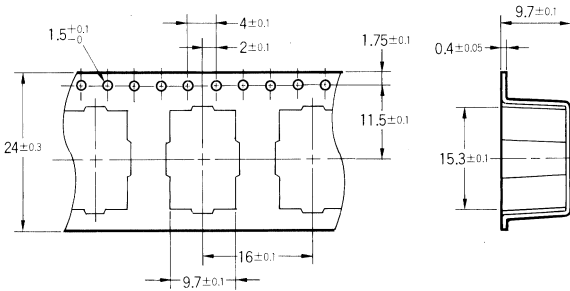

G6S-2G, G6SU-2G, G6SK-2G, G6S-2G-Y

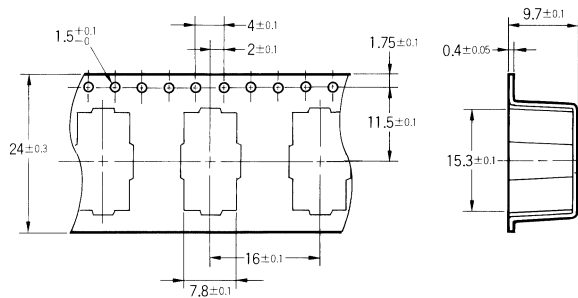

Precautions

Use a DC power supply with 5% or less ripple factor to operate the coil.

Do not use the G6S where subject to strong external magnetic fields.

Do not use the G6S where subject to magnetic particles or excessive amounts of dust.

Do not reverse the polarity of the coil (+, -).

Latching types are delivered in the reset position. We recommend that a reset voltage be applied in advance to start operation.

Do not drop the G6S or otherwise subject it to excessive shock.

Remove the relay from the packing immediately prior to usage.

ALL DIMENSIONS SHOWN ARE IN MILLIMETERS.

To convert millimeters into inches, multiply by 0.03937. To convert grams into ounces, multiply by 0.03527.

Cat. No. K093-E1-04 In the interest of product improvement, specifications are subject to change without notice.

OMRON Corporation

Electronics Components Company

Electronic & Mechanical Components Division H.Q.

Low Signal Relay Division

2-1, 2-Chome, Nishikusatsu, Kusatsu-City,
Shiga, 525-0035 Japan

Tel: (81)77-565-5481/Fax: (81)77-565-5581

Printed in Japan
0702-1M (0595) (A)