

MC7800, MC7800A, NCV7805



ON Semiconductor®

<http://onsemi.com>

1.0 A Positive Voltage Regulators

These voltage regulators are monolithic integrated circuits designed as fixed-voltage regulators for a wide variety of applications including local, on-card regulation. These regulators employ internal current limiting, thermal shutdown, and safe-area compensation. With adequate heatsinking they can deliver output currents in excess of 1.0 A. Although designed primarily as a fixed voltage regulator, these devices can be used with external components to obtain adjustable voltages and currents.

- Output Current in Excess of 1.0 A
- No External Components Required
- Internal Thermal Overload Protection
- Internal Short Circuit Current Limiting
- Output Transistor Safe-Area Compensation
- Output Voltage Offered in 2% and 4% Tolerance
- Available in Surface Mount D²PAK-3, DPAK-3 and Standard 3-Lead Transistor Packages
- NCV Prefix for Automotive and Other Applications Requiring Site and Control Changes
- Pb-Free Packages are Available

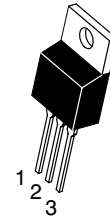

**TO-220-3
T SUFFIX
CASE 221AB**

Heatsink surface
connected to Pin 2.

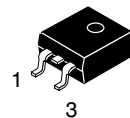

**D²PAK-3
D2T SUFFIX
CASE 936**

Pin 1. Input
2. Ground
3. Output
Heatsink surface (shown as terminal 4 in case outline drawing) is connected to Pin 2.

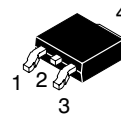

**DPAK-3
DT SUFFIX
CASE 369C**

MAXIMUM RATINGS (T_A = 25°C, unless otherwise noted)

Rating	Symbol	Value			Unit
		369C	221A	936	
Input Voltage (5.0 - 18 V) (24 V)	V _I	35 40			Vdc
Power Dissipation	P _D	Internally Limited			W
Thermal Resistance, Junction-to-Ambient	R _{θJA}	92	65	Figure 14	°C/W
Thermal Resistance, Junction-to-Case	R _{θJC}	5.0	5.0	5.0	°C/W
Storage Junction Temperature Range	T _{stg}	-65 to +150			°C
Operating Junction Temperature	T _J	+150			°C

Stresses exceeding Maximum Ratings may damage the device. Maximum Ratings are stress ratings only. Functional operation above the Recommended Operating Conditions is not implied. Extended exposure to stresses above the Recommended Operating Conditions may affect device reliability.

*This device series contains ESD protection and exceeds the following tests:
Human Body Model 2000 V per MIL_STD_883, Method 3015.
Machine Model Method 200 V.

STANDARD APPLICATION

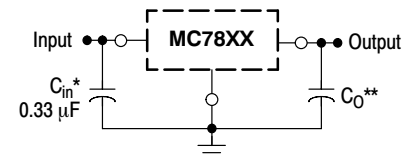

A common ground is required between the input and the output voltages. The input voltage must remain typically 2.0 V above the output voltage even during the low point on the input ripple voltage.

XX, These two digits of the type number indicate nominal voltage.

* C_{in} is required if regulator is located an appreciable distance from power supply filter.

** C_O is not needed for stability; however, it does improve transient response. Values of less than 0.1 μF could cause instability.

ORDERING INFORMATION

See detailed ordering and shipping information in the package dimensions section on page 22 of this data sheet.

DEVICE MARKING INFORMATION

See general marking information in the device marking section on page 29 of this data sheet.

MC7800, MC7800A, NCV7805

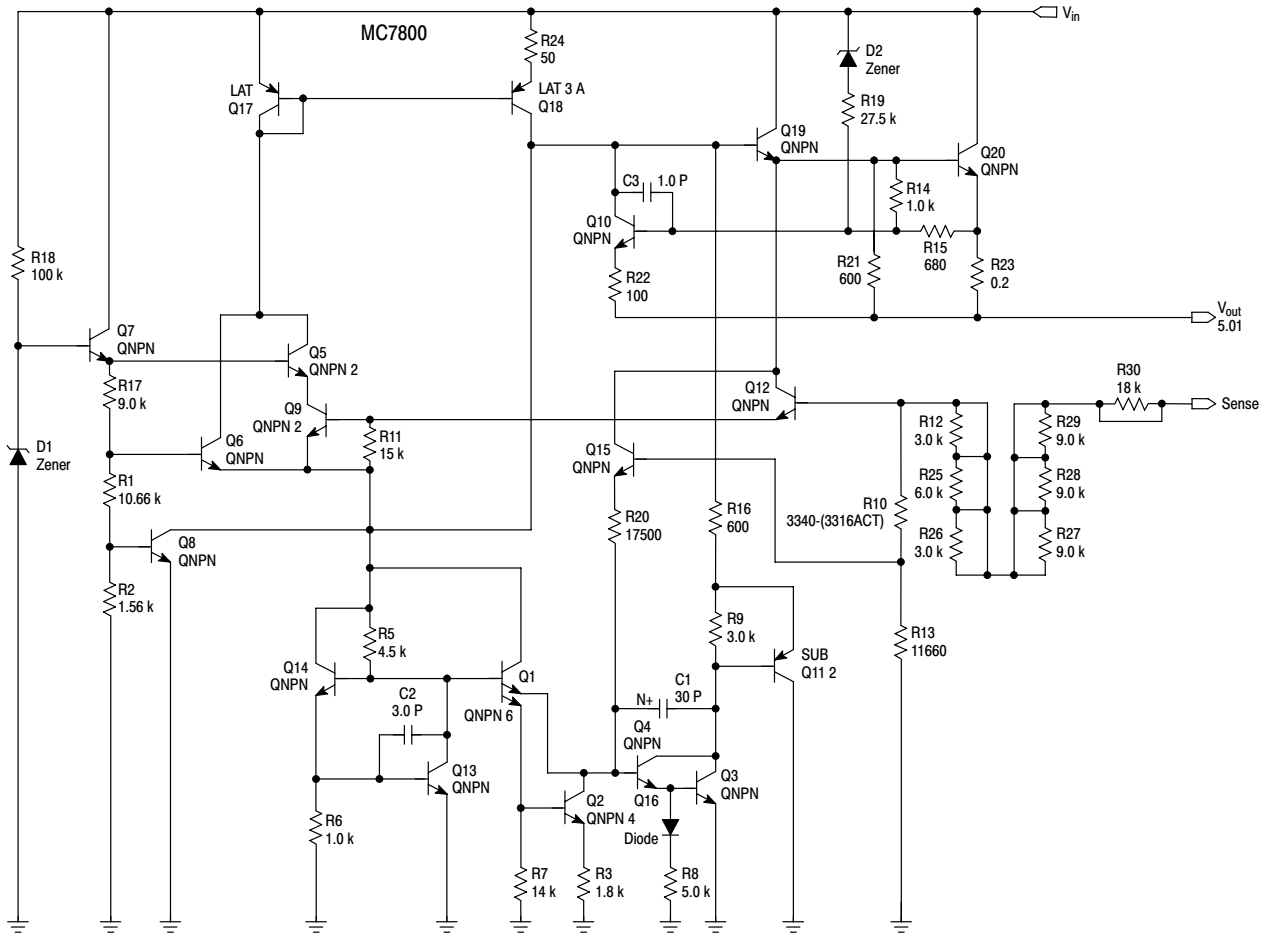

This device contains 22 active transistors.

Figure 1. Representative Schematic Diagram

MC7800, MC7800A, NCV7805

ELECTRICAL CHARACTERISTICS ($V_{in} = 10\text{ V}$, $I_O = 500\text{ mA}$, $T_J = T_{low}$ to T_{high} (Note 1), unless otherwise noted)

Characteristic	Symbol	MC7805B, NCV7805			MC7805C			Unit
		Min	Typ	Max	Min	Typ	Max	
Output Voltage ($T_J = 25^\circ\text{C}$)	V_O	4.8	5.0	5.2	4.8	5.0	5.2	Vdc
Output Voltage ($5.0\text{ mA} \leq I_O \leq 1.0\text{ A}$, $P_D \leq 15\text{ W}$) $7.0\text{ Vdc} \leq V_{in} \leq 20\text{ Vdc}$ $8.0\text{ Vdc} \leq V_{in} \leq 20\text{ Vdc}$	V_O	- 4.75	- 5.0	- 5.25	4.75 -	5.0 -	5.25 -	Vdc
Line Regulation (Note 4) $7.5\text{ Vdc} \leq V_{in} \leq 20\text{ Vdc}$, 1.0 A $8.0\text{ Vdc} \leq V_{in} \leq 12\text{ Vdc}$	Reg_{line}	- -	5.0 1.3	100 50	- -	0.5 0.8	20 10	mV
Load Regulation (Note 4) $5.0\text{ mA} \leq I_O \leq 1.0\text{ A}$ $5.0\text{ mA} \leq I_O \leq 1.5\text{ A}$ ($T_A = 25^\circ\text{C}$)	Reg_{load}	- -	1.3 0.15	100 50	- -	1.3 1.3	25 25	mV
Quiescent Current	I_B	-	3.2	8.0	-	3.2	6.5	mA
Quiescent Current Change $7.0\text{ Vdc} \leq V_{in} \leq 25\text{ Vdc}$ $5.0\text{ mA} \leq I_O \leq 1.0\text{ A}$ ($T_A = 25^\circ\text{C}$)	ΔI_B	- -	- -	- 0.5	- -	0.3 0.08	1.0 0.8	mA
Ripple Rejection $8.0\text{ Vdc} \leq V_{in} \leq 18\text{ Vdc}$, $f = 120\text{ Hz}$	RR	-	68	-	62	83	-	dB
Dropout Voltage ($I_O = 1.0\text{ A}$, $T_J = 25^\circ\text{C}$)	$V_I - V_O$	-	2.0	-	-	2.0	-	Vdc
Output Noise Voltage ($T_A = 25^\circ\text{C}$) $10\text{ Hz} \leq f \leq 100\text{ kHz}$	V_n	-	10	-	-	10	-	$\mu\text{V}/V_O$
Output Resistance $f = 1.0\text{ kHz}$	r_O	-	0.9	-	-	0.9	-	$\text{m}\Omega$
Short Circuit Current Limit ($T_A = 25^\circ\text{C}$) $V_{in} = 35\text{ Vdc}$	I_{SC}	-	0.2	-	-	0.6	-	A
Peak Output Current ($T_J = 25^\circ\text{C}$)	I_{max}	-	2.2	-	-	2.2	-	A
Average Temperature Coefficient of Output Voltage	TCV_O	-	-0.3	-	-	-0.3	-	$\text{mV}/^\circ\text{C}$

1. $T_{low} = 0^\circ\text{C}$ for MC78XXAC, C, $T_{high} = +125^\circ\text{C}$ for MC78XXAC, NCV7805
= -40°C for MC78XXB, MC78XXAB, NCV7805

2. Load and line regulation are specified at constant junction temperature. Changes in V_O due to heating effects must be taken into account separately. Pulse testing with low duty cycle is used.

MC7800, MC7800A, NCV7805

ELECTRICAL CHARACTERISTICS ($V_{in} = 10\text{ V}$, $I_O = 1.0\text{ A}$, $T_J = T_{low}$ to T_{high} (Note 3), unless otherwise noted)

Characteristic	Symbol	MC7805AB/MC7805AC			Unit
		Min	Typ	Max	
Output Voltage ($T_J = 25^\circ\text{C}$)	V_O	4.9	5.0	5.1	Vdc
Output Voltage ($5.0\text{ mA} \leq I_O \leq 1.0\text{ A}$, $P_D \leq 15\text{ W}$) $7.5\text{ Vdc} \leq V_{in} \leq 20\text{ Vdc}$	V_O	4.8	5.0	5.2	Vdc
Line Regulation (Note 4) $7.5\text{ Vdc} \leq V_{in} \leq 25\text{ Vdc}$, $I_O = 500\text{ mA}$ $8.0\text{ Vdc} \leq V_{in} \leq 12\text{ Vdc}$, $I_O = 1.0\text{ A}$ $8.0\text{ Vdc} \leq V_{in} \leq 12\text{ Vdc}$, $I_O = 1.0\text{ A}$, $T_J = 25^\circ\text{C}$ $7.3\text{ Vdc} \leq V_{in} \leq 20\text{ Vdc}$, $I_O = 1.0\text{ A}$, $T_J = 25^\circ\text{C}$	Reg_{line}	-	0.5	10	mV
Load Regulation (Note 4) $5.0\text{ mA} \leq I_O \leq 1.5\text{ A}$, $T_J = 25^\circ\text{C}$ $5.0\text{ mA} \leq I_O \leq 1.0\text{ A}$ $250\text{ mA} \leq I_O \leq 750\text{ mA}$	Reg_{load}	-	1.3	25	mV
Quiescent Current	I_B	-	3.2	6.0	mA
Quiescent Current Change $8.0\text{ Vdc} \leq V_{in} \leq 25\text{ Vdc}$, $I_O = 500\text{ mA}$ $7.5\text{ Vdc} \leq V_{in} \leq 20\text{ Vdc}$, $T_J = 25^\circ\text{C}$ $5.0\text{ mA} \leq I_O \leq 1.0\text{ A}$	ΔI_B	-	0.3	0.8	mA
Ripple Rejection $8.0\text{ Vdc} \leq V_{in} \leq 18\text{ Vdc}$, $f = 120\text{ Hz}$, $I_O = 500\text{ mA}$	RR	68	83	-	dB
Dropout Voltage ($I_O = 1.0\text{ A}$, $T_J = 25^\circ\text{C}$)	$V_I - V_O$	-	2.0	-	Vdc
Output Noise Voltage ($T_A = 25^\circ\text{C}$) $10\text{ Hz} \leq f \leq 100\text{ kHz}$	V_n	-	10	-	$\mu\text{V}/V_O$
Output Resistance ($f = 1.0\text{ kHz}$)	r_O	-	0.9	-	$\text{m}\Omega$
Short Circuit Current Limit ($T_A = 25^\circ\text{C}$) $V_{in} = 35\text{ Vdc}$	I_{SC}	-	0.2	-	A
Peak Output Current ($T_J = 25^\circ\text{C}$)	I_{max}	-	2.2	-	A
Average Temperature Coefficient of Output Voltage	TCV_O	-	-0.3	-	$\text{mV}/^\circ\text{C}$

3. $T_{low} = 0^\circ\text{C}$ for MC78XXAC, C $T_{high} = +125^\circ\text{C}$ for MC78XXAC, C, NCV7805
= -40°C for MC78XXB, MC78XXAB, NCV7805

4. Load and line regulation are specified at constant junction temperature. Changes in V_O due to heating effects must be taken into account separately. Pulse testing with low duty cycle is used.

MC7800, MC7800A, NCV7805

ELECTRICAL CHARACTERISTICS ($V_{in} = 11\text{ V}$, $I_O = 500\text{ mA}$, $T_J = T_{low}$ to T_{high} (Note 5), unless otherwise noted)

Characteristic	Symbol	MC7806B			MC7806C			Unit
		Min	Typ	Max	Min	Typ	Max	
Output Voltage ($T_J = 25^\circ\text{C}$)	V_O	5.75	6.0	6.25	5.75	6.0	6.25	Vdc
Output Voltage ($5.0\text{ mA} \leq I_O \leq 1.0\text{ A}$, $P_D \leq 15\text{ W}$)	V_O							Vdc
$8.0\text{ Vdc} \leq V_{in} \leq 21\text{ Vdc}$		-	-	-	5.7	6.0	6.3	
$9.0\text{ Vdc} \leq V_{in} \leq 21\text{ Vdc}$		5.7	6.0	6.3	-	-	-	
Line Regulation, $T_J = 25^\circ\text{C}$ (Note 6)	Reg_{line}							mV
$8.0\text{ Vdc} \leq V_{in} \leq 25\text{ Vdc}$		-	5.5	120	-	0.5	24	
$9.0\text{ Vdc} \leq V_{in} \leq 13\text{ Vdc}$		-	1.4	60	-	0.8	12	
Load Regulation, $T_J = 25^\circ\text{C}$ (Note 6)	Reg_{load}	-	1.3	120	-	1.3	30	mV
$5.0\text{ mA} \leq I_O \leq 1.5\text{ A}$								
Quiescent Current ($T_J = 25^\circ\text{C}$)	I_B	-	3.3	8.0	-	3.3	8.0	mA
Quiescent Current Change	ΔI_B							mA
$8.0\text{ Vdc} \leq V_{in} \leq 25\text{ Vdc}$		-	-	-	-	0.3	1.3	
$5.0\text{ mA} \leq I_O \leq 1.0\text{ A}$		-	-	0.5	-	0.08	0.5	
Ripple Rejection	RR	-	65	-	58	65	-	dB
$9.0\text{ Vdc} \leq V_{in} \leq 19\text{ Vdc}$, $f = 120\text{ Hz}$								
Dropout Voltage ($I_O = 1.0\text{ A}$, $T_J = 25^\circ\text{C}$)	$V_I - V_O$	-	2.0	-	-	2.0	-	Vdc
Output Noise Voltage ($T_A = 25^\circ\text{C}$)	V_n	-	10	-	-	10	-	$\mu\text{V}/V_O$
$10\text{ Hz} \leq f \leq 100\text{ kHz}$								
Output Resistance $f = 1.0\text{ kHz}$	r_O	-	0.9	-	-	0.9	-	$\text{m}\Omega$
Short Circuit Current Limit ($T_A = 25^\circ\text{C}$)	I_{SC}	-	0.2	-	-	0.2	-	A
$V_{in} = 35\text{ Vdc}$								
Peak Output Current ($T_J = 25^\circ\text{C}$)	I_{max}	-	2.2	-	-	2.2	-	A
Average Temperature Coefficient of Output Voltage	TCV_O	-	-0.3	-	-	-0.3	-	$\text{mV}/^\circ\text{C}$

5. $T_{low} = 0^\circ\text{C}$ for MC78XXAC, C $T_{high} = +125^\circ\text{C}$ for MC78XXAC, NCV7805
 = -40°C for MC78XXB, MC78XXAB, NCV7805

6. Load and line regulation are specified at constant junction temperature. Changes in V_O due to heating effects must be taken into account separately. Pulse testing with low duty cycle is used.

MC7800, MC7800A, NCV7805

ELECTRICAL CHARACTERISTICS ($V_{in} = 11\text{ V}$, $I_O = 1.0\text{ A}$, $T_J = T_{low}$ to T_{high} (Note 7), unless otherwise noted)

Characteristic	Symbol	MC7806AC			Unit
		Min	Typ	Max	
Output Voltage ($T_J = 25^\circ\text{C}$)	V_O	5.88	6.0	6.12	Vdc
Output Voltage ($5.0\text{ mA} \leq I_O \leq 1.0\text{ A}$, $P_D \leq 15\text{ W}$) $8.6\text{ Vdc} \leq V_{in} \leq 21\text{ Vdc}$	V_O	5.76	6.0	6.24	Vdc
Line Regulation (Note 8) $8.6\text{ Vdc} \leq V_{in} \leq 25\text{ Vdc}$, $I_O = 500\text{ mA}$ $9.0\text{ Vdc} \leq V_{in} \leq 13\text{ Vdc}$, $I_O = 1.0\text{ A}$	Reg_{line}	-	5.0	12	mV
Load Regulation (Note 8) $5.0\text{ mA} \leq I_O \leq 1.5\text{ A}$, $T_J = 25^\circ\text{C}$ $5.0\text{ mA} \leq I_O \leq 1.0\text{ A}$ $250\text{ mA} \leq I_O \leq 750\text{ mA}$	Reg_{load}	-	1.3	25	mV
Quiescent Current	I_B	-	3.3	6.0	mA
Quiescent Current Change $9.0\text{ Vdc} \leq V_{in} \leq 25\text{ Vdc}$, $I_O = 500\text{ mA}$ $9.0\text{ Vdc} \leq V_{in} \leq 21\text{ Vdc}$, $I_O = 1.0\text{ A}$, $T_J = 25^\circ\text{C}$ $5.0\text{ mA} \leq I_O \leq 1.0\text{ A}$	ΔI_B	-	-	0.8	mA
Ripple Rejection $9.0\text{ Vdc} \leq V_{in} \leq 19\text{ Vdc}$, $f = 120\text{ Hz}$, $I_O = 500\text{ mA}$	RR	58	65	-	dB
Dropout Voltage ($I_O = 1.0\text{ A}$, $T_J = 25^\circ\text{C}$)	$V_I - V_O$	-	2.0	-	Vdc
Output Noise Voltage ($T_A = 25^\circ\text{C}$) $10\text{ Hz} \leq f \leq 100\text{ kHz}$	V_n	-	10	-	$\mu\text{V}/V_O$
Output Resistance ($f = 1.0\text{ kHz}$)	r_O	-	0.9	-	$\text{m}\Omega$
Short Circuit Current Limit ($T_A = 25^\circ\text{C}$) $V_{in} = 35\text{ Vdc}$	I_{SC}	-	0.2	-	A
Peak Output Current ($T_J = 25^\circ\text{C}$)	I_{max}	-	2.2	-	A
Average Temperature Coefficient of Output Voltage	TCV_O	-	-0.3	-	$\text{mV}/^\circ\text{C}$

7. $T_{low} = 0^\circ\text{C}$ for MC78XXAC, C $T_{high} = +125^\circ\text{C}$ for MC78XXAC, C, NCV7805
 = -40°C for MC78XXB, MC78XXAB, NCV7805

8. Load and line regulation are specified at constant junction temperature. Changes in V_O due to heating effects must be taken into account separately. Pulse testing with low duty cycle is used.

MC7800, MC7800A, NCV7805

ELECTRICAL CHARACTERISTICS ($V_{in} = 14\text{ V}$, $I_O = 500\text{ mA}$, $T_J = T_{low}$ to T_{high} (Note 9), unless otherwise noted)

Characteristic	Symbol	MC7808B			MC7808C			Unit
		Min	Typ	Max	Min	Typ	Max	
Output Voltage ($T_J = 25^\circ\text{C}$)	V_O	7.7	8.0	8.3	7.7	8.0	8.3	Vdc
Output Voltage ($5.0\text{ mA} \leq I_O \leq 1.0\text{ A}$, $P_D \leq 15\text{ W}$)	V_O							Vdc
$10.5\text{ Vdc} \leq V_{in} \leq 23\text{ Vdc}$		-	-	-	7.6	8.0	8.4	
$11.5\text{ Vdc} \leq V_{in} \leq 23\text{ Vdc}$		7.6	8.0	8.4	-	-	-	
Line Regulation, $T_J = 25^\circ\text{C}$, (Note 10)	Reg_{line}							mV
$10.5\text{ Vdc} \leq V_{in} \leq 25\text{ Vdc}$		-	6.0	160	-	6.0	32	
$11\text{ Vdc} \leq V_{in} \leq 17\text{ Vdc}$		-	1.7	80	-	1.7	16	
Load Regulation, $T_J = 25^\circ\text{C}$ (Note 10)	Reg_{load}	-	1.4	160	-	1.4	35	mV
$5.0\text{ mA} \leq I_O \leq 1.5\text{ A}$								
Quiescent Current	I_B	-	3.3	8.0	-	3.3	8.0	mA
Quiescent Current Change	ΔI_B							mA
$10.5\text{ Vdc} \leq V_{in} \leq 25\text{ Vdc}$		-	-	-	-	-	1.0	
$5.0\text{ mA} \leq I_O \leq 1.0\text{ A}$		-	-	0.5	-	-	0.5	
Ripple Rejection	RR	-	62	-	56	62	-	dB
$11.5\text{ Vdc} \leq V_{in} \leq 18\text{ Vdc}$, $f = 120\text{ Hz}$								
Dropout Voltage ($I_O = 1.0\text{ A}$, $T_J = 25^\circ\text{C}$)	$V_I - V_O$	-	2.0	-	-	2.0	-	Vdc
Output Noise Voltage ($T_A = 25^\circ\text{C}$)	V_n	-	10	-	-	10	-	$\mu\text{V}/V_O$
$10\text{ Hz} \leq f \leq 100\text{ kHz}$								
Output Resistance $f = 1.0\text{ kHz}$	r_O	-	0.9	-	-	0.9	-	$\text{m}\Omega$
Short Circuit Current Limit ($T_A = 25^\circ\text{C}$)	I_{SC}	-	0.2	-	-	0.2	-	A
$V_{in} = 35\text{ Vdc}$								
Peak Output Current ($T_J = 25^\circ\text{C}$)	I_{max}	-	2.2	-	-	2.2	-	A
Average Temperature Coefficient of Output Voltage	TCV_O	-	-0.4	-	-	-0.4	-	$\text{mV}/^\circ\text{C}$

9. $T_{low} = 0^\circ\text{C}$ for MC78XXAC, C $T_{high} = +125^\circ\text{C}$ for MC78XXAC, C, NCV7805
 = -40°C for MC78XXB, MC78XXAB, NCV7805

10. Load and line regulation are specified at constant junction temperature. Changes in V_O due to heating effects must be taken into account separately. Pulse testing with low duty cycle is used.

MC7800, MC7800A, NCV7805

ELECTRICAL CHARACTERISTICS ($V_{in} = 14\text{ V}$, $I_O = 1.0\text{ A}$, $T_J = T_{low}$ to T_{high} (Note 11), unless otherwise noted)

Characteristic	Symbol	MC7808AB/MC7808AC			Unit
		Min	Typ	Max	
Output Voltage ($T_J = 25^\circ\text{C}$)	V_O	7.84	8.0	8.16	Vdc
Output Voltage ($5.0\text{ mA} \leq I_O \leq 1.0\text{ A}$, $P_D \leq 15\text{ W}$) $10.6\text{ Vdc} \leq V_{in} \leq 23\text{ Vdc}$	V_O	7.7	8.0	8.3	Vdc
Line Regulation (Note 12) $10.6\text{ Vdc} \leq V_{in} \leq 25\text{ Vdc}$, $I_O = 500\text{ mA}$ $11\text{ Vdc} \leq V_{in} \leq 17\text{ Vdc}$, $I_O = 1.0\text{ A}$ $10.4\text{ Vdc} \leq V_{in} \leq 23\text{ Vdc}$, $T_J = 25^\circ\text{C}$	Reg_{line}	-	6.0 1.7 5.0	15 18 15	mV
Load Regulation (Note 12) $5.0\text{ mA} \leq I_O \leq 1.5\text{ A}$, $T_J = 25^\circ\text{C}$ $5.0\text{ mA} \leq I_O \leq 1.0\text{ A}$ $250\text{ mA} \leq I_O \leq 750\text{ mA}$	Reg_{load}	-	1.4 1.0 0.22	25 25 15	mV
Quiescent Current	I_B	-	3.3	6.0	mA
Quiescent Current Change $11\text{ Vdc} \leq V_{in} \leq 25\text{ Vdc}$, $I_O = 500\text{ mA}$ $10.6\text{ Vdc} \leq V_{in} \leq 23\text{ Vdc}$, $I_O = 1.0\text{ A}$, $T_J = 25^\circ\text{C}$ $5.0\text{ mA} \leq I_O \leq 1.0\text{ A}$	ΔI_B	-	-	0.8 0.8 0.5	mA
Ripple Rejection $11.5\text{ Vdc} \leq V_{in} \leq 21.5\text{ Vdc}$, $f = 120\text{ Hz}$, $I_O = 500\text{ mA}$	RR	56	62	-	dB
Dropout Voltage ($I_O = 1.0\text{ A}$, $T_J = 25^\circ\text{C}$)	$V_I - V_O$	-	2.0	-	Vdc
Output Noise Voltage ($T_A = 25^\circ\text{C}$) $10\text{ Hz} \leq f \leq 100\text{ kHz}$	V_n	-	10	-	$\mu\text{V}/V_O$
Output Resistance $f = 1.0\text{ kHz}$	r_O	-	0.9	-	$\text{m}\Omega$
Short Circuit Current Limit ($T_A = 25^\circ\text{C}$) $V_{in} = 35\text{ Vdc}$	I_{SC}	-	0.2	-	A
Peak Output Current ($T_J = 25^\circ\text{C}$)	I_{max}	-	2.2	-	A
Average Temperature Coefficient of Output Voltage	TCV_O	-	-0.4	-	$\text{mV}/^\circ\text{C}$

11. $T_{low} = 0^\circ\text{C}$ for MC78XXAC, C $T_{high} = +125^\circ\text{C}$ for MC78XXAC, C, NCV7805
 = -40°C for MC78XXB, MC78XXAB, NCV7805

12. Load and line regulation are specified at constant junction temperature. Changes in V_O due to heating effects must be taken into account separately. Pulse testing with low duty cycle is used.

MC7800, MC7800A, NCV7805

ELECTRICAL CHARACTERISTICS ($V_{in} = 15\text{ V}$, $I_O = 500\text{ mA}$, $T_J = T_{low}$ to T_{high} (Note 13), unless otherwise noted)

Characteristic	Symbol	MC7809B			MC7809C			Unit
		Min	Typ	Max	Min	Typ	Max	
Output Voltage ($T_J = 25^\circ\text{C}$)	V_O	8.65	9.0	9.35	8.65	9.0	9.35	Vdc
Output Voltage ($5.0\text{ mA} \leq I_O \leq 1.0\text{ A}$, $P_D \leq 15\text{ W}$) $11.5\text{ Vdc} \leq V_{in} \leq 24\text{ Vdc}$	V_O	8.55	9.0	9.45	8.55	9.0	9.45	Vdc
Line Regulation, $T_J = 25^\circ\text{C}$ (Note 14) $11\text{ Vdc} \leq V_{in} \leq 26\text{ Vdc}$ $11.5\text{ Vdc} \leq V_{in} \leq 17\text{ Vdc}$	Reg_{line}	-	6.2	32	-	6.2	32	mV
Load Regulation, $T_J = 25^\circ\text{C}$ (Note 14) $5.0\text{ mA} \leq I_O \leq 1.5\text{ A}$	Reg_{load}	-	1.5	35	-	1.5	35	mV
Quiescent Current	I_B	-	3.4	8.0	-	3.4	8.0	mA
Quiescent Current Change $11.5\text{ Vdc} \leq V_{in} \leq 26\text{ Vdc}$ $5.0\text{ mA} \leq I_O \leq 1.0\text{ A}$	ΔI_B	-	-	1.0	-	-	1.0	mA
Ripple Rejection $11.5\text{ Vdc} \leq V_{in} \leq 21.5\text{ Vdc}$, $f = 120\text{ Hz}$	RR	56	61	-	56	61	-	dB
Dropout Voltage ($I_O = 1.0\text{ A}$, $T_J = 25^\circ\text{C}$)	$V_I - V_O$	-	2.0	-	-	2.0	-	Vdc
Output Noise Voltage ($T_A = 25^\circ\text{C}$) $10\text{ Hz} \leq f \leq 100\text{ kHz}$	V_n	-	10	-	-	10	-	$\mu\text{V}/V_O$
Output Resistance $f = 1.0\text{ kHz}$	r_O	-	1.0	-	-	1.0	-	$\text{m}\Omega$
Short Circuit Current Limit ($T_A = 25^\circ\text{C}$) $V_{in} = 35\text{ Vdc}$	I_{SC}	-	0.2	-	-	0.2	-	A
Peak Output Current ($T_J = 25^\circ\text{C}$)	I_{max}	-	2.2	-	-	2.2	-	A
Average Temperature Coefficient of Output Voltage	TCV_O	-	-0.5	-	-	-0.5	-	$\text{mV}/^\circ\text{C}$

13. $T_{low} = 0^\circ\text{C}$ for MC78XXAC, C $T_{high} = +125^\circ\text{C}$ for MC78XXAC, C, NCV7805
 $= -40^\circ\text{C}$ for MC78XXB, MC78XXAB, NCV7805

14. Load and line regulation are specified at constant junction temperature. Changes in V_O due to heating effects must be taken into account separately. Pulse testing with low duty cycle is used.

MC7800, MC7800A, NCV7805

ELECTRICAL CHARACTERISTICS ($V_{in} = 15\text{ V}$, $I_O = 1.0\text{ A}$, $T_J = 0^\circ\text{C}$ to 125°C , unless otherwise noted)

Characteristic	Symbol	MC7809AC			Unit
		Min	Typ	Max	
Output Voltage ($T_J = 25^\circ\text{C}$)	V_O	8.82	9.0	9.18	Vdc
Output Voltage ($5.0\text{ mA} \leq I_O \leq 1.0\text{ A}$, $P_D \leq 15\text{ W}$) $11.5\text{ Vdc} \leq V_{in} \leq 24\text{ Vdc}$	V_O	8.65	9.0	9.35	Vdc
Line Regulation (Note 15) $11.5\text{ Vdc} \leq V_{in} \leq 26\text{ Vdc}$, $I_O = 500\text{ mA}$ $12\text{ Vdc} \leq V_{in} \leq 17\text{ Vdc}$, $I_O = 1.0\text{ A}$ $11.5\text{ Vdc} \leq V_{in} \leq 24\text{ Vdc}$, $T_J = 25^\circ\text{C}$	Regline	-	6.2	16	mV
Load Regulation (Note 15) $5.0\text{ mA} \leq I_O \leq 1.5\text{ A}$, $T_J = 25^\circ\text{C}$ $5.0\text{ mA} \leq I_O \leq 1.0\text{ A}$ $250\text{ mA} \leq I_O \leq 750\text{ mA}$	Regload	-	-	25	mV
Quiescent Current	I_B	-	3.3	6.0	mA
Quiescent Current Change $11.5\text{ Vdc} \leq V_{in} \leq 26\text{ Vdc}$, $I_O = 500\text{ mA}$ $11.5\text{ Vdc} \leq V_{in} \leq 24\text{ Vdc}$, $I_O = 1.0\text{ A}$, $T_J = 25^\circ\text{C}$ $5.0\text{ mA} \leq I_O \leq 1.0\text{ A}$	ΔI_B	-	-	0.8	mA
Ripple Rejection $11.5\text{ Vdc} \leq V_{in} \leq 21.5\text{ Vdc}$, $f = 120\text{ Hz}$, $I_O = 500\text{ mA}$	RR	56	61	-	dB
Dropout Voltage ($I_O = 1.0\text{ A}$, $T_J = 25^\circ\text{C}$)	V_{I_VO}		2.0		Vdc
Output Noise Voltage ($T_A = 25^\circ\text{C}$) $10\text{ Hz} \leq f \leq 100\text{ kHz}$	V_n	-	10	-	$\mu\text{V}/V_O$
Output Resistance $f = 1.0\text{ kHz}$	r_O	-	1.0	-	$\text{m}\Omega$
Short Circuit Current Limit ($T_A = 25^\circ\text{C}$) $V_{in} = 35\text{ Vdc}$	I_{SC}	-	0.2		A
Peak Output Current ($T_J = 25^\circ\text{C}$)	I_{max}	-	2.2	-	A
Average Temperature Coefficient of Output Voltage	TCV_O	-	-0.5	-	$\text{mV}/^\circ\text{C}$

15. Load and line regulation are specified at constant junction temperature. Changes in V_O due to heating effects must be taken into account separately. Pulse testing with low duty cycle is used.

MC7800, MC7800A, NCV7805

ELECTRICAL CHARACTERISTICS ($V_{in} = 19\text{ V}$, $I_O = 500\text{ mA}$, $T_J = T_{low}$ to T_{high} (Note 16), unless otherwise noted)

Characteristic	Symbol	MC7812B			MC7812C			Unit
		Min	Typ	Max	Min	Typ	Max	
Output Voltage ($T_J = 25^\circ\text{C}$)	V_O	11.5	12	12.5	11.5	12	12.5	Vdc
Output Voltage ($5.0\text{ mA} \leq I_O \leq 1.0\text{ A}$, $P_D \leq 15\text{ W}$)	V_O							Vdc
$14.5\text{ Vdc} \leq V_{in} \leq 27\text{ Vdc}$		-	-	-	11.4	12	12.6	
$15.5\text{ Vdc} \leq V_{in} \leq 27\text{ Vdc}$		11.4	12	12.6	-	-	-	
Line Regulation, $T_J = 25^\circ\text{C}$ (Note 17)	Reg_{line}							mV
$14.5\text{ Vdc} \leq V_{in} \leq 30\text{ Vdc}$		-	7.5	240	-	3.8	24	
$16\text{ Vdc} \leq V_{in} \leq 22\text{ Vdc}$		-	2.2	120	-	0.3	24	
$14.8\text{ Vdc} \leq V_{in} \leq 27\text{ Vdc}$, $I_O = 1.0\text{ A}$		-	-	-	-	-	48	
Load Regulation, $T_J = 25^\circ\text{C}$ (Note 17)	Reg_{load}	-	1.6	240	-	8.1	60	mV
$5.0\text{ mA} \leq I_O \leq 1.5\text{ A}$								
Quiescent Current	I_B	-	3.4	8.0	-	3.4	6.5	mA
Quiescent Current Change	ΔI_B							mA
$14.5\text{ Vdc} \leq V_{in} \leq 30\text{ Vdc}$, $I_O = 1.0\text{ A}$, $T_J = 25^\circ\text{C}$		-	-	-	-	-	0.7	
$15\text{ Vdc} \leq V_{in} \leq 30\text{ Vdc}$		-	-	1.0	-	-	0.8	
$5.0\text{ mA} \leq I_O \leq 1.0\text{ A}$		-	-	0.5	-	-	0.5	
Ripple Rejection	RR	-	60	-	55	60	-	dB
$15\text{ Vdc} \leq V_{in} \leq 25\text{ Vdc}$, $f = 120\text{ Hz}$								
Dropout Voltage ($I_O = 1.0\text{ A}$, $T_J = 25^\circ\text{C}$)	$V_I - V_O$	-	2.0	-	-	2.0	-	Vdc
Output Noise Voltage ($T_A = 25^\circ\text{C}$)	V_n	-	10	-	-	10	-	$\mu\text{V}/V_O$
$10\text{ Hz} \leq f \leq 100\text{ kHz}$								
Output Resistance $f = 1.0\text{ kHz}$	r_O	-	1.1	-	-	1.1	-	$\text{m}\Omega$
Short Circuit Current Limit ($T_A = 25^\circ\text{C}$)	I_{SC}	-	0.2	-	-	0.2	-	A
$V_{in} = 35\text{ Vdc}$								
Peak Output Current ($T_J = 25^\circ\text{C}$)	I_{max}	-	2.2	-	-	2.2	-	A
Average Temperature Coefficient of Output Voltage	TCV_O	-	-0.8	-	-	-0.8	-	$\text{mV}/^\circ\text{C}$

16. $T_{low} = 0^\circ\text{C}$ for MC78XXAC, C $T_{high} = +125^\circ\text{C}$ for MC78XXAC, C, NCV7805
 = -40°C for MC78XXB, MC78XXAB, NCV7805

17. Load and line regulation are specified at constant junction temperature. Changes in V_O due to heating effects must be taken into account separately. Pulse testing with low duty cycle is used.

MC7800, MC7800A, NCV7805

ELECTRICAL CHARACTERISTICS ($V_{in} = 19\text{ V}$, $I_O = 1.0\text{ A}$, $T_J = T_{low}$ to T_{high} (Note 18), unless otherwise noted)

Characteristic	Symbol	MC7812AB/MC7812AC			Unit
		Min	Typ	Max	
Output Voltage ($T_J = 25^\circ\text{C}$)	V_O	11.75	12	12.25	Vdc
Output Voltage ($5.0\text{ mA} \leq I_O \leq 1.0\text{ A}$, $P_D \leq 15\text{ W}$) $14.8\text{ Vdc} \leq V_{in} \leq 27\text{ Vdc}$	V_O	11.5	12	12.5	Vdc
Line Regulation (Note 19) $14.8\text{ Vdc} \leq V_{in} \leq 30\text{ Vdc}$, $I_O = 500\text{ mA}$ $16\text{ Vdc} \leq V_{in} \leq 22\text{ Vdc}$, $I_O = 1.0\text{ A}$ $14.5\text{ Vdc} \leq V_{in} \leq 27\text{ Vdc}$, $T_J = 25^\circ\text{C}$	Reg_{line}	-	3.8	18	mV
Load Regulation (Note 19) $5.0\text{ mA} \leq I_O \leq 1.5\text{ A}$, $T_J = 25^\circ\text{C}$ $5.0\text{ mA} \leq I_O \leq 1.0\text{ A}$	Reg_{load}	-	-	25	mV
Quiescent Current	I_B	-	3.4	6.0	mA
Quiescent Current Change $15\text{ Vdc} \leq V_{in} \leq 30\text{ Vdc}$, $I_O = 500\text{ mA}$ $14.8\text{ Vdc} \leq V_{in} \leq 27\text{ Vdc}$, $T_J = 25^\circ\text{C}$ $5.0\text{ mA} \leq I_O \leq 1.0\text{ A}$, $T_J = 25^\circ\text{C}$	ΔI_B	-	-	0.8	mA
Ripple Rejection $15\text{ Vdc} \leq V_{in} \leq 25\text{ Vdc}$, $f = 120\text{ Hz}$, $I_O = 500\text{ mA}$	RR	55	60	-	dB
Dropout Voltage ($I_O = 1.0\text{ A}$, $T_J = 25^\circ\text{C}$)	$V_I - V_O$	-	2.0	-	Vdc
Output Noise Voltage ($T_A = 25^\circ\text{C}$) $10\text{ Hz} \leq f \leq 100\text{ kHz}$	V_n	-	10	-	$\mu\text{V}/V_O$
Output Resistance ($f = 1.0\text{ kHz}$)	r_O	-	1.1	-	$\text{m}\Omega$
Short Circuit Current Limit ($T_A = 25^\circ\text{C}$) $V_{in} = 35\text{ Vdc}$	I_{SC}	-	0.2	-	A
Peak Output Current ($T_J = 25^\circ\text{C}$)	I_{max}	-	2.2	-	A
Average Temperature Coefficient of Output Voltage	TCV_O	-	-0.8	-	$\text{mV}/^\circ\text{C}$

18. $T_{low} = 0^\circ\text{C}$ for MC78XXAC, C $T_{high} = +125^\circ\text{C}$ for MC78XXAC, C, NCV7805
 $= -40^\circ\text{C}$ for MC78XXB, MC78XXAB, NCV7805

19. Load and line regulation are specified at constant junction temperature. Changes in V_O due to heating effects must be taken into account separately. Pulse testing with low duty cycle is used.

MC7800, MC7800A, NCV7805

ELECTRICAL CHARACTERISTICS ($V_{in} = 23\text{ V}$, $I_O = 500\text{ mA}$, $T_J = T_{low}$ to T_{high} (Note 20), unless otherwise noted)

Characteristic	Symbol	MC7815B			MC7815C			Unit
		Min	Typ	Max	Min	Typ	Max	
Output Voltage ($T_J = 25^\circ\text{C}$)	V_O	14.4	15	15.6	14.4	15	15.6	Vdc
Output Voltage ($5.0\text{ mA} \leq I_O \leq 1.0\text{ A}$, $P_D \leq 15\text{ W}$)	V_O							Vdc
$17.5\text{ Vdc} \leq V_{in} \leq 30\text{ Vdc}$		-	-	-	14.25	15	15.75	
$18.5\text{ Vdc} \leq V_{in} \leq 30\text{ Vdc}$		14.25	15	15.75	-	-	-	
Line Regulation, $T_J = 25^\circ\text{C}$ (Note 21)	Reg_{line}							mV
$17.9\text{ Vdc} \leq V_{in} \leq 30\text{ Vdc}$		-	8.5	300	-	8.5	30	
$20\text{ Vdc} \leq V_{in} \leq 26\text{ Vdc}$		-	3.0	150	-	3.0	28	
Load Regulation, $T_J = 25^\circ\text{C}$ (Note 21)	Reg_{load}	-	1.8	300	-	1.8	55	mV
$5.0\text{ mA} \leq I_O \leq 1.5\text{ A}$								
Quiescent Current	I_B	-	3.5	8.0	-	3.5	6.5	mA
Quiescent Current Change	ΔI_B							mA
$17.5\text{ Vdc} \leq V_{in} \leq 30\text{ Vdc}$		-	-	-	-	-	0.8	
$17.5\text{ Vdc} \leq V_{in} \leq 30\text{ Vdc}$, $I_O = 1.0\text{ A}$, $T_J = 25^\circ\text{C}$		-	-	1.0	-	-	0.7	
$5.0\text{ mA} \leq I_O \leq 1.0\text{ A}$		-	-	0.5	-	-	0.5	
Ripple Rejection	RR	-	58	-	54	58	-	dB
$18.5\text{ Vdc} \leq V_{in} \leq 28.5\text{ Vdc}$, $f = 120\text{ Hz}$								
Dropout Voltage ($I_O = 1.0\text{ A}$, $T_J = 25^\circ\text{C}$)	$V_I - V_O$	-	2.0	-	-	2.0	-	Vdc
Output Noise Voltage ($T_A = 25^\circ\text{C}$)	V_n	-	10	-	-	10	-	$\mu\text{V}/V_O$
$10\text{ Hz} \leq f \leq 100\text{ kHz}$								
Output Resistance $f = 1.0\text{ kHz}$	r_O	-	1.2	-	-	1.2	-	$\text{m}\Omega$
Short Circuit Current Limit ($T_A = 25^\circ\text{C}$)	I_{SC}	-	0.2	-	-	0.2	-	A
$V_{in} = 35\text{ Vdc}$								
Peak Output Current ($T_J = 25^\circ\text{C}$)	I_{max}	-	2.2	-	-	2.2	-	A
Average Temperature Coefficient of Output Voltage	TCV_O	-	-1.0	-	-	-1.0	-	$\text{mV}/^\circ\text{C}$

20. $T_{low} = 0^\circ\text{C}$ for MC78XXAC, C $T_{high} = +125^\circ\text{C}$ for MC78XXAC, C, NCV7805
 = -40°C for MC78XXB, MC78XXAB, NCV7805

21. Load and line regulation are specified at constant junction temperature. Changes in V_O due to heating effects must be taken into account separately. Pulse testing with low duty cycle is used.

MC7800, MC7800A, NCV7805

ELECTRICAL CHARACTERISTICS ($V_{in} = 23\text{ V}$, $I_O = 1.0\text{ A}$, $T_J = T_{low}$ to T_{high} (Note 22), unless otherwise noted)

Characteristic	Symbol	MC7815AB/MC7815AC			Unit
		Min	Typ	Max	
Output Voltage ($T_J = 25^\circ\text{C}$)	V_O	14.7	15	15.3	Vdc
Output Voltage ($5.0\text{ mA} \leq I_O \leq 1.0\text{ A}$, $P_D \leq 15\text{ W}$) $17.9\text{ Vdc} \leq V_{in} \leq 30\text{ Vdc}$	V_O	14.4	15	15.6	Vdc
Line Regulation (Note 23) $17.9\text{ Vdc} \leq V_{in} \leq 30\text{ Vdc}$, $I_O = 500\text{ mA}$ $20\text{ Vdc} \leq V_{in} \leq 26\text{ Vdc}$ $17.5\text{ Vdc} \leq V_{in} \leq 30\text{ Vdc}$, $I_O = 1.0\text{ A}$, $T_J = 25^\circ\text{C}$	Reg_{line}	-	8.5 3.0 7.0	20 22 20	mV
Load Regulation (Note 23) $5.0\text{ mA} \leq I_O \leq 1.5\text{ A}$, $T_J = 25^\circ\text{C}$ $5.0\text{ mA} \leq I_O \leq 1.0\text{ A}$ $250\text{ mA} \leq I_O \leq 750\text{ mA}$	Reg_{load}	-	1.8 1.5 1.2	25 25 15	mV
Quiescent Current	I_B	-	3.5	6.0	mA
Quiescent Current Change $17.5\text{ Vdc} \leq V_{in} \leq 30\text{ Vdc}$, $I_O = 500\text{ mA}$ $17.5\text{ Vdc} \leq V_{in} \leq 30\text{ Vdc}$, $I_O = 1.0\text{ A}$, $T_J = 25^\circ\text{C}$ $5.0\text{ mA} \leq I_O \leq 1.0\text{ A}$	ΔI_B	-	-	0.8 0.8 0.5	mA
Ripple Rejection $18.5\text{ Vdc} \leq V_{in} \leq 28.5\text{ Vdc}$, $f = 120\text{ Hz}$, $I_O = 500\text{ mA}$	RR	60	80	-	dB
Dropout Voltage ($I_O = 1.0\text{ A}$, $T_J = 25^\circ\text{C}$)	$V_I - V_O$	-	2.0	-	Vdc
Output Noise Voltage ($T_A = 25^\circ\text{C}$) $10\text{ Hz} \leq f \leq 100\text{ kHz}$	V_n	-	10	-	$\mu\text{V}/V_O$
Output Resistance $f = 1.0\text{ kHz}$	r_O	-	1.2	-	$\text{m}\Omega$
Short Circuit Current Limit ($T_A = 25^\circ\text{C}$) $V_{in} = 35\text{ Vdc}$	I_{SC}	-	0.2	-	A
Peak Output Current ($T_J = 25^\circ\text{C}$)	I_{max}	-	2.2	-	A
Average Temperature Coefficient of Output Voltage	TCV_O	-	-1.0	-	$\text{mV}/^\circ\text{C}$

22. $T_{low} = 0^\circ\text{C}$ for MC78XXAC, C $T_{high} = +125^\circ\text{C}$ for MC78XXAC, C, NCV7805
 $= -40^\circ\text{C}$ for MC78XXB, MC78XXAB, NCV7805

23. Load and line regulation are specified at constant junction temperature. Changes in V_O due to heating effects must be taken into account separately. Pulse testing with low duty cycle is used.

MC7800, MC7800A, NCV7805

ELECTRICAL CHARACTERISTICS ($V_{in} = 27\text{ V}$, $I_O = 500\text{ mA}$, $T_J = T_{low}$ to T_{high} (Note 24), unless otherwise noted)

Characteristic	Symbol	MC7818B			MC7818C			Unit
		Min	Typ	Max	Min	Typ	Max	
Output Voltage ($T_J = 25^\circ\text{C}$)	V_O	17.3	18	18.7	17.3	18	18.7	Vdc
Output Voltage ($5.0\text{ mA} \leq I_O \leq 1.0\text{ A}$, $P_D \leq 15\text{ W}$)	V_O							Vdc
21 Vdc $\leq V_{in} \leq 33\text{ Vdc}$		-	-	-	17.1	18	18.9	
22 Vdc $\leq V_{in} \leq 33\text{ Vdc}$		17.1	18	18.9	-	-	-	
Line Regulation, (Note 25)	Reg_{line}							mV
21 Vdc $\leq V_{in} \leq 33\text{ Vdc}$		-	9.5	360	-	9.5	50	
24 Vdc $\leq V_{in} \leq 30\text{ Vdc}$		-	3.2	180	-	3.2	25	
Load Regulation, (Note 25)	Reg_{load}							mV
5.0 mA $\leq I_O \leq 1.5\text{ A}$		-	2.0	360	-	2.0	55	
Quiescent Current	I_B	-	3.5	8.0	-	3.5	6.5	mA
Quiescent Current Change	ΔI_B							mA
21 Vdc $\leq V_{in} \leq 33\text{ Vdc}$		-	-	-	-	-	1.0	
5.0 mA $\leq I_O \leq 1.0\text{ A}$		-	-	0.5	-	-	0.5	
Ripple Rejection	RR							dB
22 Vdc $\leq V_{in} \leq 33\text{ Vdc}$, $f = 120\text{ Hz}$		-	57	-	53	57	-	
Dropout Voltage ($I_O = 1.0\text{ A}$, $T_J = 25^\circ\text{C}$)	$V_{il} - V_O$	-	2.0	-	-	2.0	-	Vdc
Output Noise Voltage ($T_A = 25^\circ\text{C}$)	V_n							$\mu\text{V}/V_O$
10 Hz $\leq f \leq 100\text{ kHz}$		-	10	-	-	10	-	
Output Resistance $f = 1.0\text{ kHz}$	r_O	-	1.3	-	-	1.3	-	$\text{m}\Omega$
Short Circuit Current Limit ($T_A = 25^\circ\text{C}$)	I_{SC}							A
$V_{in} = 35\text{ Vdc}$		-	0.2	-	-	0.2	-	
Peak Output Current ($T_J = 25^\circ\text{C}$)	I_{max}	-	2.2	-	-	2.2	-	A
Average Temperature Coefficient of Output Voltage	TCV_O	-	-1.5	-	-	-1.5	-	$\text{mV}/^\circ\text{C}$

24. $T_{low} = 0^\circ\text{C}$ for MC78XXAC, C $T_{high} = +125^\circ\text{C}$ for MC78XXAC, C, NCV7805
 = -40°C for MC78XXB, MC78XXAB, NCV7805

25. Load and line regulation are specified at constant junction temperature. Changes in V_O due to heating effects must be taken into account separately. Pulse testing with low duty cycle is used.

MC7800, MC7800A, NCV7805

ELECTRICAL CHARACTERISTICS ($V_{in} = 27\text{ V}$, $I_O = 1.0\text{ A}$, $T_J = T_{low}$ to T_{high} (Note 26), unless otherwise noted)

Characteristic	Symbol	MC7818AC			Unit
		Min	Typ	Max	
Output Voltage ($T_J = 25^\circ\text{C}$)	V_O	17.64	18	18.36	Vdc
Output Voltage ($5.0\text{ mA} \leq I_O \leq 1.0\text{ A}$, $P_D \leq 15\text{ W}$) $21\text{ Vdc} \leq V_{in} \leq 33\text{ Vdc}$	V_O	17.3	18	18.7	Vdc
Line Regulation (Note 27) $21\text{ Vdc} \leq V_{in} \leq 33\text{ Vdc}$, $I_O = 500\text{ mA}$ $24\text{ Vdc} \leq V_{in} \leq 30\text{ Vdc}$, $I_O = 1.0\text{ A}$ $24\text{ Vdc} \leq V_{in} \leq 30\text{ Vdc}$, $I_O = 1.0\text{ A}$, $T_J = 25^\circ\text{C}$ $20.6\text{ Vdc} \leq V_{in} \leq 33\text{ Vdc}$, $I_O = 1.0\text{ A}$, $T_J = 25^\circ\text{C}$	Reg_{line}	-	9.5 3.2 3.2 8.0	22 25 10.5 22	mV
Load Regulation (Note 27) $5.0\text{ mA} \leq I_O \leq 1.5\text{ A}$, $T_J = 25^\circ\text{C}$ $5.0\text{ mA} \leq I_O \leq 1.0\text{ A}$ $250\text{ mA} \leq I_O \leq 750\text{ mA}$	Reg_{load}	-	2.0 1.8 1.5	25 25 15	mV
Quiescent Current	I_B	-	3.5	6.0	mA
Quiescent Current Change $21\text{ Vdc} \leq V_{in} \leq 33\text{ Vdc}$, $I_O = 500\text{ mA}$ $21.5\text{ Vdc} \leq V_{in} \leq 30\text{ Vdc}$, $T_J = 25^\circ\text{C}$ $5.0\text{ mA} \leq I_O \leq 1.0\text{ A}$	ΔI_B	-	-	0.8 0.8 0.5	mA
Ripple Rejection $22\text{ Vdc} \leq V_{in} \leq 32\text{ Vdc}$, $f = 120\text{ Hz}$, $I_O = 500\text{ mA}$	RR	53	57	-	dB
Dropout Voltage ($I_O = 1.0\text{ A}$, $T_J = 25^\circ\text{C}$)	$V_I - V_O$	-	2.0	-	Vdc
Output Noise Voltage ($T_A = 25^\circ\text{C}$) $10\text{ Hz} \leq f \leq 100\text{ kHz}$	V_n	-	10	-	$\mu\text{V}/V_O$
Output Resistance $f = 1.0\text{ kHz}$	r_O	-	1.3	-	$\text{m}\Omega$
Short Circuit Current Limit ($T_A = 25^\circ\text{C}$) $V_{in} = 35\text{ Vdc}$	I_{SC}	-	0.2	-	A
Peak Output Current ($T_J = 25^\circ\text{C}$)	I_{max}	-	2.2	-	A
Average Temperature Coefficient of Output Voltage	TCV_O	-	-1.5	-	$\text{mV}/^\circ\text{C}$

26. $T_{low} = 0^\circ\text{C}$ for MC78XXAC, C $T_{high} = +125^\circ\text{C}$ for MC78XXAC, C, NCV7805
= -40°C for MC78XXB, MC78XXAB, NCV7805

27. Load and line regulation are specified at constant junction temperature. Changes in V_O due to heating effects must be taken into account separately. Pulse testing with low duty cycle is used.

MC7800, MC7800A, NCV7805

ELECTRICAL CHARACTERISTICS ($V_{in} = 33\text{ V}$, $I_O = 500\text{ mA}$, $T_J = T_{low}$ to T_{high} (Note 28), unless otherwise noted)

Characteristic	Symbol	MC7824B			MC7824C			Unit
		Min	Typ	Max	Min	Typ	Max	
Output Voltage ($T_J = 25^\circ\text{C}$)	V_O	23	24	25	23	24	25	Vdc
Output Voltage ($5.0\text{ mA} \leq I_O \leq 1.0\text{ A}$, $P_D \leq 15\text{ W}$)	V_O							Vdc
27 Vdc $\leq V_{in} \leq 38\text{ Vdc}$		-	-	-	22.8	24	25.2	
28 Vdc $\leq V_{in} \leq 38\text{ Vdc}$		22.8	24	25.2	-	-	-	
Line Regulation, (Note 29)	Reg_{line}							mV
27 Vdc $\leq V_{in} \leq 38\text{ Vdc}$		-	11.5	480	-	2.7	60	
30 Vdc $\leq V_{in} \leq 36\text{ Vdc}$		-	3.8	240	-	2.7	48	
Load Regulation, (Note 29)	Reg_{load}	-	2.1	480	-	4.4	65	mV
5.0 mA $\leq I_O \leq 1.5\text{ A}$								
Quiescent Current	I_B	-	3.6	8.0	-	3.6	6.5	mA
Quiescent Current Change	ΔI_B							mA
27 Vdc $\leq V_{in} \leq 38\text{ Vdc}$		-	-	-	-	-	1.0	
5.0 mA $\leq I_O \leq 1.0\text{ A}$		-	-	0.5	-	-	0.5	
Ripple Rejection	RR	-	54	-	50	54	-	dB
28 Vdc $\leq V_{in} \leq 38\text{ Vdc}$, $f = 120\text{ Hz}$								
Dropout Voltage ($I_O = 1.0\text{ A}$, $T_J = 25^\circ\text{C}$)	$V_I - V_O$	-	2.0	-	-	2.0	-	Vdc
Output Noise Voltage ($T_A = 25^\circ\text{C}$)	V_n	-	10	-	-	10	-	$\mu\text{V}/V_O$
10 Hz $\leq f \leq 100\text{ kHz}$								
Output Resistance $f = 1.0\text{ kHz}$	r_O	-	1.4	-	-	1.4	-	$\text{m}\Omega$
Short Circuit Current Limit ($T_A = 25^\circ\text{C}$)	I_{SC}	-	0.2	-	-	0.2	-	A
$V_{in} = 35\text{ Vdc}$								
Peak Output Current ($T_J = 25^\circ\text{C}$)	I_{max}	-	2.2	-	-	2.2	-	A
Average Temperature Coefficient of Output Voltage	TCV_O	-	-2.0	-	-	-2.0	-	$\text{mV}/^\circ\text{C}$

28. $T_{low} = 0^\circ\text{C}$ for MC78XXAC, C $T_{high} = +125^\circ\text{C}$ for MC78XXAC, C, NCV7805
 $= -40^\circ\text{C}$ for MC78XXB, MC78XXAB, NCV7805

29. Load and line regulation are specified at constant junction temperature. Changes in V_O due to heating effects must be taken into account separately. Pulse testing with low duty cycle is used.

MC7800, MC7800A, NCV7805

ELECTRICAL CHARACTERISTICS ($V_{in} = 33\text{ V}$, $I_O = 1.0\text{ A}$, $T_J = T_{low}$ to T_{high} (Note 30), unless otherwise noted)

Characteristic	Symbol	MC7824AC			Unit
		Min	Typ	Max	
Output Voltage ($T_J = 25^\circ\text{C}$)	V_O	23.5	24	24.5	Vdc
Output Voltage ($5.0\text{ mA} \leq I_O \leq 1.0\text{ A}$, $P_D \leq 15\text{ W}$) $27.3\text{ Vdc} \leq V_{in} \leq 38\text{ Vdc}$	V_O	23.2	24	25.8	Vdc
Line Regulation (Note 31) $27\text{ Vdc} \leq V_{in} \leq 38\text{ Vdc}$, $I_O = 500\text{ mA}$ $30\text{ Vdc} \leq V_{in} \leq 36\text{ Vdc}$, $I_O = 1.0\text{ A}$ $30\text{ Vdc} \leq V_{in} \leq 36\text{ Vdc}$, $T_J = 25^\circ\text{C}$ $26.7\text{ Vdc} \leq V_{in} \leq 38\text{ Vdc}$, $I_O = 1.0\text{ A}$, $T_J = 25^\circ\text{C}$	Reg_{line}	-	11.5 3.8 3.8 10	25 28 12 25	mV
Load Regulation (Note 31) $5.0\text{ mA} \leq I_O \leq 1.5\text{ A}$, $T_J = 25^\circ\text{C}$ $5.0\text{ mA} \leq I_O \leq 1.0\text{ A}$ $250\text{ mA} \leq I_O \leq 750\text{ mA}$	Reg_{load}	-	2.1 2.0 1.8	15 25 15	mV
Quiescent Current	I_B	-	3.6	6.0	mA
Quiescent Current Change $27.3\text{ Vdc} \leq V_{in} \leq 38\text{ Vdc}$, $I_O = 500\text{ mA}$ $27\text{ Vdc} \leq V_{in} \leq 38\text{ Vdc}$, $T_J = 25^\circ\text{C}$ $5.0\text{ mA} \leq I_O \leq 1.0\text{ A}$	ΔI_B	-	-	0.8 0.8 0.5	mA
Ripple Rejection $28\text{ Vdc} \leq V_{in} \leq 38\text{ Vdc}$, $f = 120\text{ Hz}$, $I_O = 500\text{ mA}$	RR	45	54	-	dB
Dropout Voltage ($I_O = 1.0\text{ A}$, $T_J = 25^\circ\text{C}$)	$V_I - V_O$	-	2.0	-	Vdc
Output Noise Voltage ($T_A = 25^\circ\text{C}$) $10\text{ Hz} \leq f \leq 100\text{ kHz}$	V_n	-	10	-	$\mu\text{V}/V_O$
Output Resistance ($f = 1.0\text{ kHz}$)	r_O	-	1.4	-	$\text{m}\Omega$
Short Circuit Current Limit ($T_A = 25^\circ\text{C}$) $V_{in} = 35\text{ Vdc}$	I_{SC}	-	0.2	-	A
Peak Output Current ($T_J = 25^\circ\text{C}$)	I_{max}	-	2.2	-	A
Average Temperature Coefficient of Output Voltage	TCV_O	-	-2.0	-	$\text{mV}/^\circ\text{C}$

30. $T_{low} = 0^\circ\text{C}$ for MC78XXAC, C $T_{high} = +125^\circ\text{C}$ for MC78XXAC, C, NCV7805
= -40°C for MC78XXB, MC78XXAB, NCV7805

31. Load and line regulation are specified at constant junction temperature. Changes in V_O due to heating effects must be taken into account separately. Pulse testing with low duty cycle is used.

MC7800, MC7800A, NCV7805

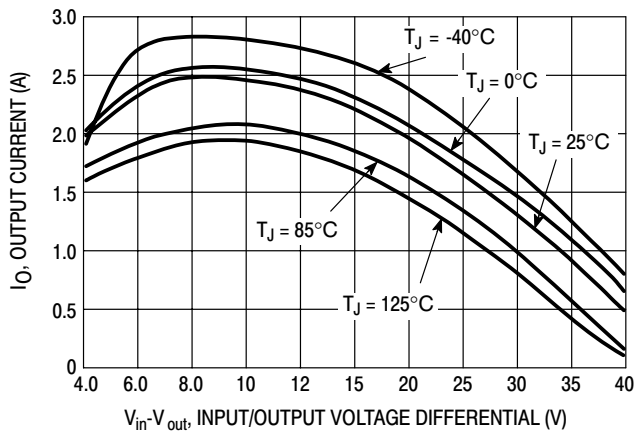

Figure 2. Peak Output Current as a Function of Input/Output Differential Voltage (MC78XXC, AC, B)

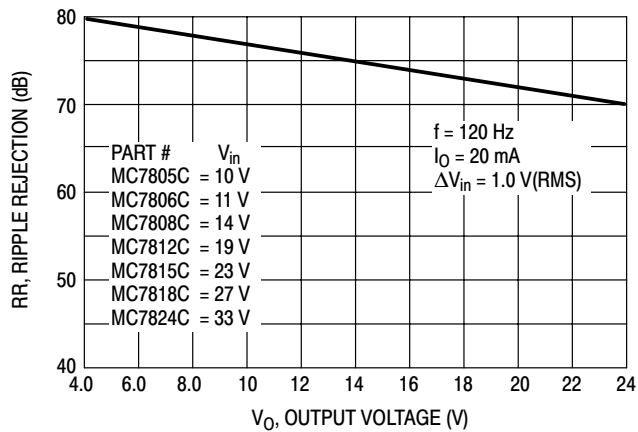

Figure 3. Ripple Rejection as a Function of Output Voltages (MC78XXC, AC, B)

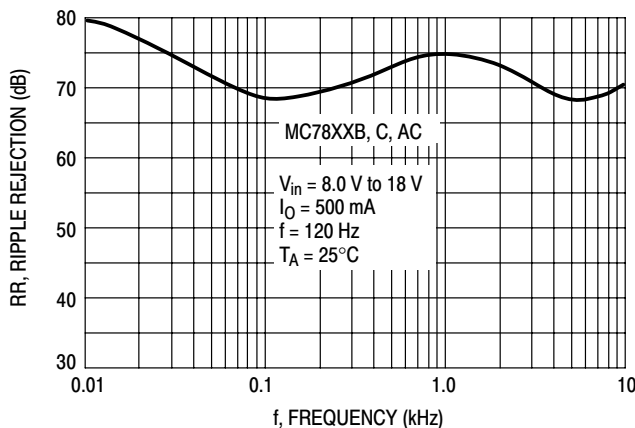

Figure 4. Ripple Rejection as a Function of Frequency (MC78XXC, AC, B)

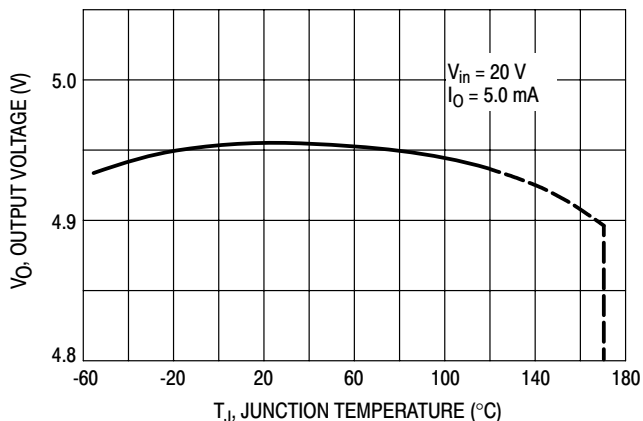

Figure 5. Output Voltage as a Function of Junction Temperature (MC7805C, AC, B)

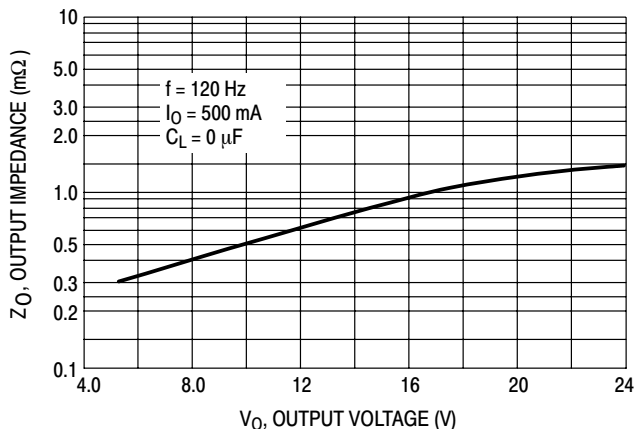

Figure 6. Output Impedance as a Function of Output Voltage (MC78XXC, AC, B)

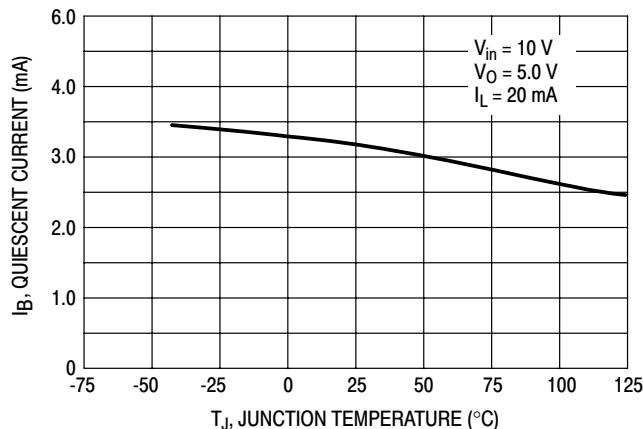

Figure 7. Quiescent Current as a Function of Temperature (MC78XXC, AC, B)

APPLICATIONS INFORMATION

Design Considerations

The MC7800 Series of fixed voltage regulators are designed with Thermal Overload Protection that shuts down the circuit when subjected to an excessive power overload condition, Internal Short Circuit Protection that limits the maximum current the circuit will pass, and Output Transistor Safe- Area Compensation that reduces the output short circuit current as the voltage across the pass transistor is increased.

In many low current applications, compensation capacitors are not required. However, it is recommended that the regulator input be bypassed with a capacitor if the regulator is connected to the power supply filter with long

wire lengths, or if the output load capacitance is large. An input bypass capacitor should be selected to provide good high-frequency characteristics to insure stable operation under all load conditions. A 0.33 μF or larger tantalum, mylar, or other capacitor having low internal impedance at high frequencies should be chosen. The bypass capacitor should be mounted with the shortest possible leads directly across the regulators input terminals. Normally good construction techniques should be used to minimize ground loops and lead resistance drops since the regulator has no external sense lead.

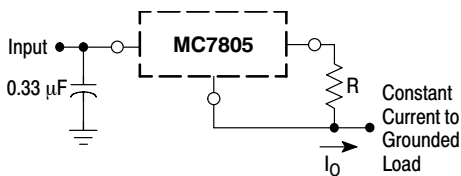

The MC7800 regulators can also be used as a current source when connected as above. In order to minimize dissipation the MC7805C is chosen in this application. Resistor R determines the current as follows:

$$I_O = \frac{5.0 V}{R} + I_B$$

$I_B \cong 3.2 \text{ mA}$ over line and load changes.

For example, a 1.0 A current source would require R to be a 5.0 Ω, 10 W resistor and the output voltage compliance would be the input voltage less 7.0 V.

Figure 8. Current Regulator

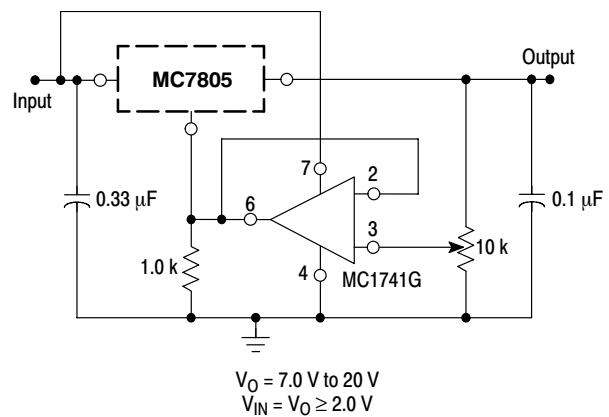

$V_O = 7.0 \text{ V to } 20 \text{ V}$
 $V_{IN} = V_O \geq 2.0 \text{ V}$

The addition of an operational amplifier allows adjustment to higher or intermediate values while retaining regulation characteristics. The minimum voltage obtainable with this arrangement is 2.0 V greater than the regulator voltage.

Figure 9. Adjustable Output Regulator

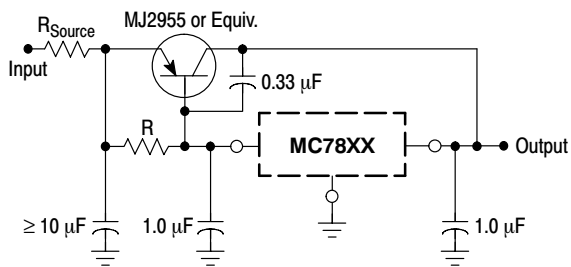

XX = 2 digits of type number indicating voltage.

The MC7800 series can be current boosted with a PNP transistor. The MJ2955 provides current to 5.0 A. Resistor R in conjunction with the V_{BE} of the PNP determines when the pass transistor begins conducting; this circuit is not short circuit proof. Input/output differential voltage minimum is increased by V_{BE} of the pass transistor.

Figure 10. Current Boost Regulator

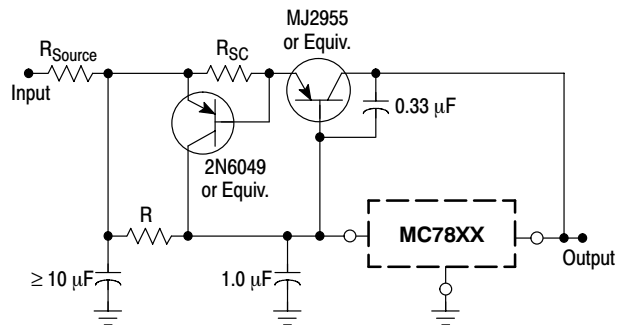

XX = 2 digits of type number indicating voltage.

The circuit of Figure 10 can be modified to provide supply protection against short circuits by adding a short circuit sense resistor, R_{SC} , and an additional PNP transistor. The current sensing PNP must be able to handle the short circuit current of the three-terminal regulator. Therefore, a four-ampere plastic power transistor is specified.

Figure 11. Short Circuit Protection

MC7800, MC7800A, NCV7805

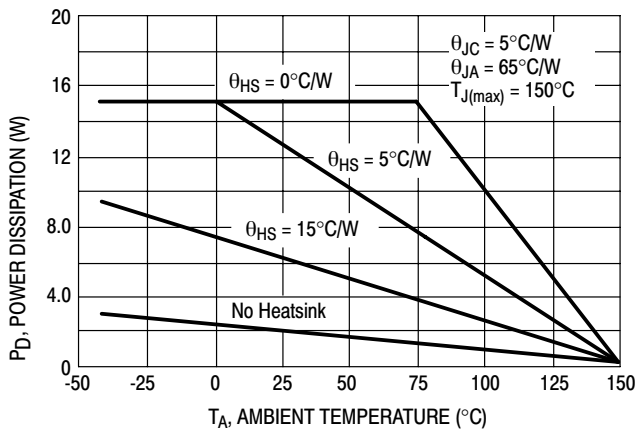

Figure 12. Worst Case Power Dissipation versus Ambient Temperature (Case 221A)

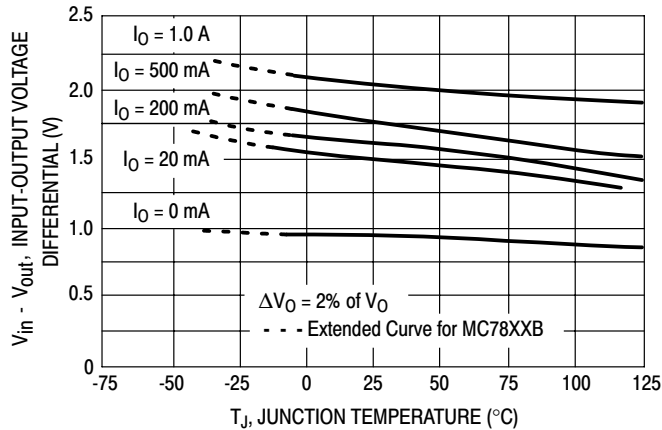

Figure 13. Input Output Differential as a Function of Junction Temperature (MC78XXC, AC, B)

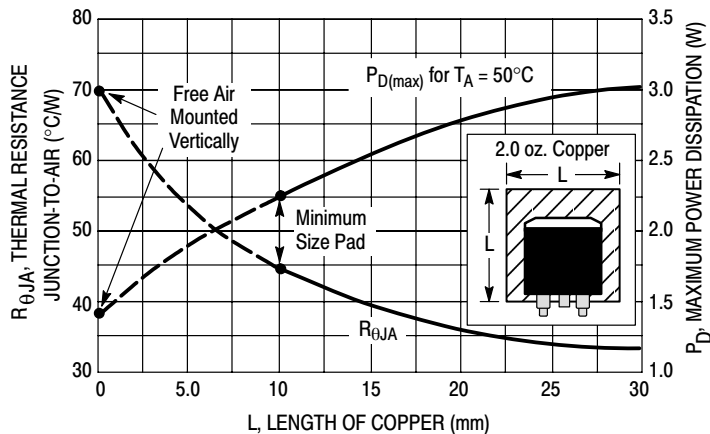

Figure 14. D²PAK Thermal Resistance and Maximum Power Dissipation versus P.C.B. Copper Length

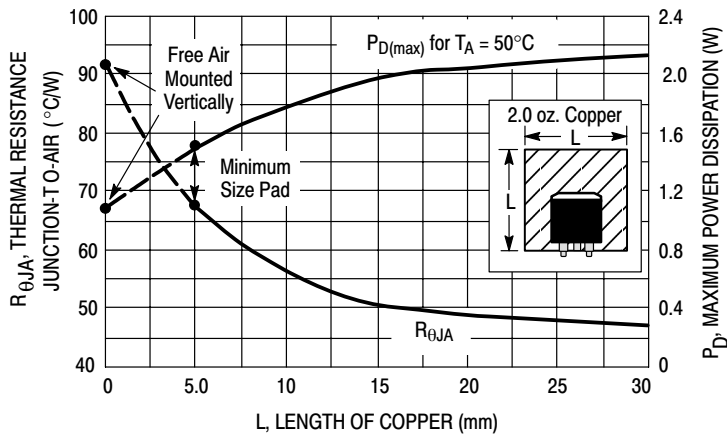

Figure 15. DPAK Thermal Resistance and Maximum Power Dissipation versus P.C.B. Copper Length

MC7800, MC7800A, NCV7805

DEFINITIONS

Line Regulation - The change in output voltage for a change in the input voltage. The measurement is made under conditions of low dissipation or by using pulse techniques such that the average chip temperature is not significantly affected.

Load Regulation - The change in output voltage for a change in load current at constant chip temperature.

Maximum Power Dissipation - The maximum total device dissipation for which the regulator will operate within specifications.

Quiescent Current - That part of the input current that is not delivered to the load.

Output Noise Voltage - The rms ac voltage at the output, with constant load and no input ripple, measured over a specified frequency range.

Long Term Stability - Output voltage stability under accelerated life test conditions with the maximum rated voltage listed in the devices' electrical characteristics and maximum power dissipation.

ORDERING INFORMATION

Device	Nominal Voltage	Operating Temperature Range	Package	Shipping [†]
MC7805ABD2T	5.0 V	T = -40°C to +125°C	D ² PAK	50 Units /Rail
MC7805ABD2TG			D ² PAK (Pb-free)	50 Units /Rail
MC7805ABD2TR4			D ² PAK	800 / Tape & Reel
MC7805ABD2TR4G			D ² PAK (Pb-free)	800 / Tape & Reel
MC7805ABT			TO 220	50 Units /Rail
MC7805ABTG			TO 220 (Pb-free)	50 Units /Rail
MC7805ACD2T		T = 0°C to +125°C	D ² PAK	50 Units /Rail
MC7805ACD2TG			D ² PAK (Pb-free)	50 Units /Rail
MC7805ACD2TR4			D ² PAK	800 / Tape & Reel
MC7805ACD2TR4G			D ² PAK (Pb-free)	800 / Tape & Reel
MC7805ACT			TO 220	50 Units /Rail
MC7805ACTG			TO 220 (Pb-free)	50 Units /Rail
MC7805BD2T		T = -40°C to +125°C	D ² PAK	50 Units /Rail
MC7805BD2TG			D ² PAK (Pb-free)	50 Units /Rail
MC7805BD2TR4			D ² PAK	800 / Tape & Reel
MC7805BD2TR4G			D ² PAK (Pb-free)	800 / Tape & Reel
MC7805BDT			DPAK	75 Units / Rail
MC7805BDTG			DPAK (Pb-free)	75 Units / Rail
MC7805BDTRK			DPAK	2500 / Tape & Reel
MC7805BDTRKG			DPAK (Pb-free)	2500 / Tape & Reel

[†]For information on tape and reel specifications, including part orientation and tape sizes, please refer to our Tape and Reel Packaging Specifications Brochure, BRD8011/D.

*NCV devices: T_{low} = -40°C, T_{high} = +125°C. Guaranteed by design. NCV prefix is for automotive and other applications requiring site and change control.

MC7800, MC7800A, NCV7805

ORDERING INFORMATION

Device	Nominal Voltage	Operating Temperature Range	Package	Shipping [†]
MC7805BT	5.0 V	T = -40°C to +125°C	TO 220	50 Units /Rail
MC7805BTG			TO 220 (Pb-free)	50 Units /Rail
NCV7805BD2T*			D ² PAK	50 Units /Rail
NCV7805BD2TG*			D ² PAK (Pb-free)	50 Units /Rail
NCV7805BD2TR4*			D ² PAK	800 / Tape & Reel
NCV7805BD2TR4G*			D ² PAK (Pb-free)	800 / Tape & Reel
NCV7805BT*			TO 220	50 Units /Rail
NCV7805BTG*			TO 220 (Pb-free)	50 Units /Rail
MC7805CD2T		T = 0°C to +125°C	D ² PAK	50 Units /Rail
MC7805CD2TG			D ² PAK (Pb-free)	50 Units /Rail
MC7805CD2TR4			D ² PAK	800 / Tape & Reel
MC7805CD2TR4G			D ² PAK (Pb-free)	800 / Tape & Reel
MC7805CDT			DPAK	75 Units / Rail
MC7805CDTG			DPAK (Pb-free)	75 Units / Rail
MC7805CDTRK			DPAK	2500 / Tape & Reel
MC7805CDTRKG			DPAK (Pb-free)	2500 / Tape & Reel
MC7805CT	TO 220		50 Units /Rail	
MC7805CTG	TO 220 (Pb-free)		50 Units /Rail	
MC7806ACT	6.0 V	T = 0°C to +125°C	TO 220	50 Units /Rail
MC7806ACTG			TO 220 (Pb-free)	50 Units /Rail
MC7806BD2T		T = -40°C to +125°C	D ² PAK	50 Units /Rail
MC7806BD2TG			D ² PAK (Pb-free)	50 Units /Rail
MC7806BD2TR4			D ² PAK	800 / Tape & Reel
MC7806BD2TR4G			D ² PAK (Pb-free)	800 / Tape & Reel
MC7806BT			TO 220	50 Units /Rail
MC7806BTG			TO 220 (Pb-free)	50 Units /Rail
MC7806CT		T = 0°C to +125°C	TO 220	50 Units /Rail
MC7806CTG			TO 220 (Pb-free)	50 Units /Rail

[†]For information on tape and reel specifications, including part orientation and tape sizes, please refer to our Tape and Reel Packaging Specifications Brochure, BRD8011/D.

*NCV devices: T_{low} = -40°C, T_{high} = +125°C. Guaranteed by design. NCV prefix is for automotive and other applications requiring site and change control.

MC7800, MC7800A, NCV7805

ORDERING INFORMATION

Device	Nominal Voltage	Operating Temperature Range	Package	Shipping [†]	
MC7808ABD2T	8.0 V	T = -40°C to +125°C	D ² PAK	50 Units /Rail	
MC7808ABD2TG			D ² PAK (Pb-free)	50 Units /Rail	
MC7808ABD2TR4			D ² PAK	800 / Tape & Reel	
MC7808ABD2TR4G			D ² PAK (Pb-free)	800 / Tape & Reel	
MC7808ABT			TO 220	50 Units /Rail	
MC7808ABTG			TO 220 (Pb-free)	50 Units /Rail	
MC7808ACT		T = 0°C to +125°C	TO 220	50 Units /Rail	
MC7808ACTG			TO 220 (Pb-free)	50 Units /Rail	
MC7808BD2T		T = -40°C to +125°C	D ² PAK	50 Units /Rail	
MC7808BD2TG			D ² PAK (Pb-free)	50 Units /Rail	
MC7808BD2TR4			D ² PAK	800 / Tape & Reel	
MC7808BD2TR4G			D ² PAK (Pb-free)	800 / Tape & Reel	
MC7808BDT			DPAK	75 Units / Rail	
MC7808BDTG			DPAK (Pb-free)	75 Units / Rail	
MC7808BDTRK			DPAK	2500 / Tape & Reel	
MC7808BDTRKG			DPAK (Pb-free)	2500 / Tape & Reel	
MC7808BT			TO 220	50 Units /Rail	
MC7808BTG			TO 220 (Pb-free)	50 Units /Rail	
MC7808CD2T			T = 0°C to +125°C	D ² PAK	50 Units /Rail
MC7808CD2TG				D ² PAK (Pb-free)	50 Units /Rail
MC7808CD2TR4				D ² PAK	800 / Tape & Reel
MC7808CD2TR4G				D ² PAK (Pb-free)	800 / Tape & Reel
MC7808CDT				DPAK	75 Units / Rail
MC7808CDTG				DPAK (Pb-free)	75 Units / Rail
MC7808CDTRK				DPAK	2500 / Tape & Reel
MC7808CDTRKG				DPAK (Pb-free)	2500 / Tape & Reel
MC7808CT		TO 220		50 Units /Rail	
MC7808CTG		TO 220 (Pb-free)		50 Units /Rail	

[†]For information on tape and reel specifications, including part orientation and tape sizes, please refer to our Tape and Reel Packaging Specifications Brochure, BRD8011/D.

*NCV devices: T_{low} = -40°C, T_{high} = +125°C. Guaranteed by design. NCV prefix is for automotive and other applications requiring site and change control.

MC7800, MC7800A, NCV7805

ORDERING INFORMATION

Device	Nominal Voltage	Operating Temperature Range	Package	Shipping [†]	
MC7809ACT	9.0 V	T = 0°C to +125°C	TO 220	50 Units /Rail	
MC7809ACTG			TO 220 (Pb-free)	50 Units /Rail	
MC7809BT		T = -40°C to +125°C	TO 220	50 Units /Rail	
MC7809BTG			TO 220 (Pb-free)	50 Units /Rail	
MC7809CD2T		T = 0°C to +125°C	D ² PAK	50 Units /Rail	
MC7809CD2TG			D ² PAK (Pb-free)	50 Units /Rail	
MC7809CD2TR4			D ² PAK	800 / Tape & Reel	
MC7809CD2TR4G			D ² PAK (Pb-free)	800 / Tape & Reel	
MC7809CT			TO 220	50 Units /Rail	
MC7809CTG			TO 220 (Pb-free)	50 Units /Rail	
MC7812ABD2T			12 V	T = -40°C to +125°C	D ² PAK
MC7812ABD2TG	D ² PAK (Pb-free)				50 Units /Rail
MC7812ABD2TR4	D ² PAK	800 / Tape & Reel			
MC7812ABD2TR4G	D ² PAK (Pb-free)	800 / Tape & Reel			
MC7812ABT	TO 220	50 Units /Rail			
MC7812ABTG	TO 220 (Pb-free)	50 Units /Rail			
MC7812ACD2T	T = 0°C to +125°C	D ² PAK		50 Units /Rail	
MC7812ACD2TG		D ² PAK (Pb-free)		50 Units /Rail	
MC7812ACD2TR4		D ² PAK		800 / Tape & Reel	
MC7812ACD2TR4G		D ² PAK (Pb-free)		800 / Tape & Reel	
MC7812ACT		TO 220		50 Units /Rail	
MC7812ACTG		TO 220 (Pb-free)		50 Units /Rail	
MC7812BD2T	T = -40°C to +125°C	D ² PAK		50 Units /Rail	
MC7812BD2TG		D ² PAK (Pb-free)		50 Units /Rail	
MC7812BD2TR4		D ² PAK		800 / Tape & Reel	
MC7812BD2TR4G		D ² PAK (Pb-free)		800 / Tape & Reel	
MC7812BDT		DPAK		75 Units / Rail	
MC7812BDTG		DPAK (Pb-free)		75 Units / Rail	

[†]For information on tape and reel specifications, including part orientation and tape sizes, please refer to our Tape and Reel Packaging Specifications Brochure, BRD8011/D.

*NCV devices: T_{low} = -40°C, T_{high} = +125°C. Guaranteed by design. NCV prefix is for automotive and other applications requiring site and change control.

MC7800, MC7800A, NCV7805

ORDERING INFORMATION

Device	Nominal Voltage	Operating Temperature Range	Package	Shipping [†]
MC7812BDTRK	12 V	T = -40°C to +125°C	DPAK	2500 / Tape & Reel
MC7812BDTRKG			DPAK (Pb-free)	2500 / Tape & Reel
MC7812BT			TO 220	50 Units /Rail
MC7812BTG			TO 220 (Pb-free)	50 Units /Rail
NCV7812BD2T *			D ² PAK	50 Units /Rail
NCV7812BD2TR4 *			D ² PAK	800 / Tape & Reel
NCV7812BD2TR4G *			D ² PAK (Pb-free)	800 / Tape & Reel
NCV7812BT *			TO 220	50 Units /Rail
NCV7812BTG *			TO 220 (Pb-free)	50 Units /Rail
MC7812CD2T			12 V	T = 0°C to +125°C
MC7812CD2TG	D ² PAK (Pb-free)	50 Units /Rail		
MC7812CD2TR4	D ² PAK	800 / Tape & Reel		
MC7812CD2TR4G	D ² PAK (Pb-free)	800 / Tape & Reel		
MC7812CDT	DPAK	75 Units / Rail		
MC7812CDTG	DPAK (Pb-free)	75 Units / Rail		
MC7812CDTRK	DPAK	2500 / Tape & Reel		
MC7812CDTRKG	DPAK (Pb-free)	2500 / Tape & Reel		
MC7812CT	TO 220	50 Units /Rail		
MC7812CTG	TO 220 (Pb-free)	50 Units /Rail		

†For information on tape and reel specifications, including part orientation and tape sizes, please refer to our Tape and Reel Packaging Specifications Brochure, BRD8011/D.

*NCV devices: T_{low} = -40°C, T_{high} = +125°C. Guaranteed by design. NCV prefix is for automotive and other applications requiring site and change control.

MC7800, MC7800A, NCV7805

ORDERING INFORMATION

Device	Nominal Voltage	Operating Temperature Range	Package	Shipping [†]
MC7815ABD2T	15 V	T = -40°C to +125°C	D ² PAK	50 Units /Rail
MC7815ABD2TG			D ² PAK (Pb-free)	50 Units /Rail
MC7815ABD2TR4			D ² PAK	800 / Tape & Reel
MC7815ABD2TR4G			D ² PAK (Pb-free)	800 / Tape & Reel
MC7815ABT			TO 220	50 Units /Rail
MC7815ABTG			TO 220 (Pb-free)	50 Units /Rail
MC7815ACD2T		T = 0°C to +125°C	D ² PAK	50 Units /Rail
MC7815ACD2TG			D ² PAK (Pb-free)	50 Units /Rail
MC7815ACT			TO 220	50 Units /Rail
MC7815ACTG			TO 220 (Pb-free)	50 Units /Rail
MC7815BD2T		T = -40°C to +125°C	D ² PAK	50 Units /Rail
MC7815BD2TG			D ² PAK (Pb-free)	50 Units /Rail

†For information on tape and reel specifications, including part orientation and tape sizes, please refer to our Tape and Reel Packaging Specifications Brochure, BRD8011/D.

*NCV devices: T_{low} = -40°C, T_{high} = +125°C. Guaranteed by design. NCV prefix is for automotive and other applications requiring site and change control.

MC7800, MC7800A, NCV7805

ORDERING INFORMATION

Device	Nominal Voltage	Operating Temperature Range	Package	Shipping [†]	
MC7815BD2TR4	15 V	T = -40°C to +125°C	D ² PAK	800 / Tape & Reel	
MC7815BD2TR4G			D ² PAK (Pb-free)	800 / Tape & Reel	
MC7815BDT			DPAK	75 Units / Rail	
MC7815BDTG			DPAK (Pb-free)	75 Units / Rail	
MC7815BDTRK			DPAK	2500 / Tape & Reel	
MC7815BDTRKG			DPAK (Pb-free)	2500 / Tape & Reel	
MC7815BT			TO 220	50 Units /Rail	
MC7815BTG			TO 220 (Pb-free)	50 Units /Rail	
MC7815CD2T			T = 0°C to +125°C	D ² PAK	50 Units /Rail
MC7815CD2TG		D ² PAK (Pb-free)		50 Units /Rail	
MC7815CD2TR4		D ² PAK		800 / Tape & Reel	
MC7815CD2TR4G		D ² PAK (Pb-free)		800 / Tape & Reel	
MC7815CDT		DPAK		75 Units / Rail	
MC7815CDTG		DPAK (Pb-free)		75 Units / Rail	
MC7815CDTRK		DPAK		2500 / Tape & Reel	
MC7815CDTRKG		DPAK (Pb-free)		2500 / Tape & Reel	
MC7815CT		TO 220		50 Units /Rail	
MC7815CTG		TO 220 (Pb-free)		50 Units /Rail	
MC7818ACT	18 V	T = 0°C to +125°C		TO 220	50 Units /Rail
MC7818ACTG				TO 220 (Pb-free)	50 Units /Rail
MC7818BT		T = -40°C to +125°C	TO 220	50 Units /Rail	
MC7818BTG			TO 220 (Pb-free)	50 Units /Rail	
MC7818CD2T		T = 0°C to +125°C	D ² PAK	50 Units /Rail	
MC7818CD2TR4			D ² PAK	800 / Tape & Reel	
MC7818CD2TR4G			D ² PAK (Pb-free)	800 / Tape & Reel	
MC7818CT			TO 220	50 Units /Rail	
MC7818CTG			TO 220 (Pb-free)	50 Units /Rail	

[†]For information on tape and reel specifications, including part orientation and tape sizes, please refer to our Tape and Reel Packaging Specifications Brochure, BRD8011/D.

*NCV devices: T_{low} = -40°C, T_{high} = +125°C. Guaranteed by design. NCV prefix is for automotive and other applications requiring site and change control.

MC7800, MC7800A, NCV7805

ORDERING INFORMATION

Device	Nominal Voltage	Operating Temperature Range	Package	Shipping [†]
MC7824ACT	24 V	T = 0°C to +125°C	TO 220	50 Units /Rail
MC7824ACTG			TO 220 (Pb-free)	50 Units /Rail
MC7824BD2T		T = -40°C to +125°C	D ² PAK	50 Units /Rail
MC7824BD2TG			D ² PAK (Pb-free)	50 Units /Rail
MC7824BD2TR4			D ² PAK	800 / Tape & Reel
MC7824BD2TR4G			D ² PAK (Pb-free)	800 / Tape & Reel
MC7824BT			TO 220	50 Units /Rail
MC7824BTG			TO 220 (Pb-free)	50 Units /Rail
MC7824CD2T		T = 0°C to +125°C	D ² PAK	50 Units /Rail
MC7824CD2TG			D ² PAK (Pb-free)	50 Units /Rail
MC7824CD2TR4			D ² PAK	800 / Tape & Reel
MC7824CD2TR4G			D ² PAK (Pb-free)	800 / Tape & Reel
MC7824CT			TO 220	50 Units /Rail
MC7824CTG			TO 220 (Pb-free)	50 Units /Rail

[†]For information on tape and reel specifications, including part orientation and tape sizes, please refer to our Tape and Reel Packaging Specifications Brochure, BRD8011/D.

*NCV devices: T_{low} = -40°C, T_{high} = +125°C. Guaranteed by design. NCV prefix is for automotive and other applications requiring site and change control.

MARKING DIAGRAMS



**TO-220-3
T SUFFIX
CASE 221A**

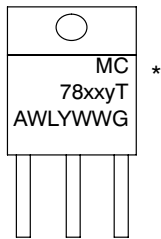

**D²PAK-3
D2T SUFFIX
CASE 936**

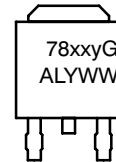
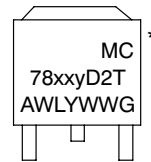

**DPAK-3
DT SUFFIX
CASE 369C**

*This marking diagram also applies to NCV78xx family.

xx = 05, 06, 08, 09, 12, 15, 18, or 24
y = B or C
A = Assembly Location
WL, L = Wafer Lot
Y = Year
WW = Work Week
G = Pb-Free Device

MC7800, MC7800A, NCV7805

PACKAGE DIMENSIONS

TO-220, SINGLE GAUGE
T SUFFIX
CASE 221AB-01
ISSUE O

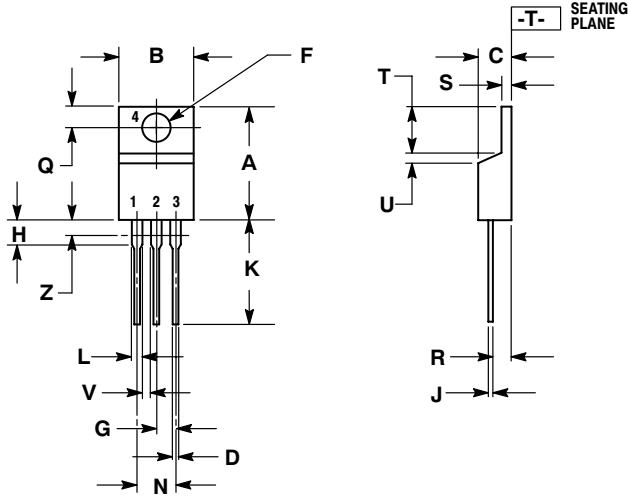

- NOTES:
1. DIMENSIONING AND TOLERANCING PER ANSI Y14.5M, 1982.
 2. CONTROLLING DIMENSION: INCH.
 3. DIMENSION Z DEFINES A ZONE WHERE ALL BODY AND LEAD IRREGULARITIES ARE ALLOWED.

DIM	INCHES		MILLIMETERS	
	MIN	MAX	MIN	MAX
A	0.570	0.620	14.48	15.75
B	0.380	0.405	9.66	10.28
C	0.160	0.190	4.07	4.82
D	0.025	0.035	0.64	0.88
F	0.142	0.147	3.61	3.73
G	0.095	0.105	2.42	2.66
H	0.110	0.155	2.80	3.93
J	0.018	0.025	0.46	0.64
K	0.500	0.562	12.70	14.27
L	0.045	0.060	1.15	1.52
N	0.190	0.210	4.83	5.33
Q	0.100	0.120	2.54	3.04
R	0.080	0.110	2.04	2.79
S	0.020	0.055	0.508	1.39
T	0.235	0.255	5.97	6.47
U	0.000	0.050	0.00	1.27
V	0.045	---	1.15	---
Z	---	0.080	---	2.04

MC7800, MC7800A, NCV7805

PACKAGE DIMENSIONS

D²PAK-3
D2T SUFFIX
 CASE 936-03
 ISSUE B

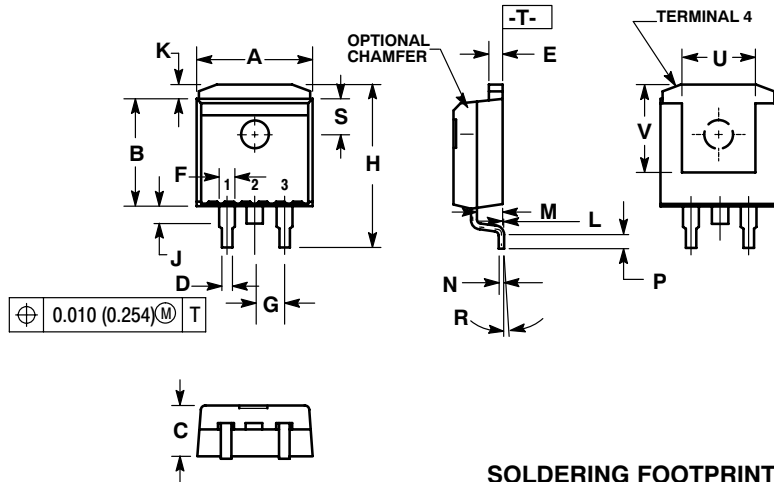

NOTES:

1. DIMENSIONING AND TOLERANCING PER ANSI Y14.5M, 1982.
2. CONTROLLING DIMENSION: INCH.
3. TAB CONTOUR OPTIONAL WITHIN DIMENSIONS A AND K.
4. DIMENSIONS U AND V ESTABLISH A MINIMUM MOUNTING SURFACE FOR TERMINAL 4.
5. DIMENSIONS A AND B DO NOT INCLUDE MOLD FLASH OR GATE PROTRUSIONS. MOLD FLASH AND GATE PROTRUSIONS NOT TO EXCEED 0.025 (0.635) MAXIMUM.

DIM	INCHES		MILLIMETERS	
	MIN	MAX	MIN	MAX
A	0.386	0.403	9.804	10.236
B	0.356	0.368	9.042	9.347
C	0.170	0.180	4.318	4.572
D	0.026	0.036	0.660	0.914
E	0.045	0.055	1.143	1.397
F	0.051 REF		1.295 REF	
G	0.100 BSC		2.540 BSC	
H	0.539	0.579	13.691	14.707
J	0.125 MAX		3.175 MAX	
K	0.050 REF		1.270 REF	
L	0.000	0.010	0.000	0.254
M	0.088	0.102	2.235	2.591
N	0.018	0.026	0.457	0.660
P	0.058	0.078	1.473	1.981
R	5° REF		5° REF	
S	0.116 REF		2.946 REF	
U	0.200 MIN		5.080 MIN	
V	0.250 MIN		6.350 MIN	

SOLDERING FOOTPRINT*

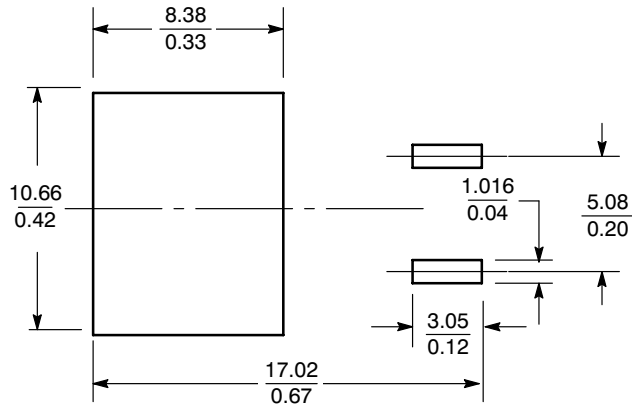

D²PAK-3

SCALE 3:1 (mm/inches)

*For additional information on our Pb-Free strategy and soldering details, please download the ON Semiconductor Soldering and Mounting Techniques Reference Manual, SOLDERRM/D.

MC7800, MC7800A, NCV7805

PACKAGE DIMENSIONS

DPAK-3
DT SUFFIX
CASE 369C-01
ISSUE 0

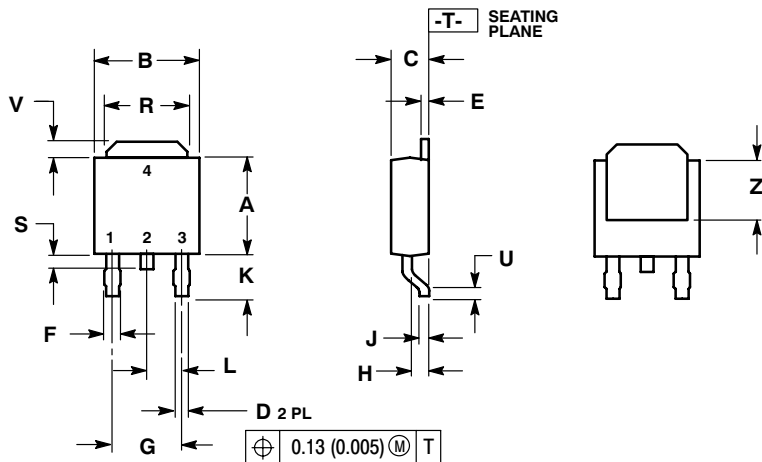

- NOTES:
1. DIMENSIONING AND TOLERANCING PER ANSI Y14.5M, 1982.
2. CONTROLLING DIMENSION: INCH.

DIM	INCHES		MILLIMETERS	
	MIN	MAX	MIN	MAX
A	0.235	0.245	5.97	6.22
B	0.250	0.265	6.35	6.73
C	0.086	0.094	2.19	2.38
D	0.027	0.035	0.69	0.88
E	0.018	0.023	0.46	0.58
F	0.037	0.045	0.94	1.14
G	0.180 BSC		4.58 BSC	
H	0.034	0.040	0.87	1.01
J	0.018	0.023	0.46	0.58
K	0.102	0.114	2.60	2.89
L	0.090 BSC		2.29 BSC	
R	0.180	0.215	4.57	5.45
S	0.025	0.040	0.63	1.01
U	0.020	---	0.51	---
V	0.035	0.050	0.89	1.27
Z	0.155	---	3.93	---

SOLDERING FOOTPRINT*

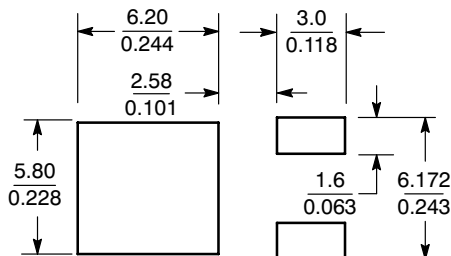

SCALE 3:1 $\left(\frac{\text{mm}}{\text{inches}}\right)$

*For additional information on our Pb-Free strategy and soldering details, please download the ON Semiconductor Soldering and Mounting Techniques Reference Manual, SOLDERRM/D.

ON Semiconductor and are registered trademarks of Semiconductor Components Industries, LLC (SCILLC). SCILLC reserves the right to make changes without further notice to any products herein. SCILLC makes no warranty, representation or guarantee regarding the suitability of its products for any particular purpose, nor does SCILLC assume any liability arising out of the application or use of any product or circuit, and specifically disclaims any and all liability, including without limitation special, consequential or incidental damages. "Typical" parameters which may be provided in SCILLC data sheets and/or specifications can and do vary in different applications and actual performance may vary over time. All operating parameters, including "Typicals" must be validated for each customer application by customer's technical experts. SCILLC does not convey any license under its patent rights nor the rights of others. SCILLC products are not designed, intended, or authorized for use as components in systems intended for surgical implant into the body, or other applications intended to support or sustain life, or for any other application in which the failure of the SCILLC product could create a situation where personal injury or death may occur. Should Buyer purchase or use SCILLC products for any such unintended or unauthorized application, Buyer shall indemnify and hold SCILLC and its officers, employees, subsidiaries, affiliates, and distributors harmless against all claims, costs, damages, and expenses, and reasonable attorney fees arising out of, directly or indirectly, any claim of personal injury or death associated with such unintended or unauthorized use, even if such claim alleges that SCILLC was negligent regarding the design or manufacture of the part. SCILLC is an Equal Opportunity/Affirmative Action Employer. This literature is subject to all applicable copyright laws and is not for resale in any manner.

PUBLICATION ORDERING INFORMATION

LITERATURE FULFILLMENT:
Literature Distribution Center for ON Semiconductor
P.O. Box 5163, Denver, Colorado 80217 USA
Phone: 303-675-2175 or 800-344-3860 Toll Free USA/Canada
Fax: 303-675-2176 or 800-344-3867 Toll Free USA/Canada
Email: orderlit@onsemi.com

N. American Technical Support: 800-282-9855 Toll Free
USA/Canada
Europe, Middle East and Africa Technical Support:
Phone: 421 33 790 2910
Japan Customer Focus Center
Phone: 81-3-5773-3850

ON Semiconductor Website: www.onsemi.com
Order Literature: <http://www.onsemi.com/orderlit>

For additional information, please contact your local Sales Representative