

JAN 16 1991

MOTOROLA SEMICONDUCTOR TECHNICAL DATA

Low Voltage Compander

The MC33110 contains two variable gain circuits configured for compressing and expanding the dynamic range of an audio signal. One circuit is configured as an expander, while the other circuit can be configured as a compressor or expander. Each circuit has a full wave rectifier to provide average value information to a variable gain cell located in either the input stage or the feedback path. An internal, temperature stable bandgap reference provides the necessary precision voltages and currents required.

The MC33110 will operate from a supply voltage of 2.1 to 7.0 V, over a temperature range of -40° to $+85^{\circ}\text{C}$. The device is designed to accommodate an 80 dB dynamic range from -60 dB to $+20$ dB, referenced to 100 mVrms.

Applications include cordless telephone, CB, walkie-talkie, most voice RF links, and any application where the signal-to-noise ratio can be improved by reducing the transmitted dynamic range. Other applications include speakerphone and voice activated intercom, dictating machine, standard telephone, etc.

The MC33110 is packaged in a 14 pin DIP for through-the-hole applications and an SO-14 surface mount.

- Operating Supply Voltage: 2.1 to 7.0 V
- No Precision External Components Required
- 80 dB Dynamic Range Compressed to 40 dB, Re-expandable to 80 dB
- Unity Gain Level: 100 mVrms
- Adjustable Response Time
- Ambient Operating Temperature: -40° to $+85^{\circ}\text{C}$
- Temperature Compensated Reference
- Applications Include Cordless Phone, CB Radio, Speakerphone, etc.

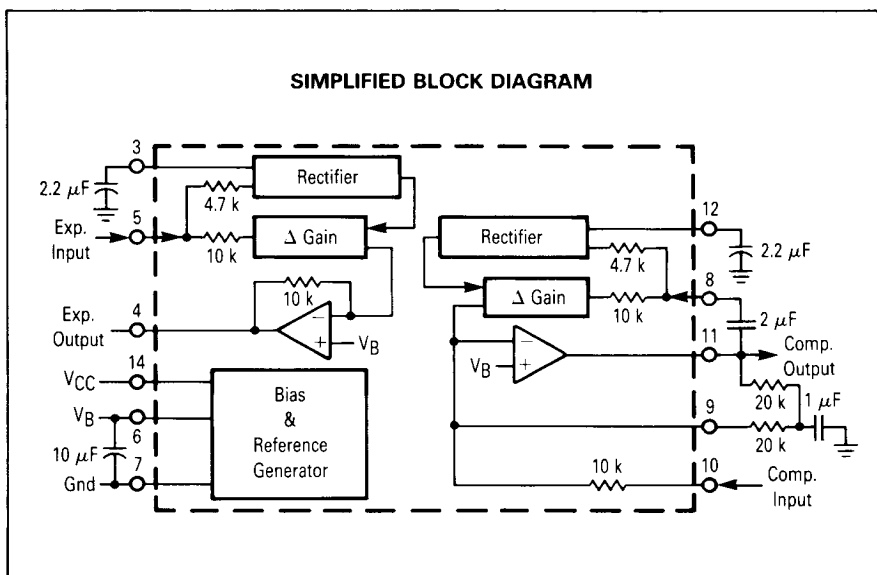

MC33110

LOW VOLTAGE COMPANDER

**SILICON MONOLITHIC
INTEGRATED CIRCUIT**

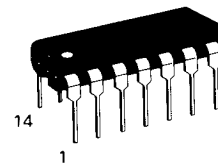

**P SUFFIX
PLASTIC PACKAGE
CASE 646**

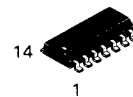

**D SUFFIX
PLASTIC PACKAGE
CASE 751A
(SO-14)**

PIN CONNECTIONS (TOP VIEW)

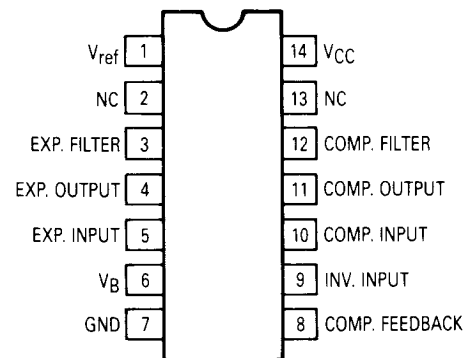

ORDERING INFORMATION

| Device | Temperature Range | Package |
|----------|--|-------------|
| MC33110D | -40°C to $+85^{\circ}\text{C}$ | SO-14 |
| MC33110P | | Plastic DIP |

©MOTOROLA INC., 1990

DS9762

PIN DESCRIPTION

| Name | Pin | Description |
|---------------------|-------|--|
| V _{ref} | 1 | Normally this pin is not used and is left open. It can be used to make limited adjustments to the 0 dB level. Any noise or leakage at this pin will affect the 0 dB level and gain tracking. |
| NC | 2, 13 | No connection. These pins are not internally connected. |
| Expander Filter | 3 | Connect to an external capacitor to filter the full wave rectifier's output. This capacitor affects attack and decay times, as well as low frequency accuracy. |
| Expander Output | 4 | Output of the expander amplifier. |
| Expander Input | 5 | The input impedance is nominally 3.2 kΩ. Nominal signal range is 3.16 mVrms to 316 mVrms. Must be capacitor coupled to the signal source. |
| V _B | 6 | An internal reference voltage, nominally V _{CC} /2. This is an AC ground and must be well filtered to obtain high power supply rejection and low crosstalk. |
| Ground | 7 | Connect to a clean power supply ground. |
| Compressor Feedback | 8 | Input to the compressor variable gain stage and rectifier. Normally the signal is supplied by the compressor's output (Pin 11). Input impedance is nominally 3.2 kΩ. |
| Inverting Input | 9 | Inverting input to the compressor amplifier. Normally, this is connected to the compressor's output through a filtered DC feedback path. |
| Compressor Input | 10 | The input impedance is nominally 10 kΩ. Nominal signal range is 100 μVrms to 1.0 Vrms. Must be capacitor coupled to the signal source. |
| Compressor Output | 11 | Output of the compressor amplifier. |
| Compressor Filter | 12 | Connect to an external capacitor to filter the full wave rectifier's output. This capacitor affects attack & decay times, and low frequency accuracy. |
| V _{CC} | 14 | Power supply pin. Connect to a power supply providing between 2.1 V and 7.0 V. Nominal current consumption is 3.5 mA. |

COMPRESSOR

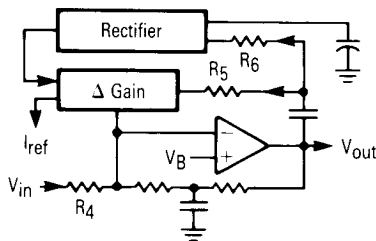

$$V_{out} = \sqrt{\frac{R_5 \times R_6 \times I_{ref} \times V_{in}}{7.2 \times R_4}}$$

$$= 0.3162 \times \sqrt{V_{in}}$$

TRANSFER FUNCTIONS

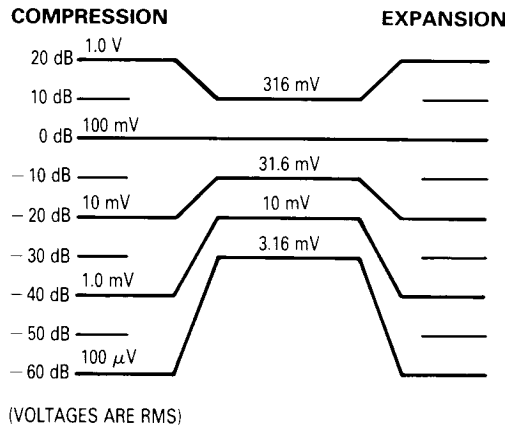

EXPANDER

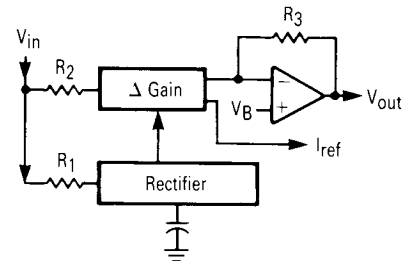

$$V_{out} = \frac{7.2 \times R_3 \times V_{in}^2}{R_1 \times R_2 \times I_{ref}}$$

$$= 10 \times V_{in}^2$$

ABSOLUTE MAXIMUM RATINGS

| Rating | Symbol | Value | Unit |
|------------------------------------|-----------------|-----------------------|------|
| V _{CC} Supply Voltage | V _{CC} | +12, -0.5 | Vdc |
| High Input Voltage (Pin 5 & 10) | V _{IH} | V _{CC} + 0.5 | Vdc |
| Low Input Voltage | V _{IL} | -0.5 | Vdc |
| Output Source Current (Pin 4 & 11) | I _{O+} | Self-Limiting | |
| Output Sink Current | I _{O-} | 20 | mA |
| Junction Temperature | T _J | -65, +150 | °C |

Devices should not be operated at these values. The "Recommended Operating Conditions" table provides conditions for actual device operation.

RECOMMENDED OPERATING CONDITIONS

| Characteristic | Symbol | Min | Typ | Max | Unit |
|--|-----------------|-------------|-------------|----------------------|------|
| V _{CC} Supply Voltage | V _{CC} | 2.1 | — | 7.0 | Vdc |
| Input Voltage Range Compressor, 2.1 V < V _{CC} < 7.0 V Expander, V _{CC} = 2.1 V Expander, 3.0 V < V _{CC} < 7.0 V | V _{IR} | 0 0 0 | — — — | 1.0 0.25 0.316 | Vrms |
| Input Frequency | F _{in} | 100 | — | 20 k | Hz |
| Output Load Compressor (Pin 11, V _O = 100 mV) Expander (Pin 4, V _O = 100 mV) | R _L | 300 150 | — — | ∞ ∞ | Ω |
| Ambient Temperature | T _A | -40 | — | +85 | °C |

All limits are not necessarily functional concurrently.

ELECTRICAL CHARACTERISTICS (V_{CC} = 5.0 V, f = 1.0 kHz, unless otherwise noted, T_A = 25°C, see Figure 1)

| Characteristic | Symbol | Min | Typ | Max | Unit |
|----------------|--------|-----|-----|-----|------|
|----------------|--------|-----|-----|-----|------|

POWER SUPPLY

| | | | | | |
|---|-----------------|----------|---------------------------|----------|-----|
| Power Supply Current V _{CC} = +5.0 V V _{CC} = +2.1 V | I _{CC} | — — | 3.5 3.3 | 5.5 — | mA |
| V _B Voltage V _{CC} = +5.0 V 2.1 V < V _{CC} < 7.0 V | V _B | 2.4 — | 2.5 V _{CC} /2 | 2.6 — | Vdc |

COMPRESSOR

| | | | | | |
|---|--------------------|-----------------------|--------------------------|----------------------|------|
| 0 dB Gain V _{in} = 100 mVrms, Pin 1 = Open | G(CO) | -1.5 | 0 | 1.5 | dB |
| Gain Tracking @ V _{in} = 1.0 Vrms, output relative to G(CO) @ V _{in} = 10 mVrms, output relative to G(CO) @ V _{in} = 1.0 mVrms, output relative to G(CO) @ V _{in} = 100 μVrms, output relative to G(CO) | G _t | +9.0 — — -31 | +10 -10 -20 -30 | +11 — — -29 | dB |
| Total Harmonic Distortion V _{in} = 100 mVrms, f = 1.0 kHz | THD | 0 | 0.1 | 1.5 | % |
| Power Supply Rejection f = 1.0 kHz, C _{V_B} = 10 μF, V _{in} = -20 dB | PSRR | — | 22 | — | dB |
| Attack Time (Capacitor @ Pin 12 = 2.2 μF) | t _a (C) | — | 6.0 | — | ms |
| Decay Time (Capacitor @ Pin 12 = 2.2 μF) | t _d (C) | — | 20 | — | ms |
| Input Impedance | R _{in} | — | 10 3.2 | — | kΩ |
| Peak Output Current | I _{pk} | — | 0.3 | — | mA |
| Output Offset Pin 11, with respect to Pin 6, NO SIGNAL Change from NO SIGNAL to 1.0 Vrms at Input | V _{OO} | -150 — | 0 50 | +150 — | mVdc |

ELECTRICAL CHARACTERISTICS ($V_{CC} = 5.0\text{ V}$, $f = 1.0\text{ kHz}$, unless otherwise noted, $T_A = 25^\circ\text{C}$, see Figure 1)

| Characteristic | Symbol | Min | Typ | Max | Unit | |
|--|------------|----------------------|--------------------------|----------------------|------|-----------|
| EXPANDER | | | | | | |
| 0 dB Gain ($V_{in} = 100\text{ mVrms}$, Pin 1 = open) | $G_{(EO)}$ | -1.5 | 0 | 1.5 | dB | |
| Gain Tracking @ $V_{in} = 316\text{ mVrms}$, output relative to $G_{(EO)}$ @ $V_{in} = 31.6\text{ mVrms}$, output relative to $G_{(EO)}$ @ $V_{in} = 10\text{ mVrms}$, output relative to $G_{(EO)}$ @ $V_{in} = 3.16\text{ mVrms}$, output relative to $G_{(EO)}$ | G_t | +19 — — -61 | +20 -20 -40 -60 | +21 — — -59 | dB | |
| Total Harmonic Distortion $V_{in} = 100\text{ mVrms}$, $f = 1.0\text{ kHz}$ | THD | 0 | 0.06 | 1.5 | % | |
| Power Supply Rejection ($f = 1.0\text{ kHz}$, $C_{VB} = 10\ \mu\text{F}$) | PSRR | — | 37 | — | dB | |
| Attack Time (Capacitor @ Pin 3 = $2.2\ \mu\text{F}$) | $t_a(E)$ | — | 19 | — | ms | |
| Decay Time (Capacitor @ Pin 3 = $2.2\ \mu\text{F}$) | $t_d(E)$ | — | 20 | — | ms | |
| Input Impedance | Pin 5 | R_{in} | — | 3.2 | — | $k\Omega$ |
| Peak Output Current | Pin 4 | I_{pk} | — | 1.0 | — | mA |
| Output Offset Pin 4, with respect to Pin 6, NO SIGNAL Change from NO SIGNAL to 316 mVrms at Input | V_{OO} | -150 — | 0 25 | +150 — | mVdc | |
| MISCELLANEOUS | | | | | | |
| Gain (Pin 10 to Pin 4; Pin 11 capacitor coupled to Pin 5) $V_{CC} = 7.0\text{ V}$, $V_{in} = 1.0\text{ Vrms}$ $V_{CC} = 3.0\text{ V}$, $V_{in} = 1.0\text{ Vrms}$ $V_{CC} = 2.1\text{ V}$, $V_{in} = 31.6\text{ mVrms}$ | A_V | -2.5 -2.5 -2.5 | 0 0 0 | +2.5 +2.5 +2.5 | dB | |
| Channel Separation Expander to Compressor, output measured at Pin 11 V_{in} @ Pin 5 = 316 mVrms , $f = 1.0\text{ kHz}$ V_{in} @ Pin 5 = 316 mVrms , $f = 10\text{ kHz}$ | CS | 43 — | 48 68 | — — | dB | |
| Compressor to Expander, output measured at Pin 4 V_{in} @ Pin 10 = 1.0 Vrms , $f = 1.0\text{ kHz}$ V_{in} @ Pin 10 = 1.0 Vrms , $f = 10\text{ kHz}$ | | 65 — | 107 114 | — — | | |

FIGURE 1 — TEST CIRCUIT

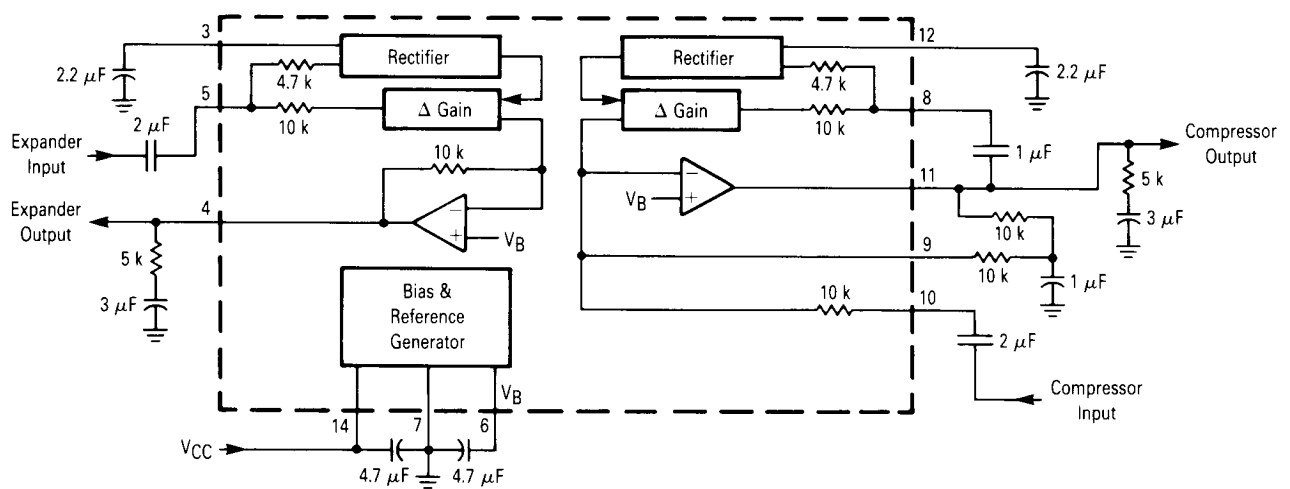

COMPRESSOR

FIGURE 2 — COMPRESSOR TRANSFER CHARACTERISTICS

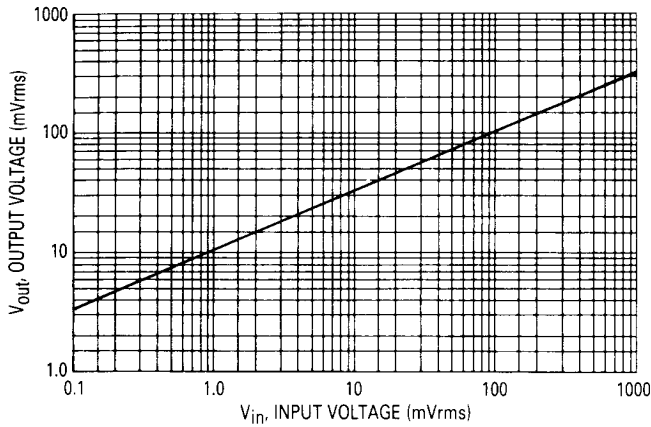

FIGURE 4 — COMPRESSOR TRANSFER CHARACTERISTICS

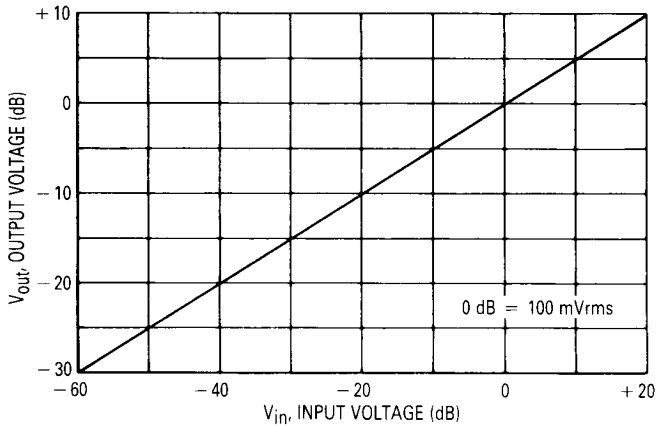
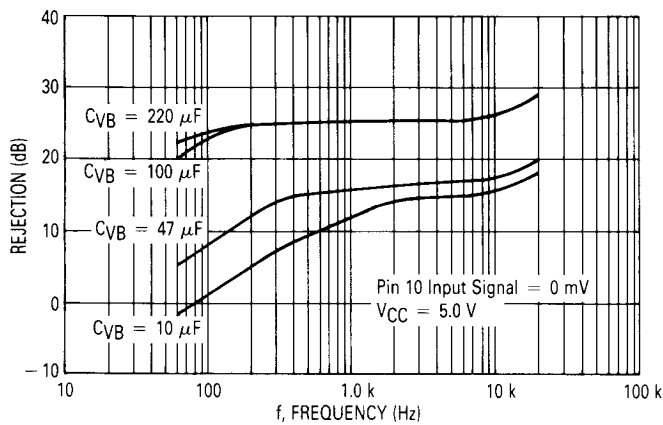

FIGURE 6 — POWER SUPPLY REJECTION (COMPRESSOR)



EXPANDER

FIGURE 3 — EXPANDER TRANSFER CHARACTERISTICS

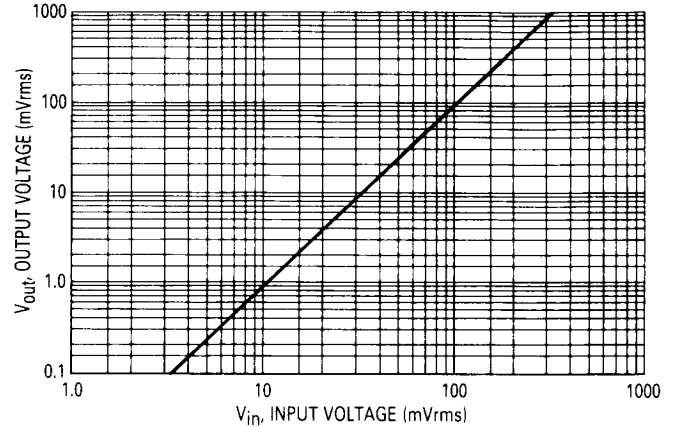

FIGURE 5 — EXPANDER TRANSFER CHARACTERISTICS

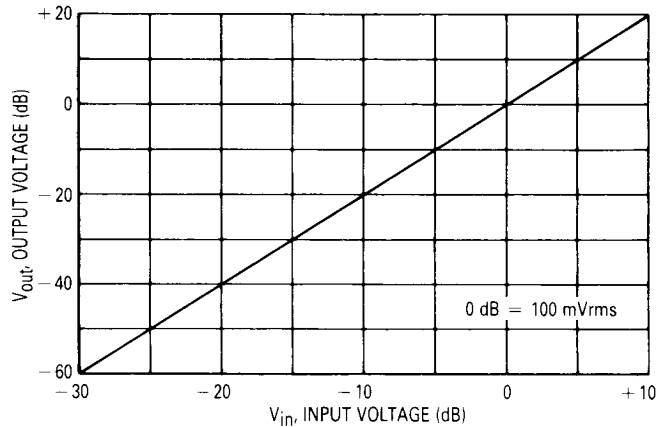
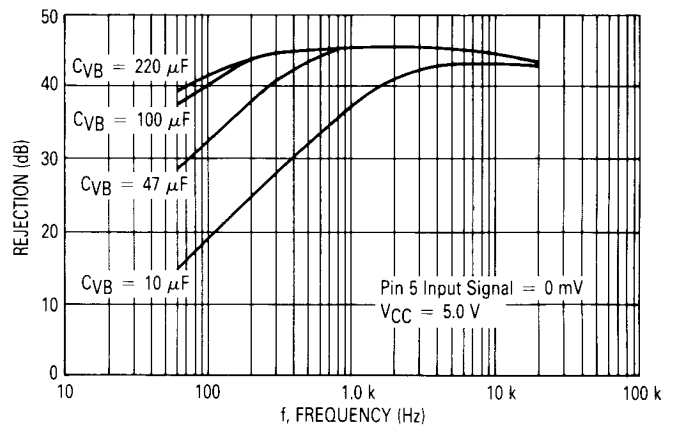

FIGURE 7 — POWER SUPPLY REJECTION (EXPANDER)



COMPRESSOR

FIGURE 8 — POWER SUPPLY REJECTION (COMPRESSOR)

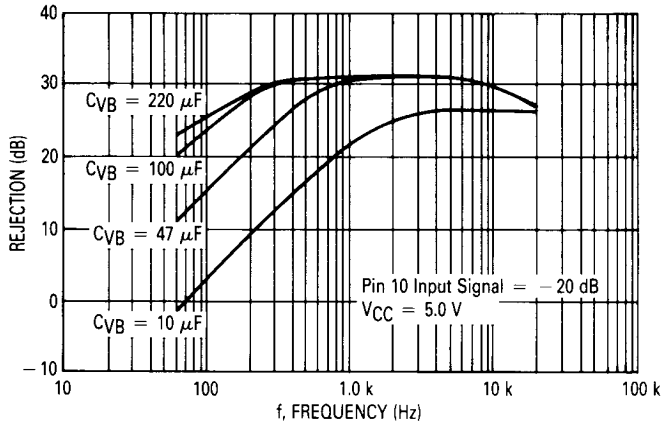

FIGURE 10 — FREQUENCY RESPONSE (COMPRESSOR)

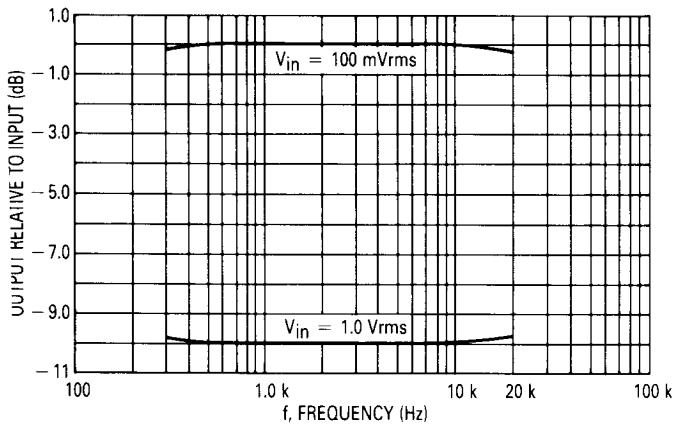
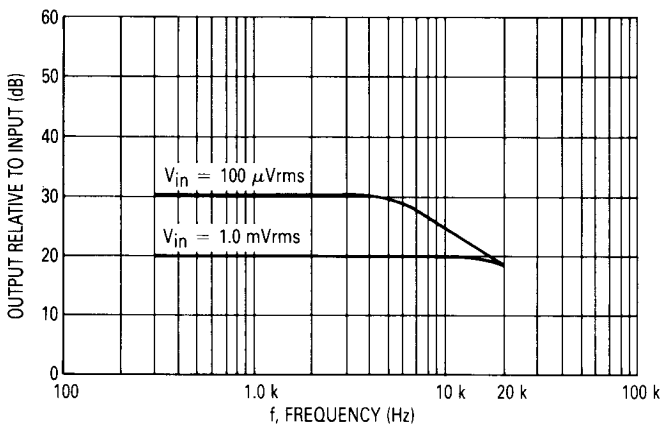

FIGURE 12 — FREQUENCY RESPONSE (COMPRESSOR)



EXPANDER

FIGURE 9 — POWER SUPPLY REJECTION (EXPANDER)

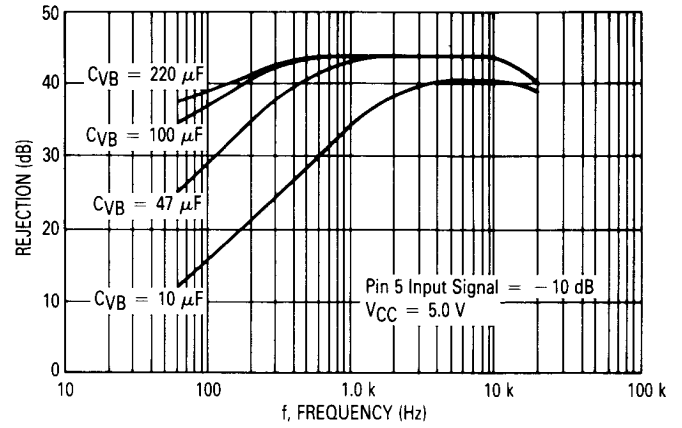

FIGURE 11 — FREQUENCY RESPONSE (EXPANDER)

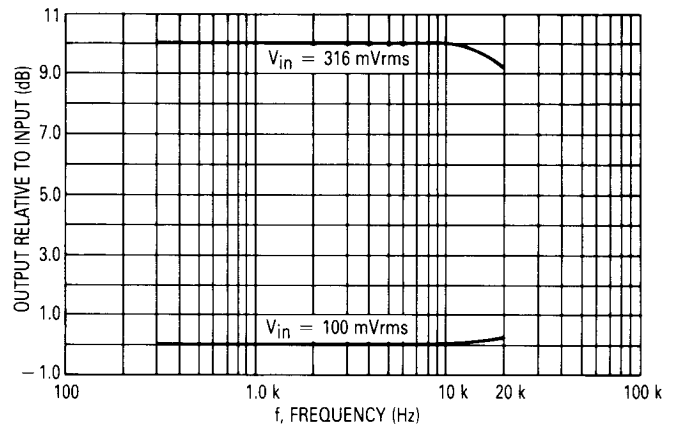

FIGURE 13 — FREQUENCY RESPONSE (EXPANDER)

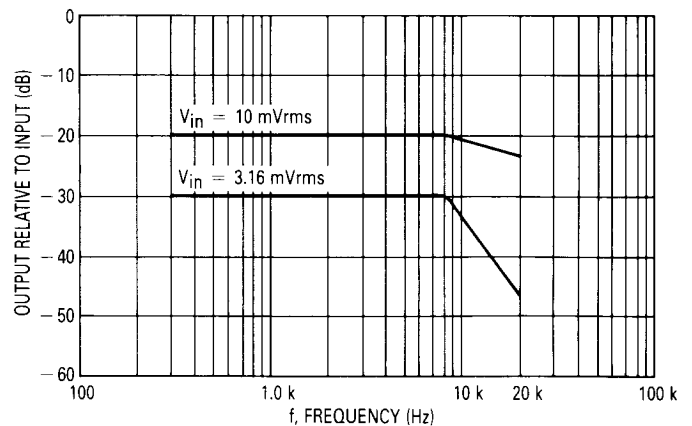

FIGURE 14 — ATTACK AND DECAY TIMES (COMPRESSOR)

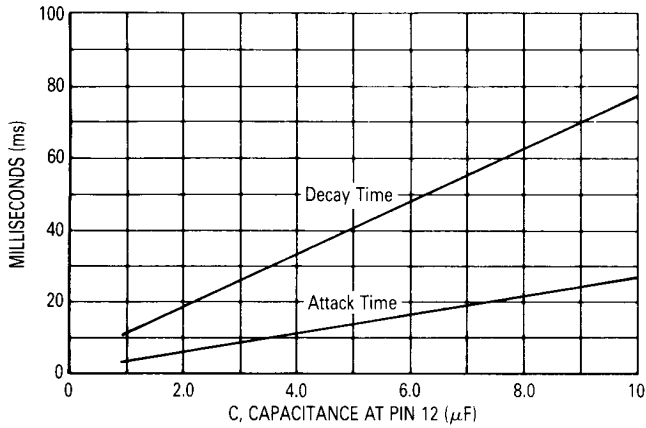

FIGURE 15 — ATTACK AND DECAY TIMES (EXPANDER)

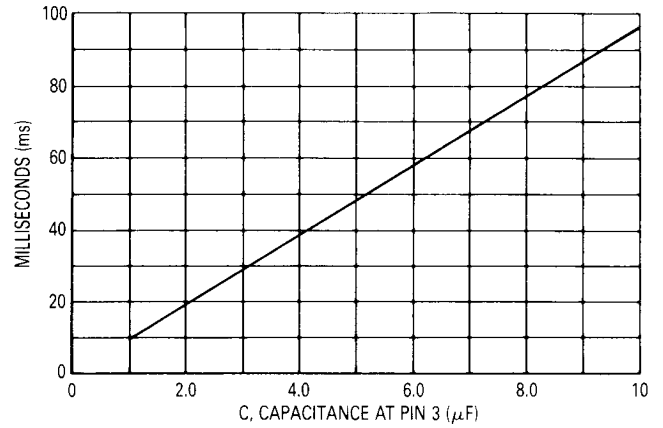

FIGURE 16 — ATTACK AND DECAY TIMES (COMPRESSOR)

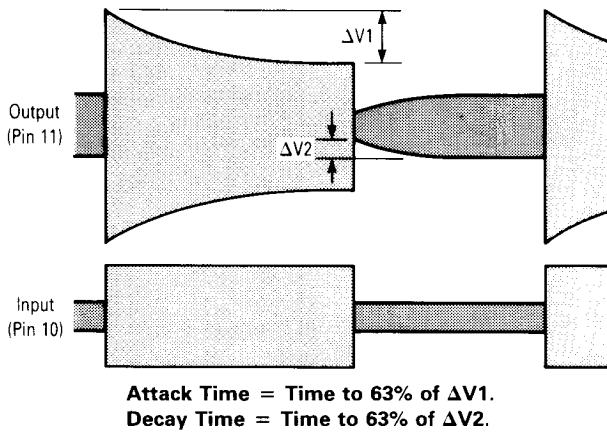

FIGURE 17 — ATTACK AND DECAY TIMES (EXPANDER)

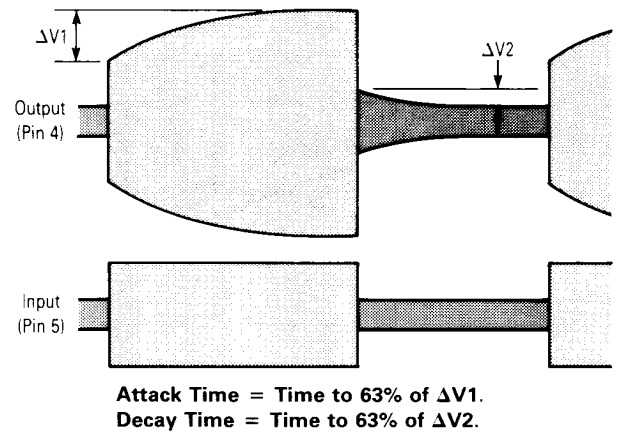

FIGURE 18 — MAXIMUM INPUT SIGNAL

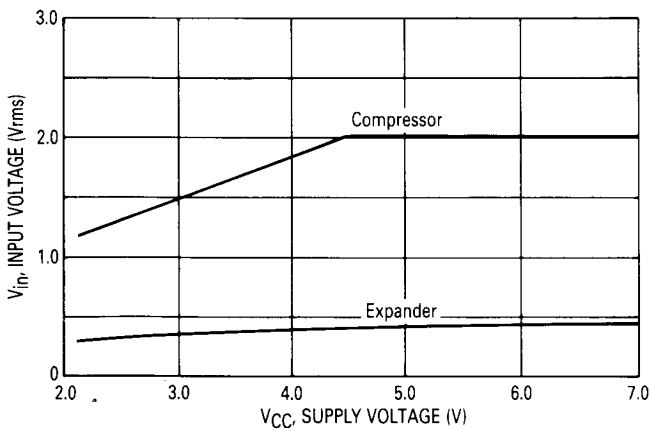
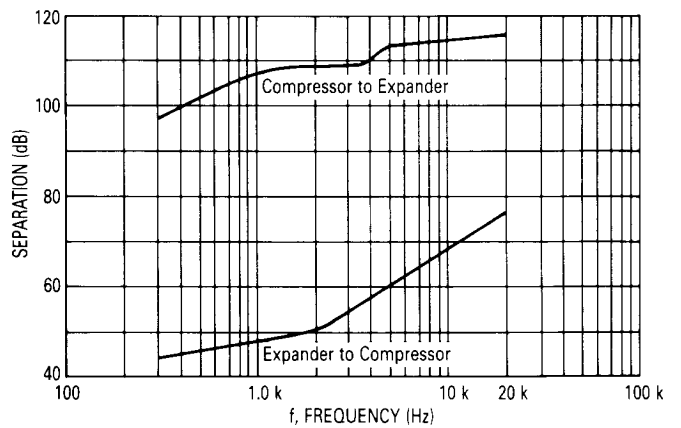
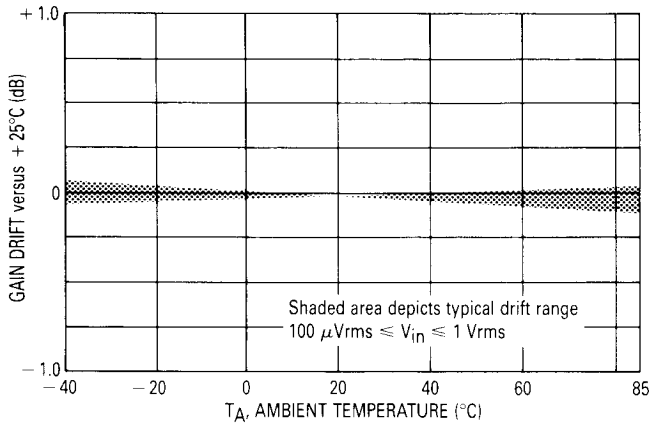

FIGURE 19 — CHANNEL SEPARATION



COMPRESSOR

FIGURE 20 — COMPRESSOR GAIN TRACKING versus TEMPERATURE



EXPANDER

FIGURE 21 — EXPANDER GAIN TRACKING versus TEMPERATURE

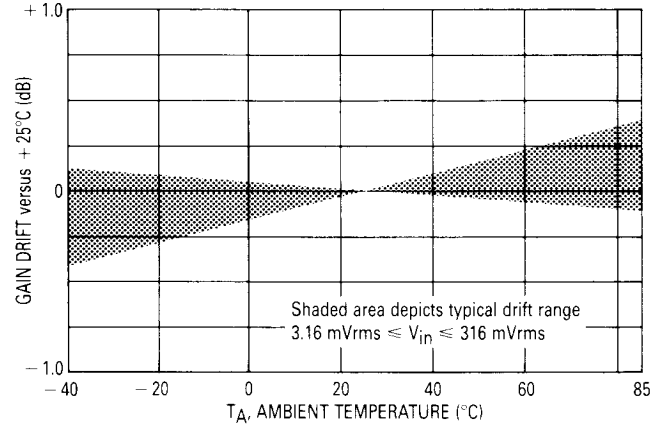

FIGURE 22 — COMPRESSOR THD versus TEMPERATURE

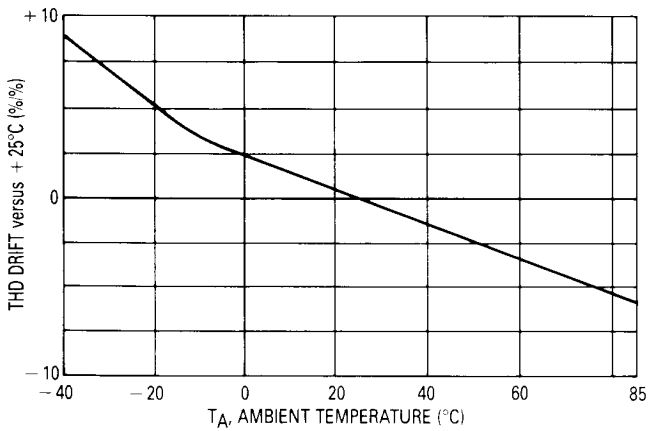
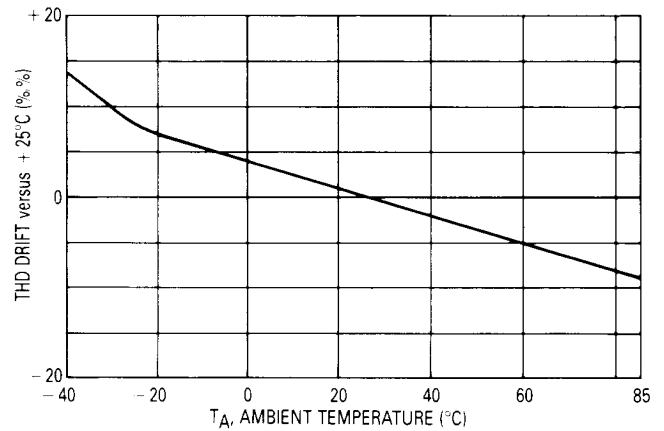

FIGURE 23 — EXPANDER THD versus TEMPERATURE



FUNCTIONAL DESCRIPTION

Introduction

The MC33110 compander (COMPRESSOR and exPANDER) is composed of two variable gain circuits which provide compression and expansion of the signal dynamic range. The compressor will take a signal with an 80 dB dynamic range (100 μV to 1.0 Vrms), and reduce that to a 40 dB dynamic range by attenuating strong signals, while amplifying low level signals. The expander does the opposite in that the 40 dB signal range is increased to a dynamic range of 80 dB by amplifying

strong signals and attenuating low level signals. The 0 dB level is internally set at 100 mVrms — that is the signal level which is neither amplified nor attenuated. Both circuits contain the necessary precision full wave rectifier, variable gain cell, and temperature compensated references required for accurate and stable performance.

Note: All dB values mentioned in this data sheet, unless otherwise noted, are referred to 100 mVrms.

Compressor

The compressor is an operational amplifier with a fixed input resistor and a variable gain cell in its feedback path as shown in Figure 24.

FIGURE 24 — COMPRESSOR

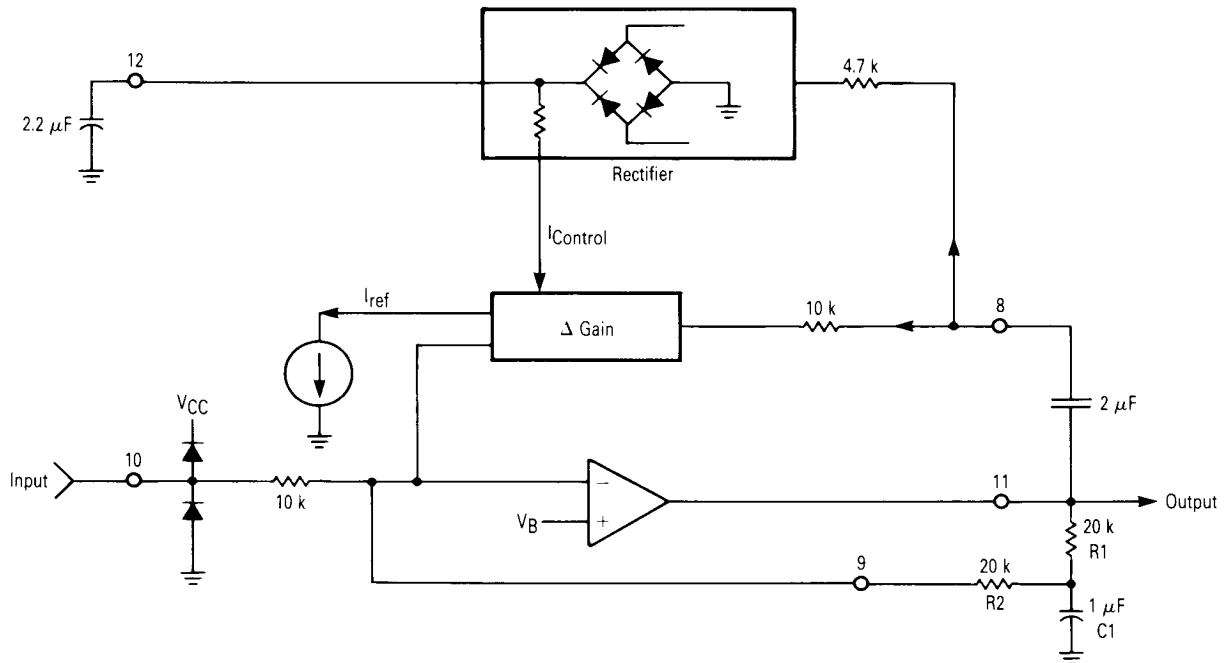

The amplifier output is sampled by the precision rectifier which, in turn, supplies a DC signal ($I_{Control}$), representative of the rectifier's AC signal, to the variable gain cell. The reference current (I_{ref}) is an internally generated precision current. The effective impedance of the variable gain cell varies with the ratio of the two currents, and decreases as $I_{Control}$ increases, thereby providing compression. The output is related to the input by the following equation:

$$V_{out} = 0.3162 \times \sqrt{V_{in}} \quad (\text{Equation 1})$$

In terms of dB levels, the relationship is:

$$V_{out(dB)} = 0.5 \times V_{in(dB)} \quad (\text{Equation 2})$$

where 0 dB = 100 mVrms (see Figure 2 and 4).

The inputs and output are internally biased at V_B ($V_{CC}/2$), and must therefore be capacitor coupled to external circuitry. Pin 10 input impedance is nominally 10 kΩ ($\pm 20\%$), and the maximum functional input signal is shown in Figure 18. Bias currents required by the op amp and the variable gain cell are internally supplied. Due to clamp diodes at the input (to V_{CC} and ground), the input signal must be maintained between the supply rails. If the input signal goes more than 0.5 V above V_{CC} or below ground, excessive currents will flow and distortion will show up at the output.

When no AC signals are present at the input, the variable gain cell will attempt to set such a high gain that the circuit may become unstable. For this reason resistors R_1 and R_2 , and capacitor C_1 are added to provide DC stability. The pole formed by R_1 , R_2 and C_1 should have

a pole frequency no more than 1/10th of the lowest frequency of interest. The pole frequency is calculated from:

$$f = \frac{R_1 + R_2}{2\pi \times R_1 R_2 C_1} \quad (\text{Equation 3})$$

for the component values shown, the pole frequency is ≈ 16 Hz.

Likewise, the capacitor between Pins 11 and 8 should be selected such that, in conjunction with the input impedance at Pin 8 ($\approx 3200 \Omega$, $\pm 20\%$), the resulting pole frequency is no more than 1/10 of the lowest frequency of interest. With the components shown, the pole frequency is < 30 Hz. This pole frequency is calculated from:

$$f = \frac{1}{2\pi \times 3.2 \text{ k} \times C} \quad (\text{Equation 4})$$

The output of the rectifier is filtered by the capacitor at Pin 12, which, in conjunction with an internal 10 k resistor, provides the time constant for the attack and decay times. Figure 14 and 16 indicate how the times vary with the capacitor value. The attack time for the compressor is always faster than the decay time due to the fact that the rectifier is fed from the output rather than the input. Since the output is initially larger than expected (immediately after the input has increased), the external capacitor is charged more quickly during the initial part of the time constant. When the input is decreased, the time constant is closer to that calculated by $t = RC$. If the attack and decay times are decreased by using a smaller capacitor, performance at low frequencies will degrade.

Expander

The expander is an operational amplifier with a fixed feedback resistor and a variable gain cell in its input path as shown in Figure 25.

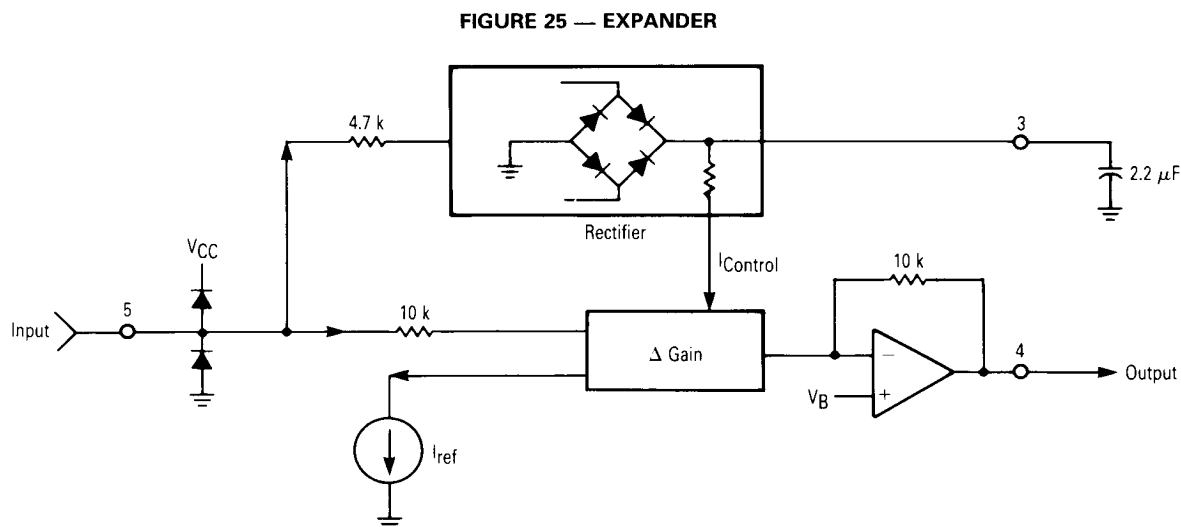

The input signal is sampled by the precision rectifier which, in turn, supplies a DC signal ($I_{Control}$), representative of the AC input signal, to the variable gain cell. The reference current (I_{ref}) is an internally generated precision current. The effective impedance of the variable gain cell varies with the ratio of the two currents, and decreases as $I_{Control}$ increases, thereby providing expansion. The output is related to the input by the following equation:

$$V_{out} = 10 \times (V_{in})^2 \quad (\text{Equation 5})$$

In terms of dB levels, the relationship is:

$$V_{out(dB)} = 2.0 \times V_{in(dB)} \quad (\text{Equation 6})$$

where 0 dB = 100 mV_{rms} (see Figure 3 and 5).

The inputs and output are internally biased at V_B ($V_{CC}/2$), and must therefore be capacitor coupled to external circuitry. The input impedance at Pin 5 is nominally 3.2 kΩ ($\pm 20\%$), and the maximum functional input signal is shown in Figure 18. Bias currents required by the op amp and the variable gain cell are internally supplied. Due to clamp diodes at the input (to V_{CC} and ground), the input signal must be maintained between the supply rails. If the input signal goes more than 0.5 V

above V_{CC} or below ground, excessive currents will flow, and distortion will show up at the output.

The output of the rectifier is filtered by the capacitor at Pin 3, which, in conjunction with an internal 10 k resistor, provides the time constant for the attack and decay times. Figure 15 and 17 indicate how the times vary with the capacitor value. If the attack and decay times are decreased by using a smaller capacitor, performance at low frequencies will degrade.

Power Supply

The MC33110 requires a power supply voltage between 2.1 V and 7.0 V, and a nominal current of 3.5 mA. The supply voltage should be well filtered and free of ripple. A minimum of 4.7 μF in parallel with a 0.01 μF capacitor is recommended for filtering and RF bypass.

V_B (Pin 6) is an internally generated mid supply reference, and is used internally as an AC ground. The external capacitor at Pin 6 filters this voltage, and its value affects the power supply noise rejection as shown in Figures 6 through 9. This reference voltage may be used to bias external circuitry as long as the current draw is limited to $<10 \mu A$.

APPLICATIONS INFORMATION

Signal-to-Noise Improvement

Among the basic reasons for the original development of compander type circuits was to improve the signal-to-noise ratio of long distance telecom circuits, and of voice circuits which are transmitted over RF links (CBs, walkie-talkies, cordless phones, etc.). Since much of the noise heard at the receiving end of a transmission is due to noise picked up, for example, in the airway portion of the RF link, the compressor was developed to increase the low-level signals at the transmitting end. Then any noise picked in the RF link would be a smaller percentage of the transmitted signal level. At the receiving end, the signal is then expanded back to its original level, retaining the same high signal-to-noise ratio. While the above explanation indicates it is not necessary to attenuate strong signals (at the transmitting end), a benefit of doing this is the reduced dynamic range which must be handled

by the system transmitter and receiver. The MC33110 was designed for a two-to-one compression and expansion, i.e. an 80 dB dynamic signal is compressed to a 40 dB dynamic range, transmitted to the receiving end and then expanded back to an 80 dB dynamic range.

The MC33110 compander is not limited to RF or long distance telephony applications. It can be used in any system requiring an improved signal-to-noise ratio such as telephones, speakerphones, tape recorders, digital recording, and many others.

Second Expander

Should the application require it, the MC33110 can be configured as two expanders by reconfiguring the compressor side as shown in Figure 26.

FIGURE 26 — SECOND EXPANDER

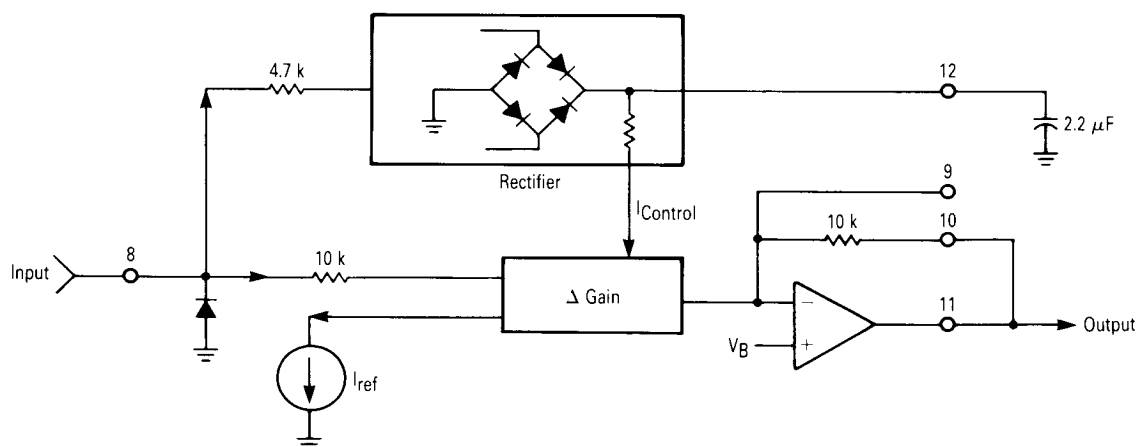

This circuit will provide the same performance as the expander at Pins 3 through 5.

Power Supplies, Grounding

The PC board layout, the quality of the power supplies and the ground system **at the IC** are very important in order to obtain proper operation. Noise, from any source, coming into the device on V_{CC} or ground, can cause a distorted output, or incorrect gain level.

V_{CC} must be decoupled to the appropriate ground **at the IC** (within 1" max) with a 4.7 μF capacitor and a 0.01 μF ceramic. A tantalum capacitor is recommended for the larger value if very high frequency noise is present since electrolytic capacitors simply have too much inductance at those frequencies. The quality of the power supply voltage should be checked at the IC with a high frequency scope. Noise spikes (always present if digital circuits are

near this IC) can easily exceed 400 mV, and if they get into the IC, the output can have noise or distortion. Noise can be reduced by inserting resistors and/or inductors between the supply and the IC.

If switching power supplies are used, there will usually be spikes of 0.5 V or greater at frequencies of 50 kHz to 1.0 MHz. These spikes are generally more difficult to reduce because of their greater energy content. In extreme cases, a three terminal regulator (MC78L05ACP), with appropriate high frequency filtering, should be used and dedicated to the analog portion of the circuit.

The ripple content of the supply should not allow its magnitude to exceed the values in the Recommended Operating Conditions table.

The PC board tracks supplying V_{CC} and ground to the MC33110 should preferably not be at the tail end of the bus distribution, after passing through a maze of digital circuitry. The analog circuitry containing the MC33110 should be close to the power supply, or the connector where the supply voltages enter the board. If V_{CC} is supplying considerable current to other parts of the board, then it is preferable to have dedicated lines from the supply or connector directly to the MC33110 and associated circuitry.

PC Board Layout

Although this device is intended for use in the audio frequency range, the amplifiers have a bandwidth of

≈ 300 kHz, and can therefore oscillate at frequencies outside the voiceband should there be excessive stray capacitance or other unintended feedback loops. A solid ground plane is strongly recommended to minimize coupling of any digital noise into the analog section. Use of wire wrapped boards should definitely be avoided.

Since many applications of the MC33110 compander involve voice transmission over RF links, care must be taken in the design of the product to keep RF signals out of the MC33110 and associated circuitry. This involves proper layout of the PC boards, the physical arrangement of the boards, shielding, proper RF ground, etc.

GLOSSARY

ATTACK TIME — The settling time for a circuit after its input signal has been increased.

ATTENUATION — A decrease in magnitude of a communication signal, usually expressed in dB.

BANDWIDTH — The range of information carrying frequencies of a communication system.

CHANNEL SEPARATION — The ability of one circuit to reject outputting signals which are being processed by another circuit. Also referred to as crosstalk, it is usually expressed in dB.

COMPANDER — A contraction of the words compressor and expander. A compander is composed of two circuits, one of each kind.

COMPRESSOR — A circuit which compresses or reduces the dynamic range of a signal by attenuating strong signals and amplifying low level signals.

dB — A power or voltage measurement unit, referred to another power or voltage. It is generally computed as:
 $10 \times \log (P_1/P_2)$ for power measurements, and
 $20 \times \log (V_1/V_2)$ for voltage measurements.

dBm — An indication of signal power. 1.0 mW across 600Ω or 0.775 V rms, is typically defined as 0 dBm for telecom applications. Any voltage level is converted to dBm by:

$$\begin{aligned} \text{dBm} &= 20 \times \log (V_{\text{rms}}/0.775), \text{ or} \\ \text{dBm} &= [20 \times \log (V_{\text{rms}})] + 2.22. \end{aligned}$$

dBm — Indicates a dBm measurement relative to 1.0 pW power level into 600Ω . Generally used for noise measurements, $0 \text{ dBm} = -90 \text{ dBm}$.

dBmC — Indicates a dBm measurement using a C-message weighting filter.

DECAY TIME — The settling time for a circuit after its input signal has been decreased.

EXPANDER — A circuit which expands or increases the dynamic range of a signal by amplifying strong signals and attenuating low level signals.

GAIN — The change in signal amplitude (increase or decrease) after passing through an amplifier, or other circuit stage. Usually expressed in dB, an increase is a positive number and a decrease is a negative number.

POWER SUPPLY REJECTION RATIO — The ability of a circuit to reject outputting noise, or ripple, which is present on the power supply lines. PSRR is usually expressed in dB.

SIGNAL-TO-NOISE RATIO — The ratio of the desired signal to unwanted signals (noise) within a defined frequency range. The larger the number, the better.

VOICEBAND — That portion of the audio frequency range used for transmission across the telephone system. Typically, it is 300 to 3400 Hz.

OUTLINE DIMENSIONS

P SUFFIX PLASTIC PACKAGE CASE 646-06

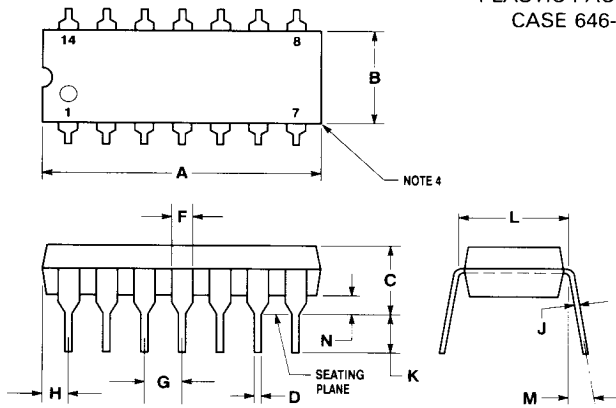

NOTES:

1. LEADS WITHIN 0.13 mm (0.005) RADIUS OF TRUE POSITION AT SEATING PLANE AT MAXIMUM MATERIAL CONDITION.
2. DIMENSION "L" TO CENTER OF LEADS WHEN FORMED PARALLEL.
3. DIMENSION "B" DOES NOT INCLUDE MOLD FLASH.
4. ROUNDED CORNERS OPTIONAL.

| DIM | MILLIMETERS | | INCHES | |
|-----|-------------|-------|-----------|-------|
| | MIN | MAX | MIN | MAX |
| A | 18.16 | 19.56 | 0.715 | 0.770 |
| B | 6.10 | 6.60 | 0.240 | 0.260 |
| C | 3.69 | 4.69 | 0.145 | 0.185 |
| D | 0.38 | 0.53 | 0.015 | 0.021 |
| F | 1.02 | 1.78 | 0.040 | 0.070 |
| G | 2.54 BSC | | 0.100 BSC | |
| H | 1.32 | 2.41 | 0.052 | 0.095 |
| J | 0.20 | 0.38 | 0.008 | 0.015 |
| K | 2.92 | 3.43 | 0.115 | 0.135 |
| L | 7.62 BSC | | 0.300 BSC | |
| M | 0° | 10° | 0° | 10° |
| N | 0.39 | 1.01 | 0.015 | 0.039 |

D SUFFIX PLASTIC PACKAGE CASE 751A-02 (SO-14)

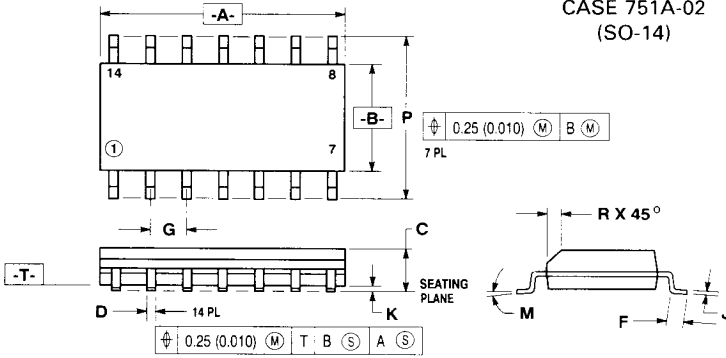

NOTES:

1. DIMENSIONS A AND B ARE DATUMS AND T IS A DATUM SURFACE.
2. DIMENSIONING AND TOLERANCING PER ANSI Y14.5M, 1982.
3. CONTROLLING DIMENSION: MILLIMETER.
4. DIMENSION A AND B DO NOT INCLUDE MOLD PROTRUSION.
5. MAXIMUM MOLD PROTRUSION 0.15 (0.006) PER SIDE.

| DIM | MILLIMETERS | | INCHES | |
|-----|-------------|------|-----------|-------|
| | MIN | MAX | MIN | MAX |
| A | 8.55 | 8.75 | 0.337 | 0.344 |
| B | 3.80 | 4.00 | 0.150 | 0.157 |
| C | 1.35 | 1.75 | 0.054 | 0.068 |
| D | 0.35 | 0.49 | 0.014 | 0.019 |
| F | 0.40 | 1.25 | 0.016 | 0.049 |
| G | 1.27 BSC | | 0.050 BSC | |
| J | 0.19 | 0.25 | 0.008 | 0.009 |
| K | 0.10 | 0.25 | 0.004 | 0.009 |
| M | 0° | 7° | 0° | 7° |
| P | 5.80 | 6.20 | 0.229 | 0.244 |
| R | 0.25 | 0.50 | 0.010 | 0.019 |

Motorola reserves the right to make changes without further notice to any products herein to improve reliability, function or design. Motorola does not assume any liability arising out of the application or use of any product or circuit described herein; neither does it convey any license under its patent rights nor the rights of others. Motorola products are not designed, intended, or authorized for use as components in systems intended for surgical implant into the body, or other applications intended to support or sustain life, or for any other application in which the failure of the Motorola product could create a situation where personal injury or death may occur. Should Buyer purchase or use Motorola products for any such unintended or unauthorized application, Buyer shall indemnify and hold Motorola and its officers, employees, subsidiaries, affiliates, and distributors harmless against all claims, costs, damages, and expenses, and reasonable attorney fees arising out of, directly or indirectly, any claim of personal injury or death associated with such unintended or unauthorized use, even if such claim alleges that Motorola was negligent regarding the design or manufacture of the part. Motorola and are registered trademarks of Motorola, Inc. Motorola, Inc. is an Equal Opportunity/Affirmative Action Employer.