



MC74AC161
MC74ACT161
MC74AC163
MC74ACT163

**SYNCHRONOUS
 PRESETTABLE
 BINARY COUNTER**

Synchronous Presettable Binary Counter

The MC74AC161/74ACT161 and MC74AC163/74ACT163 are high-speed synchronous modulo-16 binary counters. They are synchronously presettable for application in programmable dividers and have two types of Count Enable inputs plus a Terminal Count output for versatility in forming synchronous multistage counters. The MC74AC161/74ACT161 has an asynchronous Master Reset input that overrides all other inputs and forces the outputs LOW. The MC74AC163/74ACT163 has a Synchronous Reset input that overrides counting and parallel loading and allows the outputs to be simultaneously reset on the rising edge of the clock.

- Synchronous Counting and Loading
- High-Speed Synchronous Expansion
- Typical Count Rate of 125 MHz
- Outputs Source/Sink 24 mA
- 'ACT161 and 'ACT163 Have TTL Compatible Inputs

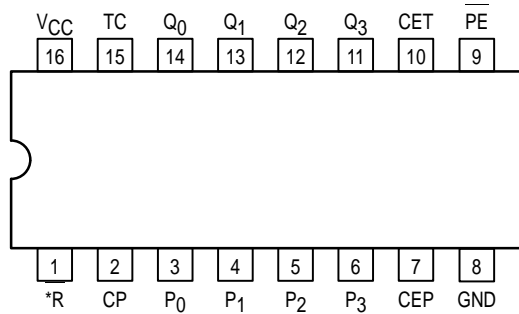

PIN NAMES

CEP	Count Enable Parallel Input
CET	Count Enable Trickle Input
CP	Clock Pulse Input
MR	('161) Asynchronous Master Reset Input
SR	('163) Synchronous Reset Input
P ₀ -P ₃	Parallel Data Inputs
PE	Parallel Enable Input
Q ₀ -Q ₃	Flip-Flop Outputs
TC	Terminal Count Output

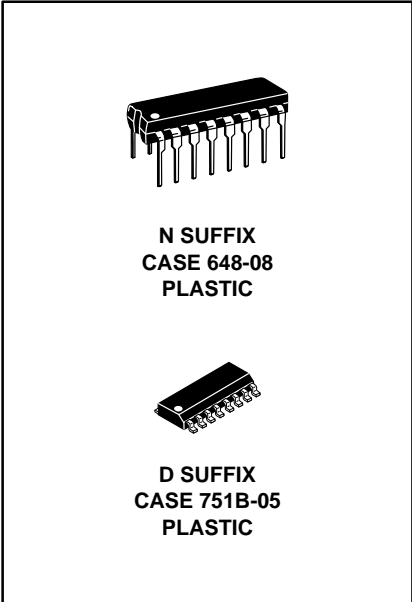

LOGIC SYMBOL

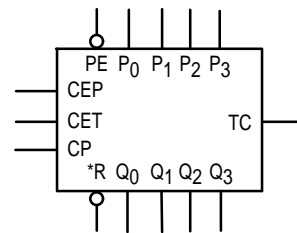

*MR for '161
 *SR for '163

MC74AC161 MC74ACT161 MC74AC163 MC74ACT163

FUNCTIONAL DESCRIPTION

The MC74AC161/74ACT161 and MC74AC163/74ACT163 count modulo-16 binary sequence. From state 15 (HHHH) they increment to state 0 (LLLL). The clock inputs of all flip-flops are driven in parallel through a clock buffer. Thus all changes of the Q outputs (except due to Master Reset of the '161) occur as a result of, and synchronous with, the LOW-to-HIGH transition of the CP input signal. The circuits have four fundamental modes of operation, in order of precedence: asynchronous reset ('161), synchronous reset ('163), parallel load, count-up and hold. Five control inputs — Master Reset (MR, '161), Synchronous Reset (SR, '163), Parallel Enable (PE), Count Enable Parallel (CEP) and Count Enable Trickle (CET) — determine the mode of operation, as shown in the Mode Select Table. A LOW signal on MR overrides all other inputs and asynchronously forces all outputs LOW. A LOW signal on SR overrides counting and parallel loading and allows all outputs to go LOW on the next rising edge of CP. A LOW signal on PE overrides counting and allows information on the Parallel Data (P_n) inputs to be loaded into the flip-flops on the next rising edge of CP. With PE and MR

('161) or SR ('163) HIGH, CEP and CET permit counting when both are HIGH. Conversely, a LOW signal on either CEP or CET inhibits counting.

The MC74AC161/74ACT161 and MC74AC163/74ACT163 use D-type edge-triggered flip-flops and changing the SR, PE, CEP and CET inputs when the CP is in either state does not cause errors, provided that the recommended setup and hold times, with respect to the rising edge of CP, are observed.

The Terminal Count (TC) output is HIGH when CET is HIGH and counter is in state 15. To implement synchronous multistage counters, the TC outputs can be used with the CEP and CET inputs in two different ways. Please refer to the MC74AC568 data sheet. The TC output is subject to decoding spikes due to internal race conditions and is therefore not recommended for use as a clock or asynchronous reset for flip-flops, counters or registers.

Logic Equations: Count Enable = CEP • CET • PE
 TC = Q₀ • Q₁ • Q₂ • Q₃ • CET

MODE SELECT TABLE

*SR	PE	CET	CEP	Action on the Rising Clock Edge ()
L	X	X	X	Reset (Clear)
H	L	X	X	Load (P _n → Q _n)
H	H	H	H	Count (Increment)
H	H	L	X	No Change (Hold)
H	H	X	L	No Change (Hold)

*For '163 only
 H = HIGH Voltage Level
 L = LOW Voltage Level
 X = Immaterial

STATE DIAGRAM

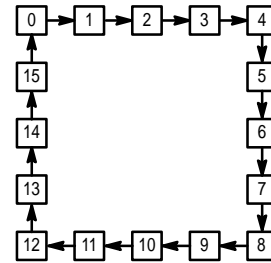

LOGIC DIAGRAM

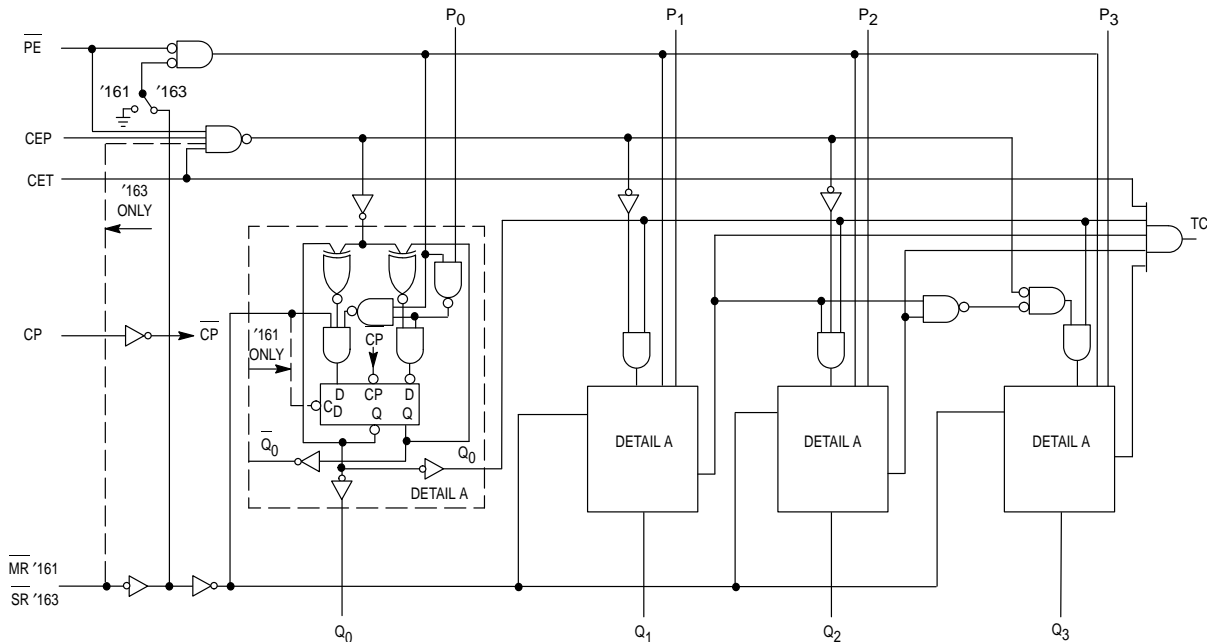

Please note that this diagram is provided only for the understanding of logic operations and should not be used to estimate propagation delays.

MC74AC161 MC74ACT161 MC74AC163 MC74ACT163

MAXIMUM RATINGS*

Symbol	Parameter	Value	Unit
V _{CC}	DC Supply Voltage (Referenced to GND)	-0.5 to +7.0	V
V _{in}	DC Input Voltage (Referenced to GND)	-0.5 to V _{CC} +0.5	V
V _{out}	DC Output Voltage (Referenced to GND)	-0.5 to V _{CC} +0.5	V
I _{in}	DC Input Current, per Pin	±20	mA
I _{out}	DC Output Sink/Source Current, per Pin	±50	mA
I _{CC}	DC V _{CC} or GND Current per Output Pin	±50	mA
T _{stg}	Storage Temperature	-65 to +150	°C

* Maximum Ratings are those values beyond which damage to the device may occur. Functional operation should be restricted to the Recommended Operating Conditions.

RECOMMENDED OPERATING CONDITIONS

Symbol	Parameter	Min	Typ	Max	Unit	
V _{CC}	Supply Voltage	'AC	2.0	5.0	6.0	V
		'ACT	4.5	5.0	5.5	
V _{in} , V _{out}	DC Input Voltage, Output Voltage (Ref. to GND)	0		V _{CC}	V	
t _r , t _f	Input Rise and Fall Time (Note 1) 'AC Devices except Schmitt Inputs	V _{CC} @ 3.0 V		150		ns/V
		V _{CC} @ 4.5 V		40		
		V _{CC} @ 5.5 V		25		
t _r , t _f	Input Rise and Fall Time (Note 2) 'ACT Devices except Schmitt Inputs	V _{CC} @ 4.5 V		10		ns/V
		V _{CC} @ 5.5 V		8.0		
T _J	Junction Temperature (PDIP)			140	°C	
T _A	Operating Ambient Temperature Range	-40	25	85	°C	
I _{OH}	Output Current — High			-24	mA	
I _{OL}	Output Current — Low			24	mA	

1. V_{in} from 30% to 70% V_{CC}; see individual Data Sheets for devices that differ from the typical input rise and fall times.

2. V_{in} from 0.8 V to 2.0 V; see individual Data Sheets for devices that differ from the typical input rise and fall times.

MC74AC161 MC74ACT161 MC74AC163 MC74ACT163

DC CHARACTERISTICS

Symbol	Parameter	V _{CC} (V)	74AC		74AC		Unit	Conditions
			T _A = +25°C		T _A = -40°C to +85°C			
			Typ	Guaranteed Limits				
V _{IH}	Minimum High Level Input Voltage	3.0	1.5	2.1	2.1	V	V _{OUT} = 0.1 V or V _{CC} - 0.1 V	
		4.5	2.25	3.15	3.15			
		5.5	2.75	3.85	3.85			
V _{IL}	Maximum Low Level Input Voltage	3.0	1.5	0.9	0.9	V	V _{OUT} = 0.1 V or V _{CC} - 0.1 V	
		4.5	2.25	1.35	1.35			
		5.5	2.75	1.65	1.65			
V _{OH}	Minimum High Level Output Voltage	3.0	2.99	2.9	2.9	V	I _{OUT} = -50 μA	
		4.5	4.49	4.4	4.4			
		5.5	5.49	5.4	5.4			
		3.0		2.56	2.46	V	*V _{IN} = V _{IL} or V _{IH} -12 mA I _{OH} -24 mA -24 mA	
		4.5		3.86	3.76			
		5.5		4.86	4.76			
V _{OL}	Maximum Low Level Output Voltage	3.0	0.002	0.1	0.1	V	I _{OUT} = 50 μA	
		4.5	0.001	0.1	0.1			
		5.5	0.001	0.1	0.1			
		3.0		0.36	0.44	V	*V _{IN} = V _{IL} or V _{IH} 12 mA I _{OL} 24 mA 24 mA	
		4.5		0.36	0.44			
		5.5		0.36	0.44			
I _{IN}	Maximum Input Leakage Current	5.5		±0.1	±1.0	μA	V _I = V _{CC} , GND	
I _{OLD}	†Minimum Dynamic Output Current	5.5			75	mA	V _{OLD} = 1.65 V Max	
I _{OHD}		5.5			-75	mA	V _{OHD} = 3.85 V Min	
I _{CC}	Maximum Quiescent Supply Current	5.5		8.0	80	μA	V _{IN} = V _{CC} or GND	

* All outputs loaded; thresholds on input associated with output under test.

† Maximum test duration 2.0 ms, one output loaded at a time.

Note: I_{IN} and I_{CC} @ 3.0 V are guaranteed to be less than or equal to the respective limit @ 5.5 V V_{CC}.

MC74AC161 MC74ACT161 MC74AC163 MC74ACT163

AC CHARACTERISTICS (For Figures and Waveforms — See Section 3)

Symbol	Parameter	V _{CC} * (V)	74AC161			74AC161		Unit	Fig. No.
			T _A = +25°C C _L = 50 pF			T _A = -40°C to +85°C C _L = 50 pF			
			Min	Typ	Max	Min	Max		
f _{max}	Maximum Count Frequency	3.3 5.0	70 110	111 167		60 95		MHz	3-3
t _{PLH}	Propagation Delay CP to Q _n (PE Input HIGH or LOW)	3.3 5.0	2.0 1.5	7.0 5.0	12.0 9.0	1.5 1.0	13.5 9.5	ns	3-6
t _{PHL}	Propagation Delay CP to Q _n (PE Input HIGH or LOW)	3.3 5.0	1.5 1.5	7.0 5.0	12.0 9.5	1.5 1.5	13.0 10.0	ns	3-6
t _{PLH}	Propagation Delay CP to TC	3.3 5.0	3.0 2.0	9.0 6.0	15.0 10.5	2.5 1.5	16.5 11.5	ns	3-6
t _{PHL}	Propagation Delay CP to TC	3.3 5.0	3.5 2.0	8.5 6.5	14.0 11.0	2.5 2.0	15.5 11.5	ns	3-6
t _{PLH}	Propagation Delay CET to TC	3.3 5.0	2.0 1.5	5.5 3.5	9.5 6.5	1.5 1.0	11.0 7.5	ns	3-6
t _{PHL}	Propagation Delay CET to TC	3.3 5.0	2.5 2.0	6.5 5.0	11.0 8.5	2.0 1.5	12.5 9.5	ns	3-6
t _{PHL}	Propagation Delay MR to Q _n	3.3 5.0	2.0 1.5	6.0 5.5	12.0 9.5	1.5 1.5	13.5 10.0	ns	3-6
t _{PHL}	Propagation Delay MR to TC	3.3 5.0	3.5 2.5	10.0 8.5	15.0 13.0	3.0 2.5	17.5 13.5	ns	3-6

* Voltage Range 3.3 V is 3.3 V ±0.3 V.
Voltage Range 5.0 V is 5.0 V ±0.5 V.

AC CHARACTERISTICS (For Figures and Waveforms — See Section 3)

Symbol	Parameter	V _{CC} * (V)	74AC163			74AC163		Unit	Fig. No.
			T _A = +25°C C _L = 50 pF			T _A = -40°C to +85°C C _L = 50 pF			
			Min	Typ	Max	Min	Max		
f _{max}	Maximum Count Frequency	3.3 5.0	70 110	95 140		60 95		MHz	3-3
t _{PLH}	Propagation Delay CP to Q _n (PE Input HIGH or LOW)	3.3 5.0	2.0 1.5	7.5 5.5	12.5 9.0	1.5 1.0	13.5 9.5	ns	3-6
t _{PHL}	Propagation Delay CP to Q _n (PE Input HIGH or LOW)	3.3 5.0	1.5 1.5	8.5 6.0	12.0 9.5	1.5 1.5	13.0 10.0	ns	3-6
t _{PLH}	Propagation Delay CP to TC	3.3 5.0	3.0 2.0	9.5 7.0	15.0 10.5	2.5 1.5	16.5 11.5	ns	3-6
t _{PHL}	Propagation Delay CP to TC	3.3 5.0	3.5 2.0	11.0 8.0	14.0 11.0	2.5 2.0	15.5 11.5	ns	3-6
t _{PLH}	Propagation Delay CET to TC	3.3 5.0	2.0 1.5	7.5 5.5	9.5 6.5	1.5 1.0	11.0 7.5	ns	3-6
t _{PHL}	Propagation Delay CET to TC	3.3 5.0	2.5 2.0	8.5 6.0	11.0 8.5	2.0 1.5	12.5 9.5	ns	3-6

* Voltage Range 3.3 V is 3.3 V ±0.3 V.
Voltage Range 5.0 V is 5.0 V ±0.5 V.

MC74AC161 MC74ACT161 MC74AC163 MC74ACT163

AC OPERATING REQUIREMENTS

Symbol	Parameter	V _{CC} * (V)	74AC161		74ACT161		Unit	Fig. No.
			T _A = +25°C C _L = 50 pF		T _A = -40°C to +85°C C _L = 50 pF			
			Typ	Guaranteed Minimum				
t _s	Setup Time, HIGH or LOW P _n to CP	3.3	6.0	13.5	16.0	ns	3-9	
		5.0	3.5	8.5	10.5			
t _h	Hold Time, HIGH or LOW P _n to CP	3.3	-7.0	-1.0	-0.5	ns	3-9	
		5.0	-4.0	0	0			
t _s	Setup Time, HIGH or LOW PE to CP	3.3	6.5	11.5	14.0	ns	3-9	
		5.0	4.0	7.5	8.5			
t _h	Hold Time, HIGH or LOW PE to CP	3.3	-6.0	0	0	ns	3-9	
		5.0	-3.5	0.5	1.0			
t _s	Setup Time, HIGH or LOW CEP or CET to CP	3.3	3.0	6.0	7.0	ns	3-9	
		5.0	2.0	4.5	5.0			
t _h	Hold Time, HIGH or LOW CEP or CET to CP	3.3	-3.5	0	0	ns	3-9	
		5.0	-2.0	0	0.5			
t _w	Clock Pulse Width (Load) HIGH or LOW	3.3	2.0	3.5	4.0	ns	3-6	
		5.0	2.0	2.5	3.0			
t _w	Clock Pulse Width (Count) HIGH or LOW	3.3	2.0	4.0	4.5	ns	3-6	
		5.0	2.0	3.0	3.5			
t _w	MR Pulse Width, LOW	3.3	3.0	5.5	7.5	ns	3-6	
		5.0	2.5	4.5	6.0			
t _{rec}	Recovery Time MR to CP	3.3	-2.0	-0.5	0	ns	3-9	
		5.0	-1.0	0	0.5			

* Voltage Range 3.3 V is 3.3 V ±0.3 V.

Voltage Range 5.0 V is 5.0 V ±0.5 V.

MC74AC161 MC74ACT161 MC74AC163 MC74ACT163

AC OPERATING REQUIREMENTS

Symbol	Parameter	V _{CC} * (V)	74AC163		74AC163		Unit	Fig. No.
			T _A = +25°C C _L = 50 pF		T _A = -40°C to +85°C C _L = 50 pF			
			Typ	Guaranteed Minimum				
t _s	Setup Time, HIGH or LOW P _n to CP	3.3	5.5	13.5	16.0	ns	3-9	
		5.0	4.0	8.5	10.5			
t _h	Hold Time, HIGH or LOW P _n to CP	3.3	-7.0	-1.0	-0.5	ns	3-9	
		5.0	-5.0	0	0			
t _s	Setup Time, HIGH or LOW SR to CP	3.3	5.5	14	16.5	ns	3-9	
		5.0	4.0	9.5	11.0			
t _h	Hold Time, HIGH or LOW SR to CP	3.3	-7.5	-1.0	-0.5	ns	3-9	
		5.0	-5.5	-0.5	0			
t _s	Setup Time, HIGH or LOW PE to CP	3.3	5.5	11.5	14.0	ns	3-9	
		5.0	4.0	7.5	8.5			
t _h	Hold Time, HIGH or LOW PE to CP	3.3	-7.5	-1.0	-0.5	ns	3-9	
		5.0	-5.0	-0.5	0			
t _s	Setup Time, HIGH or LOW CEP or CET to CP	3.3	3.5	6.0	7.0	ns	3-9	
		5.0	2.5	4.5	5.0			
t _h	Hold Time, HIGH or LOW CEP or CET to CP	3.3	-4.5	0	0	ns	3-9	
		5.0	-3.0	0	0.5			
t _w	Clock Pulse Width (Load) HIGH or LOW	3.3	3.0	3.5	4.0	ns	3-6	
		5.0	2.0	2.5	3.0			
t _w	Clock Pulse Width (Count) HIGH or LOW	3.3	3.0	4.0	4.5	ns	3-6	
		5.0	2.0	3.0	3.5			

* Voltage Range 3.3 V is 3.3 V ±0.3 V.
Voltage Range 5.0 V is 5.0 V ±0.5 V.

MC74AC161 MC74ACT161 MC74AC163 MC74ACT163

DC CHARACTERISTICS

Symbol	Parameter	V _{CC} (V)	74ACT		74ACT		Unit	Conditions
			T _A = +25°C		T _A = -40°C to +85°C			
			Typ	Guaranteed Limits				
V _{IH}	Minimum High Level Input Voltage	4.5	1.5	2.0	2.0	V	V _{OUT} = 0.1 V or V _{CC} - 0.1 V	
		5.5	1.5	2.0	2.0			
V _{IL}	Maximum Low Level Input Voltage	4.5	1.5	0.8	0.8	V	V _{OUT} = 0.1 V or V _{CC} - 0.1 V	
		5.5	1.5	0.8	0.8			
V _{OH}	Minimum High Level Output Voltage	4.5	4.49	4.4	4.4	V	I _{OUT} = -50 μA	
		5.5	5.49	5.4	5.4			
		4.5		3.86	3.76	V	*V _{IN} = V _{IL} or V _{IH} -24 mA I _{OH} -24 mA	
		5.5		4.86	4.76			
V _{OL}	Maximum Low Level Output Voltage	4.5	0.001	0.1	0.1	V	I _{OUT} = 50 μA	
		5.5	0.001	0.1	0.1			
		4.5		0.36	0.44	V	*V _{IN} = V _{IL} or V _{IH} 24 mA I _{OL} 24 mA	
		5.5		0.36	0.44			
I _{IN}	Maximum Input Leakage Current	5.5		±0.1	±1.0	μA	V _I = V _{CC} , GND	
ΔI _{CCT}	Additional Max. I _{CC} /Input	5.5	0.6		1.5	mA	V _I = V _{CC} - 2.1 V	
I _{OLD}	†Minimum Dynamic Output Current	5.5			75	mA	V _{OLD} = 1.65 V Max	
I _{OHD}		5.5			-75	mA	V _{OHD} = 3.85 V Min	
I _{CC}	Maximum Quiescent Supply Current	5.5		8.0	80	μA	V _{IN} = V _{CC} or GND	

* All outputs loaded; thresholds on input associated with output under test.

† Maximum test duration 2.0 ms, one output loaded at a time.

MC74AC161 MC74ACT161 MC74AC163 MC74ACT163

AC CHARACTERISTICS (For Figures and Waveforms — See Section 3)

Symbol	Parameter	V _{CC} * (V)	74ACT161			74ACT161		Unit	Fig. No.
			T _A = +25°C C _L = 50 pF			T _A = -40°C to +85°C C _L = 50 pF			
			Min	Typ	Max	Min	Max		
f _{max}	Maximum Count Frequency	5.0	115	125		100		MHz	3-3
t _{PLH}	Propagation Delay CP to Q _n (PE Input HIGH or LOW)	5.0	1.5	8.0	9.5	1.5	10.5	ns	3-6
t _{PHL}	Propagation Delay CP or Q _n (PE Input HIGH or LOW)	5.0	1.5	8.0	10.5	1.5	11.5	ns	3-6
t _{PLH}	Propagation Delay CP to TC	5.0	2.0	11.0	11.0	1.5	12.5	ns	3-6
t _{PHL}	Propagation Delay CP to TC	5.0	1.5	11.0	12.5	1.5	13.5	ns	3-6
t _{PLH}	Propagation Delay CET to TC	5.0	1.5	7.5	8.5	1.5	10.0	ns	3-6
t _{PHL}	Propagation Delay CET to TC	5.0	1.5	8.0	9.5	1.5	10.5	ns	3-6
t _{PHL}	Propagation Delay MR to Q _n	5.0	1.5	8.0	10.0	1.5	11.0	ns	3-6
t _{PHL}	Propagation Delay MR to TC	5.0	2.5	10.0	13.5	2.0	14.5	ns	3-6

* Voltage Range 5.0 V is 5.0 V ±0.5 V.

AC CHARACTERISTICS (For Figures and Waveforms — See Section 3)

Symbol	Parameter	V _{CC} * (V)	74ACT163			74ACT163		Unit	Fig. No.
			T _A = +25°C C _L = 50 pF			T _A = -40°C to +85°C C _L = 50 pF			
			Min	Typ	Max	Min	Max		
f _{max}	Maximum Count Frequency	5.0	120	140		105		MHz	3-3
t _{PLH}	Propagation Delay CP to Q _n (PE Input HIGH or LOW)	5.0	1.5	5.5	10.0	1.5	11.0	ns	3-6
t _{PHL}	Propagation Delay CP to Q _n (PE Input HIGH or LOW)	5.0	1.5	6.0	11.0	1.5	12.0	ns	3-6
t _{PLH}	Propagation Delay CP to TC	5.0	2.5	7.0	11.5	2.0	13.5	ns	3-6
t _{PHL}	Propagation Delay CP to TC	5.0	3.0	8.0	13.5	2.0	15.0	ns	3-6
t _{PLH}	Propagation Delay CET to TC	5.0	2.0	5.5	9.0	1.5	10.5	ns	3-6
t _{PHL}	Propagation Delay CET to TC	5.0	2.0	6.0	10.0	2.0	11.0	ns	3-6

* Voltage Range 5.0 V is 5.0 V ±0.5 V.

MC74AC161 MC74ACT161 MC74AC163 MC74ACT163

AC OPERATING REQUIREMENTS

Symbol	Parameter	V _{CC} * (V)	74ACT161		74ACT161		Unit	Fig. No.
			T _A = +25°C C _L = 50 pF		T _A = -40°C to +85°C C _L = 50 pF			
			Typ	Guaranteed Minimum				
t _s	Setup Time, HIGH or LOW P _n to CP	5.0	7.0	9.5	11.5	ns	3-9	
t _h	Hold Time, HIGH or LOW P _n to CP	5.0	-3.0	0	0	ns	3-9	
t _s	Setup Time, HIGH or LOW PE to CP	5.0	6.0	8.5	9.5	ns	3-9	
t _h	Hold Time, HIGH or LOW PE to CP	5.0	-3.5	-0.5	-0.5	ns	3-9	
t _s	Setup Time, HIGH or LOW CEP or CET to CP	5.0	4.0	5.5	6.5	ns	3-9	
t _h	Hold Time, HIGH or LOW CEP or CET to CP	5.0	-2.0	0	0	ns	3-9	
t _w	Clock Pulse Width (Load) HIGH or LOW	5.0	2.0	3.0	3.5	ns	3-6	
t _w	Clock Pulse Width (Count) HIGH or LOW	5.0	2.0	3.0	3.5	ns	3-6	
t _w	MR Pulse Width, LOW	5.0	3.0	3.0	7.5	ns	3-6	
t _{rec}	Recovery Time MR to CP	5.0	0	0	0.5	ns	3-9	

* Voltage Range 5.0 V is 5.0 V ±0.5 V.

MC74AC161 MC74ACT161 MC74AC163 MC74ACT163

AC OPERATING REQUIREMENTS

Symbol	Parameter	V _{CC} * (V)	74ACT163		74ACT163		Unit	Fig. No.
			T _A = +25°C C _L = 50 pF		T _A = -40°C to +85°C C _L = 50 pF			
			Typ	Guaranteed Minimum				
t _s	Setup Time, HIGH or LOW P _n to CP	5.0	4.0	10.0	12.0	ns	3-9	
t _h	Hold Time, HIGH or LOW P _n to CP	5.0	-5.0	0.5	0.5	ns	3-9	
t _s	Setup Time, HIGH or LOW SR to CP	5.0	4.0	10.0	11.5	ns	3-9	
t _h	Hold Time, HIGH or LOW SR to CP	5.0	-5.5	-0.5	-0.5	ns	3-9	
t _s	Setup Time, HIGH or LOW PE to CP	5.0	4.0	8.5	10.5	ns	3-9	
t _h	Hold Time, HIGH or LOW PE to CP	5.0	-5.5	-0.5	0	ns	3-9	
t _s	Setup Time, HIGH or LOW CEP or CET to CP	5.0	2.5	5.5	6.5	ns	3-9	
t _h	Hold Time, HIGH or LOW CEP or CET to CP	5.0	-3.0	0	0.5	ns	3-9	
t _w	Clock Pulse Width HIGH or LOW	5.0	2.0	3.5	3.5	ns	3-6	
t _w	Clock Pulse Width (Count) HIGH or LOW	5.0	2.0	3.5	3.5	ns	3-6	

* Voltage Range 5.0 V is 5.0 V ±0.5 V.

CAPACITANCE

Symbol	Parameter	Value Typ	Unit	Test Conditions
C _{IN}	Input Capacitance	4.5	pF	V _{CC} = 5.0 V
CPD	Power Dissipation Capacitance	45	pF	V _{CC} = 5.0 V

MC74AC161 MC74ACT161 MC74AC163 MC74ACT163

OUTLINE DIMENSIONS

N SUFFIX PLASTIC DIP PACKAGE CASE 648-08 ISSUE R

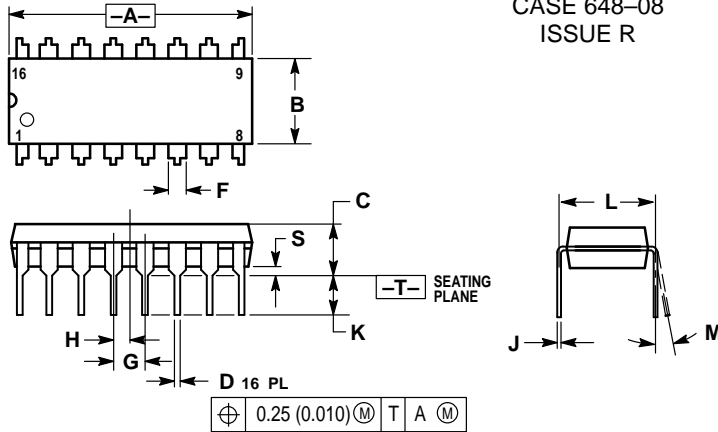

- NOTES:
1. DIMENSIONING AND TOLERANCING PER ANSI Y14.5M, 1982.
 2. CONTROLLING DIMENSION: INCH.
 3. DIMENSION L TO CENTER OF LEADS WHEN FORMED PARALLEL.
 4. DIMENSION B DOES NOT INCLUDE MOLD FLASH.
 5. ROUNDED CORNERS OPTIONAL.

DIM	INCHES		MILLIMETERS	
	MIN	MAX	MIN	MAX
A	0.740	0.770	18.80	19.55
B	0.250	0.270	6.35	6.85
C	0.145	0.175	3.69	4.44
D	0.015	0.021	0.39	0.53
F	0.040	0.70	1.02	1.77
G	0.100 BSC		2.54 BSC	
H	0.050 BSC		1.27 BSC	
J	0.008	0.015	0.21	0.38
K	0.110	0.130	2.80	3.30
L	0.295	0.305	7.50	7.74
M	0°	10°	0°	10°
S	0.020	0.040	0.51	1.01

D SUFFIX PLASTIC SOIC PACKAGE CASE 751B-05 ISSUE J

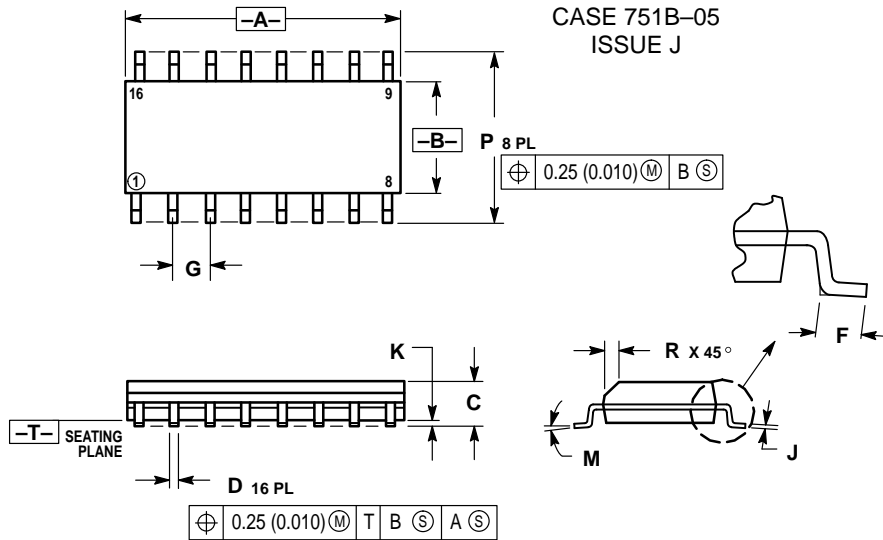

- NOTES:
1. DIMENSIONING AND TOLERANCING PER ANSI Y14.5M, 1982.
 2. CONTROLLING DIMENSION: MILLIMETER.
 3. DIMENSIONS A AND B DO NOT INCLUDE MOLD PROTRUSION.
 4. MAXIMUM MOLD PROTRUSION 0.15 (0.006) PER SIDE.
 5. DIMENSION D DOES NOT INCLUDE DAMBAR PROTRUSION. ALLOWABLE DAMBAR PROTRUSION SHALL BE 0.127 (0.005) TOTAL IN EXCESS OF THE D DIMENSION AT MAXIMUM MATERIAL CONDITION.

DIM	MILLIMETERS		INCHES	
	MIN	MAX	MIN	MAX
A	9.80	10.00	0.386	0.393
B	3.80	4.00	0.150	0.157
C	1.35	1.75	0.054	0.068
D	0.35	0.49	0.014	0.019
F	0.40	1.25	0.016	0.049
G	1.27 BSC		0.050 BSC	
J	0.19	0.25	0.008	0.009
K	0.10	0.25	0.004	0.009
M	0°	7°	0°	7°
P	5.80	6.20	0.229	0.244
R	0.25	0.50	0.010	0.019

Motorola reserves the right to make changes without further notice to any products herein. Motorola makes no warranty, representation or guarantee regarding the suitability of its products for any particular purpose, nor does Motorola assume any liability arising out of the application or use of any product or circuit, and specifically disclaims any and all liability, including without limitation consequential or incidental damages. "Typical" parameters can and do vary in different applications. All operating parameters, including "Typicals" must be validated for each customer application by customer's technical experts. Motorola does not convey any license under its patent rights nor the rights of others. Motorola products are not designed, intended, or authorized for use as components in systems intended for surgical implant into the body, or other applications intended to support or sustain life, or for any other application in which the failure of the Motorola product could create a situation where personal injury or death may occur. Should Buyer purchase or use Motorola products for any such unintended or unauthorized application, Buyer shall indemnify and hold Motorola and its officers, employees, subsidiaries, affiliates, and distributors harmless against all claims, costs, damages, and expenses, and reasonable attorney fees arising out of, directly or indirectly, any claim of personal injury or death associated with such unintended or unauthorized use, even if such claim alleges that Motorola was negligent regarding the design or manufacture of the part. Motorola and  are registered trademarks of Motorola, Inc. Motorola, Inc. is an Equal Opportunity/Affirmative Action Employer.

How to reach us:

USA/EUROPE: Motorola Literature Distribution;
P.O. Box 20912; Phoenix, Arizona 85036. 1-800-441-2447

JAPAN: Nippon Motorola Ltd.; Tatsumi-SPD-JLDC, Toshikatsu Otsuki,
6F Seibu-Butsuryu-Center, 3-14-2 Tatsumi Koto-Ku, Tokyo 135, Japan. 03-3521-8315

MFAX: RMFA00@email.sps.mot.com -TOUCHTONE (602) 244-6609
INTERNET: http://Design-NET.com

HONG KONG: Motorola Semiconductors H.K. Ltd.; 8B Tai Ping Industrial Park,
51 Ting Kok Road, Tai Po, N.T., Hong Kong. 852-26629298



MC74AC161/D

