

Ribbon Cable Connectors

1.27mm (.050") Pitch – Picoflex™ PF-50

IDT Connectors.....	G-2
Headers.....	G-3 to G-7
Custom Cable Harness.....	G-7 to G-8

Connectors for 1.27mm (.050") Pitch Ribbon Cable – QF-50™

Receptacles.....	G-11 to G-12
Strain Relief.....	G-12
Shrouded Headers.....	G-13 to G-16

2.54mm (.010") Pitch Connectors – SL™.....	G-17
--	------

Wire Traps

2.00mm (.079") Pitch.....	G-18
---------------------------	------

Visit www.molex.com to access more part numbers and product information, download sales drawings, product specifications, 3D models, place sample requests, and more.

1.27mm (.050") Pitch Picoflex™ PF-50 Connector

90327
Low Profile, IDT

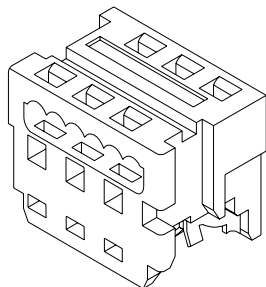

Features and Benefits

- 1-piece housing assures precise positioning of cable
- Molded-in polarization
- 4 points of contact with ribbon cable
- Preloaded contacts
- Accepts 28 or 26 AWG (7 strand) ribbon cable
- Tape option for high-speed termination, contact Molex for part numbers

Reference Information

Product Specification: PS-99020-0011
 Packaging: Bag (tape optional)
 Tooling Information: See end of section
 UL File No.: E29179
 CSA File No.: LR19980-181
 Mates With: 90325, 90779, 90800, 90814, 91330 and 91714
 Use Molex Cable: 6800, 8863 and 40158
 Designed In: Millimeters

Electrical

Voltage: 250V
 Current: 1.2A
 Contact Resistance: 15 milliohms max.
 Dielectric Withstanding Voltage: 750V rms
 Insulation Resistance: 1000 Megohms min.

Mechanical

Mating Force: Tin—1.7N; Gold—1.1N
 Unmating Force: Tin—0.25N; Gold—0.25N
 Durability: Tin—30 cycles max.
 Gold—100 cycles max. (using extraction tool)

Physical

Housing: White polyester, UL 94V-0
 Contact: Phosphor Bronze Alloy
 Plating: See Table
 Cable Accommodation: 26 and 28 AWG stranded

Circuits	Order No.		Lead-free
	Plating 1	Plating 2	
4	90327-0304	90327-3304	Yes
6	90327-0306	90327-3306	
8	90327-0308	90327-3308	
10	90327-0310	90327-3310	
12	90327-0312	90327-3312	
14	90327-0314	90327-3314	

Plating 1: 2-4µm (80-160µ") Tin
 Plating 2: 0.76µm (30µ") Select Gold

Circuits	Order No.		Lead-free
	Plating 1	Plating 2	
16	90327-0316	90327-3316	Yes
18	90327-0318	90327-3318	
20	90327-0320	90327-3320	
22	90327-0322	90327-3322	
24	90327-0324	90327-3324	
26	90327-0326	90327-3326	

1.27mm (.050") Pitch Picoflex™ PF-50 Connector

90584
Low Profile, IDT
Board-In

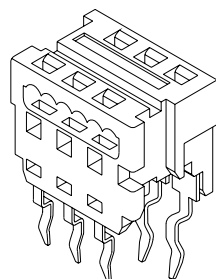

Features and Benefits

- For permanent wire-to-board connections
- Kinked solder tails for board retention during solder process
- Fits same board layout pattern as male header
- Height from board when soldered and terminated only 6.40mm (.252")
- 2 points of contact in IDT section
- Accepts 26 to 28 AWG, 7 strands, ribbon cable

Reference Information

Product Specification: PS-99020-0011
 Packaging: Tube (2 options)
 Tooling Information: See end of section
 Designed In: Millimeters

Electrical

Voltage: 250V
 Current: 1.2A
 Contact Resistance: 15 milliohms max.
 Dielectric Withstanding Voltage: 750V
 Insulation Resistance: 1000 Megohms min.

Physical

Housing: White polyester, UL 94V-0
 Contact: Phosphor Bronze Alloy
 Plating: 2-4µm (80-160µ") Tin over Nickel

Circuits	Order No.		Lead-free
	Individual Tube	Stacked Tube	
4	90584-1304	90584-2304	Yes
6	90584-1306	90584-2306	
8	90584-1308	90584-2308	
10	90584-1310	90584-2310	
12	90584-1312	90584-2312	
14	90584-1314	90584-2314	

Note: Stacked tube is a group of 7 individual tubes in a stack

Circuits	Order No.		Lead-free
	Individual Tube	Stacked Tube	
16	90584-1316	90584-2316	Yes
18	90584-1318	90584-2318	
20	90584-1320	90584-2320	
22	90584-1322	90584-2322	
24	90584-1324	90584-2324	
26	90584-1326	90584-2326	

1.27mm (.050") Pitch Picoflex™ PF-50 Crimp Terminal

91821

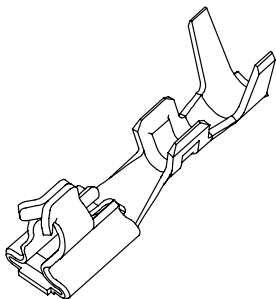

Order No.		Lead-free
Tin	Gold	
91821-0001	91821-0003	Yes

Features and Benefits

- High current capability
- Two points of contact with male pin
- Can be used in low current/high temperature/high vibration applications

Reference Information

Product Specification: PS-99020-0011
 Packaging: Reel
 Mates With: 90814, 90325, 90779, 90800, 91714 and 91330
 Use With: 91935
 Designed In: Millimeters

Electrical

Voltage: 250V
 Current: 2.4A
 Contact Resistance: 15 milliohms max.
 Dielectric Withstanding Voltage: 750V rms
 Insulation Resistance: 1000 Megohms min.

Mechanical

Contact Insertion Force: 1.7N
 Contact Retention to Housing: 15N
 Wire Pull-Out Force: 10 to 30N
 Durability: 30 cycles min.

Physical

Contact: Phosphor Bronze
 Plating: Contact Area—Tin/Gold
 Underplating—Nickel
 Insulation Diameter: 1.50mm max.
 Strip Length: 2.00 to 2.50mm
 Wire Gauge: 24 to 28AWG

1.27mm (.050") Pitch Picoflex™ PF-50 Crimp Housing

91935

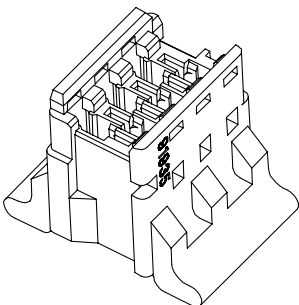

Circuits	Order No.	Lead-free
4	91935-9004	Yes
6	91935-9006	
8	91935-9008	
10	91935-9010	
12	91935-9012	
14	91935-9014	

Features and Benefits

- Glow wire compatible 750°C
- Termination windows for visual check on crimp termination
- Friction lock
- Polarized housing
- Finger grips for ease of use

Reference Information

Product Specification: PS-99020-0011
 Packaging: Bag
 Mates With: 90814, 90325, 90779, 90800, 91714 and 91330
 Use With: 91821
 Designed In: Millimeters

Electrical

Voltage: 250V
 Current: 2.4A
 Contact Resistance: 15 milliohms max.
 Dielectric Withstanding Voltage: 750V rms
 Insulation Resistance: 1000 Megohms min.

Mechanical

Contact Insertion Force: 1.7N
 Contact Retention to Housing: 15N
 Durability: 30 cycles min.

Physical

Housing: Natural 30% glass-filled PET, UL 94V-0

Circuits	Order No.	Lead-free
16	91935-9016	Yes
18	91935-9018	
20	91935-9020	
22	91935-9022	
24	91935-9024	
26	91935-9026	

1.27mm (.050") Pitch Picoflex™ PF-50 Header

90325
Low Profile

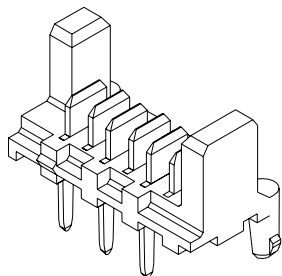

Features and Benefits

- Polarizing side posts and PCB pegs
- Stamped contacts with in-line, flat blades
- 2 points of contact with female terminal
- Rigid, staggered solder tails
- Friction lock
- Tube option packaging for robotic delivery, contact Molex for part numbers

Reference Information

Product Specification: PS-99020-0011
Packaging: Bag or tube
UL File No.: E29179
CSA File No.: LR19980-181
Mates With: 90327 and 91935
Designed In: Millimeters

Electrical

Voltage: 250V
Current: 1.2A
Contact Resistance: 15 milliohms max.
Dielectric Withstanding Voltage: 750V rms
Insulation Resistance: 1000 Megohms min.

Mechanical

Contact Retention to Housing: 7N
Mating Force: Tin—1.7N; Gold—1.1N
Unmating Force: Tin—0.25N; Gold—0.25N
Durability: Tin—30 cycles max.
Gold—100 cycles max. (using extraction tool)

Physical

Housing: Black 15% glass-filled polyester, UL 94V-0
Contact: Brass
Plating: See Table

Circuits	Order No.		Lead-free
	Plating 1	Plating 2	
4	90325-0004	90325-3004	Yes
6	90325-0006	90325-3006	
8	90325-0008	90325-3008	
10	90325-0010	90325-3010	
12	90325-0012	90325-3012	
14	90325-0014	90325-3014	
16	90325-0016	90325-3016	

Plating 1: 3-5µm (120-200µ") Tin
Plating 2: 0.76µm (30µ") Select Gold

Circuits	Order No.		Lead-free
	Plating 1	Plating 2	
14	90325-0014	90325-3014	Yes
16	90325-0016	90325-3016	
18	90325-0018	90325-3018	
20	90325-0020	90325-3020	
22	90325-0022	90325-3022	
24	90325-0024	90325-3024	
26	90325-0026	90325-3026	

1.27mm (.050") Pitch Picoflex™ PF-50 Header

90814
SMT

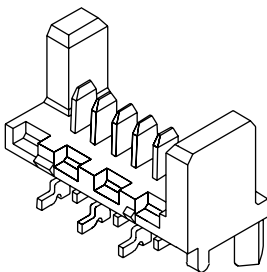

Features and Benefits

- Polarizing side posts and PCB pegs
- Stamped SMT contacts with in-line, flat blades
- 2 points of contact with female terminal
- Rigid, staggered SMT solder tails
- Friction lock

Reference Information

Product Specification: PS-99020-0011
Packaging: Tube or blister pack (contact Molex)
Mates With: 90327 and 91935
Designed In: Millimeters

Electrical

Voltage: 250V
Current: 1.2A
Contact Resistance: 15 milliohms max.
Dielectric Withstanding Voltage: 750V rms
Insulation Resistance: 1000 Megohms min.

Mechanical

Contact Retention to Housing: 7N
Mating Force: Tin—1.7N; Gold—1.1N
Unmating Force: Tin—0.25N; Gold—0.25N
Durability: Tin—30 cycles max.
Gold—100 cycles max. (using extraction tool)

Physical

Housing: Natural 30% glass-filled nylon, UL 94V-0
Contact: Brass
Plating: See Table

Circuits	Order No.				Lead-free
	Tube Pack		Blister Pack		
	120-200µ" (3-5µm) Tin	30µ" (0.76µm) Select Gold	120-200µ" (3-5µm) Tin	30µ" (0.76µm) Select Gold	
4	90814-0804	90814-3804	90814-0904	90814-3904	Yes
6	90814-0806	90814-3806	90814-0906	90814-3906	
8	90814-0808	90814-3808	90814-0908	90814-3908	
10	90814-0810	90814-3810	90814-0910	90814-3910	
12	90814-0812	90814-3812	90814-0912	90814-3912	
14	90814-0814	90814-3814	90814-0914	90814-3914	
16	90814-0816	90814-3816	90814-0916	90814-3916	
18	90814-0818	90814-3818	90814-0918	90814-3918	
20	90814-0820	90814-3820	90814-0920	90814-3920	
22	90814-0822	90814-3822	90814-0922	90814-3922	
24	90814-0824	90814-3824	90814-0924	90814-3924	
26	90814-0826	90814-3826	90814-0926	90814-3926	

1.27mm (.050") Pitch Picoflex™ PF-50 Header

91330
Low Profile, Bottom Entry
SMT

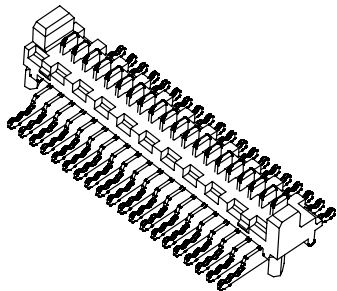

Features and Benefits

- Polarizing side posts and PCB pegs
- Stamped SMT contacts
- Two points of contact with female terminal
- Friction lock
- Can be used in RoHS lead-free process up to 260°C
- Kapton tape for pick and place during SMT assembly
- Low profile application which creates a double-sided board effect with a single-side SMT process

Reference Information

Product Specification: PS-99020-0011
Packaging: Tape and Reel
Mates With: 90327 and 91935
Designed In: Millimeters

Electrical

Voltage: 250V
Current: 1.2 to 2.4A
Contact Resistance: 15 milliohms max.
Dielectric Withstanding Voltage: 750V rms
Insulation Resistance: 1000 Megohms min.

Mechanical

Contact Insertion Force: 1.7N
Contact Retention to Housing: 7N
Durability: 30 cycles max.

Physical

Housing: Natural 30% glass-filled Nylon, UL 94V-0
Contact: Brass
Plating: Contact Area—Tin
Solder Tail Area—Tin
Underplating—Tin
PCB Thickness: 1.57mm ±0.13

Circuits	Order No.	Lead-free
6	91330-0006	Yes
8	91330-0008	
10	91330-0010	
12	91330-0012	
14	91330-0014	
16	91330-0016	

Circuits	Order No.	Lead-free
18	91330-0018	Yes
20	91330-0020	
22	91330-0022	
24	91330-0024	
26	91330-0026	

1.27mm (.050") Pitch Picoflex™ PF-50 Header

90779
Low Profile
High Temperature

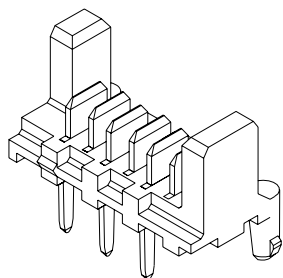

Features and Benefits

- Polarizing side posts and PCB pegs
- Stamped contacts with in-line, flat blades
- 2 points of contact with female terminal
- Rigid, staggered solder tails
- Friction Lock
- High-temperature Surface Mount Compatible housing

Reference Information

Product Specification: PS-99020-0011
Packaging: Bag (contact Molex for tube part numbers)
Mates With: 90327 and 91935
Designed In: Millimeters

Electrical

Voltage: 250V
Current: 1.2A
Contact Resistance: 15 milliohms max.
Dielectric Withstanding Voltage: 750V rms
Insulation Resistance: 1000 Megohms min.

Mechanical

Contact Retention to Housing: 7N
Mating Force: Tin—1.7N; Gold—1.1N
Unmating Force: Tin—0.25N; Gold—0.25N
Durability: Tin—30 cycles max.
Gold—100 cycles max. (using extraction tool)

Physical

Housing: Natural 30% glass-filled nylon, UL 94V-0
Contact: Brass
Plating: See Table

Circuits	Order No.		Lead-free
	Plating 1	Plating 2	
4	90779-0001	90779-3001	Yes
6	90779-0002	90779-3002	
8	90779-0003	90779-3003	
10	90779-0004	90779-3004	
12	90779-0005	90779-3005	
14	90779-0006	90779-3006	

Plating 1: Tin 4-6µm (160-240µ")
Plating 2: Select Gold .76µm (30µ")

Circuits	Order No.		Lead-free
	Plating 1	Plating 2	
16	90779-0007	90779-3007	Yes
18	90779-0008	90779-3008	
20	90779-0010	90779-3010	
22	90779-0011	90779-3011	
24	90779-0012	90779-3012	
26	90779-0013	90779-3013	

1.27mm (.050") Pitch Picoflex™ PF-50 Header

90800
Right Angle, Low Profile

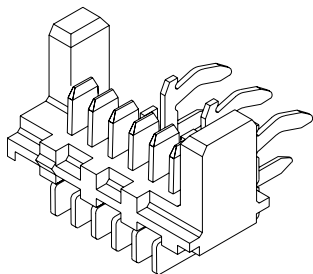

Features and Benefits

- Polarizing side posts
- Stamped contacts
- 2 points of contact with female terminal
- Kinked solder tails for board retention during solder process
- Friction lock

Reference Information

Packaging: Tube
Tooling Information: See end of section
Mates With: 90327
Designed In: Millimeters

Electrical

Voltage: 250V
Current: 1.2A
Contact Resistance: 15 milliohms max.
Dielectric Withstanding Voltage: 750V
Insulation Resistance: 1000 Megohms min.

Mechanical

Contact Retention to Housing: 7N
Mating Force: Tin—1.7N
Unmating Force: Tin—0.25N
Durability: Tin—30 cycles max. (using extraction tool)

Physical

Housing: Black 15% glass-filled polyester, UL 94V-0
Contact: Brass
Plating: See Table

Circuits	Order No.		Lead-free
	Plating 1	Plating 2	
4	90800-0004	90800-3004	Yes
6	90800-0006	90800-3006	
8	90800-0008		
10	90800-0010		
12	90800-0012	90800-3012	
14	90800-0014	90800-3014	

Plating 1: Tin 3-5µm Tin over Nickel
Plating 2: Select Gold .76µm (30µ")

Circuits	Order No.		Lead-free
	Plating 1	Plating 2	
16	90800-0016		Yes
18	90800-0018		
20	90800-0020	90800-3020	
22	90800-0022		
24	90800-0024	90800-3024	
26	90800-0026	90800-3026	

1.27mm (.050") Pitch Picoflex™ PF-50 Header

91714
Right Angle, Low Profile
High Temperature
Through Hole

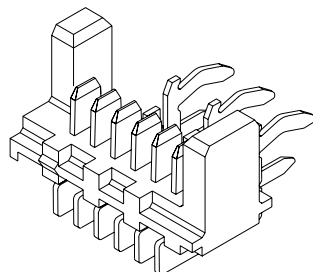

Features and Benefits

- Polarizing side posts
- Stamped contacts
- Two points of contact with female terminal
- Kinked solder tails for board retention during solder process
- Friction lock
- High-temperature Surface Mount Compatible housing

Reference Information

Product Specification: PS-99020-0011
Packaging: Tube
Mates With: 90327 and 91935
Designed In: Millimeters

Electrical

Voltage: 250V
Current: 1.2 to 2.4A
Contact Resistance: 15 milliohms max.
Dielectric Withstanding Voltage: 750V rms
Insulation Resistance: 1000 Megohms min.

Mechanical

Contact Insertion Force: 1.7N
Contact Retention to Housing: 7N
Durability: 30 cycles min.

Physical

Housing: Natural 30% glass-filled Nylon, UL 94V-0
Contact: Brass
Plating: Contact Area—Tin/Gold
Solder Tail Area—Tin
Underplating—Nickel
PCB Thickness: 1.60mm ±0.20

Circuits	Order No.		Lead-free
	Tin	Gold	
4	91714-0004	91714-3004	Yes
6	91714-0006	91714-3006	
8	91714-0008	91714-3008	
10	91714-0010	91714-3010	
12	91714-0012	91714-3012	
14	91714-0014	91714-3014	

Circuits	Order No.		Lead-free
	Tin	Gold	
16	91714-0016	91714-3016	Yes
18	91714-0018	91714-3018	
20	91714-0020	91714-3020	
22	91714-0022	91714-3022	
24	91714-0024	91714-3024	
26	91714-0026	91714-3026	

1.27mm (.050") Pitch Picoflex™ PF-50 Latched Header

90816
SMT

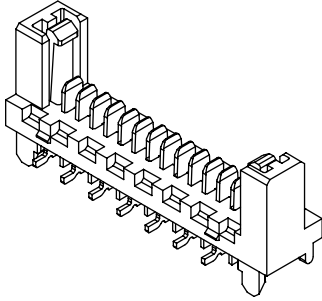

Features and Benefits

- Positive latch for increased retention
- Polarizing side posts and PCB pegs
- Stamped SMT contacts with in-line, flat blades
- 2 points of contact with female terminal
- Rigid, staggered SMT solder tails
- Can be used in RMS lead-free process up to 260°

Reference Information

Product Specification: PS-99020-0011
Packaging: Tube or blister pack (contact Molex)
Mates With: 90327
Designed In: Millimeters

Electrical

Voltage: 250V
Current: 1.2A
Contact Resistance: 15 milliohms max.
Dielectric Withstanding Voltage: 750V rms
Insulation Resistance: 1000 Megohms min.

Mechanical

Contact Retention to Housing: 7N
Mating Force: Tin—1.7N; Gold—1.1N
Unmating Force: Tin—0.25N; Gold—0.25N
Durability: Tin—5 cycles max. (using extraction tool)
Gold—5 cycles max. (using extraction tool)

Physical

Housing: Black Polyphthalamide 30% glass-filled
Contact: Brass
Plating: See Table

Circuits	Order No.				Lead-free
	Tube Pack		Blister Pack		
	120-200 μ m (3-5 μ m) Tin	30 μ m (0.76 μ m) Select Gold	120-200 μ m (3-5 μ m) Tin	30 μ m (0.76 μ m) Select Gold	
4	90816-0004	90816-3004			Yes
6	90816-0006	90816-3006	90816-0206	90816-3206	
8	90816-0008	90816-3008	90816-0208	90816-3208	
10	90816-0010	90816-3010	90816-0210	90816-3210	
12	90816-0012	90816-3012	90816-0212	90816-3212	
14	90816-0014	90816-3014	90816-0214	90816-3214	
16	90816-0016	90816-3016	90816-0216	90816-3216	
18	90816-0018	90816-3018	90816-0218	90816-3218	
20	90816-0020	90816-3020	90816-0220	90816-3220	
22	90816-0022	90816-3022	90816-0222	90816-3222	
24	90816-0024	90816-3024	90816-0224	90816-3224	
26	90816-0026	90816-3026	90816-0226	90816-3226	

1.27mm (.050") Pitch Picoflex™ PF-50 Custom Cable Harness

92315

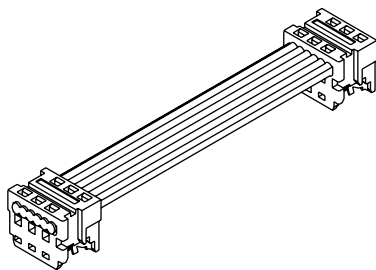

Features and Benefits

- Cable assembly with two 90327 connectors, C-style
- Sizes 4 to 26
- UL 2651, 28 AWG (7 strand) ribbon cable
- Lengths from 6 to 120cm

Reference Information

Packaging: Bag
Mates With: 90325, 90800, 90814, 90715 and 90779
Designed In: Millimeters

Electrical

Voltage: 250V
Current: 1.2A

Mechanical

Mating Force: 1.7N
Unmating Force: 0.25N
Durability: 30 cycles max.

Physical

Housing: 6/6 nylon, UL 94V-0
Contact: Phosphor Bronze Alloy
Plating: 3 to 6 μ Tin
Insulation: Cable—Gray PVC
Wire Range: 28 AWG

Circuits	Order No.	Lead-free
4	92315-04XX	Yes
6	92315-06XX	
8	92315-08XX	
10	92315-10XX	
12	92315-12XX	
14	92315-14XX	

Circuits	Order No.	Lead-free
16	92315-16XX	Yes
18	92315-18XX	
20	92315-20XX	
22	92315-22XX	
24	92315-24XX	
26	92315-26XX	

Length	XX
6-99cm	06-99
100cm	01
105cm	02
110cm	03
115cm	04
120cm	05

Replace XX with length in cm (min. 6cm, max. 120cm), see table
Example: 92315-0832 is a cable with two 90327-0308, 32cm long

1.27mm (.050") Pitch Picoflex™ PF-50 Custom Cable Harness

92317

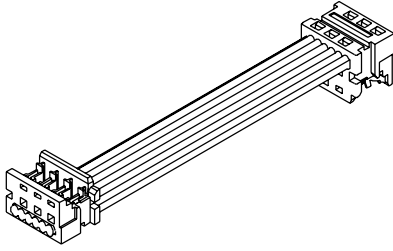

Features and Benefits

- Cable assembly with two 90327 connectors, Z-style
- Sizes 4 to 26
- UL 2651, 28 AWG (7 strand) ribbon cable
- Lengths from 6 to 120cm

Reference Information

Packaging: Bag
Mates With: 90325, 90800, 90814, 90715 and 90779
Designed In: Millimeters

Electrical

Voltage: 250V
Current: 1.2A

Mechanical

Mating Force: 1.7N
Unmating Force: 0.25N
Durability: 30 cycles max.

Physical

Housing: 6/6 nylon, UL 94V-0
Contact: Phosphor Bronze Alloy
Plating: 3 to 6µ" Tin
Insulation: Cable—Gray PVC
Wire Range: 28 AWG

G

Ribbon Cable Connectors, Wire Traps, Cable Holders

Circuits	Order No.	Lead-free
4	92317-04XX	Yes
6	92317-06XX	
8	92317-08XX	
10	92317-10XX	
12	92317-12XX	
14	92317-14XX	

Circuits	Order No.	Lead-free
16	92317-16XX	Yes
18	92317-18XX	
20	92317-20XX	
22	92317-22XX	
24	92317-24XX	
26	92317-26XX	

Length	XX
6-99cm	06-99
100cm	01
105cm	02
110cm	03
115cm	04
120cm	05

Replace XX with length in cm (min. 6cm, max. 120cm), see table
Example: 92317-0832 is a cable with two 90327-0308, 32cm long

1.27mm (.050") Pitch Picoflex™ PF-50 Custom Cable Harness

92318

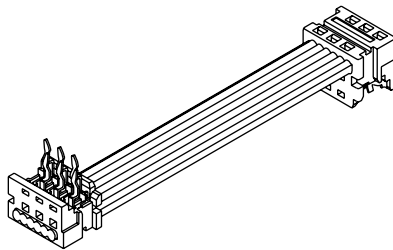

Features and Benefits

- Cable assembly with 90327 and 90584 connectors, Z-style
- Sizes 4 to 26
- UL 2651, 28 AWG (7 strand) ribbon cable
- Lengths from 6 to 120cm

Reference Information

Packaging: Tube
Mates With: 90325, 90800, 90814, 90715 and 90779
Designed In: Millimeters

Electrical

Voltage: 250V
Current: 1.2A

Mechanical

Mating Force: 1.7N
Unmating Force: 0.25N
Durability: 30 cycles max.

Physical

Housing: 6/6 nylon, UL 94V-0
Contact: Phosphor Bronze Alloy
Plating: 3 to 6µ" Tin
Insulation: Cable—Gray PVC
Wire Range: 28 AWG

Circuits	Order No.	Lead-free
4	92318-04XX	Yes
6	92318-06XX	
8	92318-08XX	
10	92318-10XX	
12	92318-12XX	
14	92318-14XX	

Circuits	Order No.	Lead-free
16	92318-16XX	Yes
18	92318-18XX	
20	92318-20XX	
22	92318-22XX	
24	92318-24XX	
26	92318-26XX	

Length	XX
6-99cm	06-99
100cm	01
105cm	02
110cm	03
115cm	04
120cm	05

Replace XX with length in cm (min. 6cm, max. 120cm), see table
Example: 92318-0832 is a cable with 90327-0308 and 90584-2308, 32cm long

1.27mm (.050") Pitch Picoflex™ PF-50 Custom Cable Harness

92316

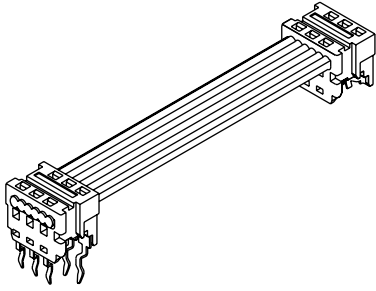

Features and Benefits

- Cable assembly with 90327 and 90584 connectors, C-style
- Sizes 4 to 26
- UL 2651, 28 AWG (7 strand) ribbon cable
- Lengths from 6 to 120cm

Reference Information

Packaging: Tube
Mates With: 90325, 90800, 90814, 90715 and 90779
Designed In: Millimeters

Electrical

Voltage: 250V
Current: 1.2A

Mechanical

Mating Force: 1.7N
Unmating Force: 0.25N
Durability: 30 cycles max.

Physical

Housing: 6/6 nylon, UL 94V-0
Contact: Phosphor Bronze Alloy
Plating: 3 to 6µ" Tin
Insulation: Cable—Gray PVC
Wire Range: 28 AWG

Circuits	Order No.	Lead-free
4	92316-04XX	Yes
6	92316-06XX	
8	92316-08XX	
10	92316-10XX	
12	92316-12XX	
14	92316-14XX	

Circuits	Order No.	Lead-free
16	92316-16XX	Yes
18	92316-18XX	
20	92316-20XX	
22	92316-22XX	
24	92316-24XX	
26	92316-26XX	

Length	XX
6-99cm	06-99
100cm	01
105cm	02
110cm	03
115cm	04
120cm	05

Replace XX with length in cm (min. 6 cm, max. 120cm), see table
Example: 92316-0832 is a cable with 90327-0308 and 90584-2308, 32cm long



2.54mm (.100") Pitch QF-50™ Connector System For 1.27mm (.050") Pitch Ribbon Cable

Molex offers one of the widest ranges of connectors for 1.27mm (.050") ribbon cable on the market today. The QF-50 family features a variety of products conforming to industry-standard styles, such as DIN 41651, MIL-C-83503 keying, HE-10, etc. There is a choice of receptacle styles addressed to specific market requirements and a variety of designer-friendly headers.

Receptacles

Built to the highest-quality standards, 2 distinct styles are offered:

- 5320 series, incorporating a dual-contact beam independently acknowledged to out-perform others on the market
- 90635 series, a lower-cost single-contact beam product, offering all the technical performance of its dual-beam counterpart, while also offering MIL keying

Headers

Available in 3 styles:

- Latch-eject style uniquely functioning with or without strain reliefs on receptacles and with ejectors that remain flush with the body, thus saving valuable PCB real estate
- Standard shrouded headers
- Low-profile headers in industry-standard styles with various options, including variable board location/retention features and SMT-compatible insulators

Application Tooling

Molex has developed a choice of equipment that allows you to tailor your application tooling according to your volumes—from simple hand tools to high-volume automatic termination. Various packaging styles are available as options to optimize your applied cost. Please see end of section.

Cable

In line with the philosophy of offering our customers a complete interconnection solution, Molex also supplies the necessary cable to get you connected! Please refer to section H.

Ribbon Cable Connectors, Wire Traps, Cable Holders

G

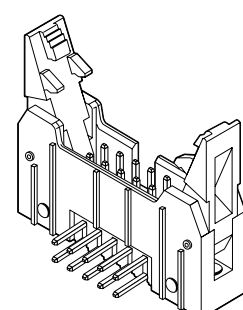
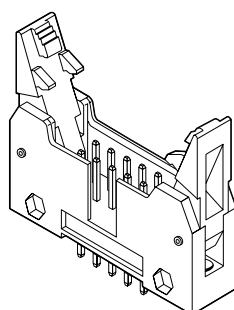
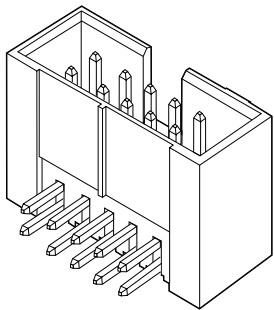
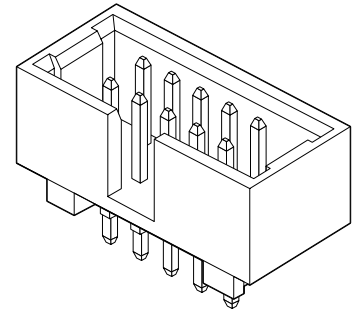
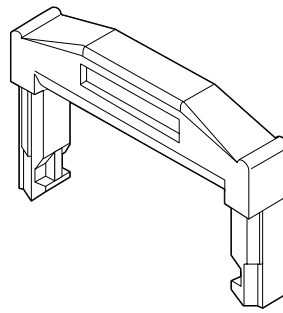
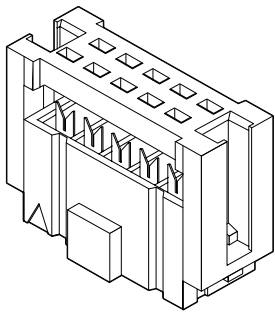

2.54mm (.100") Pitch QF-50™ Receptacle

5320-NA Dual Row Unloaded Upper Housing

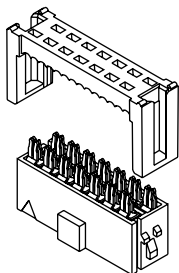

Features and Benefits

- Sizes 10 to 64 circuits
- For 1.27mm (.050") ribbon cable
- Single polarization

Reference Information

Packaging: Tray
 Tooling Information: See section U
 UL File No.: E29179
 CSA File No.: LR19980
 Mates With: 5330, 5332, 5340, 5342, 5576 and 5578
 Use With: 90170 strain relief
 Designed In: Millimeters

Electrical

Current: 1.0A
 Contact Resistance: 20 milliohms max.
 Dielectric Withstanding Voltage: 500V AC
 Insulation Resistance: 1000 Megohms min.

Physical

Housing: Black glass-filled polyester, UL 94V-0
 Contact: Phosphor Bronze Alloy
 Plating: See Table
 Cable Accommodation: 26 AWG stranded and 28 AWG
 stranded and solid
 Insulation Range: 1.14mm (.045") diameter max.

Circuits	Order No.		Lead-free
	4µ" (0.1µm) Gold	35µ" (0.9µm) Tin	
10	39-53-4106	39-52-1104	Yes
14	39-53-4146	39-52-1144	
16	39-53-4166	39-52-1164	
20	39-53-4206	39-52-1204	
26	39-53-4266	39-52-1264	
30	39-53-4306	39-52-1304	

Circuits	Order No.		Lead-free
	4µ" (0.1µm) Gold	35µ" (0.9µm) Tin	
34	39-53-4346	39-52-1344	Yes
40	39-53-4406	39-52-1404	
50	39-53-4506	39-52-1504	
60	39-53-4606		
64	39-53-4646		

2.54mm (.100) Pitch QF-50™ Receptacle

5320-NB Dual Row Preloaded Upper Housing

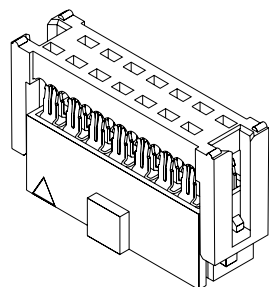

Features and Benefits

- Sizes 10 to 64 circuits
- For 1.27mm (.050") ribbon cable
- Single polarization

Reference Information

Packaging: Tray
 UL File No.: E29179
 CSA File No.: LR37272-P21
 Mates With: 5330, 5332, 5340, 5342, 5576
 and 5578
 Use With: 90170 strain relief
 Designed In: Millimeters

Electrical

Current: 1.0A
 Contact Resistance: 20 milliohms max.
 Dielectric Withstanding Voltage: 500V AC
 Insulation Resistance: 1000 Megohms min.

Physical

Housing: Black glass-filled polyester, UL 94V-0
 Contact: Phosphor Bronze Alloy
 Plating: See Table
 Cable Accommodation: 26 AWG stranded and 28 AWG
 stranded and solid
 Insulation Range: 1.14mm (.045") diameter max.

Circuits	Order No.			Lead-free
	4µ" (0.1µm) Gold	30µ" (0.76µm) Gold	35µ" (0.9µm) Tin	
10	39-53-3109	39-53-4100	39-52-1105	Yes
14	39-53-3149	39-53-4140	39-52-1145	
16	39-53-3169	39-53-4160	39-52-1165	
20	39-53-3209	39-53-4200	39-52-1205	
26	39-53-3269	39-53-4260	39-52-1265	
30	39-53-3309	39-53-4300	39-52-1305	

Circuits	Order No.			Lead-free
	4µ" (0.1µm) Gold	30µ" (0.76µm) Gold	35µ" (0.9µm) Tin	
34	39-53-3349	39-53-4340	39-52-1345	Yes
40	39-53-3409	39-53-4400	39-52-1405	
50	39-53-3509	39-53-4500	39-52-1505	
60	39-53-3609	39-53-4600		
64	39-53-3649	39-53-4640		

1.27mm (.050") Pitch QF-50™ Receptacle

90635
Vertical, MIL/DIN Version

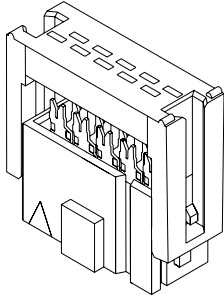

Features and Benefits

- Sizes 10 to 64 circuits
- Available with or without polarization
- Complies with industry-standard DIN 41651 and MIL-3-83503 keying
- Selective Gold plating option for contacts
- Available in various packaging styles

Reference Information

Product Specification: PS-99020-0015
Packaging: Tray (contact Molex for chain)
Tooling Information: See end of section
Mates With: 90663
Use With: 90170 strain relief
Designed In: Millimeters

Electrical

Voltage: 250V
Current: 1.0A
Contact Resistance: 20 milliohms max.
Dielectric Withstanding Voltage: 500V AC
Insulation Resistance: 1000 Megohms min.

Mechanical

Mating Force: 350g (0.77 lb) max. per circuit
Unmating Force: 50g (0.11 lb) min. per circuit
Durability: 300 cycles max.

Physical

Housing: Glass-filled polyester, UL 94V-0
Contact: Copper Alloy
Plating: See Table
Cable Accommodation: 26 AWG stranded and 28 AWG stranded and solid

Circuits	Order No.						Lead-free
	With Polarization			Without Polarization			
	Plating 1	Plating 2	Plating 3	Plating 1	Plating 2	Plating 3	
10	90635-1101	90635-1102	90635-1103	90635-3101	90635-3102	90635-3103	Yes
14	90635-1141	90635-1142	90635-1143	90635-3141	90635-3142	90635-3143	
16	90635-1161	90635-1162	90635-1163	90635-3161	90635-3162	90635-3163	
20	90635-1201	90635-1202	90635-1203	90635-3201	90635-3202	90635-3203	
24	90635-1241	90635-1242	90635-1243	90635-3241	90635-3242	90635-3243	
26	90635-1261	90635-1262	90635-1263	90635-3261	90635-3262	90635-3263	
30	90635-1301	90635-1302	90635-1303	90635-3301	90635-3302	90635-3303	
34	90635-1341	90635-1342	90635-1343	90635-3341	90635-3342	90635-3343	
40	90635-1401	90635-1402	90635-1403	90635-3401	90635-3402	90635-3403	
50	90635-1501	90635-1502	90635-1503	90635-3501	90635-3502	90635-3503	
60	90635-1601	90635-1602	90635-1603	90635-3601	90635-3602	90635-3603	
64	90635-1641	90635-1642	90635-1643	90635-3641	90635-3642	90635-3643	

Plating 1: Contact area: 4µ" Gold flash min. IDT area: 39µ" min. Tin over Nickel.
Plating 2: Contact area: 30µ" Gold min. IDT area: 39µ" min. Tin over Nickel.
Plating 3: Contact area: 15µ" Gold min. IDT area: 39µ" Tin over Nickel.

QF-50™ Strain Relief

90170
DIN 41651, Standard
Low Profile

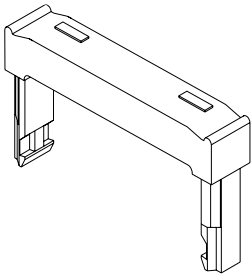

Features and Benefits

- Complies with industry-standard DIN 41651

Reference Information

Product Specification: PS-99020-0015
Packaging: Bag
Use With: 5320 and 90635
Designed In: Inches

Physical

Housing: Black glass-filled polyester, UL 94V-0

Preferred Version in Europe

Circuits*	Order No.
10	90170-0010
14	90170-0014
16	90170-0016
20	90170-0020
26	90170-0026
30	90170-0030

Circuits*	Order No.
34	90170-0034
40	90170-0040
50	90170-0050
60	90170-0060
64	90170-0064

* Number of circuits on mating connector

2.54mm (.100") Pitch QF-50™ Shrouded Header 5332 Vertical, Dual Row Single Polarization

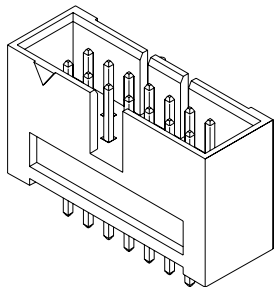

Features and Benefits

- Sizes 10 to 60 circuits
- Selective Gold- and Tin-plated versions

Reference Information

Packaging: Tray
UL File No.: E29179-E
Mates With: 5320-NA and 5320-NB
Designed In: Millimeters

Electrical

Current: 1.0A
Contact Resistance: 20 milliohms max.
Dielectric Withstanding Voltage: 500V AC
Insulation Resistance: 1000 Megohms min.

Physical

Housing: Black glass-filled polyester, UL 94V-0
Contact: Brass
Contact Pin: 0.635mm (.025") square
Plating: See Table

Circuits	Order No.			Lead-free
	4μ" (0.1μm) Gold	30μ" (0.76μm) Gold	35μ" (0.9μm) Tin	
10	39-53-6104	39-53-6105	39-28-5101	Yes
14	39-53-6144	39-53-6145	39-28-5141	
16	39-53-6164	39-53-6165	39-28-5161	
20	39-53-6204	39-53-6205	39-28-5201	
26	39-53-6264	39-53-6265	39-28-5261	

Circuits	Order No.			Lead-free
	4μ" (0.1μm) Gold	30μ" (0.76μm) Gold	35μ" (0.9μm) Tin	
30	39-53-6304	39-53-6305	39-28-5301	Yes
34	39-53-6344	39-53-6345	39-28-5341	
40	39-53-6404	39-53-6405		
50	39-53-6504	39-53-6505		
60	39-53-6604	39-53-6605		

2.54mm (.100") Pitch QF-50™ Shrouded Header 5342 Right Angle, Dual Row Single Polarization

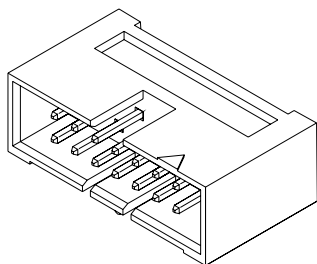

Features and Benefits

- Sizes 10 to 60 circuits
- Selective Gold- and Tin-plated versions

Reference Information

Packaging: Tray
UL File No.: E29179-E
Mates With: 5320-NA and 5320-NB
Designed In: Millimeters

Electrical

Current: 1.0A
Contact Resistance: 20 milliohms max.
Dielectric Withstanding Voltage: 500V AC
Insulation Resistance: 1000 Megohms min.

Physical

Housing: Black glass-filled polyester, UL 94V-0
Contact: Brass
Contact Pin: 0.635mm (.025") square
Plating: See Table

Circuits	Order No.			Lead-free
	4μ" (0.1μm) Gold	30μ" (0.76μm) Gold	35μ" (0.9μm) Tin	
10	39-53-7104	39-53-7105	39-28-5104	Yes
14	39-53-7144	39-53-7145	39-28-5144	
16	39-53-7164	39-53-7165	39-28-5164	
20	39-53-7204	39-53-7205	39-28-5204	
26	39-53-7264	39-53-7265	39-28-5264	

Circuits	Order No.			Lead-free
	4μ" (0.1μm) Gold	30μ" (0.76μm) Gold	35μ" (0.9μm) Tin	
30	39-53-7304	39-53-7305	39-28-5304	Yes
34	39-53-7344	39-53-7345	39-28-5344	
40	39-53-7404	39-53-7405		
50	39-53-7504	39-53-7505		
60	39-53-7604	39-53-7605		

2.54mm (.100") Pitch QF-50™ Shrouded Header

5330
Vertical, Dual Row
With Eject Levers

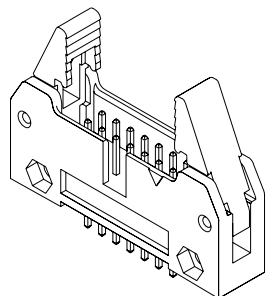

Features and Benefits

- Sizes 10 to 64 circuits
- Polarized
- Stackable side-by-side
- Latches connector with or without strain relief
- Selective Gold- and overall Tin-plated versions
- Lever spring pins—Stainless Steel

Reference Information

Packaging: Tray
UL File No.: E29179-E
CSA File No.: LR19980
Mates With: 5320-NA and 5320-NB
Designed In: Millimeters

Electrical

Current: 1.0A
Contact Resistance: 20 milliohms max.
Dielectric Withstanding Voltage: 500V AC
Insulation Resistance: 1000 Megohms min.

Physical

Housing: Black glass-filled polyester, UL 94V-0
Contact: Brass
Contact Pins: 0.635mm (.025") square
Plating: See Table

Circuits	Order No.			Lead-free
	4μ" (0.1μm) Gold	30μ" (0.76μm) Gold	35μ" (0.9μm) Tin	
10	39-35-2106	39-53-5109	39-28-5100	Yes
14	39-35-2146	39-53-5149	39-28-5140	
16	39-35-2166	39-53-5169	39-28-5160	
20	39-35-2206	39-53-5209	39-28-5200	
26	39-35-2266	39-53-5269	39-28-5260	
30	39-35-2306	39-53-5309	39-28-5300	

Circuits	Order No.			Lead-free
	4μ" (0.1μm) Gold	30μ" (0.76μm) Gold	35μ" (0.9μm) Tin	
34	39-35-2346	39-53-5349	39-28-5340	Yes
40	39-35-2406	39-53-5409	39-28-5400	
50	39-35-2506	39-53-5509	39-28-5500	
60	39-35-2606	39-53-5609		
64	39-35-2646	39-53-5649		

2.54mm (.100") Pitch QF-50™ Shrouded Header

5340
Right Angle, Dual Row
With Eject Levers

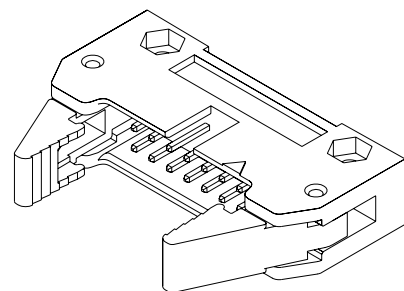

Features and Benefits

- Sizes 10 to 64 circuits
- Polarized
- Stackable side-by-side
- Selective Gold- and overall Tin-plated versions
- Lever spring pins—Stainless Steel

Reference

Packaging: Tray
UL File No.: E29179-E
Mates With: 5320-NA and 5320-NB
Designed In: Millimeters

Electrical

Current: 1.0A
Contact Resistance: 20 milliohms max.
Dielectric Withstanding Voltage: 500V AC
Insulation Resistance: 1000 Megohms min.

Physical

Housing: Black glass-filled polyester, UL 94V-0
Contact: Brass
Contact Pin: 0.635mm (.025") square
Plating: See Table

Circuits	Order No.			Lead-free
	4μ" (0.1μm) Gold	30μ" (0.76μm) Gold	35μ" (0.9μm) Tin	
10	39-53-3107	39-53-7108	39-28-5103	Yes
14	39-53-3147	39-53-7148	39-28-5143	
16	39-53-3167	39-53-7168	39-28-5163	
20	39-53-3207	39-53-7208	39-28-5203	
26	39-53-3267	39-53-7268	39-28-5263	
30	39-53-3307	39-53-7308	39-28-5303	

Circuits	Order No.			Lead-free
	4μ" (0.1μm) Gold	30μ" (0.76μm) Gold	35μ" (0.9μm) Tin	
34	39-53-3347	39-53-7348	39-28-5343	Yes
40	39-53-3407	39-53-7408	39-28-5403	
50	39-53-3507	39-53-7508	39-28-5503	
60	39-53-3607	39-53-7608		
64	39-53-3647	39-53-7648		

2.54mm (.100") Pitch QF-50™ Shrouded Header

5576 Vertical With Eject Levers

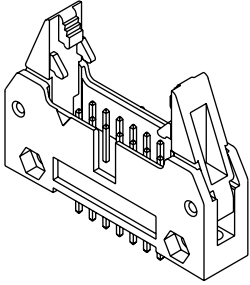

Features and Benefits

- 10 to 64 circuits
- Tin plated on solder tail
- Complies with industry standard DIN 41654
- Polarized
- Selective Gold plating options for contacts
- Eject levers allow end-to-end stacking with or without strain relief with no loss of board space

Reference Information

Packaging: Tray
Designed In: Millimeters
Mates With: 5320

Electrical

Voltage: 250V
Current: 1.0A
Contact Resistance: 20 milliohms max.
Dielectric Withstanding Voltage: 500V
Insulation Resistance: 1000 Megohms min.

Physical

Housing: Glass-filled PBTP
Contact: Brass

Circuits	Order No.			Lead-free
	Plating NBGS1	Plating NBGS2	Plating NBT2	
10	39-27-1103	39-27-1104	39-28-5105	Yes
14	39-27-1143	39-27-1144	39-28-5145	
16	39-27-1163	39-27-1164	39-28-5165	
20	39-27-1203	39-27-1204	39-28-5205	
26	39-27-1263	39-27-1264	39-28-5265	
30	39-27-1303	39-27-1304	39-28-5305	

Plating NBGS1: 39µ" (1µm) min. Nickel underplate. Contact area: 0.1µm min. Gold.
Solder area: 3µm min. Tin

Plating NBGS2: 39µ" (1µm) min. Nickel underplate. Contact area: 0.76µm min. Gold.
Solder area: 3µm min. Tin

Plating NBT2: 20µ" (0.5µm) min. Nickel underplate. Contact and solder area: 39µ" (1µm) min. Tin

Circuits	Order No.			Lead-free
	Plating NBGS1	Plating NBGS2	Plating NBT2	
34	39-27-1343	39-27-1344	39-28-5345	Yes
40	39-27-1403	39-27-1404	39-28-5405	
50	39-27-1503	39-27-1504	39-28-5505	
60	39-27-1603	39-27-1604		
64	39-27-1643	39-27-1644		

2.54mm (.100") Pitch QF-50™ Shrouded Header

5578 Right Angle With Eject Levers

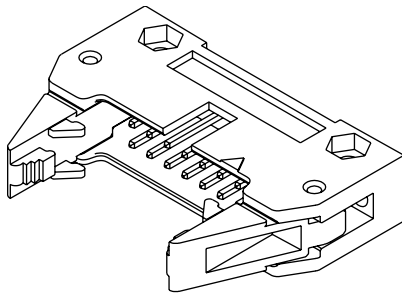

Features and Benefits

- 10 to 64 circuits
- Tin plated on solder tail
- Complies with industry standard DIN 41654
- Polarized
- Selective Gold plating options for contacts
- Eject levers allow end-to-end stacking with or without strain relief with no loss of board space

Reference Information

Packaging: Tray
Mates With: 5320
Designed In: Millimeters

Electrical

Voltage: 250V
Current: 1.0A
Contact Resistance: 20 milliohms max.
Dielectric Withstanding Voltage: 500V
Insulation Resistance: 1000 Megohms min.

Physical

Housing: Glass-filled PBTP
Contact: Brass

Circuits	Order No.			Lead-free
	Plating NBGS17F	Plating NBGS2	Plating NBT2	
10	39-53-6108	39-53-6109	39-28-5106	Yes
14	39-53-6148	39-53-6149	39-28-5146	
16	39-53-6168	39-53-6169	39-28-5166	
20	39-53-6208	39-53-6209	39-28-5206	
26	39-53-6268	39-53-6269	39-28-5266	
30	39-53-6308	39-53-6309	39-28-5306	

Plating NBGS1: 39µ" (1µm) min. Nickel underplate. Contact area: 0.1µm min. Gold.
Solder area: 3µm min. Tin

Plating NBGS2: 39µ" (1µm) min. Nickel underplate. Contact area: 0.76µm min. Gold.
Solder area: 3µm min. Tin

Plating NBT2: 20µ" (0.5µm) min. Nickel underplate. Contact and solder area: 39µ" (1µm) min. Tin

Circuits	Order No.			Lead-free
	Plating NBGS17F	Plating NBGS2	Plating NBT2	
34	39-53-6348	39-53-6349	39-28-5346	Yes
40	39-53-6408	39-53-6409	39-28-5406	
50	39-53-6508	39-53-6509	39-28-5506	
60	39-53-6608	39-53-6609		
64	39-53-6648	39-53-6649		

2.54mm (.100") Pitch QF-50™ Shrouded Header

90663
Vertical, MIL Keying
With Latch/Eject Levers

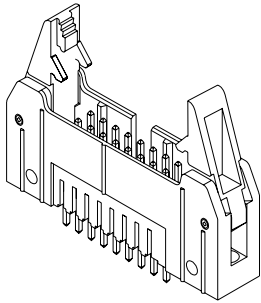

Features and Benefits

- Sizes 10 to 64 circuits
- Tin plated on solder tail
- Complies with industry-standard DIN 41651 and MIL-3-83503 keying
- Selective Gold plating options for contacts
- Eject levers allow end-to-end stacking with or without strain relief with no loss of board space
- Polarized
- Contact Molex for variations on eject levers

Reference Information

Product Specification: PS-99020-0015
Packaging: Tray
Mates With: 90635
Designed In: Millimeters

Electrical

Voltage: 250V
Current: 2.5A
Contact Resistance: 20 milliohms max.
Dielectric Withstanding Voltage: 500V AC
Insulation Resistance: 1000 Megohms min.

Mechanical

Pin Retention Force: 1.5kg (3.3 lb)
Mating Force: 350g (0.77 lb) max. per circuit
Unmating Force: 50g (0.11 lb) min. per circuit
Durability: 300 cycles max.

Physical

Housing: Black glass-filled polyester, UL 94V-0
Contact: Copper Alloy
Plating: See Table

Circuits	Order No.			Lead-free
	Plating 1	Plating 2	Plating 3	
10	90663-1101	90663-1102	90663-1103	Yes
14	90663-1141	90663-1142	90663-1143	
16	90663-1161	90663-1162	90663-1163	
20	90663-1201	90663-1202	90663-1203	
26	90663-1261	90663-1262	90663-1263	
30	90663-1301	90663-1302	90663-1303	

Note: Also available with 91081 ejectors. Please contact Molex.

Plating 1: 4µm Gold in contact area, 118µm Tin in solder area, 39µm Nickel underplate
Plating 2: 30µm Gold in contact area, 118µm Tin in solder area, 39µm Nickel underplate
Plating 3: 10µm Gold in contact area, 118µm Tin in solder area, 39µm Nickel underplate

Circuits	Order No.			Lead-free
	Plating 1	Plating 2	Plating 3	
34	90663-1341	90663-1342	90663-1343	Yes
40	90663-1401	90663-1402	90663-1403	
50	90663-1501	90663-1502	90663-1503	
60	90663-1601	90663-1602	90663-1603	
64	90663-1641	90663-1642	90663-1643	

2.54mm (.100") Pitch QF-50™ Shrouded Header

90663
Right Angle, MIL Keying
With Latch/Eject Levers

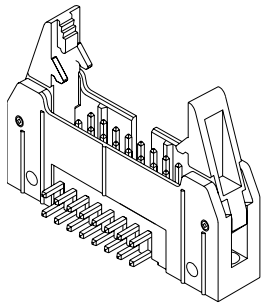

Features and Benefits

- Sizes 10 to 64 circuits
- Tin plated on solder tail
- Complies with industry-standard DIN 41651 and MIL-3 83503 keying
- Selective Gold plating options for contacts
- Eject levers allow end-to-end stacking with or without strain relief with no loss of board space
- Polarized
- Contact Molex for variations on eject levers

Reference Information

Product Specification: PS-99020-0015
Packaging: Tray
Mates With: 90635
Designed In: Millimeters

Electrical

Voltage: 250V
Current: 2.5A
Contact Resistance: 20 milliohms max.
Dielectric Withstanding Voltage: 500V AC
Insulation Resistance: 1000 Megohms min.

Mechanical

Pin Retention Force: 1.5kg (3.3 lb)
Mating Force: 350g (0.77 lb) max. per circuit
Unmating Force: 50g (0.11 lb) min. per circuit
Durability: 300 cycles max.

Physical

Housing: Black glass-filled polyester, UL 94V-0
Contact: Copper Alloy
Plating: See Table

Circuits	Order No.			Lead-free
	Plating 1	Plating 2	Plating 3	
10	90663-3101	90663-3102	90663-3103	Yes
14	90663-3141	90663-3142	90663-3143	
16	90663-3161	90663-3162	90663-3163	
20	90663-3201	90663-3202	90663-3203	
26	90663-3261	90663-3262	90663-3263	
30	90663-3301	90663-3302	90663-3303	

Plating 1: 4µm Gold in contact area, 118µm Tin in solder area, 39µm Nickel underplate
Plating 2: 30µm Gold in contact area, 118µm Tin in solder area, 39µm Nickel underplate
Plating 3: 10µm Gold in contact area, 118µm Tin in solder area, 39µm Nickel underplate

Circuits	Order No.			Lead-free
	Plating 1	Plating 2	Plating 3	
34	90663-3341	90663-3342	90663-3343	Yes
40	90663-3401	90663-3402	90663-3403	
50	90663-3501	90663-3502	90663-3503	
60	90663-3601	90663-3602	90663-3603	
64	90663-3641	90663-3642	90663-3643	

2.54mm (.100") Pitch SL™ Ribbon Cable Connectors

70400/70475 Single Row Cable Connector System

Please refer to section A of this catalog for more detailed information

Features and Benefits

- Sizes 2 to 25 circuits
- Modular connectors for use with SL single row shrouded headers and clips
- Terminals preloaded into housings
- Polarization and positive locking options

Reference Information

Packaging: Tube
 UL File No.: E29179
 CSA File No.: LR19980
 Use Molex Cable: 7307, 7767, 8996, 8997, 24226, 24241, 24369 and 24389
 Designed In: Inches

Electrical

Voltage: 250V
 Current: 3.0A max
 Contact Resistance: 15 milliohms max.
 Dielectric Withstanding Voltage: 1500V
 Insulation Resistance: 10,000 Megohms min.

Mechanical

Contact Insertion Force: 3.11N (0.7 lb) max.
 Contact Retention to Housing: 17.79N (4 lb) min.
 for 15 seconds
 Durability: Tin—25 cycles; Gold—50 cycles

Physical

Housing: Polyester, UL 94V-0
 Contact: Copper alloy

Version D — Male

70475

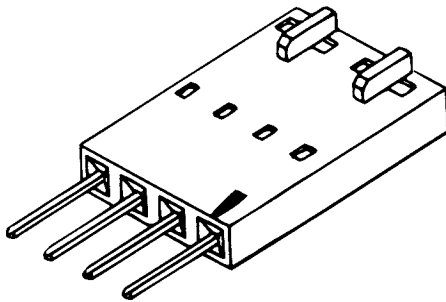

Version A — Female

70400

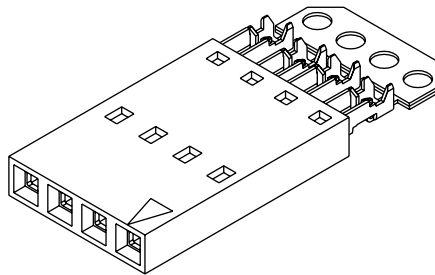

Version C — Female

70400

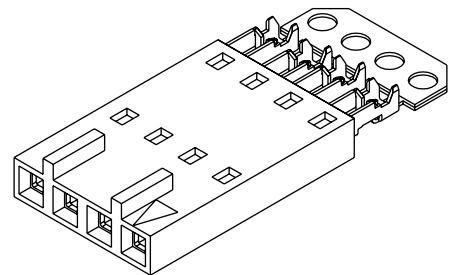

Version D — Female

70400

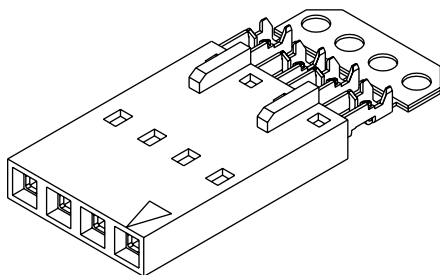

Version G — Female

70400

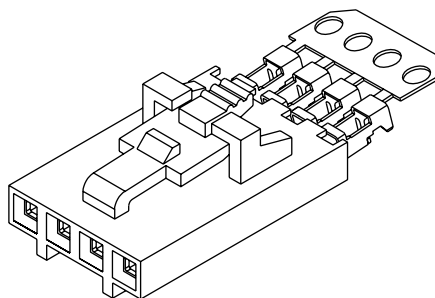

G

Ribbon Cable Connectors, Wire Traps, Cable Holders

2.00mm (.079") Pitch Wire Trap

52147 Pull-Cover Style Vertical

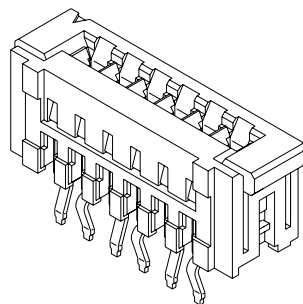

Features and Benefits

- Sizes 2 to 17 circuits
- For topcoated ribbon cable
- Wire range: 26 AWG
- Insulation diameter: 1.60mm max.
- Strip length: 4.50mm

Reference Information

Product Specification: PS-52147-001
 Packaging: Tray
 UL File No.: E29179
 Designed In: Millimeters

Electrical

Voltage: 150V max.
 Current: 2.0A max.
 Contact Resistance: 20 milliohms max.
 Dielectric Withstanding Voltage: 500V AC/1 min.
 Insulation Resistance: 1000 Megohms min.

Physical

Housing: Glass-filled PBT, UL 94V-0
 Actuator: Glass-filled PBT, UL 94V-0
 Contact: Phosphor Bronze
 Plating: Tin

Circuits	Order No.	Lead-free
2	52147-0210	Yes
3	52147-0310	
4	52147-0410	
5	52147-0510	
6	52147-0610	
7	52147-0710	
8	52147-0810	
9	52147-0910	

Circuits	Order No.	Lead-free
10	52147-1010	Yes
11	52147-1110	
12	52147-1210	
13	52147-1310	
14	52147-1410	
15	52147-1510	
16	52147-1610	
17	52147-1710	

Note: All PC tails kinked opposite ways except two-circuit version, which has no kinks

2.00mm (.079") Pitch Wire Trap

52151 Pull-Cover Style Right Angle

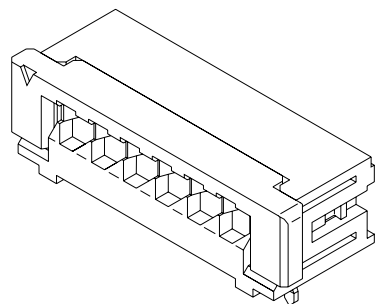

Features and Benefits

- Sizes 2 to 16 circuits
- For topcoated ribbon cable
- Wire range: 26 AWG
- Insulation diameter: 1.60mm max.
- Strip length: 4.50mm

Reference Information

Product Specification: PS-52147-001
 Packaging: Tray
 UL File No.: E29179
 Designed In: Millimeters

Electrical

Voltage: 150V max.
 Current: 2.0A max.
 Contact Resistance: 20 milliohms max.
 Dielectric Withstanding Voltage: 500V AC/1 min.
 Insulation Resistance: 1000 Megohms min.

Physical

Housing: Glass-filled PBT, UL 94V-0
 Actuator: Glass-filled PBT, UL 94V-0
 Contact: Phosphor Bronze
 Plating: Tin

Circuits	Order No.	Lead-free
2	52151-0210	Yes
3	52151-0310	
4	52151-0410	
5	52151-0510	
6	52151-0610	
7	52151-0710	
8	52151-0810	
9	52151-0910	

Circuits	Order No.	Lead-free
10	52151-1010	Yes
11	52151-1110	
12	52151-1210	
13	52151-1310	
14	52151-1410	
15	52151-1510	
16	52151-1610	

Note: All PC tails kinked opposite ways except two-circuit version, which has no kinks