

General Description

The MIC39100, MIC39101, and MIC39102 are 1A low-dropout linear voltage regulators that provide low-voltage, high-current output from an extremely small package. Utilizing Micrel's proprietary Super beta PNP™ pass element, the MIC39100/1/2 offers extremely low dropout (typically 410mV at 1A) and low ground current (typically 11mA at 1A).

The MIC39100 is a fixed output regulator offered in the SOT-223 package. The MIC39101 and MIC39102 are fixed and adjustable regulators, respectively, in a thermally enhanced power 8-lead SOIC package.

The MIC39100/1/2 is ideal for PC add-in cards that need to convert from standard 5V to 3.3V, 3.3V to 2.5V or 2.5V to 1.8V. A guaranteed maximum dropout voltage of 630mV over all operating conditions allows the MIC39100/1/2 to provide 2.5V from a supply as low as 3.13V and 1.8V from a supply as low as 2.43V.

The MIC39100/1/2 is fully protected with overcurrent limiting, thermal shutdown, and reversed-battery protection. Fixed voltages of 5.0V, 3.3V, 2.5V, and 1.8V are available on MIC39100/1 with adjustable output voltages to 1.24V on MIC39102.

For other voltages, contact Micrel.

Features

- Fixed and adjustable output voltages to 1.24V
- 410mV typical dropout at 1A
- **Ideal for 3.0V to 2.5V conversion**
- **Ideal for 2.5V to 1.8V conversion**
- 1A minimum guaranteed output current
- 1% initial accuracy
- Low ground current
- Current limiting and thermal shutdown
- Reversed-battery protection
- Reversed-leakage protection
- Fast transient response
- Low-profile SOT-223 package
- Power SO-8 package

Applications

- LDO linear regulator for PC add-in cards
- PowerPC™ power supplies
- High-efficiency linear power supplies
- SMPS post regulator
- Multimedia and PC processor supplies
- Battery chargers
- Low-voltage microcontrollers and digital logic

Typical Applications

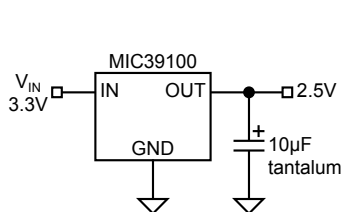

2.5V/1A Regulator

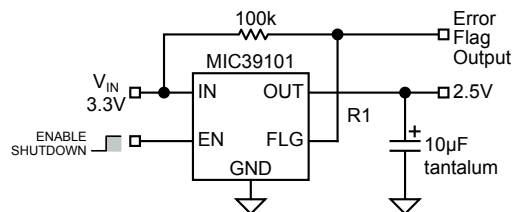

2.5V/1A Regulator with Error Flag

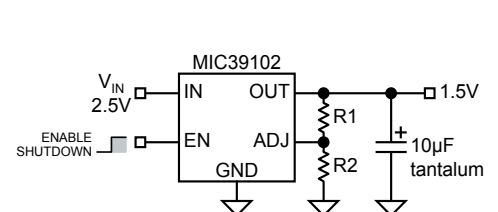

1.5V/1A Adjustable Regulator

Super beta PNP is a trademark of Micrel, Inc.

Ordering Information

| Part Number | | Voltage | Junction Temp. Range | Package |
|----------------|-----------------|---------|----------------------|---------|
| Standard | RoHS Compliant | | | |
| MIC39100-1.8BS | MIC39100-1.8WS* | 1.8V | -40°C to +125°C | SOT-223 |
| MIC39100-2.5BS | MIC39100-2.5WS* | 2.5V | -40°C to +125°C | SOT-223 |
| MIC39100-3.3BS | MIC39100-3.3WS* | 3.3V | -40°C to +125°C | SOT-223 |
| MIC39100-5.0BS | MIC39100-5.0WS* | 5.0V | -40°C to +125°C | SOT-223 |
| MIC39101-1.8BM | MIC39101-1.8YM | 1.8V | -40°C to +125°C | SOIC-8 |
| MIC39101-2.5BM | MIC39101-2.5YM | 2.5V | -40°C to +125°C | SOIC-8 |
| MIC39101-3.3BM | MIC39101-3.3YM | 3.3V | -40°C to +125°C | SOIC-8 |
| MIC39101-5.0BM | MIC39101-5.0YM | 5.0V | -40°C to +125°C | SOIC-8 |
| MIC39102BM | MIC39102YM | Adj. | -40°C to +125°C | SOIC-8 |

* RoHS compliant with 'high-melting solder' exemption.

Pin Configuration

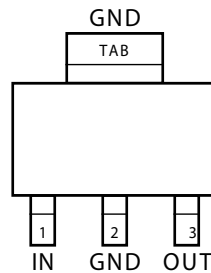

MIC39100-x.x
Fixed
SOT-223 (S)

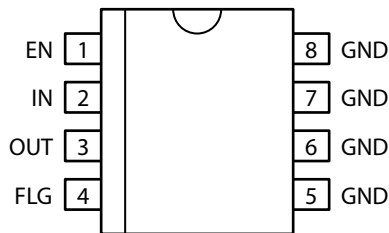

MIC39101-x.x
Fixed
SOIC-8 (M)

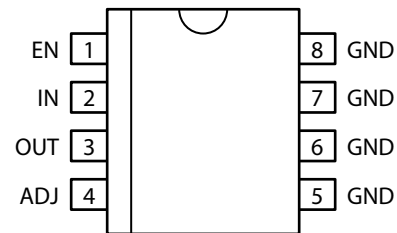

MIC39102
Adjustable
SOIC-8 (M)

Pin Description

| Pin No. MIC39100 | Pin No. MIC39101 | Pin No. MIC39102 | Pin Name | Pin Function |
|---------------------|---------------------|---------------------|----------|---|
| 1 | 1 | 1 | EN | Enable (Input): CMOS-compatible control input. Logic high = enable, logic low or open = shutdown. |
| | 2 | 2 | IN | Supply (Input) |
| 3 | 3 | 3 | OUT | Regulator Output |
| | 4 | | FLG | Flag (Output): Open-collector error flag output. Active low = output under-voltage. |
| | | 4 | ADJ | Adjustment Input: Feedback input. Connect to resistive voltage-divider network. |
| 2, TAB | 5-8 | 5-8 | GND | Ground |

Absolute Maximum Ratings (Note 1)

| | |
|--------------------------------------|-----------------|
| Supply Voltage (V_{IN}) | -20V to +20V |
| Enable Voltage (V_{EN}) | +20V |
| Storage Temperature (T_S) | -65°C to +150°C |
| Lead Temperature (soldering, 5 sec.) | 260°C |

ESD, **Note 3**

Operating Ratings (Note 2)

| | |
|--|-----------------|
| Supply Voltage (V_{IN}) | +2.25V to +16V |
| Enable Voltage (V_{EN}) | +16V |
| Maximum Power Dissipation ($P_{D(max)}$) | Note 4 |
| Junction Temperature (T_J) | -40°C to +125°C |
| Package Thermal Resistance | |
| SOT-223 (θ_{JC}) | 15°C/W |
| SOIC-8 (θ_{JC}) | 20°C/W |

Electrical Characteristics (Note 12)

$V_{IN} = V_{OUT} + 1V$; $V_{EN} = 2.25V$; $T_J = 25^\circ C$, **bold** values indicate $-40^\circ C \leq T_J \leq +125^\circ C$; unless noted

| Symbol | Parameter | Condition | Min | Typ | Max | Units |
|-------------------------------------|--|--|-------------|------|------------|---------|
| V_{OUT} | Output Voltage | 10mA | -1 | | 1 | % |
| | | $10mA \leq I_{OUT} \leq 1A$, $V_{OUT} + 1V \leq V_{IN} \leq 8V$ | -2 | | 2 | % |
| | Line Regulation | $I_{OUT} = 10mA$, $V_{OUT} + 1V \leq V_{IN} \leq 16V$ | | 0.06 | 0.5 | % |
| | Load Regulation | $V_{IN} = V_{OUT} + 1V$, $10mA \leq I_{OUT} \leq 1A$, | | 0.2 | 1 | % |
| $\Delta V_{OUT}/\Delta T$ ppm/°C | Output Voltage Temp. Coefficient, Note 5 | | | 40 | 100 | |
| V_{DO} | Dropout Voltage, Note 6 | $I_{OUT} = 100mA$, $\Delta V_{OUT} = -1\%$ | | 140 | 200 | mV |
| | | $I_{OUT} = 500mA$, $\Delta V_{OUT} = -1\%$ | | 275 | 250 | mV |
| | | $I_{OUT} = 750mA$, $\Delta V_{OUT} = -1\%$ | | 330 | 500 | mV |
| | | $I_{OUT} = 1A$, $\Delta V_{OUT} = -1\%$ | | 410 | 630 | mV |
| I_{GND} | Ground Current, Note 7 | $I_{OUT} = 100mA$, $V_{IN} = V_{OUT} + 1V$ | | 400 | | μA |
| | | $I_{OUT} = 500mA$, $V_{IN} = V_{OUT} + 1V$ | | 4 | | mA |
| | | $I_{OUT} = 750mA$, $V_{IN} = V_{OUT} + 1V$ | | 6.5 | | mA |
| | | $I_{OUT} = 1A$, $V_{IN} = V_{OUT} + 1V$ | | 11 | 20 | mA |
| $I_{OUT(lim)}$ | Current Limit | $V_{OUT} = 0V$, $V_{IN} = V_{OUT} + 1V$ | | 1.8 | 2.5 | A |
| Enable Input | | | | | | |
| V_{EN} | Enable Input Voltage | logic low (off) | | | 0.8 | V |
| | | logic high (on) | 2.25 | | | V |
| I_{EN} | Enable Input Current | $V_{EN} = 2.25V$ | 1 | 15 | 30 | μA |
| | | $V_{EN} = 0.8V$ | | | 75 | μA |
| | | | | | 2 | μA |
| | | | | | 4 | μA |
| Flag Output | | | | | | |
| $I_{FLG(leak)}$ | Output Leakage Current | $V_{OH} = 16V$ | | 0.01 | 1 | μA |
| | | | | | 2 | μA |
| $V_{FLG(do)}$ | Output Low Voltage | $V_{IN} = 2.250V$, $I_{OL} = 250\mu A$, Note 9 | | 210 | 300 | mV |
| | | | | | 400 | mV |
| V_{FLG} | Low Threshold | % of V_{OUT} | 93 | | | % |
| | High Threshold | % of V_{OUT} | | | 99.2 | % |
| | Hysteresis | | | 1 | | % |

| Symbol | Parameter | Condition | Min | Typ | Max | Units |
|----------------------|--|----------------|--------------|-------|------------------|----------|
| MIC39102 Only | | | | | | |
| | Reference Voltage | Note 10 | 1.228 | 1.240 | 1.252 | V |
| | | | 1.215 | | 1.265 | V |
| | | | 1.203 | | 1.277 | V |
| | Adjust Pin Bias Current | | | 40 | 80 120 | nA nA |
| ppm/°C | Reference Voltage | Note 7 | | 20 | | |
| | Temp. Coefficient | | | | | |
| | Adjust Pin Bias Current Temp. Coefficient | | | 0.1 | | nA/°C |

Note 1. Exceeding the absolute maximum ratings may damage the device.

Note 2. The device is not guaranteed to function outside its operating rating.

Note 3. Devices are ESD sensitive. Handling precautions recommended.

Note 4. $P_{D(max)} = (T_{J(max)} - T_A) \div \theta_{JA}$, where θ_{JA} depends upon the printed circuit layout. See "Applications Information."

Note 5. Output voltage temperature coefficient is $\Delta V_{OUT(worst\ case)} \div (T_{J(max)} - T_{J(min)})$ where $T_{J(max)}$ is +125°C and $T_{J(min)}$ is -40°C.

Note 6. $V_{DO} = V_{IN} - V_{OUT}$ when V_{OUT} decreases to 98% of its nominal output voltage with $V_{IN} = V_{OUT} + 1V$. For output voltages below 2.25V, dropout voltage is the input-to-output voltage differential with the minimum input voltage being 2.25V. Minimum input operating voltage is 2.25V.

Note 7. I_{GND} is the quiescent current. $I_{IN} = I_{GND} + I_{OUT}$.

Note 8. $V_{EN} \leq 0.8V$, $V_{IN} \leq 8V$, and $V_{OUT} = 0V$.

Note 9. For a 2.5V device, $V_{IN} = 2.250V$ (device is in dropout).

Note 10. $V_{REF} \leq V_{OUT} \leq (V_{IN} - 1V)$, $2.25V \leq V_{IN} \leq 16V$, $10mA \leq I_L \leq 1A$, $T_J = T_{MAX}$.

Note 11. Thermal regulation is defined as the change in output voltage at a time t after a change in power dissipation is applied, excluding load or line regulation effects. Specifications are for a 200mA load pulse at $V_{IN} = 16V$ for $t = 10ms$.

Note 12. Specification for packaged product only.

Typical Characteristics

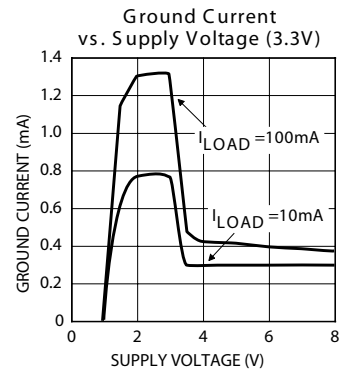
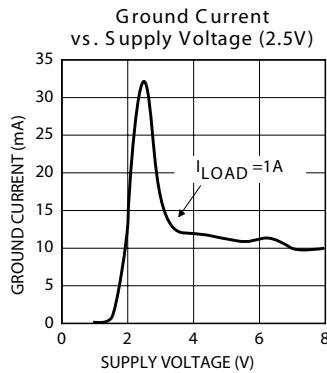
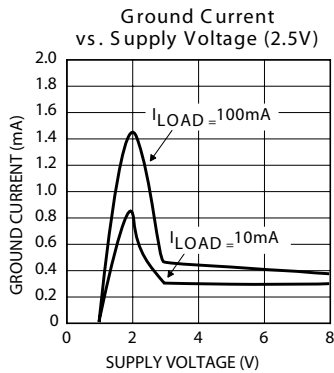
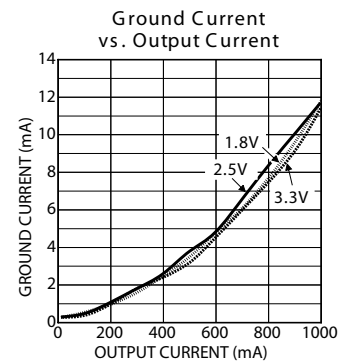
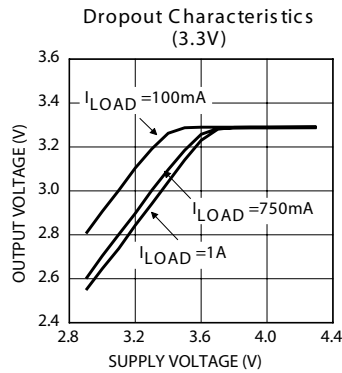
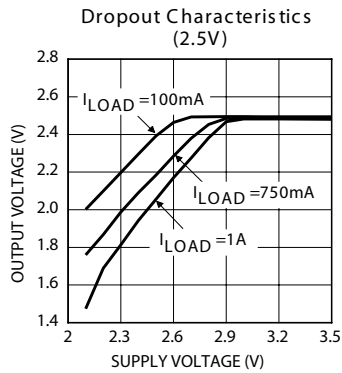
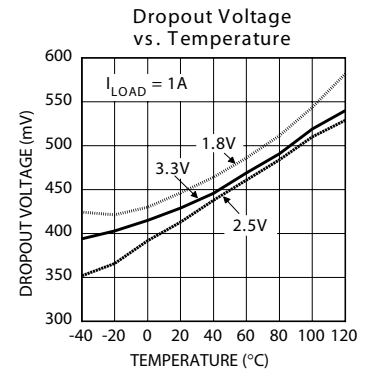
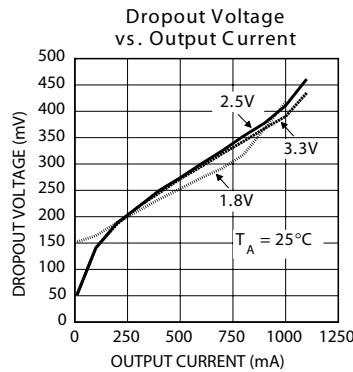
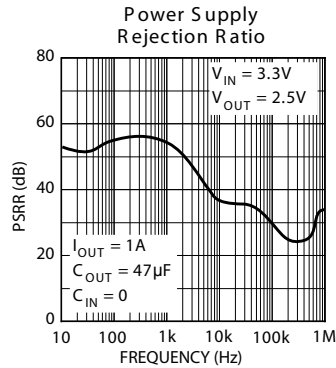
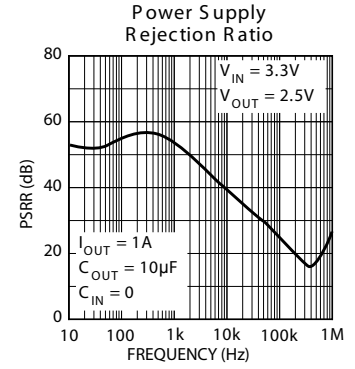
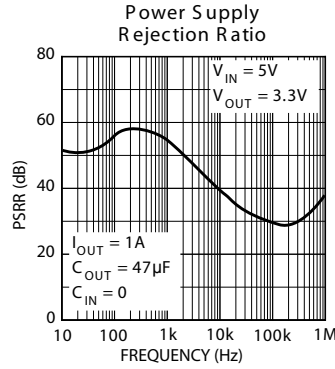
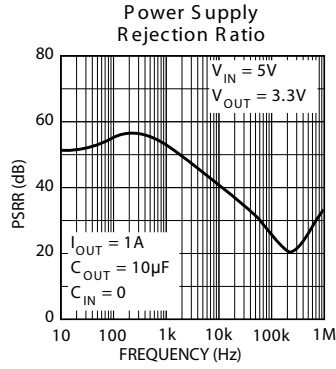

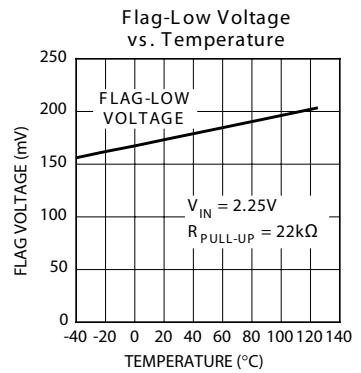
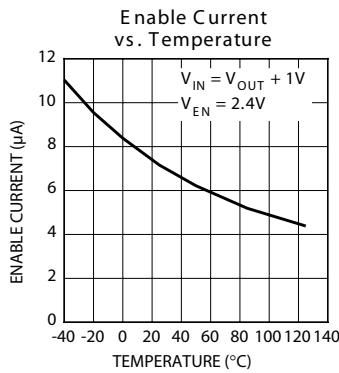
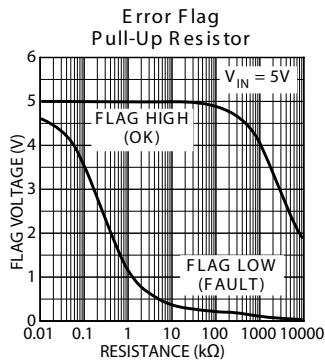
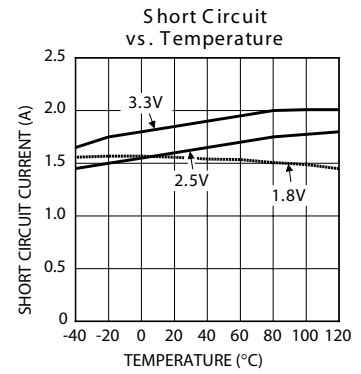
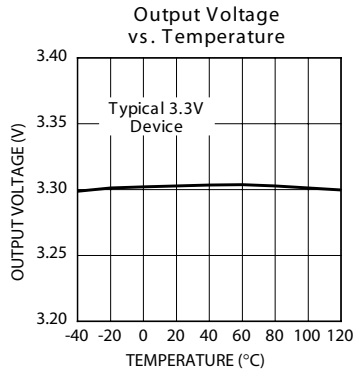
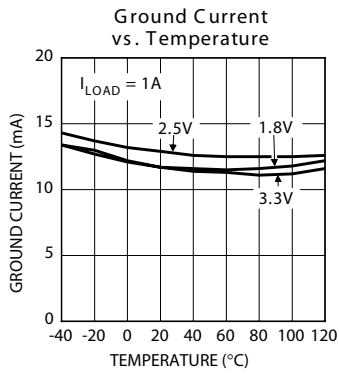
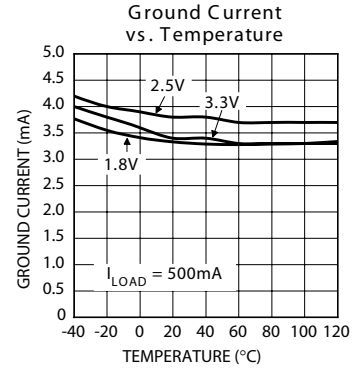
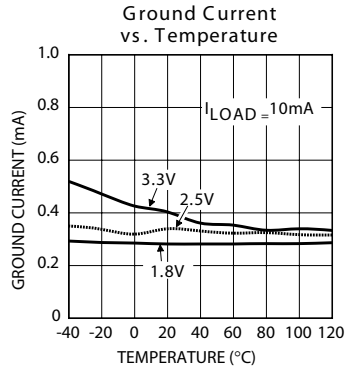
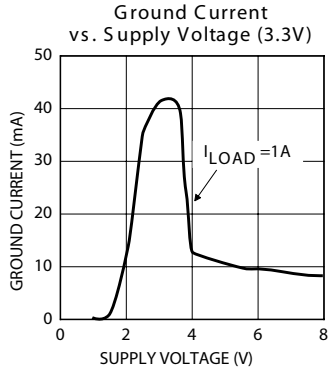

Functional Characteristics

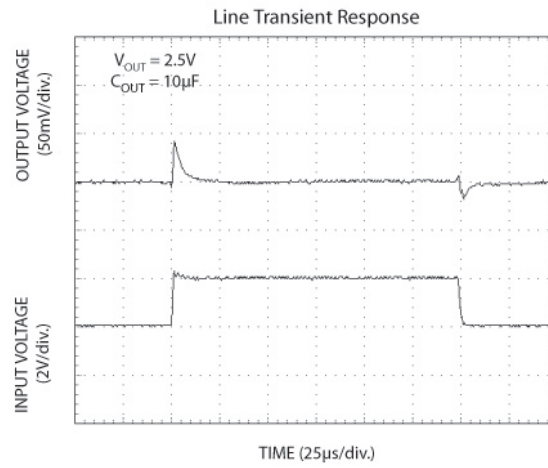
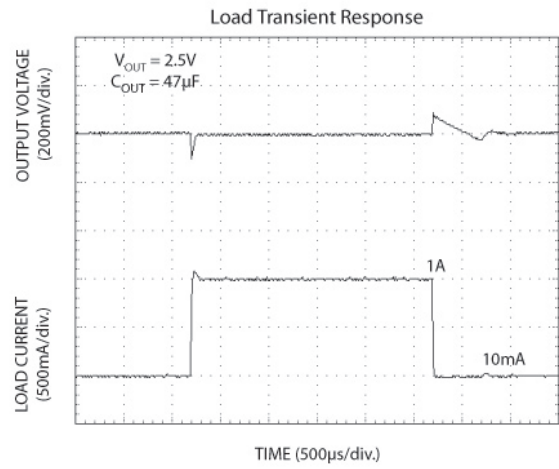
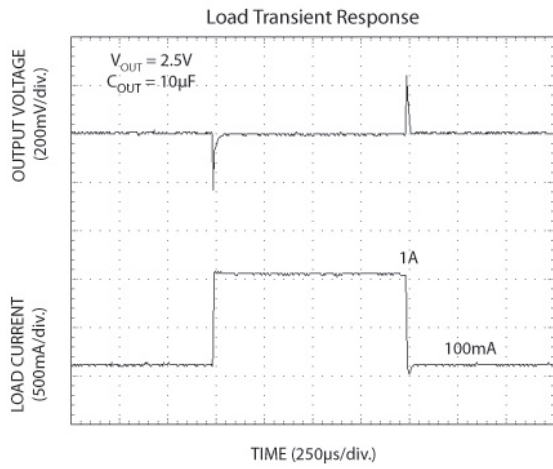

Functional Diagrams

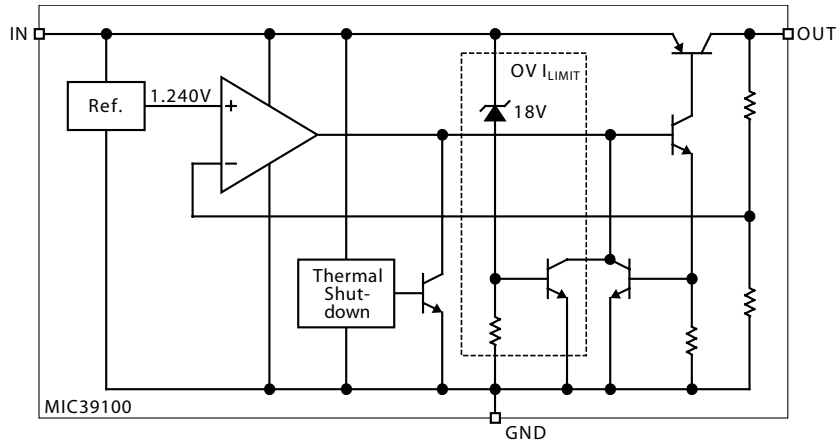

MIC39100 Fixed Regulator Block Diagram

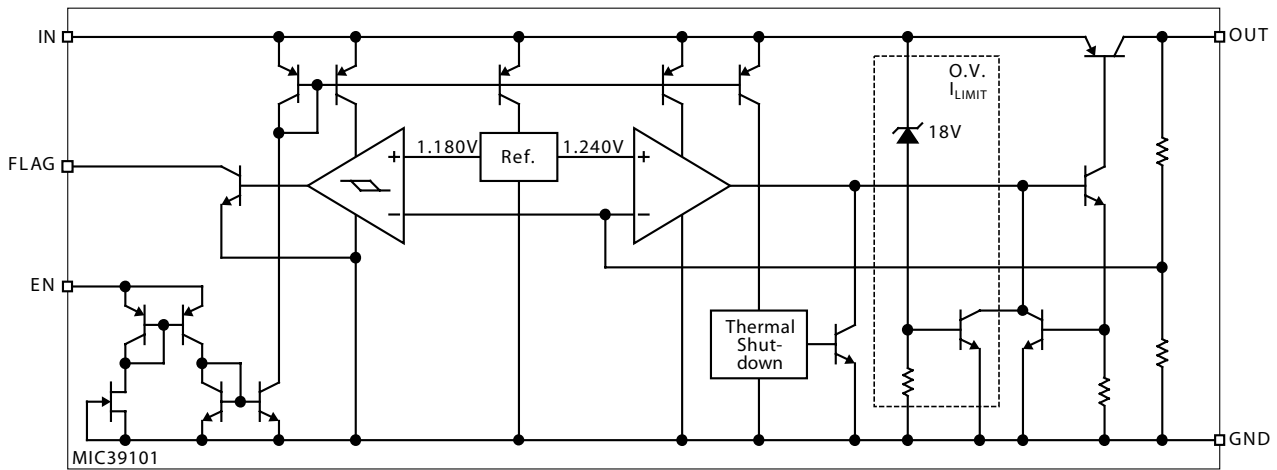

MIC39101 Fixed Regulator with Flag and Enable Block Diagram

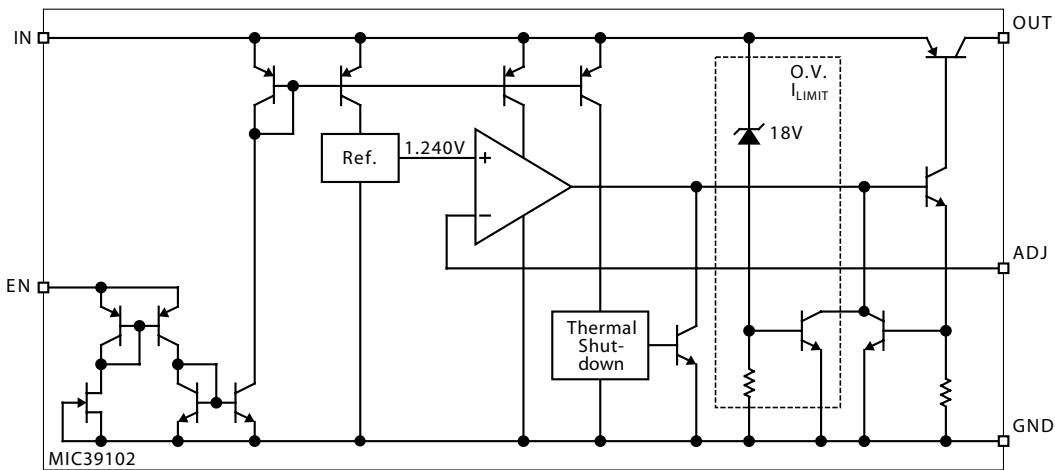

MIC39102 Adjustable Regulator Block Diagram

Applications Information

The MIC39100/1/2 is a high-performance low-dropout voltage regulator suitable for moderate to high-current voltage regulator applications. Its 630mV dropout voltage at full load and overtemperature makes it especially valuable in battery-powered systems and as high-efficiency noise filters in post-regulator applications. Unlike older NPN-pass transistor designs, where the minimum dropout voltage is limited by the base-to-emitter voltage drop and collector-to-emitter saturation voltage, dropout performance of the PNP output of these devices is limited only by the low V_{CE} saturation voltage.

A trade-off for the low dropout voltage is a varying base drive requirement. Micrel's Super β PNP™ process reduces this drive requirement to only 2% of the load current.

The MIC39100/1/2 regulator is fully protected from damage due to fault conditions. Linear current limiting is provided. Output current during overload conditions is constant. Thermal shutdown disables the device when the die temperature exceeds the maximum safe operating temperature. Transient protection allows device (and load) survival even when the input voltage spikes above and below nominal. The output structure of these regulators allows voltages in excess of the desired output voltage to be applied without reverse current flow.

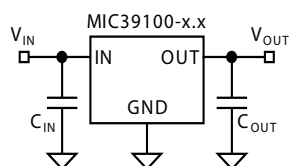

Figure 1. Capacitor Requirements

Output Capacitor

The MIC39100/1/2 requires an output capacitor to maintain stability and improve transient response. Proper capacitor selection is important to ensure proper operation. The MIC39100/1/2 output capacitor selection is dependent upon the ESR (equivalent series resistance) of the output capacitor to maintain stability. When the output capacitor is 10 μ F or greater, the output capacitor should have an ESR less than 2 Ω . This will improve transient response as well as promote stability. Ultra-low-ESR capacitors (<100m Ω), such as ceramic chip capacitors, may promote instability. These very low ESR levels may cause an oscillation and/or underdamped transient response. A low-ESR solid tantalum capacitor works extremely well and provides good transient response and stability over temperature. Aluminum electrolytics can also be used, as long as the ESR of the capacitor is <2 Ω .

The value of the output capacitor can be increased without limit. Higher capacitance values help to improve transient response and ripple rejection and reduce output noise.

Input Capacitor

An input capacitor of 1 μ F or greater is recommended when the device is more than 4 inches away from the bulk ac supply capacitance or when the supply is a battery. Small, surface mount, ceramic chip capacitors can be used for bypassing. Larger values will help to improve ripple rejection by bypassing the input to the regulator, further improving the integrity of the output voltage.

Error Flag

The MIC39101 features an error flag (FLG), which monitors the output voltage and signals an error condition when this voltage drops 5% below its expected value. The error flag is an open-collector output that pulls low under fault conditions and may sink up to 10mA. Low output voltage signifies a number of possible problems, including an overcurrent fault (the device is in current limit) or low input voltage. The flag output is inoperative during overtemperature conditions. A pull-up resistor from FLG to either V_{IN} or V_{OUT} is required for proper operation. For information regarding the minimum and maximum values of pull-up resistance, refer to the graph in the typical characteristics section of the data sheet.

Enable Input

The MIC39101 and MIC39102 versions feature an active-high enable input (EN) that allows on-off control of the regulator. Current drain reduces to "zero" when the device is shutdown, with only microamperes of leakage current. The EN input has TTL/CMOS compatible thresholds for simple logic interfacing. EN may be directly tied to V_{IN} and pulled up to the maximum supply voltage.

Transient Response and 3.3V to 2.5V or 2.5V to 1.8V Conversion

The MIC39100/1/2 has excellent transient response to variations in input voltage and load current. The device has been designed to respond quickly to load current variations and input voltage variations. Large output capacitors are not required to obtain this performance. A standard 10 μ F output capacitor, preferably tantalum, is all that is required. Larger values help to improve performance even further.

By virtue of its low-dropout voltage, this device does not saturate into dropout as readily as similar NPN-based designs. When converting from 3.3V to 2.5V or 2.5V to 1.8V, the NPN based regulators are already operating in dropout, with typical dropout requirements of 1.2V or greater. To convert down to 2.5V or 1.8V without operating in dropout, NPN-based regulators require an input voltage of 3.7V at the very least. The MIC39100 regulator will provide excellent performance with an input as low as 3.0V or 2.5V respectively. This gives the PNP based regulators a distinct advantage over older, NPN based linear regulators.

Minimum Load Current

The MIC39100/1/2 regulator is specified between finite loads. If the output current is too small, leakage currents dominate and the output voltage rises. A 10mA minimum load current is necessary for proper regulation.

Adjustable Regulator Design

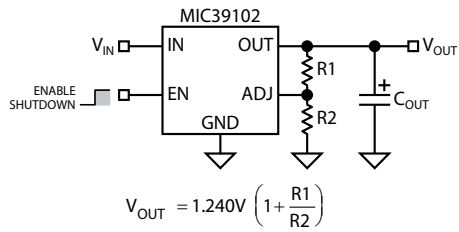

Figure 2. Adjustable Regulator with Resistors

The MIC39102 allows programming the output voltage anywhere between 1.24V and the 16V maximum operating rating of the family. Two resistors are used. Resistors can be quite large, up to 1MΩ, because of the very high input impedance and low bias current of the sense comparator: The resistor values are calculated by:

$$R1 = R2 \left(\frac{V_{OUT}}{1.240} - 1 \right)$$

Where V_O is the desired output voltage. Figure 2 shows component definition. Applications with widely varying load currents may scale the resistors to draw the minimum load current required for proper operation (see above).

Power SOIC-8 Thermal Characteristics

One of the secrets of the MIC39101/2's performance is its power SO-8 package featuring half the thermal resistance of a standard SO-8 package. Lower thermal resistance means more output current or higher input voltage for a given package size.

Lower thermal resistance is achieved by joining the four ground leads with the die attach paddle to create a single-piece electrical and thermal conductor. This concept has been used by MOSFET manufacturers for years, proving very reliable and cost effective for the user.

Thermal resistance consists of two main elements, θ_{JC} (junction-to-case thermal resistance) and θ_{CA} (case-to-ambient thermal resistance). See Figure 3. θ_{JC} is the resistance from the die to the leads of the package. θ_{CA} is the resistance from the leads to the ambient air and it includes θ_{CS} (case-to-sink thermal resistance) and θ_{SA} (sink-to-ambient thermal resistance).

Using the power SOIC-8 reduces the θ_{JC} dramatically and allows the user to reduce θ_{CA} . The total thermal resistance, θ_{JA} (junction-to-ambient thermal resistance) is the limiting factor in calculating the maximum power dissipation capability of the device. Typically, the power SOIC-8 has a θ_{JC} of 20°C/W, this is significantly lower than the standard SOIC-8 which is typically 75°C/W. θ_{CA} is reduced because pins 5 through 8 can now be soldered directly to a ground plane which significantly reduces the case-to-sink thermal resistance and sink to ambient thermal resistance.

Low-dropout linear regulators from Micrel are rated to a maximum junction temperature of 125°C. It is important not to exceed this maximum junction temperature during operation of the device. To prevent this maximum junction temperature from being exceeded, the appropriate ground plane heat sink must be used.

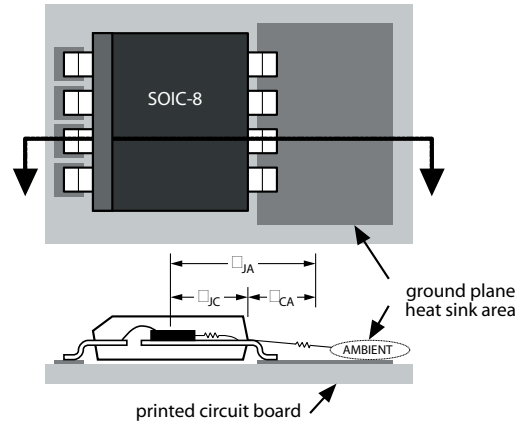

Figure 3. Thermal Resistance

Figure 4 shows copper area versus power dissipation with each trace corresponding to a different temperature rise above ambient.

From these curves, the minimum area of copper necessary for the part to operate safely can be determined. The maximum allowable temperature rise must be calculated to determine operation along which curve.

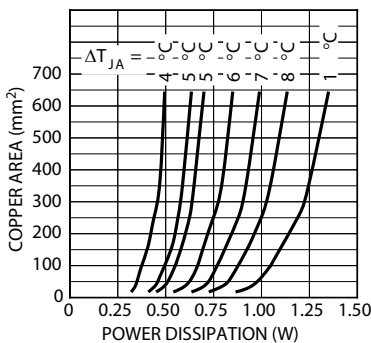

Figure 4. Copper Area vs. Power-SOIC Power Dissipation

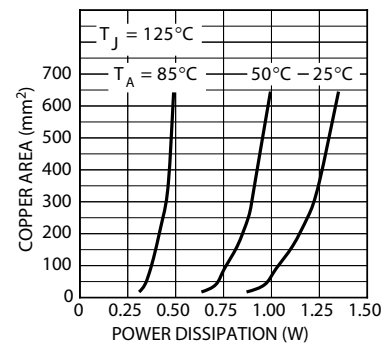

Figure 5. Copper Area vs. Power-SOIC Power Dissipation

$$\Delta T = T_{J(\max)} - T_{A(\max)}$$

$$T_{J(\max)} = 125^{\circ}\text{C}$$

$$T_{A(\max)} = \text{maximum ambient operating temperature}$$

For example, the maximum ambient temperature is 50°C , the ΔT is determined as follows:

$$\Delta T = 125^{\circ}\text{C} - 50^{\circ}\text{C}$$

$$\Delta T = 75^{\circ}\text{C}$$

Using Figure 4, the minimum amount of required copper can be determined based on the required power dissipation. Power dissipation in a linear regulator is calculated as follows:

$$P_D = (V_{IN} - V_{OUT}) I_{OUT} + V_{IN} \cdot I_{GND}$$

If we use a 2.5V output device and a 3.3V input at an output current of 1A, then our power dissipation is as follows:

$$P_D = (3.3\text{V} - 2.5\text{V}) \times 1\text{A} + 3.3\text{V} \times 11\text{mA}$$

$$P_D = 800\text{mW} + 36\text{mW}$$

$$P_D = 836\text{mW}$$

From Figure 4, the minimum amount of copper required to operate this application at a ΔT of 75°C is 160mm^2 .

Quick Method

Determine the power dissipation requirements for the design along with the maximum ambient temperature at which the device will be operated. Refer to Figure 5, which shows safe operating curves for three different ambient temperatures: 25°C , 50°C and 85°C . From these curves, the minimum amount of copper can be determined by knowing the maximum power dissipation required. If the maximum ambient temperature is 50°C and the power dissipation is as above, 836mW, the curve in Figure 5 shows that the required area of copper is 160mm^2 .

The θ_{JA} of this package is ideally 63°C/W , but it will vary depending upon the availability of copper ground plane to which it is attached.

Package Information

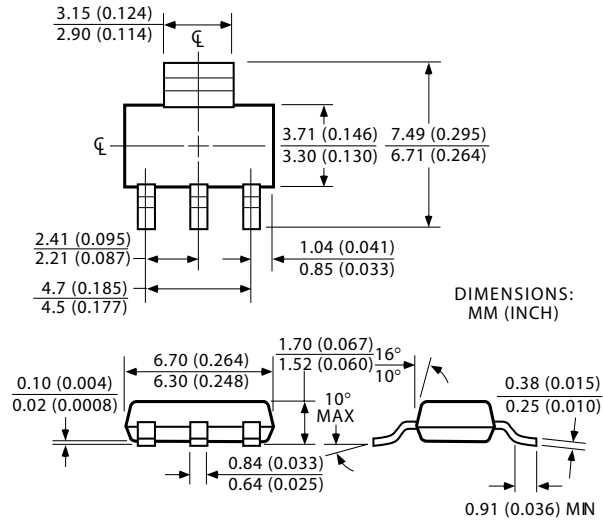

SOT-223 (S)

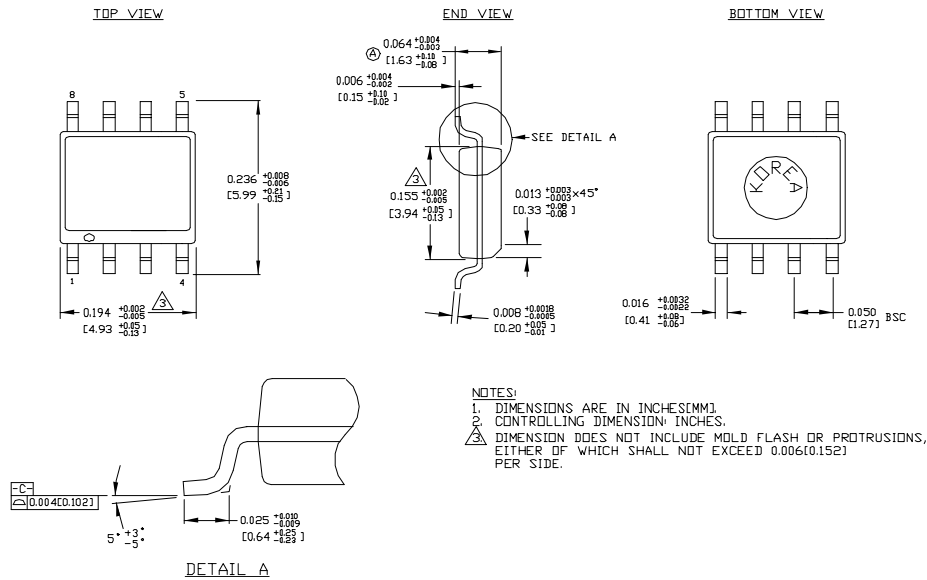

8-Lead SOIC (M)

MICREL INC. 2180 FORTUNE DRIVE SAN JOSE, CA 95131 USA

TEL + 1 (408) 944-0800 FAX + 1 (408) 474-1000 WEB <http://www.micrel.com>

This information furnished by Micrel in this data sheet is believed to be accurate and reliable. However no responsibility is assumed by Micrel for its use. Micrel reserves the right to change circuitry and specifications at any time without notification to the customer.

Micrel Products are not designed or authorized for use as components in life support appliances, devices or systems where malfunction of a product can reasonably be expected to result in personal injury. Life support devices or systems are devices or systems that (a) are intended for surgical implant into the body or (b) support or sustain life, and whose failure to perform can be reasonably expected to result in a significant injury to the user. A Purchaser's use or sale of Micrel Products for use in life support appliances, devices or systems is a Purchaser's own risk and Purchaser agrees to fully indemnify Micrel for any damages resulting from such use or sale.