



# UPI-41AH/42AH UNIVERSAL PERIPHERAL INTERFACE 8-BIT SLAVE MICROCONTROLLER

- UPI-41: 6 MHz; UPI-42: 12.5 MHz
- Pin, Software and Architecturally Compatible with all UPI-41 and UPI-42 Products
- 8-Bit CPU plus ROM/OTP EPROM, RAM, I/O, Timer/Counter and Clock in a Single Package
- 2048 x 8 ROM/OTP, 256 x 8 RAM on UPI-42, 1024 x 8 ROM/OTP, 128 x 8 RAM on UPI-41, 8-Bit Timer/Counter, 18 Programmable I/O Pins
- One 8-Bit Status and Two Data Registers for Asynchronous Slave-to-Master Interface
- DMA, Interrupt, or Polled Operation Supported
- Fully Compatible with all Intel and Most Other Microprocessor Families
- Interchangeable ROM and OTP EPROM Versions
- Expandable I/O
- Sync Mode Available
- Over 90 Instructions: 70% Single Byte
- Available in EXPRESS — Standard Temperature Range
- intelligent Programming Algorithm — Fast OTP Programming
- Available in 40-Lead Plastic and 44-Lead Plastic Leaded Chip Carrier Packages

(See Packaging Spec., Order #240800-001)  
Package Type P and N

The Intel UPI-41AH and UPI-42AH are general-purpose Universal Peripheral Interfaces that allow the designer to develop customized solutions for peripheral device control.

They are essentially "slave" microcontrollers, or microcontrollers with a slave interface included on the chip. Interface registers are included to enable the UPI device to function as a slave peripheral controller in the MCS Modules and iAPX family, as well as other 8-, 16-, and 32-bit systems.

To allow full user flexibility, the program memory is available in ROM and One-Time Programmable EPROM (OTP). All UPI-41AH and UPI-42AH devices are fully pin compatible for easy transition from prototype to production level designs.

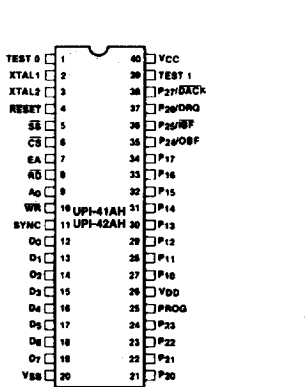

Figure 1. DIP Pin Configuration

210393-2

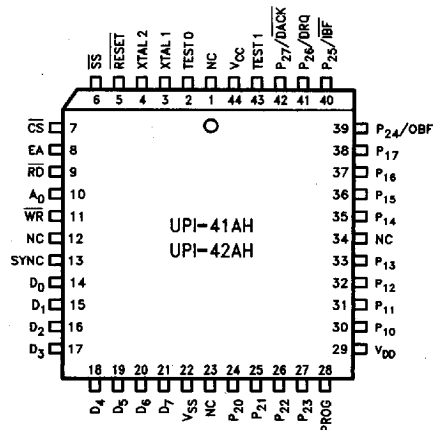

Figure 2. PLCC Pin Configuration

210393-3

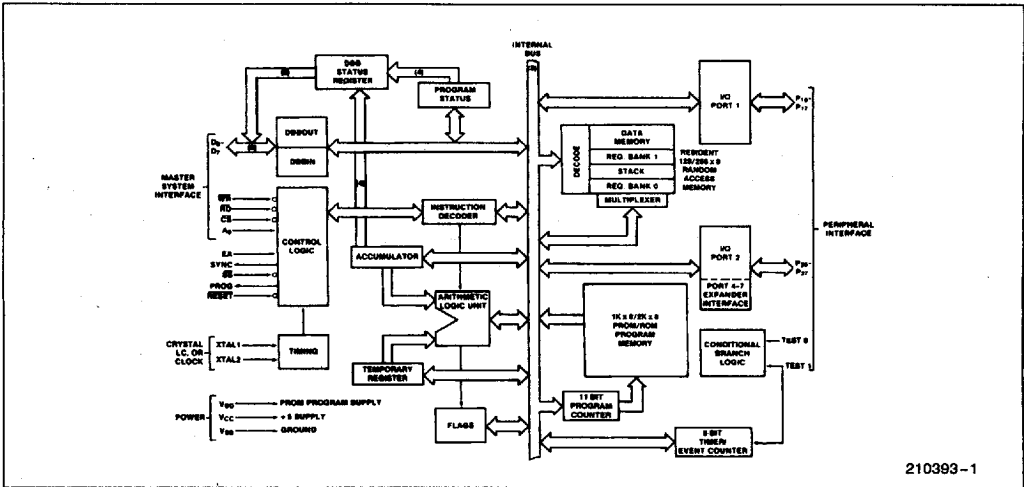

Figure 3. Block Diagram

**UPI PRODUCT MATRIX**

UPI Device	ROM	OTP EPROM	RAM	Programming Voltage
8042AH	2K	—	256	—
8242AH	2K	—	256	—
8742AH	—	2K	256	12.5V
8041AH	1K	—	128	—
8741AH	—	1K	128	12.5V

4

**THE INTEL 8242**

As shown in the UPI-42 product matrix, the UPI-42 will be offered as a pre-programmed 8042 with several software vendors' keyboard controller firmware. The current list of available 8242 versions include keyboard controller firmware from both Phoenix Technologies Ltd., IBM, and Award Software Inc. The 8242 is programmed with Phoenix Technologies Ltd. keyboard controller firmware for AT-compatible systems. This keyboard controller is fully compatible with all AT-compatible operating systems and applications. The 8242PC also contains Phoenix Technologies Ltd. firmware. This keyboard controller

provides support for AT, PS/2 and most EISA platforms as well as PS/2-style mouse support for either AT or PS/2 platforms.

The Intel 8242BB is programmed with IBM's keyboard controller firmware. The 8242BB provides an off the shelf keyboard and auxiliary device controller for AT, PS/2, EISA, and PCI architectures.

The 8242WA contains Award Software Inc. firmware. This device provides at AT-compatible keyboard controller for use in IBM PC AT compatible computers. The 8242WB contains a version of Award Software Inc. firmware that provides PS/2 style mouse support in addition to the standard features of the 8242WA.

\*Contact factory for current code revision available in all versions of the 8242 product lines.

Table 1. Pin Description

Symbol	DIP Pin No.	PLCC Pin No.	Type	Name and Function
TEST 0, TEST 1	1 39	2 43	I	<b>TEST INPUTS:</b> Input pins which can be directly tested using conditional branch instructions. <b>FREQUENCY REFERENCE:</b> TEST 1 (T <sub>1</sub> ) also functions as the event timer input (under software control). TEST 0 (T <sub>0</sub> ) is used during PROM programming and ROM/EPROM verification. It is also used during Sync Mode to reset the instruction state to S1 and synchronize the internal clock to PH1. See the Sync Mode Section.
XTAL 1, XTAL 2	2 3	3 4	I	<b>INPUTS:</b> Inputs for a crystal, LC or an external timing signal to determine the internal oscillator frequency.
RESET	4	5	I	<b>RESET:</b> Input used to reset status flip-flops and to set the program counter to zero. RESET is also used during EPROM programming and verification.
SS	5	6	I	<b>SINGLE STEP:</b> Single step input used in conjunction with the SYNC output to step the program through each instruction (EPROM). This should be tied to +5V when not used. This pin is also used to put the device in Sync Mode by applying 12.5V to it.
CS	6	7	I	<b>CHIP SELECT:</b> Chip select input used to select one UPI microcomputer out of several connected to a common data bus.
EA	7	8	I	<b>EXTERNAL ACCESS:</b> External access input which allows emulation, testing and ROM/EPROM verification. This pin should be tied low if unused.
RD	8	9	I	<b>READ:</b> I/O read input which enables the master CPU to read data and status words from the OUTPUT DATA BUS BUFFER or status register.
A <sub>0</sub>	9	10	I	<b>COMMAND/DATA SELECT:</b> Address input used by the master processor to indicate whether byte transfer is data (A <sub>0</sub> = 0, F1 is reset) or command (A <sub>0</sub> = 1, F1 is set). A <sub>0</sub> = 0 during program and verify operations.
WR	10	11	I	<b>WRITE:</b> I/O write input which enables the master CPU to write data and command words to the UPI INPUT DATA BUS BUFFER.
SYNC	11	13	O	<b>OUTPUT CLOCK:</b> Output signal which occurs once per UPI instruction cycle. SYNC can be used as a strobe for external circuitry; it is also used to synchronize single step operation.
D <sub>0</sub> -D <sub>7</sub> (BUS)	12-19	14-21	I/O	<b>DATA BUS:</b> Three-state, bidirectional DATA BUS BUFFER lines used to interface the UPI microcomputer to an 8-bit master system data bus.
P <sub>10</sub> -P <sub>17</sub>	27-34	30-33 35-38	I/O	<b>PORT 1:</b> 8-bit, PORT 1 quasi-bidirectional I/O lines. P <sub>10</sub> -P <sub>17</sub> access the signature row and security bit.
P <sub>20</sub> -P <sub>27</sub>	21-24 35-38	24-27 39-42	I/O	<b>PORT 2:</b> 8-bit, PORT 2 quasi-bidirectional I/O lines. The lower 4 bits (P <sub>20</sub> -P <sub>23</sub> ) interface directly to the 8243 I/O expander device and contain address and data information during PORT 4-7 access. The upper 4 bits (P <sub>24</sub> -P <sub>27</sub> ) can be programmed to provide interrupt Request and DMA Handshake capability. Software control can configure P <sub>24</sub> as Output Buffer Full (OBF) interrupt, P <sub>25</sub> as Input Buffer Full (IBF) interrupt, P <sub>26</sub> as DMA Request (DRQ), and P <sub>27</sub> as DMA ACKnowledge (DACK).
PROG	25	28	I/O	<b>PROGRAM:</b> Multifunction pin used as the program pulse input during PROM programming. During I/O expander access the PROG pin acts as an address/data strobe to the 8243. This pin should be tied high if unused.
V <sub>CC</sub>	40	44		<b>POWER:</b> +5V main power supply pin.
V <sub>DD</sub>	26	29		<b>POWER:</b> +5V during normal operation. +12.5V during programming operation. Low power standby supply pin.
V <sub>SS</sub>	20	22		<b>GROUND:</b> Circuit ground potential.

**UPI-41AH and UPI-42AH FEATURES**

1. Two Data Bus Buffers, one for input and one for output. This allows a much cleaner Master/Slave protocol.

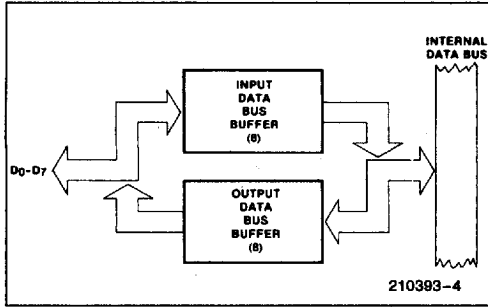

2. 8 Bits of Status

ST <sub>7</sub>	ST <sub>6</sub>	ST <sub>5</sub>	ST <sub>4</sub>	F <sub>1</sub>	F <sub>0</sub>	IBF	OBF
-----------------	-----------------	-----------------	-----------------	----------------	----------------	-----	-----

D<sub>7</sub> D<sub>6</sub> D<sub>5</sub> D<sub>4</sub> D<sub>3</sub> D<sub>2</sub> D<sub>1</sub> D<sub>0</sub>

ST<sub>4</sub>-ST<sub>7</sub> are user definable status bits. These bits are defined by the "MOV STS, A" single byte, single cycle instruction. Bits 4-7 of the accumulator are moved to bits 4-7 of the status register. Bits 0-3 of the status register are not affected.

MOV STS, A Op Code: 90H

1	0	0	1	0	0	0	0
---	---	---	---	---	---	---	---

D<sub>7</sub>

D<sub>0</sub>

3. RD and WR are edge triggered. IBF, OBF, F<sub>1</sub> and INT change internally after the trailing edge of RD or WR.

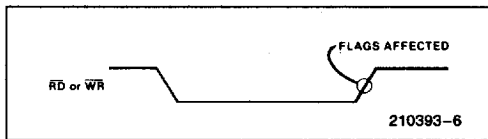

During the time that the host CPU is reading the status register, the UPI is prevented from updating this register or is 'locked out.'

4. P<sub>24</sub> and P<sub>25</sub> are port pins or Buffer Flag pins which can be used to interrupt a master processor. These pins default to port pins on Reset.

If the "EN FLAGS" instruction has been executed, P<sub>24</sub> becomes the OBF (Output Buffer Full) pin. A "1" written to P<sub>24</sub> enables the OBF pin (the pin outputs the OBF Status Bit). A "0" written to P<sub>24</sub> disables the OBF pin (the pin remains low). This pin can be used to indicate that valid data is available from the UPI (in Output Data Bus Buffer).

If "EN FLAGS" has been executed, P<sub>25</sub> becomes the IBF (Input Buffer Full) pin. A "1" written to P<sub>25</sub> enables the IBF pin (the pin outputs the inverse of the IBF Status Bit). A "0" written to P<sub>25</sub> disables the IBF pin (the pin remains low). This pin can be used to indicate that the UPI is ready for data.

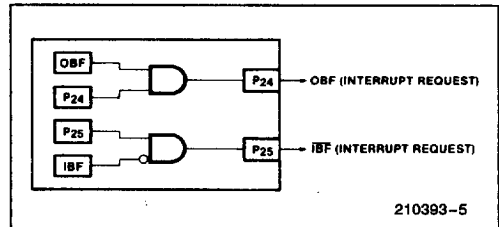

**Data Bus Buffer Interrupt Capability**

EN FLAGS Op Code: 0F5H

1	1	1	1	0	1	0	1
---	---	---	---	---	---	---	---

D<sub>7</sub>

D<sub>0</sub>

5. P<sub>26</sub> and P<sub>27</sub> are port pins or DMA handshake pins for use with a DMA controller. These pins default to port pins on Reset.

If the "EN DMA" instruction has been executed, P<sub>26</sub> becomes the DRQ (DMA Request) pin. A "1" written to P<sub>26</sub> causes a DMA request (DRQ is activated). DRQ is deactivated by DACK•RD, DACK•WR, or execution of the "EN DMA" instruction.

If "EN DMA" has been executed, P<sub>27</sub> becomes the DACK (DMA ACKnowledge) pin. This pin acts as a chip select input for the Data Bus Buffer registers during DMA transfers.

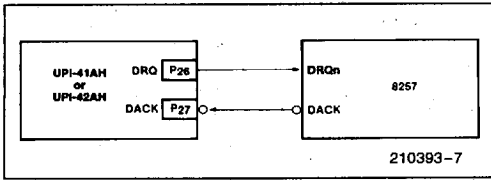

DMA Handshake Capability

EN DMA Op Code: 0E5H

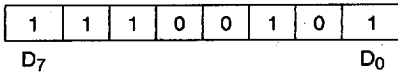

6. When EA is enabled on the UPI, the program counter is placed on Port 1 and the lower three bits of Port 2 (MSB = P<sub>22</sub>, LSB = P<sub>10</sub>). On the UPI this information is multiplexed with PORT DATA (see port timing diagrams at end of this data sheet).

7. The 8741AH and 8742AH support the intelligent Programming Algorithm. (See the Programming Section.)

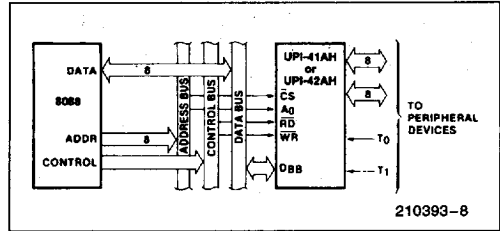

Figure 5. 8088-UPI-41AH/42AH Interface

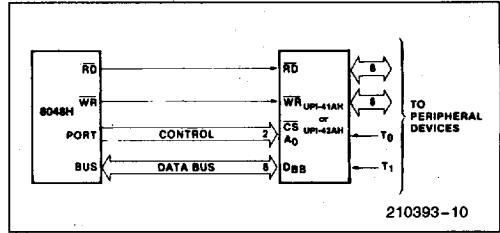

Figure 6. 8048H-UPI-41/42 Interface

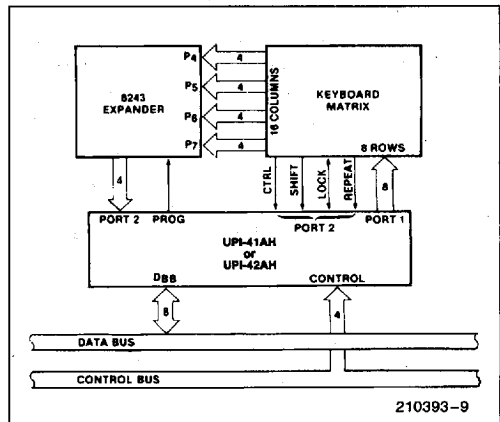

Figure 7. UPI-41/42-8243 Keyboard Scanner

APPLICATIONS

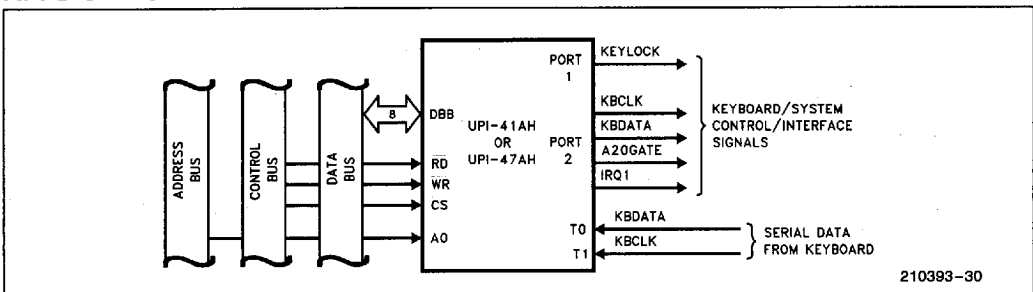

Figure 4. UPI-41AH/42AH Keyboard Controller

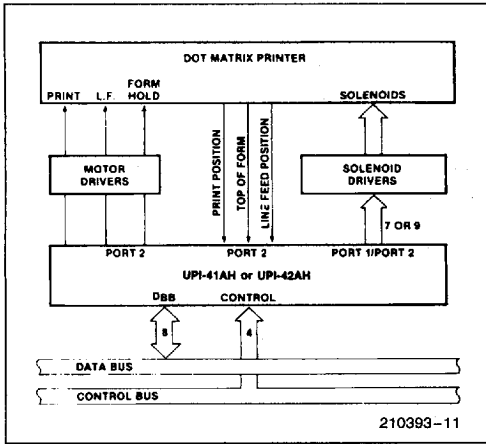

Figure 8. UPI-41AH/42AH 80-Column Matrix Printer Interface

### PROGRAMMING AND VERIFYING THE 8741AH AND 8742AH OTP EPROM

#### Programming Verification

In brief, the programming process consists of: activating the program mode, applying an address, latching the address, applying data, and applying a programming pulse. Each word is programmed completely before moving on to the next and is followed by a verification step. The following is a list of the pins used for programming and a description of their functions:

Pin	Function
XTAL 1	2 Clock Inputs
Reset	Initialization and Address Latching
Test 0	Selection of Program or Verify Mode
EA	Activation of Program/Verify Signature Row/Security Bit Modes
BUS	Address and Data Input Data Output During Verify
P <sub>20-22</sub>	Address Input
V <sub>DD</sub>	Programming Power Supply
PROG	Program Pulse Input

**WARNING**

An attempt to program a missocketed 8741AH or 8742AH will result in severe damage to the part. An indication of a properly socketed part is the appearance of the SYNC clock output. The lack of this clock may be used to disable the programmer.

The Program/Verify sequence is:

1. CS = 5V, V<sub>CC</sub> = 5V, V<sub>DD</sub> = 5V, RESET = 0V, A<sub>0</sub> = 0V, TEST 0 = 5V, clock applied or internal oscillator operating, BUS floating, PROG = 5V.
2. Insert 8741AH or 8742AH in programming socket
3. TEST 0 = 0V (select program mode)
4. EA = 12.5V (active program mode)
5. V<sub>CC</sub> = 6V (programming supply)
6. V<sub>DD</sub> = 12.5V (programming power)
7. Address applied to BUS and P<sub>20-22</sub>
8. RESET = 5V (latch address)
9. Data applied to BUS
10. PROG = 5V followed by one 1 ms pulse to 0V
11. TEST 0 = 5V (verify mode)
12. Read and verify data on BUS
13. TEST 0 = 0V
14. Apply overprogram pulse
15. RESET = 0V and repeat from step 6
16. Programmer should be at conditions of step 1 when 8741AH or 8742AH is removed from socket

Please follow the intelligent Programming flow chart for proper programming procedure.

#### intelligent Programming Algorithm

The intelligent Programming Algorithm rapidly programs Intel 8741AH/8742AH EPROMs using an efficient and reliable method particularly suited to the production programming environment. Typical programming time for individual devices is on the order of 10 seconds. Programming reliability is also ensured as the incremental program margin of each byte is continually monitored to determine when it has been successfully programmed. A flowchart of the 8741AH/8742AH intelligent Programming Algorithm is shown in Figure 9.

The intelligent Programming Algorithm utilizes two different pulse types: initial and overprogram. The duration of the initial PROG pulse(s) is one millisecond, which will then be followed by a longer overprogram pulse of length 3X msec. X is an iteration counter and is equal to the number of the initial one millisecond pulses applied to a particular 8741AH/8742AH location, before a correct verify occurs. Up to 25 one-millisecond pulses per byte are provided for before the overprogram pulse is applied.

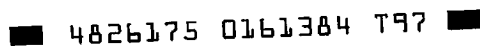

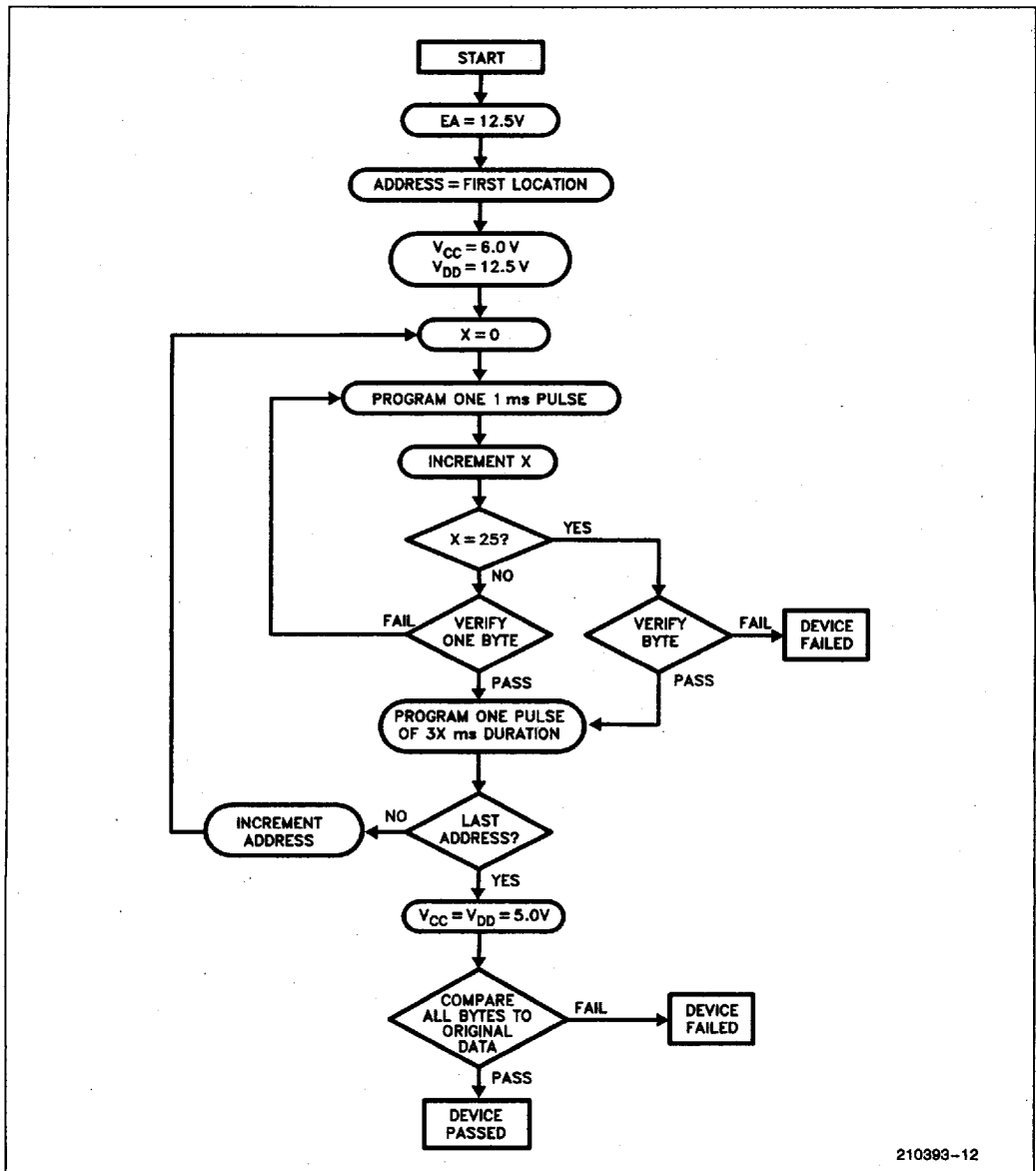

210393-12

Figure 9. Programming Algorithm

The entire sequence of program pulses and byte verifications is performed at  $V_{CC} = 6.0V$  and  $V_{DD} = 12.5V$ . When the intelligent Programming cycle has been completed, all bytes should be compared to the original data with  $V_{CC} = 5.0$ ,  $V_{DD} = 5V$ .

## Verify

A verify should be performed on the programmed bits to determine that they have been correctly programmed. The verify is performed with  $T_0 = 5V$ ,  $V_{DD} = 5V$ ,  $EA = 12.5V$ ,  $\overline{SS} = 5V$ ,  $PROG = 5V$ ,  $A_0 = 0V$ , and  $\overline{CS} = 5V$ .

## SECURITY BIT

The security bit is a single EPROM cell outside the EPROM array. The user can program this bit with the appropriate access code and the normal programming procedure, to inhibit any external access to the EPROM contents. Thus the user's resident program is protected. There is no direct external access to this bit. However, the security byte in the signature row has the same address and can be used to check indirectly whether the security bit has been programmed or not. The security bit has no effect on the signature mode, so the security byte can always be examined.

## SECURITY BIT PROGRAMMING/ VERIFICATION

### Programming

- a. Read the security byte of the signature mode. Make sure it is 00H.

- b. Apply access code to appropriate inputs to put the device into security mode.
- c. Apply high voltage to EA and  $V_{DD}$  pins.
- d. Follow the programming procedure as per the intelligent Programming Algorithm with known data on the databus. Not only the security bit, but also the security byte of the signature row is programmed.
- e. Verify that the security byte of the signature mode contains the same data as appeared on the data bus. (If  $DB_0-DB_7 = \text{high}$ , the security byte will contain FFH.)
- f. Read two consecutive known bytes from the EPROM array and verify that the wrong data are retrieved in at least one verification. If the EPROM can still be read, the security bit may have not been fully programmed though the security byte in the signature mode has.

### Verification

Since the security bit address overlaps the address of the security byte of the signature mode, it can be used to check indirectly whether the security bit has been programmed or not. Therefore, the security bit verification is a mere read operation of the security byte of the signature row (0FFH = security bit programmed; 00H = security bit unprogrammed). Note that during the security bit programming, the reading of the security byte does not necessarily indicate that the security bit has been successfully programmed. Thus, it is recommended that two consecutive known bytes in the EPROM array be read and the wrong data should be read at least once, because it is highly improbable that random data coincides with the correct ones twice.



**SIGNATURE MODE**

The UPI-41AH/42AH has an additional 32 bytes of EPROM available for Intel and user signatures and miscellaneous purposes. The 32 bytes are partitioned as follows:

- A. **Test code/checksum**—This can accommodate up to 25 bytes of code for testing the internal nodes that are not testable by executing from the external memory. The test code/checksum is present on ROMs, and OTPs.
- B. **Intel signature**—This allows the programmer to read from the UPI-41AH/42AH the manufacturer of the device and the exact product name. It facilitates automatic device identification and will be present in the ROM and OTP versions. Location 10H contains the manufacturer code. For Intel, it is 89H. Location 11H contains the device code.

The code is 43H and 42H for the 8042AH and OTP 8742AH, and 41H and 40H for the 8041AH and OTP 8741AH, respectively. The code is 44H for any device with the security bit set by Intel.

- C. **User signature**—The user signature memory is implemented in the EPROM and consists of 2 bytes for the customer to program his own signature code (for identification purposes and quick sorting of previously programmed materials).
- D. **Test signature**—This memory is used to store testing information such as: test data, bin number, etc. (for use in quality and manufacturing control).
- E. **Security byte**—This byte is used to check whether the security bit has been programmed (see the security bit section).

The signature mode can be accessed by setting P10 = 0, P11–P17 = 1, and then following the programming and/or verification procedures. The location of the various address partitions are as follows:

	Address		Device Type	No. of Bytes
Test Code/Checksum	0 16H	0FH 1EH	ROM/OTP	25
Intel Signature	10H	11H	ROM/OTP	2
User Signature	12H	13H	OTP	2
Test Signature	14H	15H	ROM/OTP	2
Security Byte	1FH		OTP	1

**SYNC MODE**

The Sync Mode is provided to ease the design of multiple controller circuits by allowing the designer to force the device into known phase and state time. The Sync Mode may also be utilized by automatic test equipment (ATE) for quick, easy, and efficient synchronizing between the tester and the DUT (device under test).

Sync Mode is enabled when  $\overline{SS}$  pin is raised to high voltage level of +12 volts. To begin synchronization,  $T_0$  is raised to 5 volts at least four clock cycles after  $\overline{SS}$ .  $T_0$  must be high for at least four X1 clock cycles to fully reset the prescaler and time state generators.  $T_0$  may then be brought down during low state of X1. Two clock cycles later, with the rising edge of X1, the device enters into Time State 1, Phase 1.  $\overline{SS}$  is then brought down to 5 volts 4 clocks later after  $T_0$ .  $\overline{RESET}$  is allowed to go high 5 tCY (75 clocks) later for normal execution of code.

**SYNC MODE TIMING DIAGRAMS**

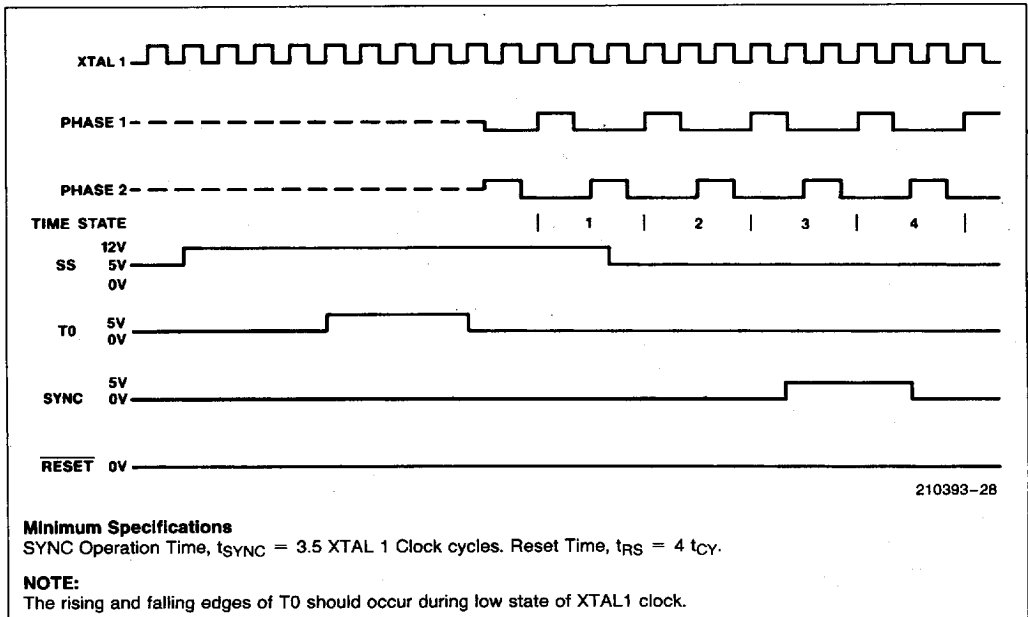

4

**ACCESS CODE**

The following table summarizes the access codes required to invoke the Sync Mode, Signature Mode, and the Security Bit, respectively. Also, the programming and verification modes are included for comparison.

Modes	Control Signals							Data Bus							Access Code												
	T0	RST	SS	EA	PROG	V <sub>DD</sub>	V <sub>CC</sub>								Port 2		Port 1										
								0	1	2	3	4	5	6	7	0	1	2	0	1	2	3	4	5	6	7	
Programming Mode	0	0	1	HV	1	V <sub>DDH</sub>	V <sub>CC</sub>	Address							Addr		a <sub>0</sub>	a <sub>1</sub>	X	X	X	X	X	X	X	X	
	0	1	1	HV	STB	V <sub>DDH</sub>	V <sub>CC</sub>	Data In							Addr												
Verification Mode	0	0	1	HV	1	V <sub>CC</sub>	V <sub>CC</sub>	Address							Addr		a <sub>0</sub>	a <sub>1</sub>	X	X	X	X	X	X	X	X	
	1	1	1	HV	1	V <sub>CC</sub>	V <sub>CC</sub>	Data Out							Addr												
Sync Mode	STB High	0	HV	0	X	V <sub>CC</sub>	V <sub>CC</sub>	X	X	X	X	X	X	X	X	X	X	X	X	X	X	X	X	X	X	X	X
Signature Mode	Prog	0	0	1	HV	1	V <sub>DDH</sub>	V <sub>CC</sub>	Addr. (see Sig Mode Table)							0 0 0		0	1	1	1	1	X	X	1		
		0	1	1	HV	STB	V <sub>DDH</sub>	V <sub>CC</sub>	Data In							0 0 0											
	Verify	0	0	1	HV	1	V <sub>CC</sub>	V <sub>CC</sub>	Addr. (see Sig Mode Table)							0 0 0											
		1	1	1	HV	1	V <sub>CC</sub>	V <sub>CC</sub>	Data Out							0 0 0											
Security Bit/Byte	Prog	0	0	1	HV	1	V <sub>DDH</sub>	V <sub>CC</sub>	Address							0 0 0											
		0	1	1	HV	STB	V <sub>DDH</sub>	V <sub>CC</sub>	Data In							0 0 0											
	Verify	0	0	1	HV	1	V <sub>CC</sub>	V <sub>CC</sub>	Address							0 0 0											
		1	1	1	HV	1	V <sub>CC</sub>	V <sub>CC</sub>	Data Out							0 0 0											

**NOTES:**

1. a<sub>0</sub> = 0 or 1; a<sub>1</sub> = 0 or 1. a<sub>0</sub> must = a<sub>1</sub>.

**ABSOLUTE MAXIMUM RATINGS\***

Ambient Temperature Under Bias . . . . .0°C to +70°C  
 Storage Temperature . . . . . -65°C to +150°C  
 Voltage on Any Pin with Respect to Ground . . . . . -0.5V to +7V  
 Power Dissipation . . . . . 1.5 W

NOTICE: This is a production data sheet. The specifications are subject to change without notice.

*\*WARNING: Stressing the device beyond the "Absolute Maximum Ratings" may cause permanent damage. These are stress ratings only. Operation beyond the "Operating Conditions" is not recommended and extended exposure beyond the "Operating Conditions" may affect device reliability.*

**D.C. CHARACTERISTICS** T<sub>A</sub> = 0°C to +70°C, V<sub>CC</sub> = V<sub>DD</sub> = +5V ± 10%

Symbol	Parameter	UPI-41AH/42AH		Units	Notes
		Min	Max		
V <sub>IL</sub>	Input Low Voltage (Except XTAL1, XTAL2, RESET)	-0.5	0.8	V	
V <sub>IL1</sub>	Input Low Voltage (XTAL1, XTAL2, RESET)	-0.5	0.6	V	
V <sub>IH</sub>	Input High Voltage (Except XTAL1, XTAL2, RESET)	2.0	V <sub>CC</sub>	V	
V <sub>IH1</sub>	Input High Voltage (XTAL1, RESET)	3.5	V <sub>CC</sub>	V	
V <sub>IH2</sub>	Input High Voltage (XTAL2)	2.2	V <sub>CC</sub>	V	
V <sub>OL</sub>	Output Low Voltage (D <sub>0</sub> -D <sub>7</sub> )		0.45	V	I <sub>OL</sub> = 2.0 mA

**D.C. CHARACTERISTICS**  $T_A = 0^\circ\text{C to } +70^\circ\text{C}$ ,  $V_{CC} = V_{DD} = +5\text{V} \pm 10\%$  (Continued)

Symbol	Parameter	UPI-41AH/42AH		Units	Notes
		Min	Max		
V <sub>OL1</sub>	Output Low Voltage (P <sub>10</sub> -P <sub>17</sub> , P <sub>20</sub> -P <sub>27</sub> , Sync)		0.45	V	I <sub>OL</sub> = 1.6 mA
V <sub>OL2</sub>	Output Low Voltage (PROG)		0.45	V	I <sub>OL</sub> = 1.0 mA
V <sub>OH</sub>	Output High Voltage (D <sub>0</sub> -D <sub>7</sub> )	2.4		V	I <sub>OH</sub> = -400 $\mu$ A
V <sub>OH1</sub>	Output High Voltage (All Other Outputs)	2.4			I <sub>OH</sub> = -50 $\mu$ A
I <sub>IL</sub>	Input Leakage Current (T <sub>0</sub> , T <sub>1</sub> , RD, WR, CS, A <sub>0</sub> , EA)		$\pm 10$	$\mu$ A	V <sub>SS</sub> $\leq$ V <sub>IN</sub> $\leq$ V <sub>CC</sub>
I <sub>OFL</sub>	Output Leakage Current (D <sub>0</sub> -D <sub>7</sub> , High Z State)		$\pm 10$	$\mu$ A	V <sub>SS</sub> + 0.45 $\leq$ V <sub>OUT</sub> $\leq$ V <sub>CC</sub>
I <sub>LI</sub>	Low Input Load Current (P <sub>10</sub> -P <sub>17</sub> , P <sub>20</sub> -P <sub>27</sub> )		0.3	mA	V <sub>IL</sub> = 0.8V
I <sub>LI1</sub>	Low Input Load Current (RESET, SS)		0.2	mA	V <sub>IL</sub> = 0.8V
I <sub>DD</sub>	V <sub>DD</sub> Supply Current		20	mA	Typical = 8 mA
I <sub>CC</sub> + I <sub>DD</sub>	Total Supply Current		135	mA	Typical = 80 mA
I <sub>DD Standby</sub>	Power Down Supply Current		20	mA	Typical = 8 mA
I <sub>IH</sub>	Input Leakage Current (P <sub>10</sub> -P <sub>17</sub> , P <sub>20</sub> -P <sub>27</sub> )		100	$\mu$ A	V <sub>IN</sub> = V <sub>CC</sub>
C <sub>IN</sub>	Input Capacitance		10	pF	T <sub>A</sub> = 25°C (1)
C <sub>IO</sub>	I/O Capacitance		20	pF	T <sub>A</sub> = 25°C (1)

**NOTE:**

1. Sampled, not 100% tested.

**D.C. CHARACTERISTICS—PROGRAMMING**
 $T_A = 25^\circ\text{C} \pm 5^\circ\text{C}$ ,  $V_{CC} = 6\text{V} \pm 0.25\text{V}$ ,  $V_{DD} = 12.5\text{V} \pm 0.5\text{V}$ 

Symbol	Parameter	Min	Max	Units
V <sub>DDH</sub>	V <sub>DD</sub> Program Voltage High Level	12	13	V(1)
V <sub>DDL</sub>	V <sub>DD</sub> Voltage Low Level	4.75	5.25	V
V <sub>PH</sub>	PROG Program Voltage High Level	2.0	5.5	V
V <sub>PL</sub>	PROG Voltage Low Level	-0.5	0.8	V
V <sub>EAH</sub>	Input High Voltage for EA	12.0	13.0	V(2)
V <sub>EAL</sub>	EA Voltage Low Level	-0.5	5.25	V
I <sub>DD</sub>	V <sub>DD</sub> High Voltage Supply Current		50.0	mA
I <sub>EA</sub>	EA High Voltage Supply Current		1.0	mA

**NOTES:**

1. Voltages over 13V applied to pin V<sub>DD</sub> will permanently damage the device.
2. V<sub>EAH</sub> must be applied to EA before V<sub>DDH</sub> and removed after V<sub>DDL</sub>.
3. V<sub>CC</sub> must be applied simultaneously or before V<sub>DD</sub> and must be removed simultaneously or after V<sub>DD</sub>.

**A.C. CHARACTERISTICS**  $T_A = 0^\circ\text{C}$  to  $+70^\circ\text{C}$ ,  $V_{SS} = 0\text{V}$ ,  $V_{CC} = V_{DD} = +5\text{V} \pm 10\%$ 
**DBB READ**

Symbol	Parameter	Min	Max	Units
$t_{AR}$	CS, $A_0$ Setup to RD $\downarrow$	0		ns
$t_{RA}$	CS, $A_0$ Hold After RD $\uparrow$	0		ns
$t_{RR}$	RD Pulse Width	160		ns
$t_{AD}$	CS, $A_0$ to Data Out Delay		130	ns
$t_{RD}$	RD $\downarrow$ to Data Out Delay	0	130	ns
$t_{DF}$	RD $\uparrow$ to Data Float Delay		85	ns

**DBB WRITE**

Symbol	Parameter	Min	Max	Units
$t_{AW}$	CS, $A_0$ Setup to WR $\downarrow$	0		ns
$t_{WA}$	CS, $A_0$ Hold After WR $\uparrow$	0		ns
$t_{WW}$	WR Pulse Width	160		ns
$t_{DW}$	Data Setup to WR $\uparrow$	130		ns
$t_{WD}$	Data Hold After WR $\uparrow$	0		ns

**CLOCK**

Symbol	Parameter	Min	Max	Units
$t_{CY}$ (UPI-41AH/42AH)	Cycle Time	1.2	9.20	$\mu\text{s}^{(1)}$
$t_{CYC}$ (UPI-41AH/42AH)	Clock Period	80	613	ns
$t_{PWH}$	Clock High Time	30		ns
$t_{PWL}$	Clock Low Time	30		ns
$t_R$	Clock Rise Time		10	ns
$t_F$	Clock Fall Time		10	ns

**NOTE:**1.  $t_{CY} = 15/f(\text{XTAL})$ **A.C. CHARACTERISTICS DMA**

Symbol	Parameter	Min	Max	Units
$t_{ACC}$	DACK to WR or RD	0		ns
$t_{CAC}$	RD or WR to DACK	0		ns
$t_{ACD}$	DACK to Data Valid	0	130	ns
$t_{CRQ}$	RD or WR to DRQ Cleared		110	ns <sup>(1)</sup>

**NOTE:**1.  $C_L = 150\text{ pF}$ .

**A.C. CHARACTERISTICS—PROGRAMMING**
 $T_A = 25^\circ\text{C} \pm 5^\circ\text{C}$ ,  $V_{CC} = 6\text{V} \pm 0.25\text{V}$ ,  $V_{DDL} = +5\text{V} \pm 0.25\text{V}$ ,  $V_{DDH} = 12.5\text{V} \pm 0.5\text{V}$   
**(8741AH/8742AH ONLY)**

Symbol	Parameter	Min	Max	Units
$t_{AW}$	Address Setup Time to RESET $\uparrow$	$4t_{CY}$		
$t_{WA}$	Address Hold Time After RESET $\uparrow$	$4t_{CY}$		
$t_{DW}$	Data in Setup Time to PROG $\downarrow$	$4t_{CY}$		
$t_{WD}$	Data in Hold Time After PROG $\uparrow$	$4t_{CY}$		
$t_{PW}$	Initial Program Pulse Width	0.95	1.05	ms <sup>(1)</sup>
$t_{TW}$	Test 0 Setup Time for Program Mode	$4t_{CY}$		
$t_{WT}$	Test 0 Hold Time After Program Mode	$4t_{CY}$		
$t_{DO}$	Test 0 to Data Out Delay		$4t_{CY}$	
$t_{WW}$	RESET Pulse Width to Latch Address	$4t_{CY}$		
$t_r, t_f$	PROG Rise and Fall Times	0.5	100	$\mu\text{s}$
$t_{CY}$	CPU Operation Cycle Time	2.5	3.75	$\mu\text{s}$
$t_{RE}$	RESET Setup Time Before EA $\uparrow$	$4t_{CY}$		
$t_{OPW}$	Overprogram Pulse Width	2.85	78.75	ms <sup>(2)</sup>
$t_{DE}$	EA High to $V_{DD}$ High	$1t_{CY}$		

**4**
**NOTES:**

1. Typical Initial Program Pulse width tolerance =  $1\text{ ms} \pm 5\%$ .
2. This variation is a function of the iteration counter value, X.
3. If TEST 0 is high,  $t_{DO}$  can be triggered by RESET  $\uparrow$ .

**A.C. CHARACTERISTICS PORT 2**  $T_A = 0^\circ\text{C to } +70^\circ\text{C}$ ,  $V_{CC} = +5\text{V} \pm 10\%$ 

Symbol	Parameter	$f(t_{CY})^{(3)}$	Min	Max	Units
$t_{CP}$	Port Control Setup Before Falling Edge of PROG	$1/15 t_{CY} - 28$	55		ns <sup>(1)</sup>
$t_{PC}$	Port Control Hold After Falling Edge of PROG	$1/10 t_{CY}$	125		ns <sup>(2)</sup>
$t_{PR}$	PROG to Time P2 Input Must Be Valid	$8/15 t_{CY} - 16$		650	ns <sup>(1)</sup>
$t_{PF}$	Input Data Hold Time		0	150	ns <sup>(2)</sup>
$t_{DP}$	Output Data Setup Time	$2/10 t_{CY}$	250		ns <sup>(1)</sup>
$t_{PD}$	Output Data Hold Time	$1/10 t_{CY} - 80$	45		ns <sup>(2)</sup>
$t_{PP}$	PROG Pulse Width	$6/10 t_{CY}$	750		ns

**NOTES:**

1.  $C_L = 80\text{ pF}$ .
2.  $C_L = 20\text{ pF}$ .
3.  $t_{CY} = 1.25\text{ }\mu\text{s}$ .

**A.C. TESTING INPUT/OUTPUT WAVEFORM**

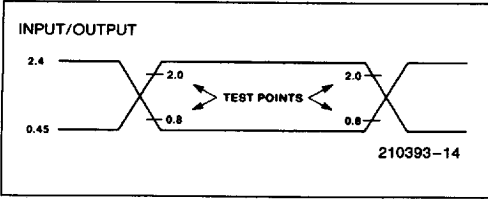

**A.C. TESTING LOAD CIRCUIT**

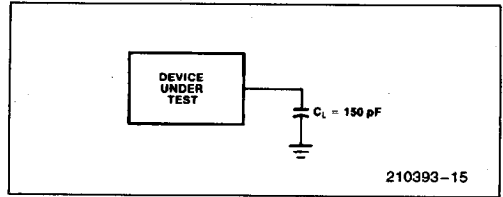

**DRIVING FROM EXTERNAL SOURCE-TWO OPTIONS**

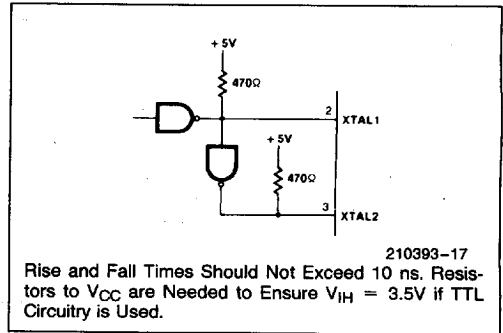
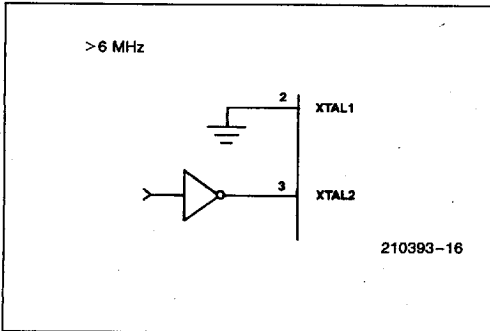

**LC OSCILLATOR MODE**

L	C	NOMINAL
45 H	20 pF	5.2 MHz
120 H	20 pF	3.2 MHz

$$f = \frac{1}{2\pi\sqrt{LC}}$$

$$C = \frac{C + 3C_{pp}}{2}$$

$C_{pp} \approx 5-10$  pF  
Pin-to-Pin Capacitance

Each C Should be Approximately 20 pF, including Stray Capacitance.

**CRYSTAL OSCILLATOR MODE**

1.00-12.5 MHz

- C1 5 pF (STRAY 5 pF)
- C2 (CRYSTAL + STRAY) 8 pF
- C3 20-30 pF INCLUDING STRAY

Crystal Series Resistance Should be Less Than 30Ω at 12.5 MHz.

WAVEFORMS

READ OPERATION—DATA BUS BUFFER REGISTER

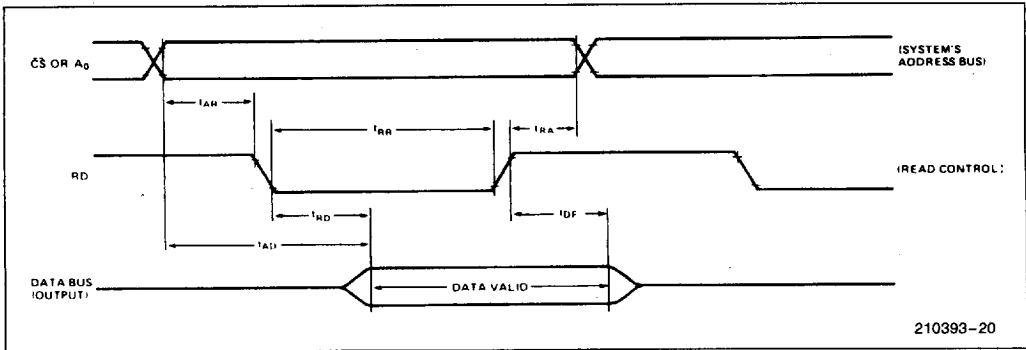

WRITE OPERATION—DATA BUS BUFFER REGISTER

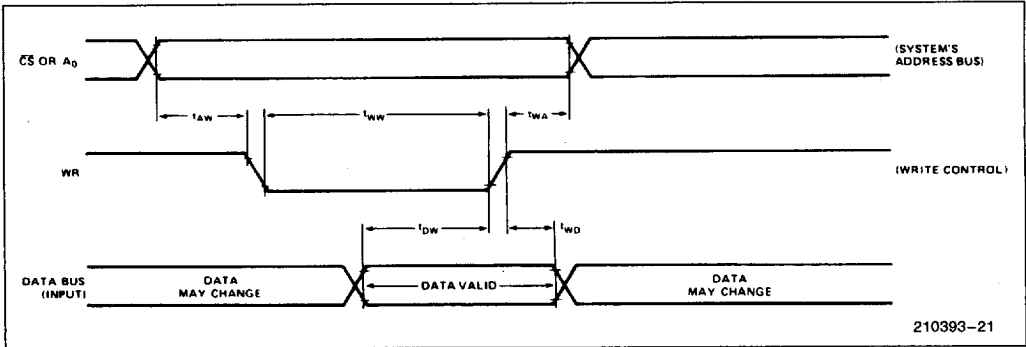

4

CLOCK TIMING

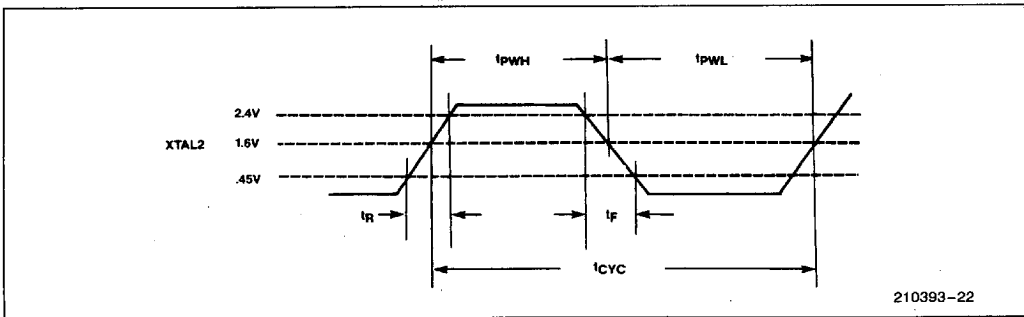



WAVEFORMS (Continued)

COMBINATION PROGRAM/VERIFY MODE

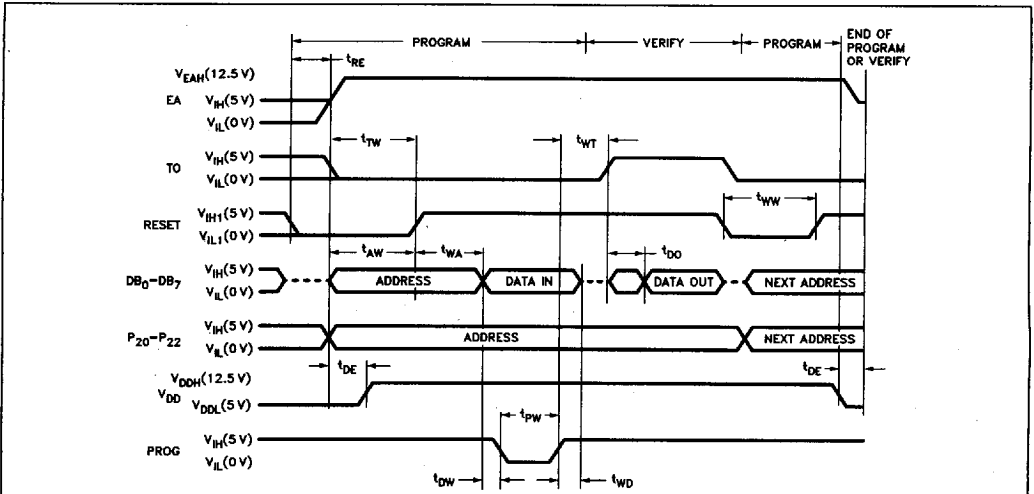

210393-23

NOTES:

1. A<sub>0</sub> must be held low (0V) during program/verify modes.
2. For V<sub>IH</sub>, V<sub>IH1</sub>, V<sub>IL</sub>, V<sub>IL1</sub>, V<sub>DDH</sub>, and V<sub>DDL</sub>, please consult the D.C. Characteristics Table.
3. When programming the 8741AH/8742AH, a 0.1 μF capacitor is required across V<sub>DD</sub> and ground to suppress spurious voltage transients which can damage the device.

VERIFY MODE

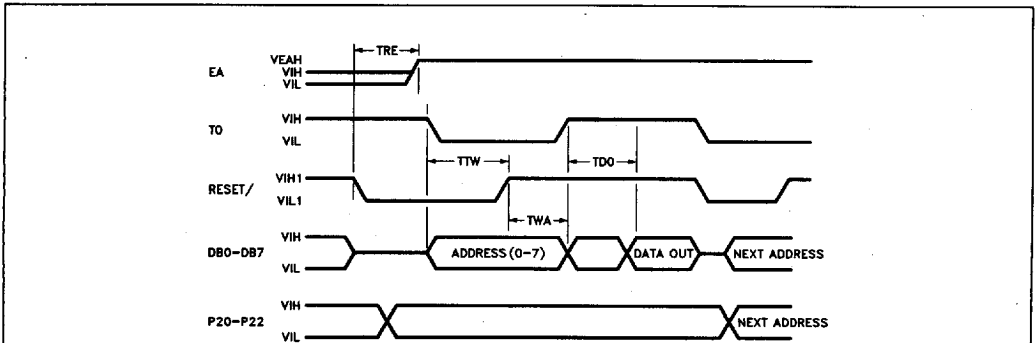

210393-29

NOTES:

1. PROG must float if EA is low.
2. PROG must float or = 5V when EA is high.
3. P<sub>10</sub>-P<sub>17</sub> = 5V or must float.
4. P<sub>24</sub>-P<sub>27</sub> = 5V or must float.
5. A<sub>0</sub> must be held low during programming/verify modes.

WAVEFORMS (Continued)

DMA

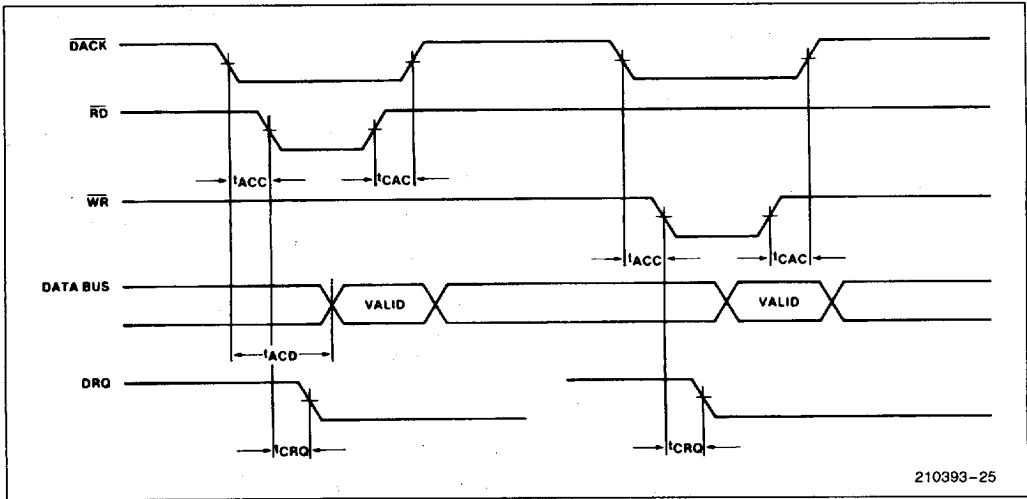

210393-25

4

PORT 2

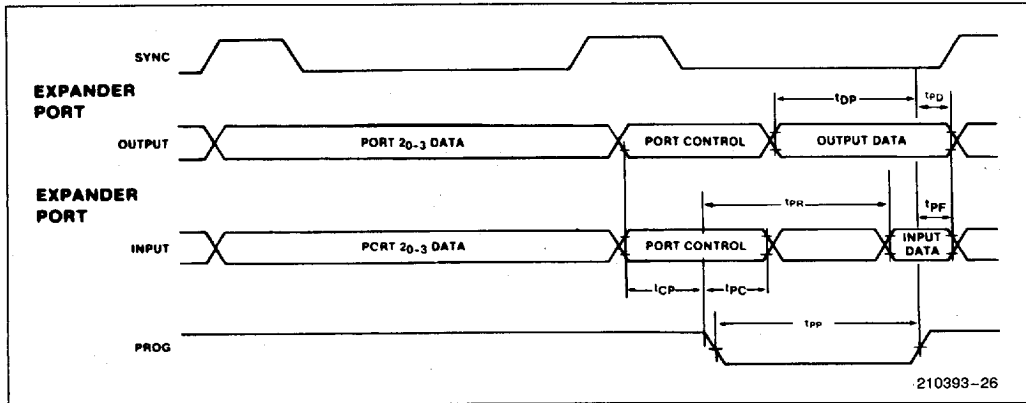

210393-26

PORT TIMING DURING EXTERNAL ACCESS (EA)

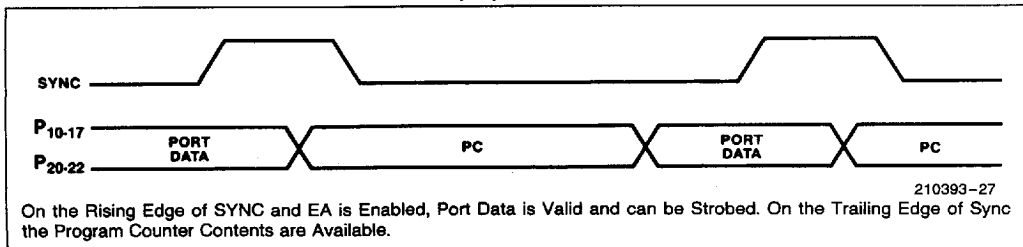

210393-27

On the Rising Edge of SYNC and EA is Enabled, Port Data is Valid and can be Strobed. On the Trailing Edge of Sync the Program Counter Contents are Available.

Table 2. UPI Instruction Set

Mnemonic	Description	Bytes	Cycles
<b>ACCUMULATOR</b>			
ADD A, Rr	Add register to A	1	1
ADD A, @Rr	Add data memory to A	1	1
ADD A, #data	Add immediate to A	2	2
ADDC A, Rr	Add register to A with carry	1	1
ADDC A, @Rr	Add data memory to A with carry	1	1
ADDC A, #data	Add immediate to A with carry	2	2
ANL A, Rr	AND register to A	1	1
ANL A, @Rr	AND data memory to A	1	1
ANL A, #data	AND immediate to A	2	2
ORL A, Rr	OR register to A	1	1
ORL A, @Rr	OR data memory to A	1	1
ORL A, #data	OR immediate to A	2	2
XRL A, Rr	Exclusive OR register to A	1	1
XRL A, @Rr	Exclusive OR data memory to A	1	1
XRL A, #data	Exclusive OR immediate to A	2	2
INC A	Increment A	1	1
DEC A	Decrement A	1	1
CLR A	Clear A	1	1
CPL A	Complement A	1	1
DA A	Decimal Adjust A	1	1
SWAP A	Swap nibbles of A	1	1
RL A	Rotate A left	1	1
RLC A	Rotate A left through carry	1	1
RR A	Rotate A right	1	1
RRC A	Rotate A right through carry	1	1
<b>INPUT/OUTPUT</b>			
IN A, Pp	Input port to A	1	2
OUTL Pp, A	Output A to port	1	2
ANL Pp, #data	AND immediate to port	2	2
ORL Pp, #data	OR immediate to port	2	2
IN A, DBB	Input DBB to A, clear IBF	1	1
OUT DBB, A	Output A to DBB, set OBF	1	1
MOV STS, A	A <sub>4</sub> -A <sub>7</sub> to Bits 4-7 of Status	1	1
MOVD A, Pp	Input Expander port to A	1	2
MOVD Pp, A	Output A to Expander port	1	2
ANLD Pp, A	AND A to Expander port	1	2
ORLD Pp, A	OR A to Expander port	1	2
<b>DATA MOVES</b>			
MOV A, Rr	Move register to A	1	1
MOV A, @Rr	Move data memory to A	1	1
MOV A, #data	Move immediate to A	2	2
MOV Rr, A	Move A to register	1	1
MOV @Rr, A	Move A to data memory	1	1
MOV Rr, #data	Move immediate to register	2	2
MOV @Rr, #data	Move immediate to data memory	2	2
MOV A, PSW	Move PSW to A	1	1
MOV PSW, A	Move A to PSW	1	1
XCH A, Rr	Exchange A and register	1	1
XCH A, @Rr	Exchange A and data memory	1	1
XCHD A, @Rr	Exchange digit of A and register	1	1
MOVP A, @A	Move to A from current page	1	2
MOVP3 A, @A	Move to A from page 3	1	2
<b>TIMER/COUNTER</b>			
MOV A, T	Read Timer/Counter	1	1
MOV T, A	Load Timer/Counter	1	1
STRT T	Start Timer	1	1
STRT CNT	Start Counter	1	1
STOP TCNT	Stop Timer/Counter	1	1
EN TCNTI	Enable Timer/Counter Interrupt	1	1
DIS TCNTI	Disable Timer/Counter Interrupt	1	1
<b>CONTROL</b>			
EN DMA	Enable DMA Handshake Lines	1	1
EN I	Enable IBF Interrupt	1	1
DIS I	Disable IBF Interrupt	1	1
EN FLAGS	Enable Master Interrupts	1	1
SEL RB0	Select register bank 0	1	1
SEL RB1	Select register bank 1	1	1
NOP	No Operation	1	1
<b>REGISTERS</b>			
INC Rr	Increment register	1	1
INC @Rr	Increment data memory	1	1
DEC Rr	Decrement register	1	1

Table 2. UPI Instruction Set (Continued)

Mnemonic	Description	Bytes	Cycles
<b>SUBROUTINE</b>			
CALL addr	Jump to subroutine	2	2
RET	Return	1	2
RETR	Return and restore status	1	2
<b>FLAGS</b>			
CLR C	Clear Carry	1	1
CPL C	Complement Carry	1	1
CLR F0	Clear Flag 0	1	1
CPL F0	Complement Flag 0	1	1
CLR F1	Clear F1 Flag	1	1
CPL F1	Complement F1 Flag	1	1
<b>BRANCH</b>			
JMP addr	Jump unconditional	2	2
JMPP @A	Jump indirect	1	2
DJNZ Rr, addr	Decrement register and jump	2	2
JC addr	Jump on Carry = 1	2	2
JNC addr	Jump on Carry = 0	2	2
JZ addr	Jump on A Zero	2	2
JNZ addr	Jump on A not Zero	2	2
JT0 addr	Jump on T0 = 1	2	2
JNT0 addr	Jump on T0 = 0	2	2
JT1 addr	Jump on T1 = 1	2	2
JNT1 addr	Jump on T1 = 0	2	2
JF0 addr	Jump on F0 Flag = 1	2	2
JF1 addr	Jump on F1 Flag = 1	2	2
JTF addr	Jump on Timer Flag = 1, Clear Flag	2	2
JNIBF addr	Jump on IBF Flag = 0	2	2
JOBF addr	Jump on OBF Flag = 1	2	2
JBb addr	Jump on Accumulator Bit	2	2