

HEC2707-012010
Type E Horizontal Type

h=2.5

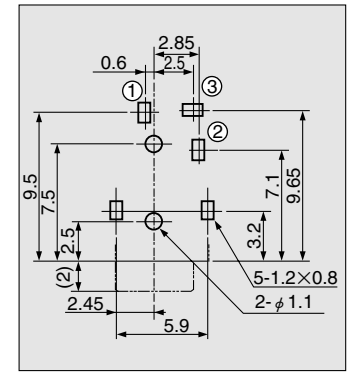
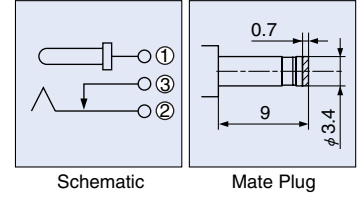
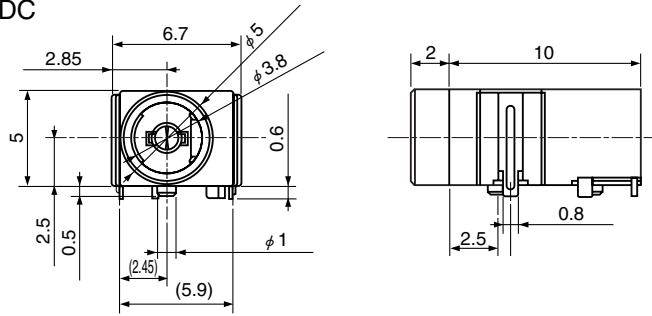

Rating: 0.5 A 12 V DC

 補強端子付き
 With terminal
 for reinforcement

**HOLE LAYOUT
(TOP VIEW)**

Housing Color	Model No.
Black	HEC2707-012010

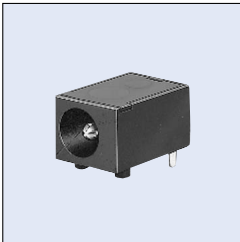
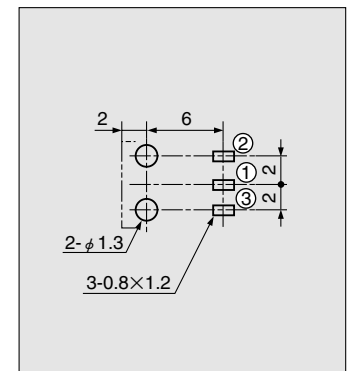
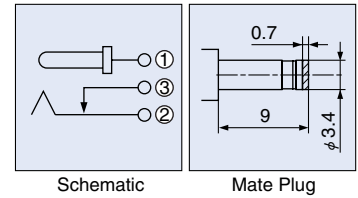
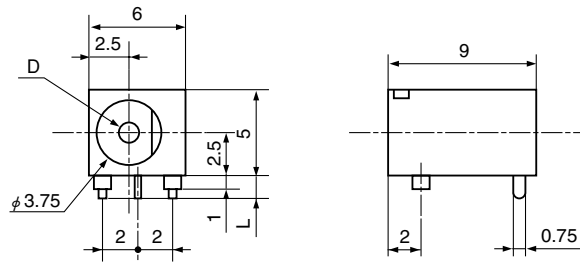
HEC2711-01-020
Type E Horizontal Type

h=2.5

Rating: 0.5 A 12 V DC

**HOLE LAYOUT
(BOTTOM VIEW)**

Dimension		Model No.
D	L	
φ 1.3	1.5	HEC2711-01-020
	3	HEC2711-01-620