

*Fox Redefines
Oscillator Delivery.*

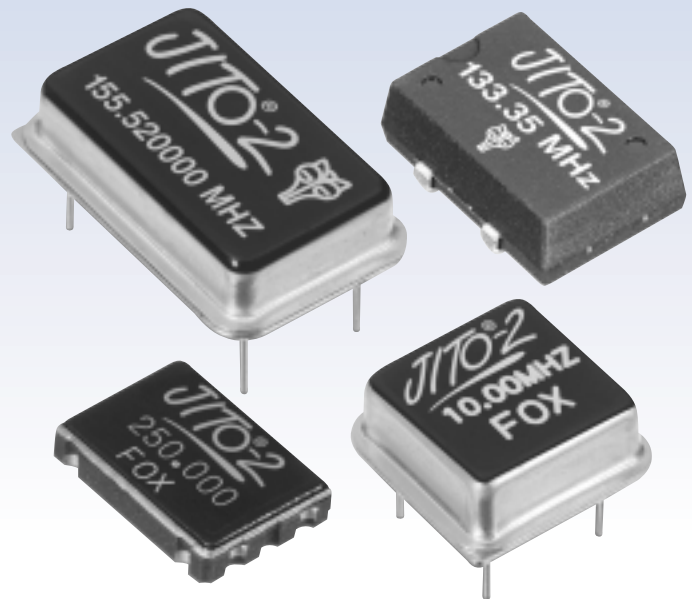

JITO[®]-2

JUST-IN-TIME OSCILLATORS[®]



*Fox's Expanded Line of Custom and Standard
Frequency Oscillators...in Just Days.*

ISO-9001
Certified

FOX Electronics FOX4U.com

FOX...

Redefining Oscillator Delivery... Again!

For years, Fox has been ranked as America's preferred oscillator/crystal company...by both engineers and buyers. But we've never rested on our laurels. Fox continues to pioneer advances in crystal and oscillator technology, availability and technical support...from standard products to custom solutions. Now, Fox redefines oscillator delivery and scheduling flexibility.

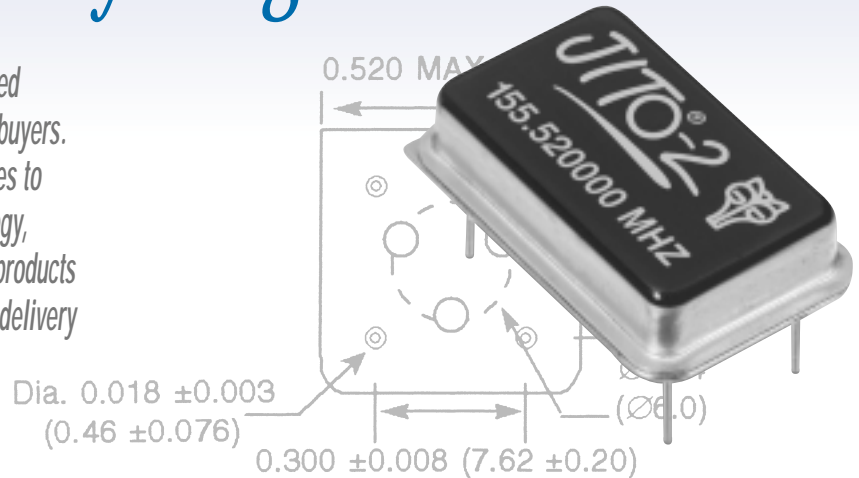

Meeting Today's Time-to-Market Pressures with JITO[®]-2 ... Just-In-Time Oscillators[®]: Custom and Standard Frequency Oscillators in Days!

The new JITO[®]-2 (Just-In-Time Oscillators[®]) line represents Fox's latest contribution to helping buyers and engineers alike meet the increasing pressure of bringing new designs and products to market faster and more efficiently. This new line of crystal oscillators cuts the industry standard lead time of 10 weeks down to just 10 business days or less for custom or standard frequency oscillators.

JITO[®]-2 represents the latest Fox response to urgent marketplace pressures. Engineers need custom frequencies as quickly as possible to test and prove their prototypes. Production people need to know that custom frequency products can be accessed quickly without holding up their line. And buyers have to ensure they can satisfy both engineering and production needs. The JITO[®]-2 line provides a total solution to those requirements by cutting industry standard lead times by an average of 90%.

JITO[®]-2 today...and tomorrow

Fox's current JITO[®]-2 line is offered in the following ranges:

- Custom and standard frequencies from 340 kHz up to 250 MHz
- 100, 50, 30, 25 PPM stability
- 3.3 or 5 volts; -20 to +70°C or -40 to +85°C operating range
- Both SMD and thru-hole packaging available
- Fox quality built-in
- Total technical support from the industry leader
- Reduced Phase Jitter - 1/3 that of competitive units

Meeting Today's Build-to-Order (BTO) Flexible Scheduling Needs

The ability to provide custom and standard frequency oscillators in days rather than weeks translates to tremendous benefits in terms of production scheduling flexibility. Only Fox's JITO[®]-2 program provides all this:

- Changes in orders allowed up to ship date
- Flexibility to cancel orders up to 10 days prior to ship date at no cost
- Unlimited upside order flexibility
- Samples and prototypes shipped immediately

These JITO[®]-2 advantages yield increased user benefits, including:

- No stocking or forecasting required
- JIT scheduling flexibility
- Ideal for build-to-order manufacturing
- No part shortages
- Streamlined inventory handling and control

In every respect, JITO[®]-2 lets you get to market faster and more efficiently than ever before.

JITO[®]-2 is Fox's answer to the phenomenal response we received from engineers and buyers to our initial JITO[®] program. The much-expanded and enhanced line features a wider range of frequencies, stabilities, operating temperatures and packages, plus greater flexibility in specification changing and scheduling. As JITO[®]-2 expands, we'll post product information on our website; www.foxonline.com. Check it, contact your local Fox representative, or call direct, 888-GET-2-FOX.

JITO[®]-2 Specifications

ELECTRICAL CHARACTERISTICS (C_L = Max Load)

PARAMETERS	FREQUENCY RANGE	CONDITIONS	MIN	MAX	UNITS
Frequency Range (Fo)			0.340	250.000	MHZ
Frequency Stability	0.340 ~ 250.000	All Conditions*	-100 -50 -30 -25	+100 +50 +30*** +25***	PPM
Temperature Range Operating (TOPR)	0.340 ~ 250.000		-20 -40	+70 +85	°C
Storage (TSTG)			-55	+125	
Supply Voltage (VDD)	0.340 ~ 250.000		+4.5 +3.0	+5.5 +3.6	V
Input Current**	0.340 ~ 25.000	VDD = 5.0V Max Load (HCMOS)		15	mA
	25.000+ ~ 50.000			20	
	50.000+ ~ 150.000			33	
	150.000+ ~ 250.000			55	
	0.340 ~ 250.000	VDD = 5.0V PECL		55	
	0.340 ~ 25.000	VDD = 3.3V Max Load (HCMOS)		8	
	25.000+ ~ 50.000			11	
	50.000+ ~ 150.000			21	
	150.000+ ~ 250.000			30	
	0.340 ~ 250.000	VDD = 3.3V PECL		30	
Output Symmetry	0.340 ~ 250.000	50% VDD Level HCMOS	45	55	%
		50% Vp-p Level PECL	40	60	
Rise Time	0.340 ~ 250.000	10% ~ 90% VDD Level HCMOS		5	nS
		20% ~ 80% Vp-p Level PECL		2	
Fall Time	0.340 ~ 250.000	90% ~ 10% VDD Level HCMOS		5	
		80% ~ 20% Vp-p Level PECL		2	
Output Voltage	0.340 ~ 250.000	VDD = 5.0V +/- -10% IOL = 4mA		10%VDD	V
		IOH = -4mA	90%VDD		
	0.340 ~ 250.000	VDD = 3.3V +/- -10% IOL = 2mA		10%VDD	
		IOH = -2mA	90%VDD	65%VDD	
Output Current	0.340 ~ 250.000	VDD = 5.0V +/- -10% VOL = 10%VDD VOH = 90% VDD		4 -4	mA
		VDD = 3.3V +/- -10% VOL = 10%VDD VOH = 90%VDD		2 -2	
Output Load	0.340 ~ 100.000	VDD = 5.0V +/- -10% (HCMOS)		25	pF
	100.000+ ~ 250.000			10	
	0.340 ~ 100.000		VDD = 3.3V +/- -10% (HCMOS)		
	100.000+ ~ 250.000			10	
Start-up Time (Ts)	0.340 ~ 250.000			10	mS
Enable/Disable Time** (JITO [®] -2 P) (JITO [®] -2 D)	0.340 ~ 250.000			100	nS
Output Skew (PECL)	0.340 ~ 250.000	50% Vp-p		500	pS

*Inclusive of 25°C tolerance, operating temperature range, input voltage change, load change, aging, shock and vibration.

** Stand by current (3.3V) = 60µA (MAX)

** Stand by enable time = 10mS (MAX)

***Available for -20°C ~ +70°C temperature range only.

All specifications subject to change without notice.

Covered by U.S. Patents 5,952,890
and 5,960,405.

Covered by one or more listed
Foreign Patents: R.S.A. 98/0866.

JITO[®]-2
JUST-IN-TIME OSCILLATORS[®]

ENABLE/DISABLE FUNCTION

PIN 1	Output
	MIN-6: Pins 4&2 (PECL) JITO [®] -2 P: Pin 3
OPEN	ACTIVE
'1' Level VIH ≥ 70%VDD	ACTIVE
'0' Level VIL ≤ 30%VDD	High Z

www.DataSheet4U.com

JITO[®]-2 . Only from Fox Electronics. Because in this business, timing is everything.

FULL SIZE 14 PIN DIP

Pin Connections
#1 N.C. #8 Output
#7 GND #14 VDD

Package
A

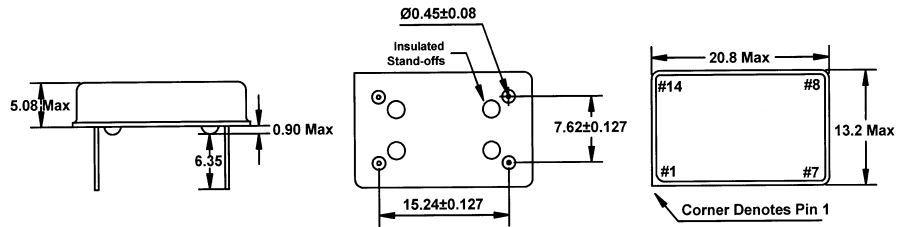

HALF SIZE 8 PIN DIP

Pin Connections
#1 N.C. #5 Output
#4 GND #8 VDD

Package
B

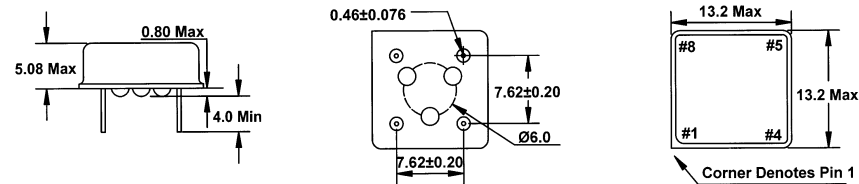

MIN-6 SMD

Pin Connections
#1 E/D #6 VDD
#2 N.C. or Out2 #5 N.C.
#3 GND #4 Output

Package
D

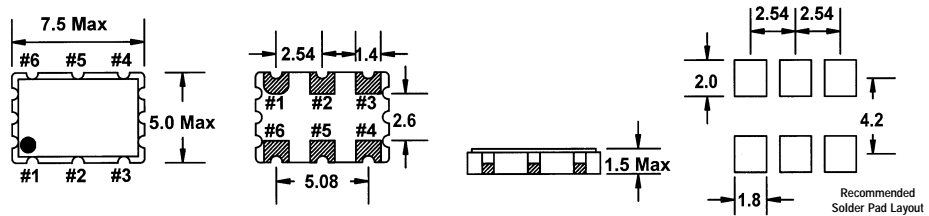

JITO®-2P

Pin Connections
#1 E/D #2 GND
#3 Output #4 VDD

Package
P

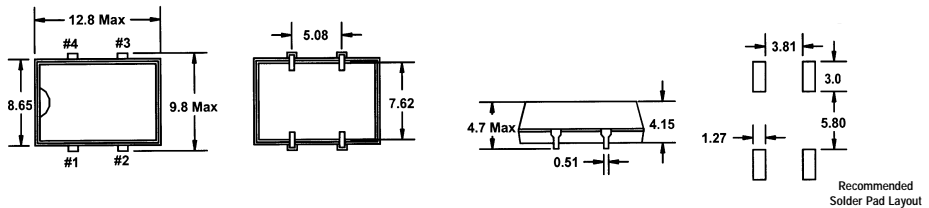

SMD Packaging – Tape & Reel Specifications (in millimeters)

Tape Specifications (millimeters)

Model	A	B	C	D	E	F
JITO®-2D	Ø1.5	4.0	8.0	7.5	16.0	2.15
JITO®-2P	Ø1.5	4.0	12.0	11.5	24.0	5.2
JITO®-2A	Shipped in tubes of 25 only.					
JITO®-2B	Shipped in tubes of 40 only.					

Reel Specifications (millimeters)

Model	G	H	I	J	K	L	M
JITO®-2D	2.0	Ø13	Ø21	Ø80	Ø2.50	17.5	2.0
JITO®-2P	2.0	Ø13	Ø21	Ø80	Ø330	25.5	2.0
JITO®-2A	Shipped in tubes of 25 only.						
JITO®-2B	Shipped in tubes of 40 only.						

JITO®-2D Standard quantity is 2,000. JITO®-2P Standard quantity is 1,000.

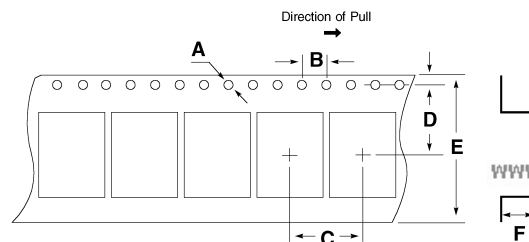
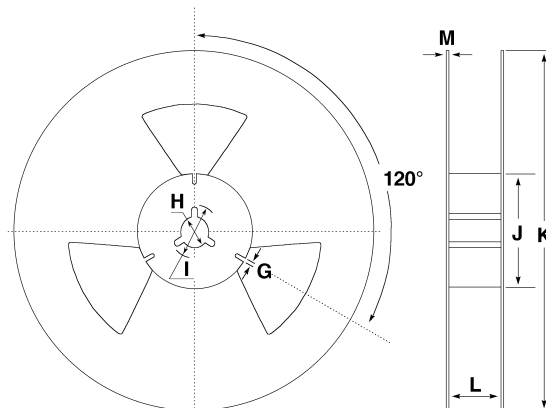

The JITO[®]-2 Phase Jitter Advantage

Phase Jitter has long been recognized as one of the most critical and defining parameters in the design and application of oscillators. Fox JITO[®]-2 Just-In-Time Oscillators[®] meet the need for more tightly controlled phase jitter. As detailed in the technical data below, JITO[®]-2 oscillators offer a 67% reduction in phase jitter over competitive programmed oscillators. And in certain frequency bands, the phase jitter characteristics of our JITO[®]-2 oscillators compare favorably to fixed frequency oscillators.

The dramatically reduced phase jitter of Fox JITO[®]-2 oscillators can make your systems less prone to the introduction of bit errors with microprocessors and increase the reliability of any data sensitive application.

If phase jitter is a critical specification for your application, specify JITO[®]-2 to be sure.

JITO[®]-2 PECL Test Circuit (below) and HCMOS Test Circuit (bottom).

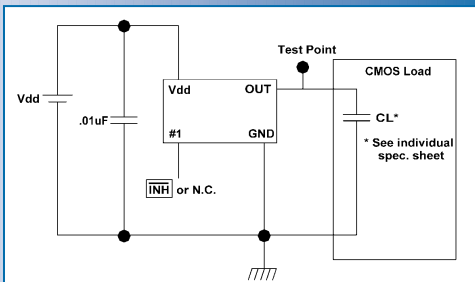
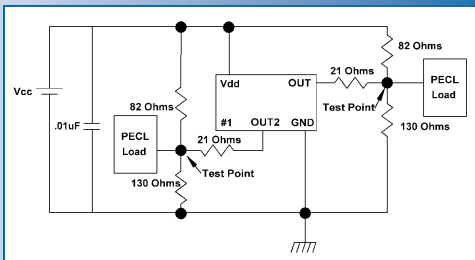

Phase Jitter Measurements at Fox Electronics

Cycle to Cycle Phase Jitter measurements on our JITO[®]-2 oscillators are performed with a Tektronix TDS 784C Digital Oscilloscope using the histogram function.

With the trigger set at the midpoint of the rising edge, a histogram of the horizontal deviation of the first rising edge from the trigger point is constructed. The peak to peak distribution and standard deviation (Sigma or RMS) is derived from this histogram. This is the "measured" cycle to cycle phase jitter, peak to peak and RMS. The same measurement is then taken at the trigger point to determine "trigger phase jitter" (typically 60 ~ 80pS p-p/10 ~ 13pS RMS). The trigger phase jitter is then subtracted from the measured phase jitter one cycle out to determine cycle to cycle phase jitter, peak to peak and RMS. Typical phase jitter measurements listed here are based on subtracting the lesser, 60pS p-p/10pS RMS, value from all measured values.

Typical phase jitter values for the frequency range of 50MHz ~ 250MHz are listed below:

Frequency (MHz)	Supply Voltage	p-p Jitter	RMS Jitter
50	3.3	160	26
	5.0	100	16
100	3.3	80	13
	5.0	60	10
125	3.3	60	10
	5.0	60	10
150	3.3	80	13
	5.0	80	13
250	3.3	60	10
	5.0	40	6

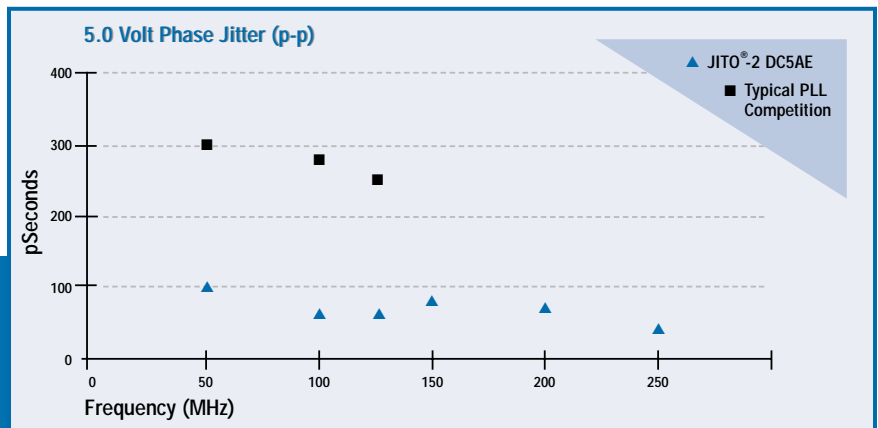

JITO[®]-2 Typical Input Current (mA)

Frequency (MHz):	16.000	50.000	100.000	125.000	150.000	250.000
Typical Competitor	11.9	18.0	28.5	30.1	n.a.	n.a.
JITO [®] -2 @ 5.0v Vdd	9.4	13.7	20.0	21.2	24.8	42.3
JITO [®] -2 @ 3.3v Vdd	6.2	7.8	12.3	12.9	15.0	25.0



JITO[®]-2 ORDERING INFORMATION

Use the part description guide below to order the JITO[®]-2 Oscillator you need:

JITO[®]-2 PART DESCRIPTION GUIDE

JITO[®]-2 - B C 3 A M C - 106.250000

Frequency (MHz)

C = Custom
(or leave blank)

Package Style:

A = 14 Pin DIP
B = 8 Pin DIP
D = MIN-6 (5x7.5x1.5mm
6 Pad SMD)
P = Plastic
(10x13x5mm)

Type:

C = HCMOS
P = PECL
S = HCMOS
(Standby)

Supply Voltage:

5 = +5.0V
3 = +3.3V

Stability:

A = ±100ppm
B = ±50ppm
C = ±30ppm**
D = ±25ppm**

Temperature Range:

E = -10°C to +70°C
F = -20°C to +70°C
M = -40°C to +85°C

If you need assistance in selecting the proper JITO[®]-2 oscillator for your specific application, Fox's skilled technical support team will be glad to assist you. Just call us.

** Check availability of C and D stability with M temperature range

JITO[®]-T: (Thru-Hole, Dual Output PECL, Tri-State) Ask your Customer Service Representative for details.

OTHER FOX FREQUENCY CONTROL PRODUCTS

The JITO[®]-2 series represents just a portion of the broad spectrum of frequency control products and solutions available from Fox, including:

Quartz Crystals: Frequencies from 32.768 kHz to 200 MHz, standard and custom; stabilities to 5 PPM.

Oscillators: Frequencies from 340 kHz to 250 MHz, standard and custom; stabilities from 20 PPM to 100 PPM.

TCXOs/VCXOs: High performance temperature- and voltage-controlled oscillators; frequencies from 1 MHz to 40 MHz.

Crystal Filters: Frequencies from 10.7 MHz to 90 MHz.

All Fox frequency control products are 100% tested, offered in a variety of surface mount and thru-hole configurations, and are available directly from Fox or off the shelves of our very well stocked national distribution network.

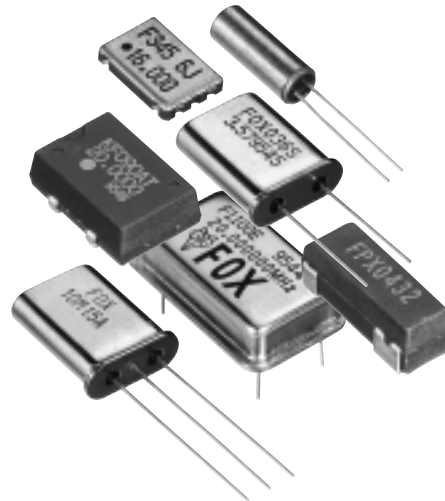

FOX Electronics

We're On Your Frequency.

5570 Enterprise Parkway
Fort Myers, FL 33905
Tel: **888-GET-2-FOX**
Fax: 941-693-1554

When it comes to frequency control, why trust your products to anyone less than Fox? It always pays to go with the leader. Call, fax or visit us on the web today.

www.foxonline.com

FX-3249-600-10M-FP
Revised June 2000