

ELCO  
Torson 1.27mm (.050")  
Board to Board Connectors

**Features & Benefits** ..... 2

**Product Selection Guide** ..... 3

	<b>Description</b>	<b>Part No.</b>	<b>Page</b>
<b>Receptacles</b>			
Standard Profile. . . . .	Horizontal Through-Hole Mount, Right Angle. . . . .	20-5016-2XXX-20-001	4
Standard Profile. . . . .	Vertical Through-Hole Mount. . . . .	20-5016-2XXX-10-001	5
Standard Profile. . . . .	Vertical Surface Mount . . . . .	21-5016-2XXX-10-001	6
Low Profile . . . . .	Vertical Through-Hole Mount. . . . .	22-5016-2XXX-10-001	7
Low Profile . . . . .	Vertical Surface Mount . . . . .	23-5016-2XXX-10-001	8
Low Profile . . . . .	Vertical Bottom Entry, Surface Mount . . . . .	24-5016-2XXX-10-001	9

<b>Headers</b>			
Standard Profile. . . . .	Vertical Through-Hole Mount. . . . .	10-5016-2XXX-10-001	10
Standard Profile. . . . .	Vertical Surface Mount . . . . .	11-5016-2XXX-10-001	11
Low Profile . . . . .	Vertical Through-Hole Mount. . . . .	12-5016-2XXX-10-001	12
Ultra Low Profile . . . . .	Vertical Surface Mount . . . . .	17-5016-2XXX-10-001	13
Pin Carrier Low Profile. . . . .	Vertical Through-Hole Mount. . . . .	15-5016-2XXX-10-002	14

**Product Specifications/Solder Temperature Reflow Profile** ..... 15

## Features & Benefits

---

- High speed pick and place packaging available
- Low profile
- Plastic contact lead-in for ease of insertion
- Early and long contact wipe
- Two-piece interconnection system for high reliability
- Low insertion force and high normal force contacts for large number of pin-outs and interface reliability
- High temperature insulation material that can accommodate reflow soldering temperatures

### APPLICATIONS

Data - Computers, Hard Disk Drives

Telecommunications - Mobile Phones, Pagers

Medical

Hand-held Equipment

### Board to Board

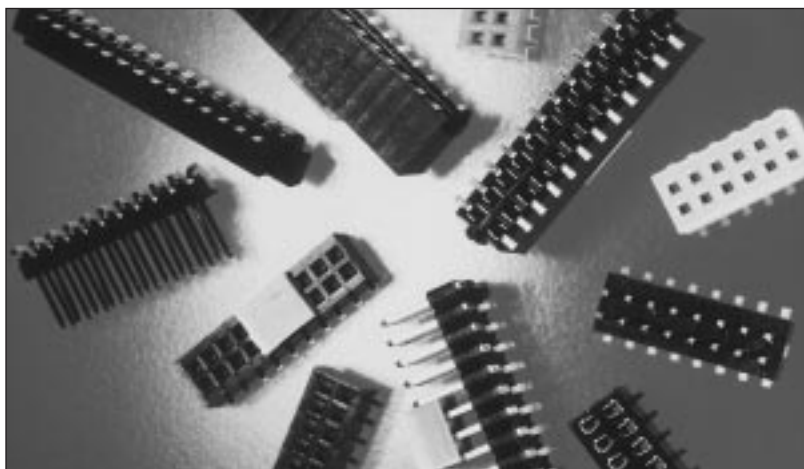

Part No.	Description	Board/Board Stacking Height	Page
24-5016	Receptacle: SMT	1.52	9
12-5016	Header: Through-Hole		12
22-5016	Receptacle: Through-Hole	2.21	7
15-5016	Header: Pin Carrier		14
23-5016	Receptacle: SMT	2.21	8
15-5016	Header: Pin Carrier		14
22-5016	Receptacle: Through-Hole	3.73	7
12-5016	Header: Through-Hole		12
23-5016	Receptacle: SMT	3.73	8
12-5016	Header: Through-Hole		12
23-5016	Receptacle: SMT	4.28	8
17-5016	Header: SMT		13
22-5016	Receptacle: Through-Hole	4.28	7
17-5016	Header: SMT		13
21-5016	Receptacle: SMT	6.09	6
10-5016	Header: Through-Hole		10
20-5016-2XXX-10	Receptacle: Through-Hole	6.09	5
10-5016	Header: Through-Hole		10
20-5016-2XXX-10	Receptacle: Through-Hole	6.73	5
11-5016	Header: SMT		11
21-5016	Receptacle: SMT	6.73	6
11-5016	Header: SMT		11

# Torson 0.050" 1.27mm



## 20-5016-2XXX-20-001 – Receptacle - Right Angle

Part Number			No. of Positions	A	B	C Max.	Qty. Per Tube
20 5016 2004 20 001	4	1	1.27 (0.050)	2.84 (0.112)	200		
↑ ↑ 2006 ↑ ↑	6	2	2.54 (0.100)	4.11 (0.162)	138		
2008	8	3	3.81 (0.150)	5.38 (0.212)	105		
2010	10	4	5.08 (0.200)	6.65 (0.262)	85		
2012	12	5	6.35 (0.250)	7.92 (0.312)	71		
2014	14	6	7.62 (0.300)	9.19 (0.362)	62		
2016	16	7	8.89 (0.350)	10.46 (0.412)	54		
2018	18	8	10.16 (0.400)	11.73 (0.462)	48		
2020	20	9	11.43 (0.450)	13.00 (0.512)	43		
2022	22	10	12.70 (0.500)	14.27 (0.562)	39		
2024	24	11	13.97 (0.550)	15.54 (0.612)	36		
2026	26	12	15.24 (0.600)	16.81 (0.662)	33		
2028	28	13	16.51 (0.650)	18.08 (0.712)	31		
2030	30	14	17.78 (0.700)	19.35 (0.762)	29		
2032	32	15	19.05 (0.750)	20.62 (0.812)	27		
2034	34	16	20.32 (0.800)	21.89 (0.862)	26		
2036	36	17	21.59 (0.850)	23.16 (0.912)	24		
2038	38	18	22.86 (0.900)	24.43 (0.962)	23		
2040	40	19	24.13 (0.950)	25.70 (1.012)	22		
2042	42	20	25.40 (1.000)	26.97 (1.062)	21		
2044	44	21	26.67 (1.050)	28.24 (1.112)	20		
2046	46	22	27.94 (1.100)	29.51 (1.162)	19		
↓ ↓ 2048 ↓ ↓	48	23	29.21 (1.150)	30.78 (1.212)	18		
20 5016 2050 20 001	50	24	30.48 (1.200)	32.05 (1.262)	17		
20 5016 2052 20 001	52	25	31.75 (1.250)	33.32 (1.312)	17		
↑ ↑ 2054 ↑ ↑	54	26	33.02 (1.300)	34.59 (1.362)	16		
2056	56	27	34.29 (1.350)	35.86 (1.412)	15		
2058	58	28	35.56 (1.400)	37.13 (1.462)	15		
2060	60	29	36.83 (1.450)	38.40 (1.512)	14		
2062	62	30	38.10 (1.500)	39.67 (1.562)	14		
2064	64	31	39.37 (1.550)	40.94 (1.612)	13		
2066	66	32	40.64 (1.600)	42.21 (1.662)	13		
2068	68	33	41.91 (1.650)	43.48 (1.712)	13		
2070	70	34	43.18 (1.700)	44.75 (1.762)	12		
2072	72	35	44.45 (1.750)	46.02 (1.812)	12		
2074	74	36	45.72 (1.800)	47.29 (1.862)	12		
2076	76	37	46.99 (1.850)	48.56 (1.912)	11		
2078	78	38	48.26 (1.900)	49.83 (1.962)	11		
2080	80	39	49.53 (1.950)	51.10 (2.012)	11		
2082	82	40	50.80 (2.000)	52.37 (2.062)	10		
2084	84	41	52.07 (2.050)	53.64 (2.112)	10		
2086	86	42	53.34 (2.100)	54.91 (2.162)	10		
2088	88	43	54.61 (2.150)	56.18 (2.212)	10		
2090	90	44	55.88 (2.200)	57.45 (2.262)	9		
2092	92	45	57.15 (2.250)	58.72 (2.312)	9		
2094	94	46	58.42 (2.300)	59.99 (2.362)	9		
2096	96	47	59.69 (2.350)	61.26 (2.412)	9		
2098	98	48	60.96 (2.400)	62.53 (2.462)	9		
↓ ↓ 2100 ↓ ↓	100	49	62.23 (2.450)	63.80 (2.512)	8		
20 5016 2102 20 001	102	50	63.50 (2.500)	65.07 (2.562)	8		

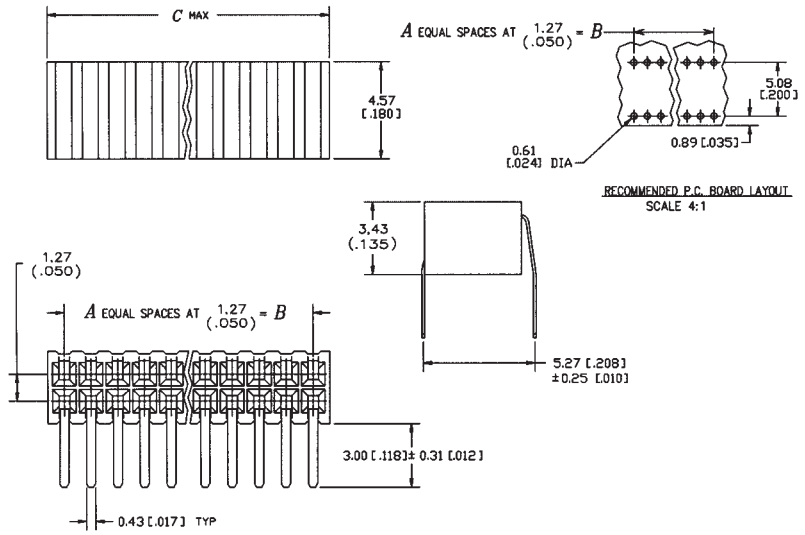

### Specifications

- Insulator Material – High temperature thermoplastic (UL 94 V-O)
- Contact Material – copper alloy
- Contact Plating – .000030–.000080 (0.00076–0.00203) nickel underplate all over  
.000015 (0.00038) min. gold in mating area  
.000075–.000150 (0.00191–0.00381) tin/lead on tails

### ORDERING CODE

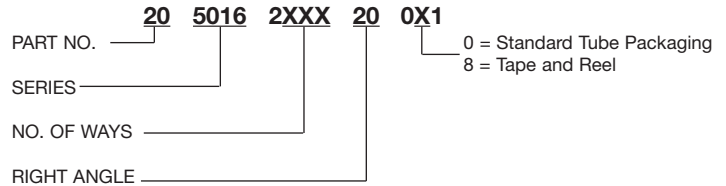

# Torson 0.050" 1.27mm



## 20-5016-2XXX-10-001 – Receptacle - Straight

Part Number			No. of Positions	A	B	C Max.	Qty. Per Tube
20 5016 2004	10 001		4	1	1.27 (0.050)	2.84 (0.112)	200
↑ ↑	2006	↑ ↑	6	2	2.54 (0.100)	4.11 (0.162)	138
	2008		8	3	3.81 (0.150)	5.38 (0.212)	105
	2010		10	4	5.08 (0.200)	6.65 (0.262)	85
	2012		12	5	6.35 (0.250)	7.92 (0.312)	71
	2014		14	6	7.62 (0.300)	9.19 (0.362)	62
	2016		16	7	8.89 (0.350)	10.46 (0.412)	54
	2018		18	8	10.16 (0.400)	11.73 (0.462)	48
	2020		20	9	11.43 (0.450)	13.00 (0.512)	43
	2022		22	10	12.70 (0.500)	14.27 (0.562)	39
	2024		24	11	13.97 (0.550)	15.54 (0.612)	36
	2026		26	12	15.24 (0.600)	16.81 (0.662)	33
	2028		28	13	16.51 (0.650)	18.08 (0.712)	31
	2030		30	14	17.78 (0.700)	19.35 (0.762)	29
	2032		32	15	19.05 (0.750)	20.62 (0.812)	27
	2034		34	16	20.32 (0.800)	21.89 (0.862)	26
	2036		36	17	21.59 (0.850)	23.16 (0.912)	24
	2038		38	18	22.86 (0.900)	24.43 (0.962)	23
	2040		40	19	24.13 (0.950)	25.70 (1.012)	22
	2042		42	20	25.40 (1.000)	26.97 (1.062)	21
	2044		44	21	26.67 (1.050)	28.24 (1.112)	20
	2046		46	22	27.94 (1.100)	29.51 (1.162)	19
↓ ↓	2048	↓ ↓	48	23	29.21 (1.150)	30.78 (1.212)	18
20 5016 2050	10 001		50	24	30.48 (1.200)	32.05 (1.262)	17
20 5016 2052	10 001		52	25	31.75 (1.250)	33.32 (1.312)	17
↑ ↑	2054	↑ ↑	54	26	33.02 (1.300)	34.59 (1.362)	16
	2056		56	27	34.29 (1.350)	35.86 (1.412)	15
	2058		58	28	35.56 (1.400)	37.13 (1.462)	15
	2060		60	29	36.83 (1.450)	38.40 (1.512)	14
	2062		62	30	38.10 (1.500)	39.67 (1.562)	14
	2064		64	31	39.37 (1.550)	40.94 (1.612)	13
	2066		66	32	40.64 (1.600)	42.21 (1.662)	13
	2068		68	33	41.91 (1.650)	43.48 (1.712)	13
	2070		70	34	43.18 (1.700)	44.75 (1.762)	12
	2072		72	35	44.45 (1.750)	46.02 (1.812)	12
	2074		74	36	45.72 (1.800)	47.29 (1.862)	12
	2076		76	37	46.99 (1.850)	48.56 (1.912)	11
	2078		78	38	48.26 (1.900)	49.83 (1.962)	11
	2080		80	39	49.53 (1.950)	51.10 (2.012)	11
	2082		82	40	50.80 (2.000)	52.37 (2.062)	10
	2084		84	41	52.07 (2.050)	53.64 (2.112)	10
	2086		86	42	53.34 (2.100)	54.91 (2.162)	10
	2088		88	43	54.61 (2.150)	56.18 (2.212)	10
	2090		90	44	55.88 (2.200)	57.45 (2.262)	9
	2092		92	45	57.15 (2.250)	58.72 (2.312)	9
	2094		94	46	58.42 (2.300)	59.99 (2.362)	9
	2096		96	47	59.69 (2.350)	61.26 (2.412)	9
	2098		98	48	60.96 (2.400)	62.53 (2.462)	9
↓ ↓	2100	↓ ↓	100	49	62.23 (2.450)	63.80 (2.512)	8
20 5016 2102	10 001		102	50	63.50 (2.500)	65.07 (2.562)	8

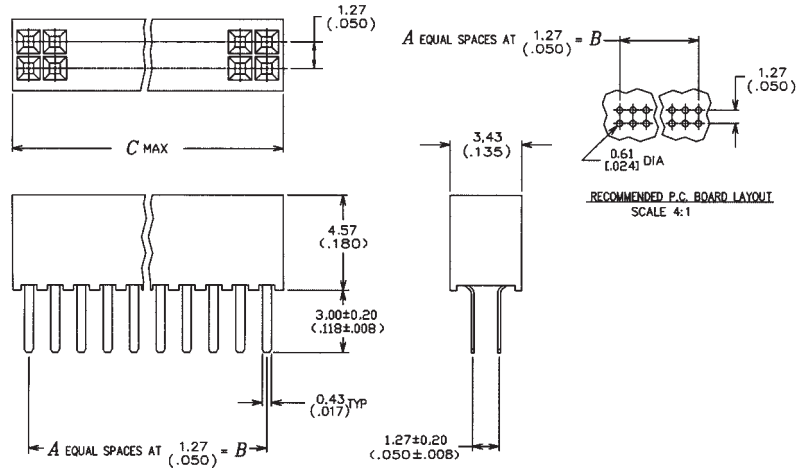

### Specifications

- Insulator Material – High temperature thermoplastic (UL 94 V-O)
- Contact Material – copper alloy
- Contact Plating – .000030-.000080 (0.00076-0.00203) nickel underplate all over  
.000015 (0.00038) min. gold in mating area  
.000075-.000150 (0.00191-0.00381) tin/lead on tails

### Mating Half

Part Number	Board/Board Stacking Height	See Page
20-5016-2XXX-10-001	6.09	5
10-5016-2XXX-10-001		10
20-5016-2XXX-10-001	6.73	5
11-5016-2XXX-10-001		11

### ORDERING CODE

PART NO. 20 5016 2XXX 10 0X1  
 SERIES \_\_\_\_\_  
 NO. OF WAYS \_\_\_\_\_

0 = Standard Tube Packaging  
 8 = Tape and Reel

# Torson 0.050" 1.27mm



## 21-5016-2XXX-10-001 – Receptacle

Part Number			No. of Positions	A	B	C Max.	Qty. Per Tube
21 5016	2004	10 001	4	1	1.27 (0.050)	2.84 (0.112)	200
↑	↑	2006	↑	↑	2.54 (0.100)	4.11 (0.162)	138
		2008	8	3	3.81 (0.150)	5.38 (0.212)	105
		2010	10	4	5.08 (0.200)	6.65 (0.262)	85
		2012	12	5	6.35 (0.250)	7.92 (0.312)	71
		2014	14	6	7.62 (0.300)	9.19 (0.362)	62
		2016	16	7	8.89 (0.350)	10.46 (0.412)	54
		2018	18	8	10.16 (0.400)	11.73 (0.462)	48
		2020	20	9	11.43 (0.450)	13.00 (0.512)	43
		2022	22	10	12.70 (0.500)	14.27 (0.562)	39
		2024	24	11	13.97 (0.550)	15.54 (0.612)	36
		2026	26	12	15.24 (0.600)	16.81 (0.662)	33
		2028	28	13	16.51 (0.650)	18.08 (0.712)	31
		2030	30	14	17.78 (0.700)	19.35 (0.762)	29
		2032	32	15	19.05 (0.750)	20.62 (0.812)	27
		2034	34	16	20.32 (0.800)	21.89 (0.862)	26
		2036	36	17	21.59 (0.850)	23.16 (0.912)	24
		2038	38	18	22.86 (0.900)	24.43 (0.962)	23
		2040	40	19	24.13 (0.950)	25.70 (1.012)	22
		2042	42	20	25.40 (1.000)	26.97 (1.062)	21
		2044	44	21	26.67 (1.050)	28.24 (1.112)	20
		2046	46	22	27.94 (1.100)	29.51 (1.162)	19
		2048	48	23	29.21 (1.150)	30.78 (1.212)	18
21 5016	2050	10 001	50	24	30.48 (1.200)	32.05 (1.262)	17
21 5016	2052	10 001	52	25	31.75 (1.250)	33.32 (1.312)	17
↑	↑	2054	↑	↑	33.02 (1.300)	34.59 (1.362)	16
		2056	56	27	34.29 (1.350)	35.86 (1.412)	15
		2058	58	28	35.56 (1.400)	37.13 (1.462)	15
		2060	60	29	36.83 (1.450)	38.40 (1.512)	14
		2062	62	30	38.10 (1.500)	39.67 (1.562)	14
		2064	64	31	39.37 (1.550)	40.94 (1.612)	13
		2066	66	32	40.64 (1.600)	42.21 (1.662)	13
		2068	68	33	41.91 (1.650)	43.48 (1.712)	13
		2070	70	34	43.18 (1.700)	44.75 (1.762)	12
		2072	72	35	44.45 (1.750)	46.02 (1.812)	12
		2074	74	36	45.72 (1.800)	47.29 (1.862)	12
		2076	76	37	46.99 (1.850)	48.56 (1.912)	11
		2078	78	38	48.26 (1.900)	49.83 (1.962)	11
		2080	80	39	49.53 (1.950)	51.10 (2.012)	11
		2082	82	40	50.80 (2.000)	52.37 (2.062)	10
		2084	84	41	52.07 (2.050)	53.64 (2.112)	10
		2086	86	42	53.34 (2.100)	54.91 (2.162)	10
		2088	88	43	54.61 (2.150)	56.18 (2.212)	10
		2090	90	44	55.88 (2.200)	57.45 (2.262)	9
		2092	92	45	57.15 (2.250)	58.72 (2.312)	9
		2094	94	46	58.42 (2.300)	59.99 (2.362)	9
		2096	96	47	59.69 (2.350)	61.26 (2.412)	9
		2098	98	48	60.96 (2.400)	62.53 (2.462)	9
		2100	100	49	62.23 (2.450)	63.80 (2.512)	8
21 5016	2102	10 001	102	50	63.50 (2.500)	65.07 (2.562)	8

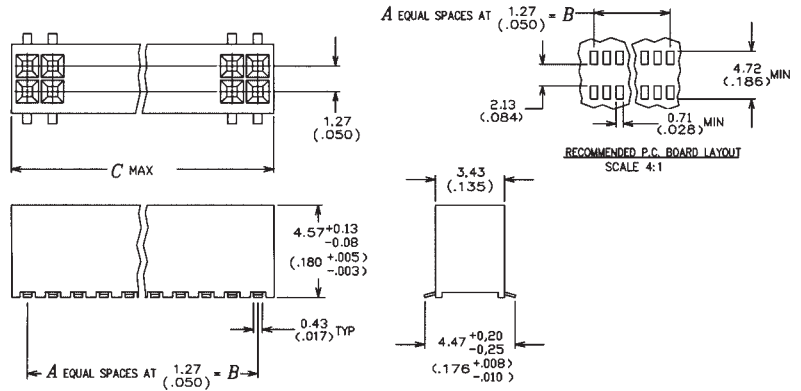

### Specifications

- Insulator Material – High temperature thermoplastic (UL 94 V-O)
- Contact Material – copper alloy
- Contact Plating – .000030-.000080 (0.00076-0.00203) nickel underplate all over  
.000015 (0.00038) min. gold in mating area  
.000075-.000150 (0.00191-0.00381) tin/lead on tails

### Mating Half

Part Number	Board/Board Stacking Height	See Page
11-5016-2XXX-10-001	6.73	11
20-5016-2XXX-10-001		5
11-5016-2XXX-10-001	6.73	11
21-5016-2XXX-10-001		6

### ORDERING CODE

PART NO. 21 5016 2XXX 10 0X1  
 SERIES \_\_\_\_\_  
 NO. OF WAYS \_\_\_\_\_

0 = Standard Tube Packaging  
 8 = Tape and Reel

# Torson 0.050" 1.27mm



## 22-5016-2XXX-10-001 – Receptacle

Part Number			No. of Positions	A	B	C Max.	Qty. Per Tube
22 5016	2002	10 001	4	1	1.27 (0.050)	2.84 (0.112)	200
↑	↑	2003	6	2	2.54 (0.100)	4.11 (0.162)	138
		2004	8	3	3.81 (0.150)	5.38 (0.212)	105
		2005	10	4	5.08 (0.200)	6.65 (0.262)	85
		2006	12	5	6.35 (0.250)	7.92 (0.312)	71
		2007	14	6	7.62 (0.300)	9.19 (0.362)	62
		2008	16	7	8.89 (0.350)	10.46 (0.412)	54
		2009	18	8	10.16 (0.400)	11.73 (0.462)	48
		2010	20	9	11.43 (0.450)	13.00 (0.512)	43
		2011	22	10	12.70 (0.500)	14.27 (0.562)	39
		2012	24	11	13.97 (0.550)	15.54 (0.612)	36
		2013	26	12	15.24 (0.600)	16.81 (0.662)	33
		2014	28	13	16.51 (0.650)	18.08 (0.712)	31
		2015	30	14	17.78 (0.700)	19.35 (0.762)	29
		2016	32	15	19.05 (0.750)	20.62 (0.812)	27
		2017	34	16	20.32 (0.800)	21.89 (0.862)	26
		2018	36	17	21.59 (0.850)	23.16 (0.912)	24
		2019	38	18	22.86 (0.900)	24.43 (0.962)	23
		2020	40	19	24.13 (0.950)	25.7084 (1.012)	22
		2021	42	20	25.40 (1.000)	26.97 (1.062)	21
		2022	44	21	26.67 (1.050)	28.24 (1.112)	20
		2023	46	22	27.94 (1.100)	29.51 (1.162)	19
		2024	48	23	29.21 (1.150)	30.78 (1.212)	18
22 5016	2025	10 001	50	24	30.48 (1.200)	32.05 (1.262)	17
22 5016	2026	10 001	52	25	31.75 (1.250)	33.32 (1.312)	17
↑	↑	2027	54	26	33.02 (1.300)	34.59 (1.362)	16
		2028	56	27	34.29 (1.350)	35.86 (1.412)	15
		2029	58	28	35.56 (1.400)	37.13 (1.462)	15
		2030	60	29	36.83 (1.450)	38.40 (1.512)	14
		2031	62	30	38.10 (1.500)	39.67 (1.562)	14
		2032	64	31	39.37 (1.550)	40.94 (1.612)	13
		2033	66	32	40.64 (1.600)	42.21 (1.662)	13
		2034	68	33	41.91 (1.650)	43.48 (1.712)	13
		2035	70	34	43.18 (1.700)	44.75 (1.762)	12
		2036	72	35	44.45 (1.750)	46.02 (1.812)	12
		2037	74	36	45.72 (1.800)	47.29 (1.862)	12
		2038	76	37	46.99 (1.850)	48.56 (1.912)	11
		2039	78	38	48.26 (1.900)	49.83 (1.962)	11
		2040	80	39	49.53 (1.950)	51.10 (2.012)	11
		2041	82	40	50.80 (2.000)	52.37 (2.062)	10
		2042	84	41	52.07 (2.050)	53.64 (2.112)	10
		2043	86	42	53.34 (2.100)	54.91 (2.162)	10
		2044	88	43	54.61 (2.150)	56.18 (2.212)	10
		2045	90	44	55.88 (2.200)	57.45 (2.262)	9
		2046	92	45	57.15 (2.250)	58.72 (2.312)	9
		2047	94	46	58.42 (2.300)	59.99 (2.362)	9
		2048	96	47	59.69 (2.350)	61.26 (2.412)	9
		2049	98	48	60.96 (2.400)	62.53 (2.462)	9
		2050	100	49	62.23 (2.450)	63.80 (2.512)	8
22 5016	2051	10 001	102	50	63.50 (2.500)	65.07 (2.562)	8

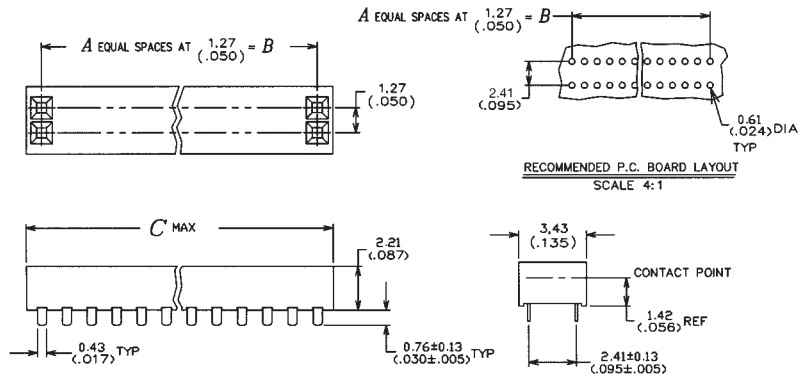

### Specifications

- Insulator Material – High temperature thermoplastic (UL 94 V-O)
- Contact Material – copper alloy
- Contact Plating – .000030-.000080 (0.00076-0.00203) nickel underplate all over  
.000015 (0.00038) min. gold in mating area  
.000075-.000150 (0.00191-0.00381) tin/lead on tails

### Mating Half

Part Number	Board/Board Stacking Height	See Page
22-5016-2XXX-10-001	3.73	7
12-5016-2XXX-10-001		12
22-5016-2XXX-10-001	2.21	7
15-5016-2XXX-10-002		14

### ORDERING CODE

**22 5016 2XXX 10 0X1**  
 PART NO. \_\_\_\_\_  
 SERIES \_\_\_\_\_  
 NUMBER X2 = NO. OF WAYS \_\_\_\_\_

0 = Standard Tube Packaging  
 8 = Tape and Reel



# Torson 0.050" 1.27mm



## 23-5016-2XXX-10-001 – Receptacle

Part Number	No. of Positions	A	B	C Max.	Qty. Per Tube
23 5016 2002 10 001	4	1	1.27 (0.050)	2.84 (0.112)	200
↑ ↑ 2003 ↑ ↑	6	2	2.54 (0.100)	4.11 (0.162)	138
2004	8	3	3.81 (0.150)	5.38 (0.212)	105
2005	10	4	5.08 (0.200)	6.65 (0.262)	85
2006	12	5	6.35 (0.250)	7.92 (0.312)	71
2007	14	6	7.62 (0.300)	9.19 (0.362)	62
2008	16	7	8.89 (0.350)	10.46 (0.412)	54
2009	18	8	10.16 (0.400)	11.73 (0.462)	48
2010	20	9	11.43 (0.450)	13.00 (0.512)	43
2011	22	10	12.70 (0.500)	14.27 (0.562)	39
2012	24	11	13.97 (0.550)	15.54 (0.612)	36
2013	26	12	15.24 (0.600)	16.81 (0.662)	33
2014	28	13	16.51 (0.650)	18.08 (0.712)	31
2015	30	14	17.78 (0.700)	19.35 (0.762)	29
2016	32	15	19.05 (0.750)	20.62 (0.812)	27
2017	34	16	20.32 (0.800)	21.89 (0.862)	26
2018	36	17	21.59 (0.850)	23.16 (0.912)	24
2019	38	18	22.86 (0.900)	24.43 (0.962)	23
2020	40	19	24.13 (0.950)	25.70 (1.012)	22
2021	42	20	25.40 (1.000)	26.97 (1.062)	21
2022	44	21	26.67 (1.050)	28.24 (1.112)	20
2023	46	22	27.94 (1.100)	29.51 (1.162)	19
↓ ↓ 2024 ↓ ↓	48	23	29.21 (1.150)	30.78 (1.212)	18
23 5016 2025 10 001	50	24	30.48 (1.200)	32.05 (1.262)	17
23 5016 2026 10 001	52	25	31.75 (1.250)	33.32 (1.312)	17
↑ ↑ 2027 ↑ ↑	54	26	33.02 (1.300)	34.59 (1.362)	16
2028	56	27	34.29 (1.350)	35.86 (1.412)	15
2029	58	28	35.56 (1.400)	37.13 (1.462)	15
2030	60	29	36.83 (1.450)	38.40 (1.512)	14
2031	62	30	38.10 (1.500)	39.67 (1.562)	14
2032	64	31	39.37 (1.550)	40.94 (1.612)	13
2033	66	32	40.64 (1.600)	42.21 (1.662)	13
2034	68	33	41.91 (1.650)	43.48 (1.712)	13
2035	70	34	43.18 (1.700)	44.75 (1.762)	12
2036	72	35	44.45 (1.750)	46.02 (1.812)	12
2037	74	36	45.72 (1.800)	47.29 (1.862)	12
2038	76	37	46.99 (1.850)	48.56 (1.912)	11
2039	78	38	48.26 (1.900)	49.83 (1.962)	11
2040	80	39	49.53 (1.950)	51.10 (2.012)	11
2041	82	40	50.80 (2.000)	52.37 (2.062)	10
2042	84	41	52.07 (2.050)	53.64 (2.112)	10
2043	86	42	53.34 (2.100)	54.91 (2.162)	10
2044	88	43	54.61 (2.150)	56.18 (2.212)	10
2045	90	44	55.88 (2.200)	57.45 (2.262)	9
2046	92	45	57.15 (2.250)	58.72 (2.312)	9
2047	94	46	58.42 (2.300)	59.99 (2.362)	9
2048	96	47	59.69 (2.350)	61.26 (2.412)	9
2049	98	48	60.96 (2.400)	62.53 (2.462)	9
↓ ↓ 2050 ↓ ↓	100	49	62.23 (2.450)	63.80 (2.512)	8
23 5016 2051 10 001	102	50	63.50 (2.500)	65.07 (2.562)	8

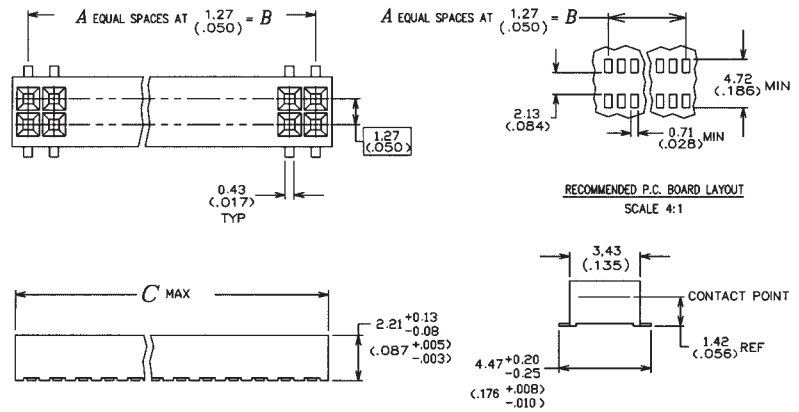

### Specifications

- Insulator Material – High temperature thermoplastic (UL 94 V-O)
- Contact Material – copper alloy
- Contact Plating – .000030-.000080 (0.00076-0.00203) nickel underplate all over  
.000015 (0.00038) min. gold in mating area  
.000075-.000150 (0.00191-0.00381) tin/lead on tails

### Mating Half

Part Number	Board/Board Stacking Height	See Page
23-5016-2XXX-10-001	2.21	8
15-5016-2XXX-10-002		14
23-5016-2XXX-10-001	3.73	8
12-5016-2XXX-10-001		12
23-5016-2XXX-10-001	4.28	8
17-5016-2XXX-10-001		13

### ORDERING CODE

23 5016 2XXX 10 0X1  
 PART NO. \_\_\_\_\_  
 SERIES \_\_\_\_\_  
 NUMBER X2 = NO. OF WAYS \_\_\_\_\_

0 = Standard Tube Packaging  
 8 = Tape and Reel

# Torson 0.050" 1.27mm



## 24-5016-2XXX-10-001 – Receptacle

Part Number	No. of Positions	A	B	C Max.	Qty. Per Tube
24 5016 2002 10 001	4	1	1.27 (0.050)	2.84 (0.112)	200
↑ ↑ 2003 ↑ ↑	6	2	2.54 (0.100)	4.11 (0.162)	138
2004	8	3	3.81 (0.150)	5.38 (0.212)	105
2005	10	4	5.08 (0.200)	6.65 (0.262)	85
2006	12	5	6.35 (0.250)	7.92 (0.312)	71
2007	14	6	7.62 (0.300)	9.19 (0.362)	62
2008	16	7	8.89 (0.350)	10.46 (0.412)	54
2009	18	8	10.16 (0.400)	11.73 (0.462)	48
2010	20	9	11.43 (0.450)	13.00 (0.512)	43
2011	22	10	12.70 (0.500)	14.27 (0.562)	39
2012	24	11	13.97 (0.550)	15.54 (0.612)	36
2013	26	12	15.24 (0.600)	16.81 (0.662)	33
2014	28	13	16.51 (0.650)	18.08 (0.712)	31
2015	30	14	17.78 (0.700)	19.35 (0.762)	29
2016	32	15	19.05 (0.750)	20.62 (0.812)	27
2017	34	16	20.32 (0.800)	21.89 (0.862)	26
2018	36	17	21.59 (0.850)	23.16 (0.912)	24
2019	38	18	22.86 (0.900)	24.43 (0.962)	23
2020	40	19	24.13 (0.950)	25.70 (1.012)	22
2021	42	20	25.40 (1.000)	26.97 (1.062)	21
2022	44	21	26.67 (1.050)	28.24 (1.112)	20
2023	46	22	27.94 (1.100)	29.51 (1.162)	19
↓ ↓ 2024 ↓ ↓	48	23	29.21 (1.150)	30.78 (1.212)	18
24 5016 2025 10 001	50	24	30.48 (1.200)	32.05 (1.262)	17
24 5016 2026 10 001	52	25	31.75 (1.250)	33.32 (1.312)	17
↑ ↑ 2027 ↑ ↑	54	26	33.02 (1.300)	34.59 (1.362)	16
2028	56	27	34.29 (1.350)	35.86 (1.412)	15
2029	58	28	35.56 (1.400)	37.13 (1.462)	15
2030	60	29	36.83 (1.450)	38.40 (1.512)	14
2031	62	30	38.10 (1.500)	39.67 (1.562)	14
2032	64	31	39.37 (1.550)	40.94 (1.612)	13
2033	66	32	40.64 (1.600)	42.21 (1.662)	13
2034	68	33	41.91 (1.650)	43.48 (1.712)	13
2035	70	34	43.18 (1.700)	44.75 (1.762)	12
2036	72	35	44.45 (1.750)	46.02 (1.812)	12
2037	74	36	45.72 (1.800)	47.29 (1.862)	12
2038	76	37	46.99 (1.850)	48.56 (1.912)	11
2039	78	38	48.26 (1.900)	49.83 (1.962)	11
2040	80	39	49.53 (1.950)	51.10 (2.012)	11
2041	82	40	50.80 (2.000)	52.37 (2.062)	10
2042	84	41	52.07 (2.050)	53.64 (2.112)	10
2043	86	42	53.34 (2.100)	54.91 (2.162)	10
2044	88	43	54.61 (2.150)	56.18 (2.212)	10
2045	90	44	55.88 (2.200)	57.45 (2.262)	9
2046	92	45	57.15 (2.250)	58.72 (2.312)	9
2047	94	46	58.42 (2.300)	59.99 (2.362)	9
2048	96	47	59.69 (2.350)	61.26 (2.412)	9
2049	98	48	60.96 (2.400)	62.53 (2.462)	9
↓ ↓ 2050 ↓ ↓	100	49	62.23 (2.450)	63.80 (2.512)	8
24 5016 2051 10 001	102	50	63.50 (2.500)	65.07 (2.562)	8

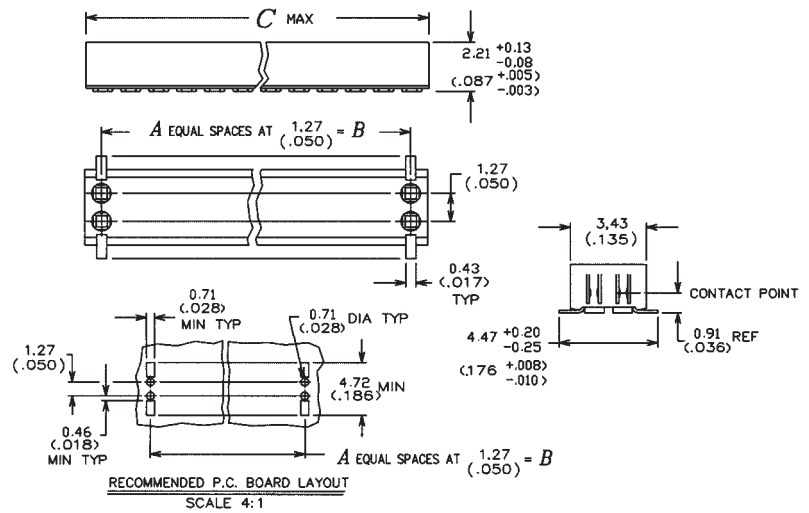

### Specifications

- Insulator Material – High temperature thermoplastic (UL 94 V-O)
- Contact Material – copper alloy
- Contact Plating – .000030-.000080 (0.00076-0.00203) nickel underplate all over  
.000015 (0.00038) min. gold in mating area  
.000075-.000150 (0.00191-0.00381) tin/lead on tails

### Mating Half

Part Number	Board/Board Stacking Height	See Page
24-5016-2XXX-10-001	1.52	9
12-5016-2XXX-10-001		12

### ORDERING CODE

24 5016 2XXX 10 0X1  
 PART NO. \_\_\_\_\_  
 SERIES \_\_\_\_\_  
 NUMBER X2 = NO. OF WAYS \_\_\_\_\_  
 0 = Standard Tube Packaging  
 8 = Tape and Reel

# Torson 0.050" 1.27mm



## 10-5016-2XXX-10-001 – Header

Part Number			No. of Positions	A	B	C Max.	Qty. Per Tube
10 5016	2004	10 001	4	1	1.27 (0.050)	2.54 (0.100)	224
↑	↑	2006	↑	↑	2.54 (0.100)	3.81 (0.150)	149
		2008	8	3	3.81 (0.150)	5.08 (0.200)	112
		2010	10	4	5.08 (0.200)	6.35 (0.250)	89
		2012	12	5	6.35 (0.250)	7.62 (0.300)	74
		2014	14	6	7.62 (0.300)	8.89 (0.350)	64
		2016	16	7	8.89 (0.350)	10.16 (0.400)	56
		2018	18	8	10.16 (0.400)	11.43 (0.450)	49
		2020	20	9	11.43 (0.450)	12.70 (0.500)	44
		2022	22	10	12.70 (0.500)	13.97 (0.550)	40
		2024	24	11	13.97 (0.550)	15.24 (0.600)	37
		2026	26	12	15.24 (0.600)	16.51 (0.650)	34
		2028	28	13	16.51 (0.650)	17.78 (0.700)	32
		2030	30	14	17.78 (0.700)	19.05 (0.750)	29
		2032	32	15	19.05 (0.750)	20.32 (0.800)	28
		2034	34	16	20.32 (0.800)	21.59 (0.850)	26
		2036	36	17	21.59 (0.850)	22.86 (0.900)	24
		2038	38	18	22.86 (0.900)	24.13 (0.950)	23
		2040	40	19	24.13 (0.950)	25.40 (1.000)	22
		2042	42	20	25.40 (1.000)	26.67 (1.050)	21
		2044	44	21	26.67 (1.050)	27.94 (1.100)	20
		2046	46	22	27.94 (1.100)	29.21 (1.150)	19
↓	↓	2048	↓	↓	29.21 (1.150)	30.48 (1.200)	18
10 5016	2050	10 001	50	24	30.48 (1.200)	31.75 (1.250)	17
10 5016	2052	10 001	52	25	31.75 (1.250)	33.02 (1.300)	17
↑	↑	2054	↑	↑	33.02 (1.300)	34.29 (1.350)	16
		2056	56	27	34.29 (1.350)	35.56 (1.400)	16
		2058	58	28	35.56 (1.400)	36.83 (1.450)	15
		2060	60	29	36.83 (1.450)	38.10 (1.500)	14
		2062	62	30	38.10 (1.500)	39.37 (1.550)	14
		2064	64	31	39.37 (1.550)	40.64 (1.600)	14
		2066	66	32	40.64 (1.600)	41.91 (1.650)	13
		2068	68	33	41.91 (1.650)	43.18 (1.700)	13
		2070	70	34	43.18 (1.700)	44.45 (1.750)	12
		2072	72	35	44.45 (1.750)	45.72 (1.800)	12
		2074	74	36	45.72 (1.800)	46.99 (1.850)	12
		2076	76	37	46.99 (1.850)	48.26 (1.900)	11
		2078	78	38	48.26 (1.900)	49.53 (1.950)	11
		2080	80	39	49.53 (1.950)	50.80 (2.000)	11
		2082	82	40	50.80 (2.000)	52.07 (2.050)	10
		2084	84	41	52.07 (2.050)	53.34 (2.100)	10
		2086	86	42	53.34 (2.100)	54.61 (2.150)	10
		2088	88	43	54.61 (2.150)	55.88 (2.200)	10
		2090	90	44	55.88 (2.200)	57.15 (2.250)	9
		2092	92	45	57.15 (2.250)	58.42 (2.300)	9
		2094	94	46	58.42 (2.300)	59.69 (2.350)	9
		2096	96	47	59.69 (2.350)	60.96 (2.400)	9
↓	↓	2098	↓	↓	60.96 (2.400)	62.23 (2.450)	9
10 5016	2100	10 001	100	49	62.23 (2.450)	63.50 (2.500)	8

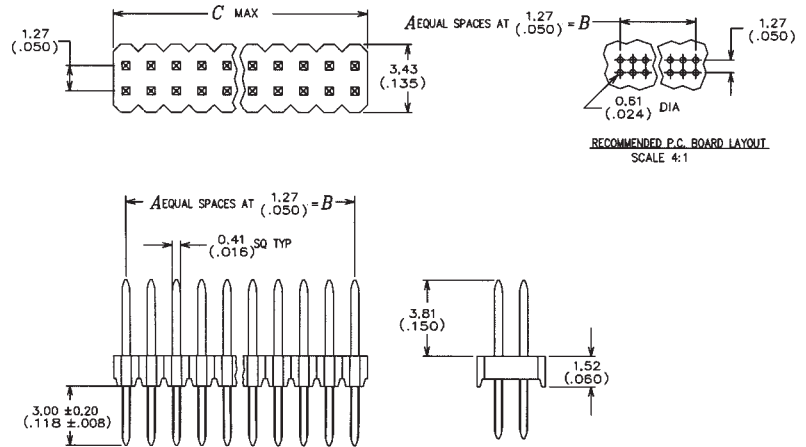

### Specifications

- Insulator Material – High temperature thermoplastic (UL 94 V-O)
- Contact Material – copper alloy
- Contact Plating – .000030–.000080 (0.00076–0.00203) nickel underplate all over  
.000015 (0.00038) min. gold in mating area  
.000075–.000150 (0.00191–0.00381) tin/lead on tails

### Mating Half

Part Number	Board/Board Stacking Height	See Page
10-5016-2XXX-10-001	6.09	10
20-5016-2XXX-10-001		5
10-5016-2XXX-10-001	6.09	10
21-5016-2XXX-10-001		6

### ORDERING CODE

PART NO. 10 5016 2XXX 10 0X1  
 SERIES \_\_\_\_\_  
 NO. OF WAYS \_\_\_\_\_

0 = Standard Tube Packaging  
 8 = Tape and Reel

# Torson 0.050" 1.27mm



## 11-5016-2XXX-10-001 – Header

Part Number			No. of Positions	A	B	C Max.	Qty. Per Tube
11 5016	2004	10 001	4	1	1.27 (0.050)	2.54 (0.100)	224
↑	↑	2006	↑	↑	2.54 (0.100)	3.81 (0.150)	149
		2008			3.81 (0.150)	5.08 (0.200)	112
		2010			5.08 (0.200)	6.35 (0.250)	89
		2012			6.35 (0.250)	7.62 (0.300)	74
		2014			7.62 (0.300)	8.89 (0.350)	64
		2016			8.89 (0.350)	10.16 (0.400)	56
		2018			10.16 (0.400)	11.43 (0.450)	49
		2020			11.43 (0.450)	12.70 (0.500)	44
		2022			12.70 (0.500)	13.97 (0.550)	40
		2024			13.97 (0.550)	15.24 (0.600)	37
		2026			15.24 (0.600)	16.51 (0.650)	34
		2028			16.51 (0.650)	17.78 (0.700)	32
		2030			17.78 (0.700)	19.05 (0.750)	29
		2032			19.05 (0.750)	20.32 (0.800)	28
		2034			20.32 (0.800)	21.59 (0.850)	26
		2036			21.59 (0.850)	22.89 (0.900)	24
		2038			22.89 (0.900)	24.13 (0.950)	23
		2040			24.13 (0.950)	25.40 (1.000)	22
		2042			25.40 (1.000)	26.67 (1.050)	21
		2044			26.67 (1.050)	27.94 (1.100)	20
		2046			27.94 (1.100)	29.21 (1.150)	19
↓	↓	2048	↓	↓	29.21 (1.150)	30.48 (1.200)	18
11 5016	2050	10 001	50	24	30.48 (1.200)	31.75 (1.250)	17
11 5016	2052	10 001	52	25	31.75 (1.250)	33.02 (1.300)	17
↑	↑	2054	↑	↑	33.02 (1.300)	34.29 (1.350)	16
		2056			34.29 (1.350)	35.56 (1.400)	16
		2058			35.56 (1.400)	36.83 (1.450)	15
		2060			36.83 (1.450)	38.10 (1.500)	14
		2062			38.10 (1.500)	39.37 (1.550)	14
		2064			39.37 (1.550)	40.64 (1.600)	14
		2066			40.64 (1.600)	41.91 (1.650)	13
		2068			41.91 (1.650)	43.18 (1.700)	13
		2070			43.18 (1.700)	44.45 (1.750)	12
		2072			44.45 (1.750)	45.72 (1.800)	12
		2074			45.72 (1.800)	46.99 (1.850)	12
		2076			46.99 (1.850)	48.26 (1.900)	11
		2078			48.26 (1.900)	49.53 (1.950)	11
		2080			49.53 (1.950)	50.80 (2.000)	11
		2082			50.80 (2.000)	52.07 (2.050)	10
		2084			52.07 (2.050)	53.34 (2.100)	10
		2086			53.34 (2.100)	54.61 (2.150)	10
		2088			54.61 (2.150)	55.88 (2.200)	10
		2090			55.88 (2.200)	57.15 (2.250)	9
		2092			57.15 (2.250)	58.42 (2.300)	9
		2094			58.42 (2.300)	59.69 (2.350)	9
		2096			59.69 (2.350)	60.96 (2.400)	9
↓	↓	2098	↓	↓	60.96 (2.400)	62.23 (2.450)	9
11 5016	2100	10 001	100	49	62.23 (2.450)	63.50 (2.500)	8

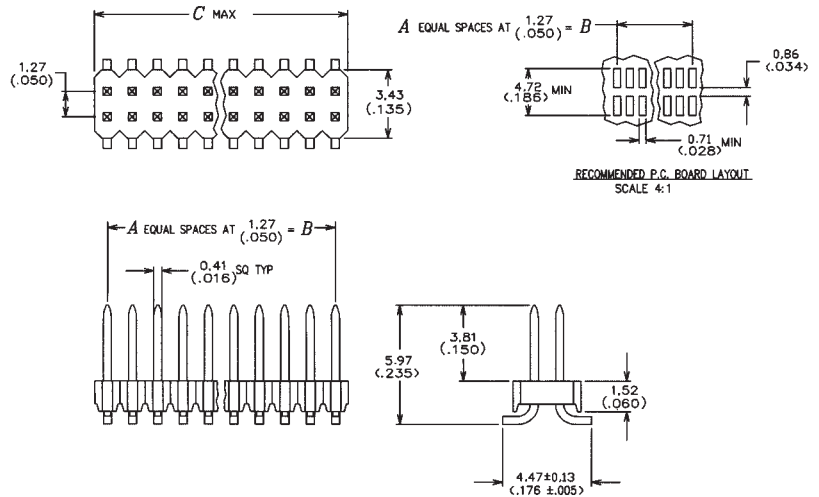

### Specifications

- Insulator Material – High temperature thermoplastic (UL 94 V-O)
- Contact Material – copper alloy
- Contact Plating – .000030–.000080 (0.00076–0.00203) nickel underplate all over  
.000015 (0.00038) min. gold in mating area  
.000075–.000150 (0.00191–0.00381) tin/lead on tails

### Mating Half

Part Number	Board/Board Stacking Height	See Page
11-5016-2XXX-10-001	6.73	11
20-5016-2XXX-10-001		5
11-5016-2XXX-10-001	6.73	11
21-5016-2XXX-10-001		6

### ORDERING CODE

PART NO. 11 5016 2XXX 10 0X1  
 SERIES \_\_\_\_\_  
 NO. OF WAYS \_\_\_\_\_

0 = Standard Tube Packaging  
 8 = Tape and Reel

# Torson 0.050" 1.27mm



## 12-5016-2XXX-10-001 – Header

Part Number			No. of Positions	A	B	C Max.	Qty. Per Tube
12 5016	2002	10 001	4	1	1.27 (0.050)	2.54 (0.100)	224
↑↑	2003	↑↑	6	2	2.54 (0.100)	3.81 (0.150)	149
	2004		8	3	3.81 (0.150)	5.08 (0.200)	112
	2005		10	4	5.08 (0.200)	6.35 (0.250)	89
	2006		12	5	6.35 (0.250)	7.62 (0.300)	74
	2007		14	6	7.62 (0.300)	8.89 (0.350)	64
	2008		16	7	8.89 (0.350)	10.16 (0.400)	56
	2009		18	8	10.16 (0.400)	11.43 (0.450)	49
	2010		20	9	11.43 (0.450)	12.70 (0.500)	44
	2011		22	10	12.70 (0.500)	13.97 (0.550)	40
	2012		24	11	13.97 (0.550)	15.24 (0.600)	37
	2013		26	12	15.24 (0.600)	16.51 (0.650)	34
	2014		28	13	16.51 (0.650)	17.78 (0.700)	32
	2015		30	14	17.78 (0.700)	19.05 (0.750)	29
	2016		32	15	19.05 (0.750)	20.32 (0.800)	28
	2017		34	16	20.32 (0.800)	21.59 (0.850)	26
	2018		36	17	21.59 (0.850)	22.86 (0.900)	24
	2019		38	18	22.86 (0.900)	24.13 (0.950)	23
	2020		40	19	24.13 (0.950)	25.40 (1.000)	22
	2021		42	20	25.40 (1.000)	26.67 (1.050)	21
	2022		44	21	26.67 (1.050)	27.94 (1.100)	20
	2023		46	22	27.94 (1.100)	29.21 (1.150)	19
↓↓	2024	↓↓	48	23	29.21 (1.150)	30.48 (1.200)	18
12 5016	2025	10 001	50	24	30.48 (1.200)	31.75 (1.250)	17
12 5016	2026	10 001	52	25	31.75 (1.250)	33.02 (1.300)	17
↑↑	2027	↑↑	54	26	33.02 (1.300)	34.29 (1.350)	16
	2028		56	27	34.29 (1.350)	35.56 (1.400)	16
	2029		58	28	35.56 (1.400)	36.83 (1.450)	15
	2030		60	29	36.83 (1.450)	38.10 (1.500)	14
	2031		62	30	38.10 (1.500)	39.37 (1.550)	14
	2032		64	31	39.37 (1.550)	40.64 (1.600)	14
	2033		66	32	40.64 (1.600)	41.91 (1.650)	13
	2034		68	33	41.91 (1.650)	43.18 (1.700)	13
	2035		70	34	43.18 (1.700)	44.45 (1.750)	12
	2036		72	35	44.45 (1.750)	45.72 (1.800)	12
	2037		74	36	45.72 (1.800)	46.99 (1.850)	12
	2038		76	37	46.99 (1.850)	48.26 (1.900)	11
	2039		78	38	48.26 (1.900)	49.53 (1.950)	11
	2040		80	39	49.53 (1.950)	50.80 (2.000)	11
	2041		82	40	50.80 (2.000)	52.07 (2.050)	10
	2042		84	41	52.07 (2.050)	53.34 (2.100)	10
	2043		86	42	53.34 (2.100)	54.61 (2.150)	10
	2044		88	43	54.61 (2.150)	55.88 (2.200)	10
	2045		90	44	55.88 (2.200)	57.15 (2.250)	9
	2046		92	45	57.15 (2.250)	58.42 (2.300)	9
	2047		94	46	58.42 (2.300)	59.69 (2.350)	9
	2048		96	47	59.69 (2.350)	60.96 (2.400)	9
↓↓	2049	↓↓	98	48	60.96 (2.400)	62.23 (2.450)	9
12 5016	2050	10 001	100	49	62.23 (2.450)	63.50 (2.500)	8

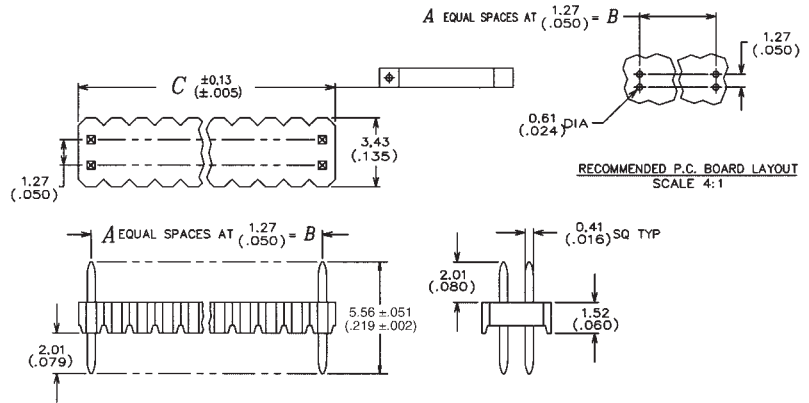

### Specifications

- Insulator Material – High temperature thermoplastic (UL 94 V-O)
- Contact Material – copper alloy
- Contact Plating – .000030–.000080 (0.00076–0.00203) nickel underplate all over  
.000015 (0.00038) min. gold in mating area  
.000075–.000150 (0.00191–0.00381) tin/lead on tails

### Mating Half

Part Number	Board/Board Stacking Height	See Page
12-5016-2XXX-10-001	1.52	12
24-5016-2XXX-10-001		9
12-5016-2XXX-10-001	3.73	12
22-5016-2XXX-10-001		7
12-5016-2XXX-10-001	3.73	12
23-5016-2XXX-10-001		8

### ORDERING CODE

PART NO. 12 5016 2XXX 10 0X1  
 SERIES \_\_\_\_\_  
 NUMBER X2 = NO. OF WAYS \_\_\_\_\_  
 0 = Standard Tube Packaging  
 8 = Tape and Reel

# Torson 0.050" 1.27mm



## 17-5016-2XXX-10-001 – Header

Part Number			No. of Positions	A	B	C Max.	Qty. Per Tube
17 5016	2002	10 001	4	1	1.27 (0.050)	2.54 (0.100)	224
↑	↑	2003	↑	↑	2.54 (0.100)	3.81 (0.150)	149
		2004	8	3	3.81 (0.150)	5.08 (0.200)	112
		2005	10	4	5.08 (0.200)	6.35 (0.250)	89
		2006	12	5	6.35 (0.250)	7.62 (0.300)	74
		2007	14	6	7.62 (0.300)	8.89 (0.350)	64
		2008	16	7	8.89 (0.350)	10.16 (0.400)	56
		2009	18	8	10.16 (0.400)	11.43 (0.450)	49
		2010	20	9	11.43 (0.450)	12.70 (0.500)	44
		2011	22	10	12.70 (0.500)	13.97 (0.550)	40
		2012	24	11	13.97 (0.550)	15.24 (0.600)	37
		2013	26	12	15.24 (0.600)	16.51 (0.650)	34
		2014	28	13	16.51 (0.650)	17.78 (0.700)	32
		2015	30	14	17.78 (0.700)	19.05 (0.750)	29
		2016	32	15	19.05 (0.750)	20.32 (0.800)	28
		2017	34	16	20.32 (0.800)	21.59 (0.850)	26
		2018	36	17	21.59 (0.850)	22.86 (0.900)	24
		2019	38	18	22.86 (0.900)	24.13 (0.950)	23
		2020	40	19	24.13 (0.950)	25.40 (1.000)	22
		2021	42	20	25.40 (1.000)	26.67 (1.050)	21
		2022	44	21	26.67 (1.050)	27.94 (1.100)	20
		2023	46	22	27.94 (1.100)	29.21 (1.150)	19
↓	↓	2024	↓	↓	29.21 (1.150)	30.48 (1.200)	18
17 5016	2025	10 001	50	24	30.48 (1.200)	31.75 (1.250)	17
17 5016	2026	10 001	52	25	31.75 (1.250)	33.02 (1.300)	17
↑	↑	2027	↑	↑	33.02 (1.300)	34.29 (1.350)	16
		2028	56	27	34.29 (1.350)	35.56 (1.400)	16
		2029	58	28	35.56 (1.400)	36.83 (1.450)	15
		2030	60	29	36.83 (1.450)	38.10 (1.500)	14
		2031	62	30	38.10 (1.500)	39.37 (1.550)	14
		2032	64	31	39.37 (1.550)	40.64 (1.600)	14
		2033	66	32	40.64 (1.600)	41.91 (1.650)	13
		2034	68	33	41.91 (1.650)	43.18 (1.700)	13
		2035	70	34	43.18 (1.700)	44.45 (1.750)	12
		2036	72	35	44.45 (1.750)	45.72 (1.800)	12
		2037	74	36	45.72 (1.800)	46.99 (1.850)	12
		2038	76	37	46.99 (1.850)	48.26 (1.900)	11
		2039	78	38	48.26 (1.900)	49.53 (1.950)	11
		2040	80	39	49.53 (1.950)	50.80 (2.000)	11
		2041	82	40	50.80 (2.000)	52.07 (2.050)	10
		2042	84	41	52.07 (2.050)	53.34 (2.100)	10
		2043	86	42	53.34 (2.100)	54.61 (2.150)	10
		2044	88	43	54.61 (2.150)	55.88 (2.200)	10
		2045	90	44	55.88 (2.200)	57.15 (2.250)	9
		2046	92	45	57.15 (2.250)	58.42 (2.300)	9
		2047	94	46	58.42 (2.300)	59.69 (2.350)	9
		2048	96	47	59.69 (2.350)	60.96 (2.400)	9
↓	↓	2049	↓	↓	60.96 (2.400)	62.23 (2.450)	9
17 5016	2050	10 001	100	49	62.23 (2.450)	63.50 (2.500)	8

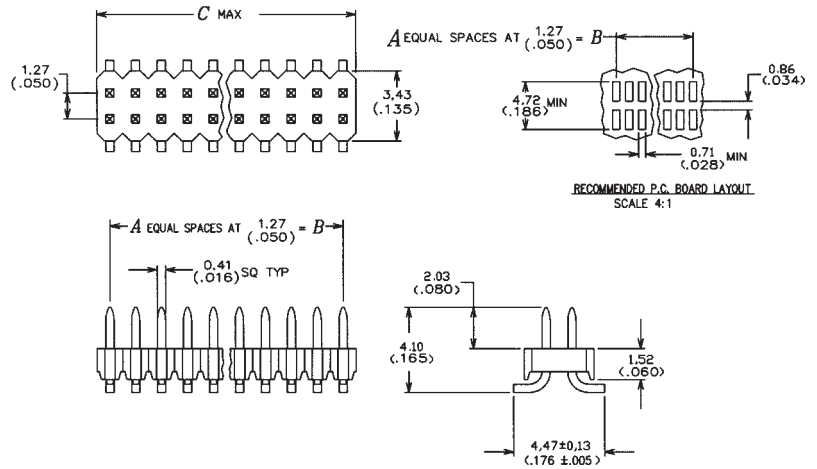

### Specifications

- Insulator Material – High temperature thermoplastic (UL 94 V-O)
- Contact Material – copper alloy
- Contact Plating – .000030–.000080 (0.00076–0.00203) nickel underplate all over  
.000015 (0.00038) min. gold in mating area  
.000075–.000150 (0.00191–0.00381) tin/lead on tails

### Mating Half

Part Number	Board/Board Stacking Height	See Page
17-5016-2XXX-10-001	4.28	13
23-5016-2XXX-10-001		8
17-5016-2XXX-10-001	4.28	13
22-5016-2XXX-10-001		7

### ORDERING CODE

PART NO. 17 5016 2XXX 10 0X1  
 SERIES \_\_\_\_\_  
 NUMBER X2 = NO. OF WAYS \_\_\_\_\_  
 0 = Standard Tube Packaging  
 8 = Tape and Reel

# Torson 0.050" 1.27mm



## 15-5016-2XXX-10-002 – Header

Part Number			No. of Positions	A	B	C
15 5016	2002	10 002	4	1	1.27 (0.050)	2.54 (0.100)
↑	↑	2003	↑	↑	2.54 (0.100)	3.81 (0.150)
	2004		8	3	3.81 (0.150)	5.08 (0.200)
	2005		10	4	5.08 (0.200)	6.35 (0.250)
	2006		12	5	6.35 (0.250)	7.62 (0.300)
	2007		14	6	7.62 (0.300)	8.89 (0.350)
	2008		16	7	8.89 (0.350)	10.16 (0.400)
	2009		18	8	10.16 (0.400)	11.43 (0.450)
	2010		20	9	11.43 (0.450)	12.70 (0.500)
	2011		22	10	12.70 (0.500)	13.97 (0.550)
	2012		24	11	13.97 (0.550)	15.24 (0.600)
	2013		26	12	15.24 (0.600)	16.51 (0.650)
↓	↓	2014	↓	↓	16.51 (0.650)	17.78 (0.700)
15 5016	2015	10 002	30	14	17.78 (0.700)	19.05 (0.750)
15 5016	2016	10 002	32	15	19.05 (0.750)	20.32 (0.800)
15 5016	2017	10 002	34	16	20.32 (0.800)	21.59 (0.850)
15 5016	2018	10 002	36	17	21.59 (0.850)	22.86 (0.900)

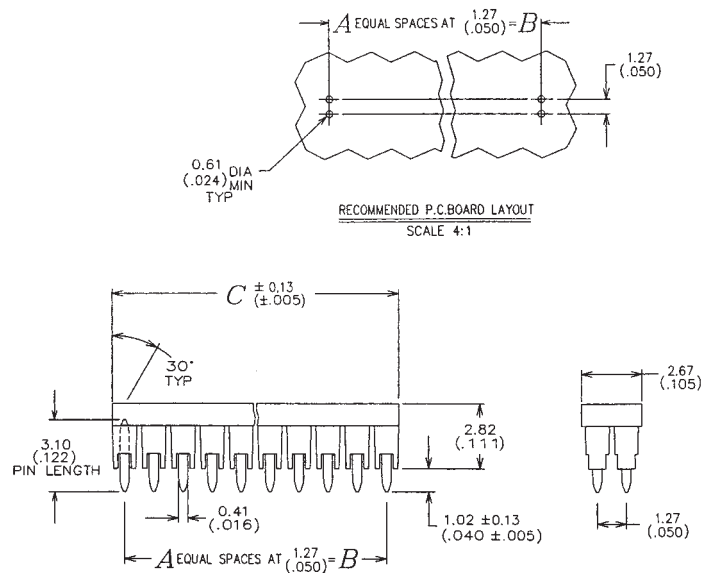

### Mating Half

Part Number	Board/Board Stacking Height	See Page
15-5016-2XXX-10-002	2.21	14
22-5016-2XXX-10-001		7
15-5016-2XXX-10-002	2.21	14
23-5016-2XXX-10-001		8

### ORDERING CODE

PART NO. 15 5016 2XXX 10 0X2

SERIES \_\_\_\_\_

NUMBER X2 = NO. OF WAYS \_\_\_\_\_

0 = Standard Tube Packaging  
8 = Tape and Reel

# Torson 0.050" 1.27mm



## Product Specifications

---

### Specifications

- Insertion Force – 4 oz. max.
- Withdrawal Force – 0.50 oz. min.
- Contact Resistance – 20 milliohms initial
- Dielectric Withstanding Voltage – 1000 Vac
- Current Rating – 1 amp max.
- Durability - 50 cycles
- Operating Temperature – -55°C to +105°C
- Insulation Resistance – 1000 megohms min.

### Solder Temperature Reflow Profile

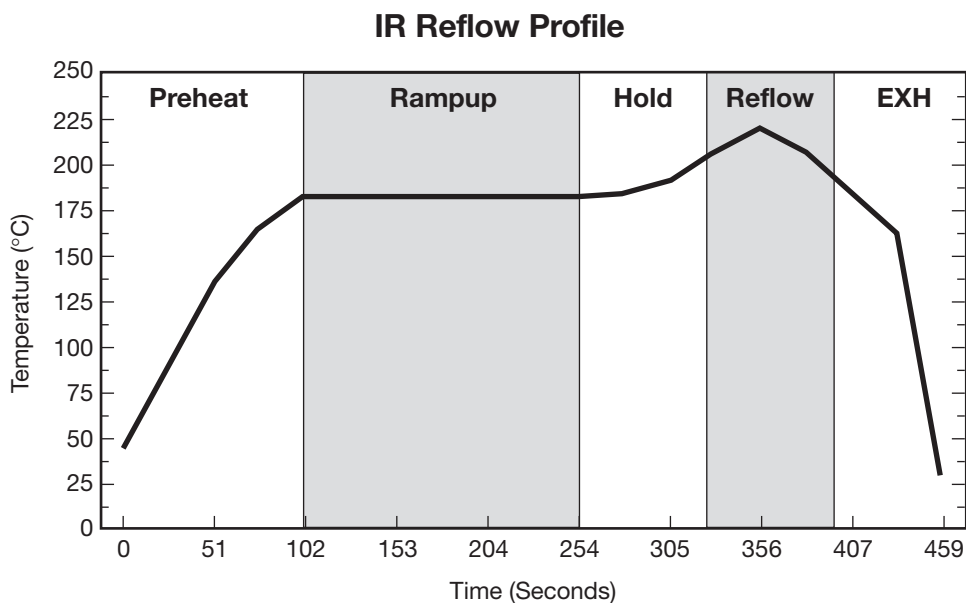



## AVX Products

### PASSIVES

#### Capacitors

- Multilayer Ceramic
- Tantalum
- Microwave
- Glass
- Film
- Power Film
- High Voltage Ceramic
- Ceramic Disc
- Trimmers
- SMPS

#### Resistors

- Chips
- Networks/Arrays
- Potentiometers

#### Timing Devices

- Resonators
- Oscillators
- Crystal

#### Filters

- EMI
- Bulk
- Saw
- Dielectric

#### Thin Film

- Inductors
- Fuses
- Capacitors

#### Integrated Passive

##### Components

- Low Inductance Chip Arrays
- “Z” Chips
- R/C Arrays
- Capacitor Arrays
- Dual Resonance Chips

#### Voltage Suppressor, Varistors and Thermistors

#### Acoustical Piezos

#### Ferrites

### CONNECTORS

- 2mm Hard Metric for CompactPCI®
- Automotive Connectors
- Board to Board Connectors –  
SMT and Through-Hole
- Card Edge
- Compact Flash
- Custom Designed Connectors
- Customized Backpanel, Racking and  
Harnessing Services
- DIN 41612 Connectors
- FFC/FPC Connectors
- Insulation Displacement Connectors
- I/O Connectors
- Memory Card Headers and Sockets
- Multi Media Card Connectors
- MOBO™, I/O, Board to Board and  
Battery Connectors
- PCMCIA
- Press-Fit Connectors
- Torsion, 1.27mm (.050") Board to  
Board Connectors
- Varicon®
- Wire to Board, Crimp or IDC

NOTICE: Specifications are subject to change without notice. Contact your nearest AVX Sales Office for the latest specifications. All statements, information and data given herein are believed to be accurate and reliable, but are presented without guarantee, warranty, or responsibility of any kind, expressed or implied. Statements or suggestions concerning possible use of our products are made without representation or warranty that any such use is free of patent infringement and are not recommendations to infringe any patent. The user should not assume that all safety measures are indicated or that other measures may not be required. Specifications are typical and may not apply to all applications.

## USA

### AVX Myrtle Beach, SC Corporate Offices

Tel: 843-448-9411  
FAX: 843-626-5186

### AVX Northwest, WA

Tel: 360-669-8746  
FAX: 360-699-8751

### AVX North Central, IN

Tel: 317-848-7153  
FAX: 317-844-9314

### AVX Northeast, MA

Tel: 508-485-8114  
FAX: 508-485-8471

### AVX Mid-Pacific, CA

Tel: 408-436-5400  
FAX: 408-437-1500

### AVX Southwest, AZ

Tel: 602-539-1496  
FAX: 602-539-1501

### AVX South Central, TX

Tel: 972-669-1223  
FAX: 972-669-2090

### AVX Southeast, NC

Tel: 919-878-6357  
FAX: 919-878-6462

### AVX Canada

Tel: 905-564-8959  
FAX: 905-564-9728

## EUROPE

### AVX Limited, England European Headquarters

Tel: ++44 (0)1252 770000  
FAX: ++44 (0)1252 770001

### AVX S.A., France

Tel: ++33 (1) 69.18.46.00  
FAX: ++33 (1) 69.28.73.87

### AVX GmbH, Germany - AVX

Tel: ++49 (0) 8131 9004-0  
FAX: ++49 (0) 8131 9004-44

### AVX GmbH, Germany - Elco

Tel: ++49 (0) 2741 2990  
FAX: ++49 (0) 2741 299133

### AVX srl, Italy

Tel: ++390 (0)2 614571  
FAX: ++390 (0)2 614 2576

### AVX sro, Czech Republic

Tel: ++420 (0)467 558340  
FAX: ++420 (0)467 558345

## ASIA-PACIFIC

### AVX/Kyocera, Singapore Asia-Pacific Headquarters

Tel: (65) 258-2833  
FAX: (65) 350-4880

### AVX/Kyocera, Hong Kong

Tel: (852) 2-363-3303  
FAX: (852) 2-765-8185

### AVX/Kyocera, Korea

Tel: (82) 2-785-6504  
FAX: (82) 2-784-5411

### AVX/Kyocera, Taiwan

Tel: (886) 2-2696-4636  
FAX: (886) 2-2696-4237

### AVX/Kyocera, China

Tel: (86) 21-6249-0314-16  
FAX: (86) 21-6249-0313

### AVX/Kyocera, Malaysia

Tel: (60) 4-228-1190  
FAX: (60) 4-228-1196

### Elco, Japan

Tel: 045-943-2906/7  
FAX: 045-943-2910

### Kyocera, Japan - AVX

Tel: (81) 75-604-3426  
FAX: (81) 75-604-3425

### Kyocera, Japan - KDP

Tel: (81) 75-604-3424  
FAX: (81) 75-604-3425

Contact:



<http://www.avxcorp.com>

S-TORSON5M200-N