

## Thin Film, Rectangular, Resistor Chips

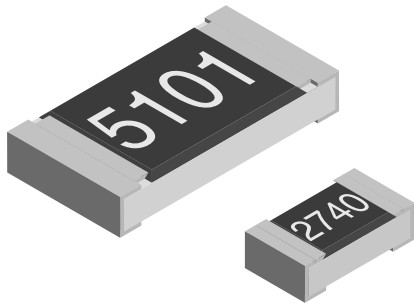

### FEATURES

- Metal film layer on high quality ceramic
- Protective top coat
- Solder contacts on Ni barrier layer  
(2010/2512 size = 100% Sn on Ni barrier)
- Excellent stability at different environmental conditions
- Low TC and tight tolerances

### STANDARD ELECTRICAL SPECIFICATIONS

MODEL	SIZE		POWER RATING P <sub>70°C</sub> (W)		LIMITING ELEMENT VOLTAGE  V ≅ MAX.	TEMPERATURE COEFFICIENT  ppm/°C	TOLERANCE  %	RESISTANCE RANGE  Ω	E-SERIES
	INCH	METRIC	CECC 40401-801	EIA 575					
TNPW0402	0402	1005	0.063	0.062	25	25 100 100	0.5 0.5 0.5	100R-10K 10R-91R 11K-100K	24-96 24 24-96
TNPW0603	0603	1608	0.1	0.062	75	25 25	0.1 0.5	100R-330K 10R-91R	24-96
TNPW0805	0805	2012	0.125	0.1	100	15 25, 50 25, 50	0.1 0.1, 0.5 0.5	100R-252K 49R9-252K 10R-49R8	24-192 24-192
TNPW1206	1206	3216	0.25	0.125	100	15 25, 50 50	0.1 0.1, 0.5 0.5	100R-1M 49R9-1M 22R1-49R8	24-192 24-192
TNPW1210	1210	3225	0.33*	0.25	100	25, 50 50	0.1, 0.5 0.5	49R9-1M 22R1-49R8	24-192
TNPW2010	2010	5025		0.4	150	50 25	0.5 0.1	22R1-49R8 49R9-362K	24-96 24-96
TNPW2512	2512	6332		0.5	200	50 25	0.5 0.1	22R1-49R8 49R9-700K	24-96 24-96

\*Size not specified in CECC

- Power rating depends on the max. Temperature at the solder point, the component placement density and the substrate material
- Extended values available on request.
- Looser tolerance or TC available
- Marking : 3 digits or 4 digits, 0402 no marking

### TECHNICAL SPECIFICATIONS

PARAMETER	UNIT	TNPW0402		TNPW0603		TNPW0805		TNPW1206		TNPW1210		TNPW2010		TNPW2512	
Rated Dissipation at 70°C (CECC 40401   EIA 575)	W	0.063	0.062	0.1	0.062	0.125	0.1	0.25	0.125	0.33	0.25		0.4		0.5
Limiting Element Voltage <sup>2)</sup>	V ≅	25		75		100		100		100		150		200	
Thermal Resistance <sup>1)</sup>	K/W	≤ 870 <sup>1)</sup>		≤ 550 <sup>1)</sup>		≤ 440 <sup>1)</sup>		≤ 220 <sup>1)</sup>		≤ 140 <sup>1)</sup>		≤ 90 <sup>1)</sup>		≤ 70 <sup>1)</sup>	
Insulation Resistance	Ω	> 10 <sup>9</sup>													
Category Temperature Range	°C	- 55 / + 125 (+ 155)													
Failure Rate	h <sup>-1</sup>	0.3 · 10 <sup>-9</sup>													
Weight / 1000pcs	g	0.65		2		5.5		10		16		28		39	

<sup>1)</sup>Measuring conditions in acc. with CECC 40401    <sup>2)</sup> Rated voltage:  $\sqrt{P \times R}$

### ORDERING INFORMATION

TNPW0805	1002	B	T9	RT1
MODEL	RESISTANCE VALUE	TOLERANCE	TC	PACKAGING
	Ω	B = ± 0.1%	T1 = ± 100 ppm/°C	RT1 Papertape 5000 pcs
	Ex: 1501 = 1.5k	C = 0.25%	T2 = ± 50 ppm/°C	
	10R0 = 10Ω	D = 0.5%	T9 = ± 25 ppm/°C	
	3303 = 330k	F = 1.0%	T10 = ± 15 ppm/°C	
			T13 = ± 10 ppm/°C	

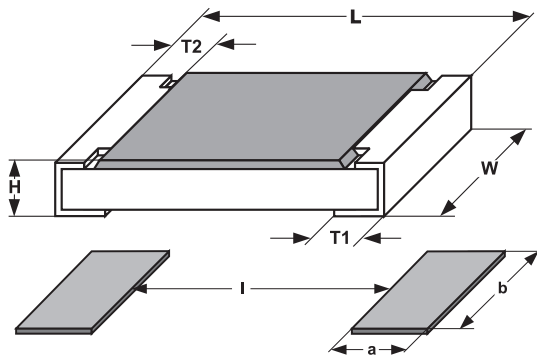
**DIMENSIONS**

SIZE		DIMENSIONS millimeters				
inch	metric	L	W	H	T1	T2
0402	1005	1.00 ± 0.05	0.50 ± 0.05	0.35 ± 0.05	0.2 ± 0.1	
0603	1608	1.6 ± 0.2	0.81 ± 0.2	0.4 ± 0.1	0.3 ± 0.2	
0805	2012	2.0 ± 0.2	1.24 ± 0.2	0.4 ± 0.1	0.4 ± 0.25	
1206	3216	3.2 ± 0.15	1.6 ± 0.15	0.61 ± 0.15	0.5 ± 0.25	
1210	3225	3.2 ± 0.15	2.49 ± 0.15	0.61 ± 0.15	0.46 ± 0.2	
2010		0.5 ± 0.5	2.5 ± 0.15	0.61 ± 0.05	0.6 ± 0.25	
2512		6.3 ± 0.20	3.1 ± 0.15	0.61 ± 0.05	0.6 ± 0.25	

SIZE		SOLDER PAD DIMENSIONS millimeters					
inch	metric	REFLOW SOLDERING			WAVE SOLDERING		
		a	b	l	a	b	l
0402	1005	0.4	0.6	0.5			
0603	1608	0.5	0.9	1.0	0.9	0.9	1.0
0805	2012	0.7	1.3	1.2	0.9	1.3	1.3
1206	3216	0.9	1.7	2.0	1.1	1.7	2.3
1210	3225	0.9	2.5	2.0	1.1	2.5	2.3
2010		1.0	2.5	3.9	1.2	2.5	3.9
2512		1.0	3.2	5.2	1.2	3.2	5.2

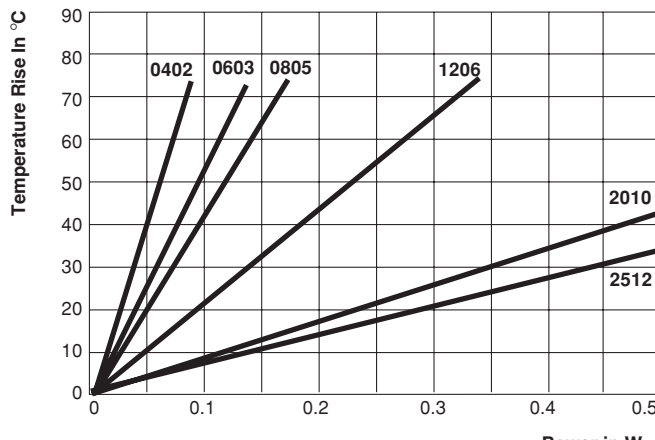

Temperature Rise

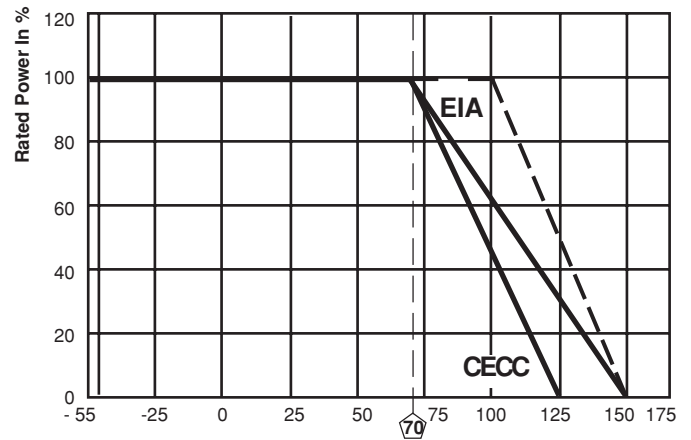

Derating

PACKAGING					
MODEL	REEL				
	TAPE WIDTH	DIAMETER	PIECES / REEL	PACKAGING CODE	
				PAPER <sup>2)</sup>	BLISTER
TNPW0402	8mm Papertape	180mm / 7"	10000	RT7	
TNPW0603	8mm Paper	180mm / 7"	5000	RT1	
		292mm / 11.5"	10000	RT5	
TNPW0805	8mm	180mm / 7"	1000	R52	R75
TNPW1206	Paper/Blisertape <sup>1)</sup>	180mm / 7"	5000	RT1	RG1
		292mm / 11.5"	10000	RT5	RT4
TNPW1210	8mm	180mm / 7"	5000	RT1	
	Paper	292mm / 11.5"	10000	RT5	
TNPW2010	12mm Blisertape	180mm/7"	4000		R02
TNPW2512	12mm Blisertape	180mm/7"	2000		R67
			4000		R82

<sup>1)</sup> only in combination with 180mm/7" and 330mm/13" plastic reel

<sup>2)</sup> plastic reel

• further information about packaging: see appropriate catalog or web page

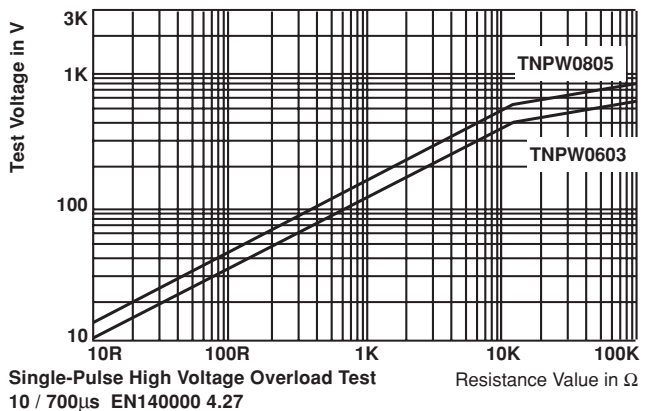
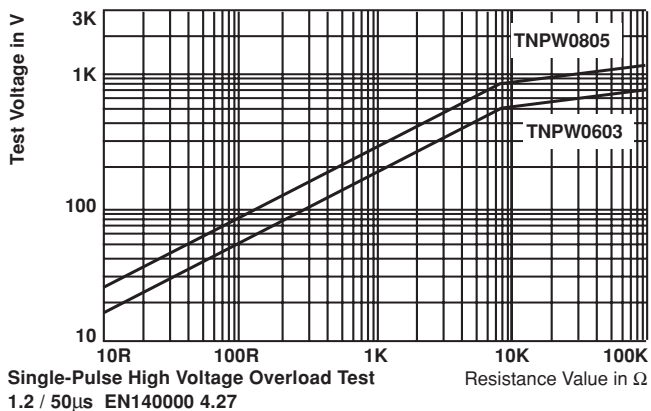
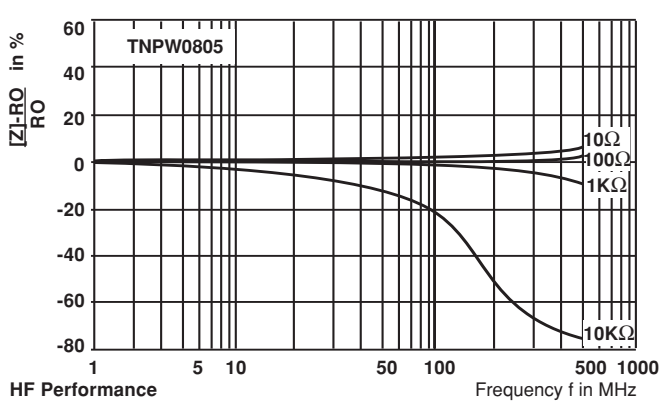
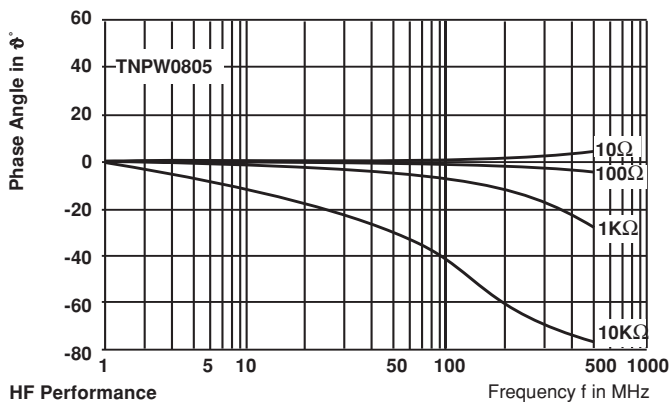
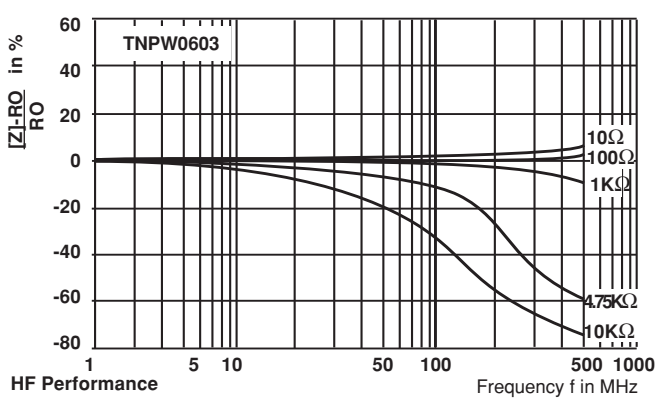
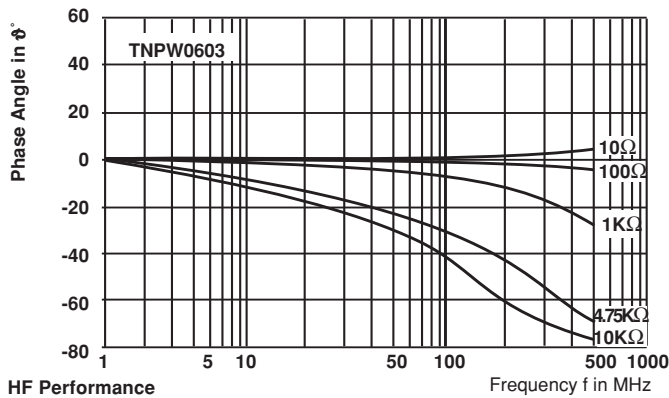
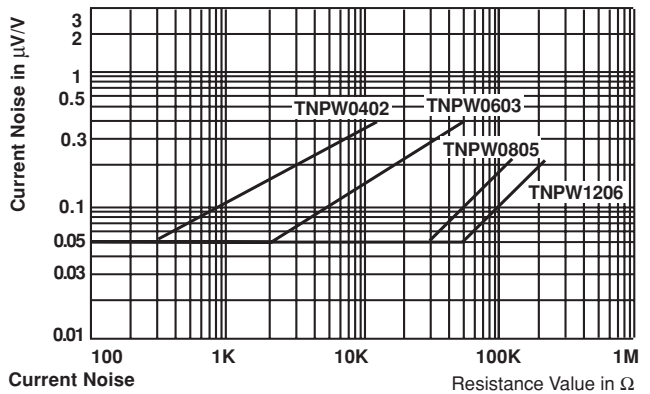
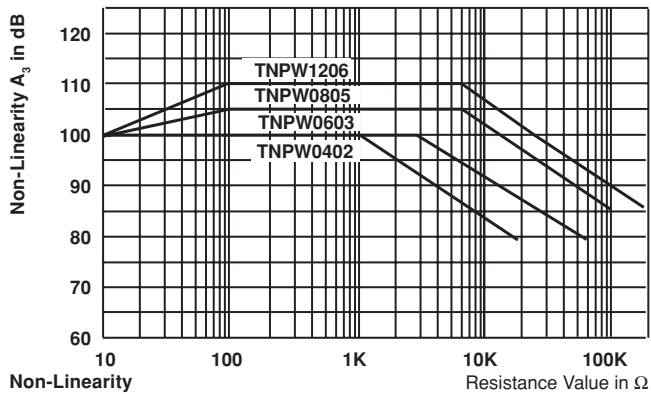

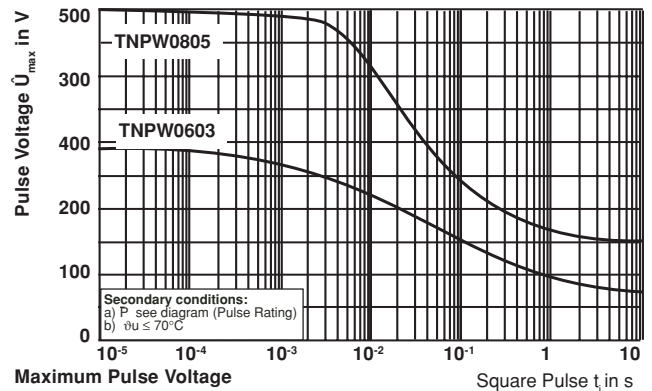
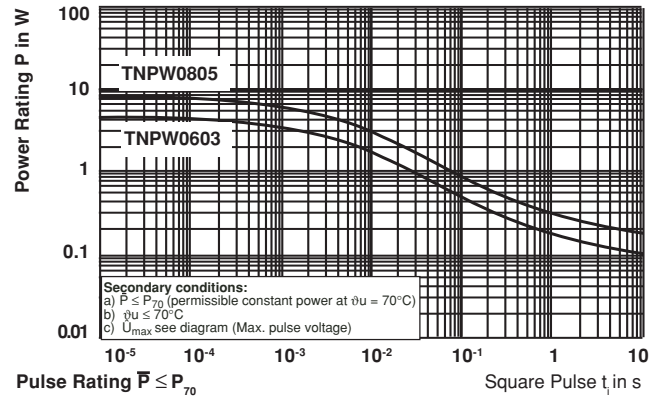
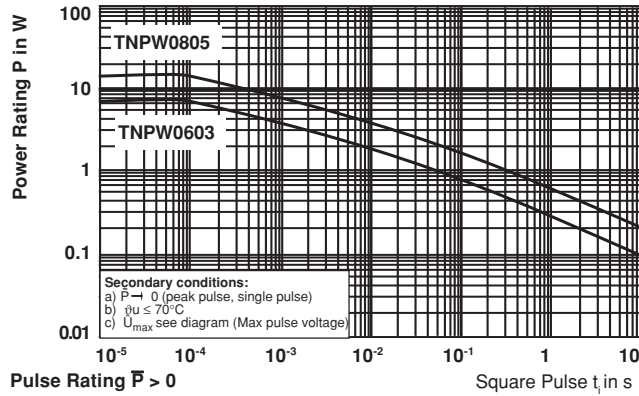

PERFORMANCE				
TEST	CONDITIONS OF TEST	TEST RESULTS		
		0402	0603 TO 2512	
		TOLERANCES%		
		0.5	0.1 / 0.25	0.5, 1.0%
		< 100R	≥ 100R	
Endurance Test at 70°C IEC 60115-1 4.25.1	1000 hours at 70°C, 1.5 hours "ON", 0.5 hours "OFF"	≤ ±3%	≤ ±0.1%	≤ ±0.05% ≤ ±0.25%
Endurance at UCT IEC 60115-1 4.25.3	1000 hours at 125 °C without load	≤ ±3%	≤ ±0.1%	≤ ±0.05% ≤ ±0.5%
Overload Test IEC 60115-1 4.13	Short time overload for 2 seconds 2.5 x rated voltage or ≤ 2 x limiting element voltage	≤ ±2%	≤ ±0.05%	≤ ±0.02% ≤ ±0.1%
Thermal Shock IEC 60115-1 4.19, IEC 60068-2-14	Rapid change between upper and lower category temperature	≤ ±1%	≤ ±0.05%	≤ ±0.02% ≤ ±0.1%
Damp Heat Steady State IEC 60115-1 4.24, IEC 60068-2-3	56 days at 40°C and 93% relative humidity	≤ ±3%	≤ ±0.1%	≤ ±0.05% ≤ ±0.5%
Resistance to Soldering Heat IEC 60115-1 4.18, IEC 60068-2-20	10 seconds at 260°C solder bath temperature	≤ ±2%	≤ ±0.05%	≤ ±0.02% ≤ ±0.1%

APPLICABLE SPECIFICATIONS
<ul style="list-style-type: none"> <li>• CECC40000 / 40400 / 40401-801</li> <li>• EN140400 / IEC 60115 – 1</li> <li>• EIA 575</li> </ul>