

SINGLE-IN-LINE SERIES 750

Solid ceramic machine insertable SIP networks.

CTS' solid ceramic construction effectively withstands thermal shock during soldering and extended thermal cycling. This is possible because CTS networks are constructed of a solid piece of ceramic, with a single thermal coefficient of expansion.

- Compact edge mount modules
- Ultra high stability and reliability
- Exclusive patented lead wire termination
- .100" lead spacing
- Alumina substrate
- Custom circuits available

Resistance Range:
Standard: 22Ω through 1 MegΩ
Special: below 22Ω and above 1 MegΩ

Resistance Tolerance:
Standard: ±2% or 0.5Ω
Special: ±0.25%, or 0.25Ω (whichever is greater)

Temperature Coefficient:
Standard: 100Ω to 1 MegΩ
±100 PPM/°C typical
10Ω to 99Ω
±200 PPM/°C typical
Tracking: Available to 50PPM/°C with same formulation and on same side of substrate.

Operating Temperature Range:
-55°C to +125°C

Dielectric Strength:
200VAC

Maximum Operating Voltage:
100V not to exceed rated power

Resistance Matching (2 like resistors):
50Ω to 100KΩ: 0.5% or 0.5Ω (whichever is greater)
100KΩ to 500KΩ: 1%
500KΩ to 3 MegΩ: 2%

Ratio Matching:
50Ω to 100Ω: ±1%
100Ω to 100KΩ: ±0.5%
100KΩ to 1 MegΩ: ±2%

Power Ratings:

B Dim—Standard .250 High				B Dim—Custom* .350 High			
# Pins	A Dim	Package Power		# Pins	A Dim	Package Power	
		@ 25°C	@ 70°C			@ 25°C	@ 70°C
4	9.60/ .378	1.0	0.9	4	9.60/ .378	1.3	0.9
5	12.14/ .478	1.2	0.8	5	12.14/ .478		
6	14.68/ .578	1.5	1.0	6	14.68/ .578	2.1	1.4
8	19.76/ .778	2.1	1.4	8	19.76/ .778	2.7	1.8
9	22.30/ .878	2.3	1.5	10	24.84/ .978	3.3	2.2
10	24.28/ .978	2.5	1.7	11	27.38/ 1.078	3.5	2.3
				12	29.45/ 1.178	3.7	2.5
	Schematic				Schematic		
Res. Power	1, 5, 7	.38	.25	Res. Power	1, 5, 7	.45	.3
Res. Power	3	.6	.4	Res. Power	3	.75	.5

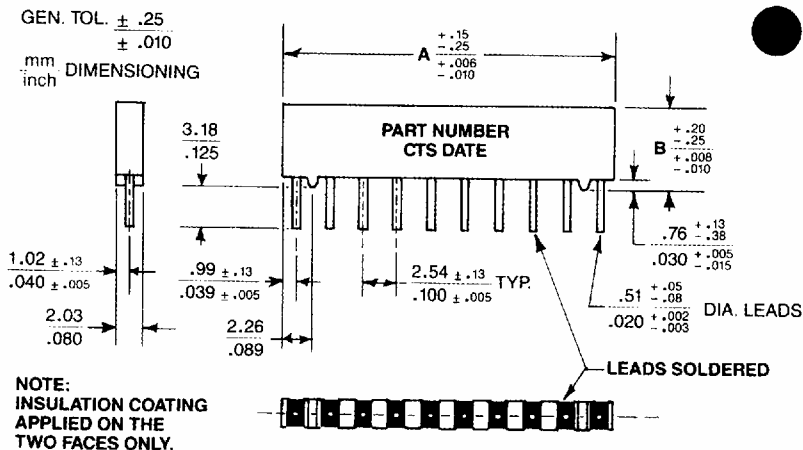

Standard Electrical Schematics, Resistor Values, Land Patterns, Power Derating, Packaging, Environmental Performance Specifications, and Custom Networks/Schematics are found on pages 14 to 19.

How to Order Series 750 Resistor Networks

Custom Networks

Custom networks are marked with either a customer part number or a non-descriptive CTS part number. Send documentation to CTS Sales Office giving schematic, resistor values and tolerance, and other non-standard information. See page 19 for custom network information.

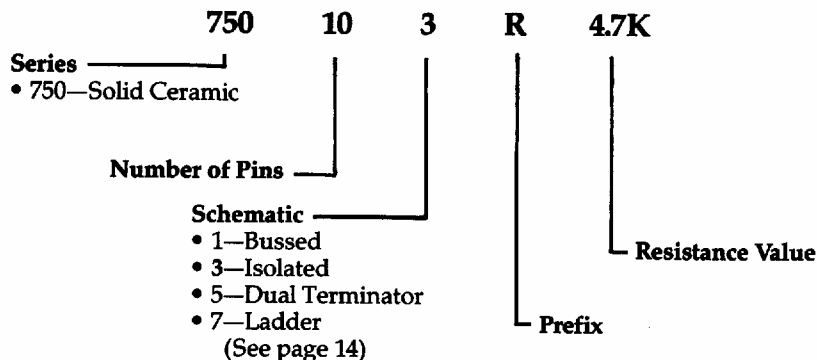

DUAL TERMINATOR RESISTOR VALUES

<u>R1/R2</u>	<u>Thevenin Equivalent</u>	<u>CTS Code</u>
22/50	15 ohm	150A
30/50	19 ohm	190A
30/620	29 ohm	290A
33/4.7K	33 ohm	330A
36/620	34 ohm	340A
43/620	40 ohm	400A
75/620	67 ohm	670A
100/200	67 ohm	670B
81/130	50 ohm	500A
100/150	60 ohm	600A
100/430	81 ohm	810A
106/169	65 ohm	650A
120/180	72 ohm	720A
160/240	96 ohm	960A
162/260	100 ohm	101B
180/220	100 ohm	101A
180/270	110 ohm	111A
180/300	110 ohm	111B
180/390	120 ohm	121A
220/270	120 ohm	121B
220/330	130 ohm	131A
250/250	130 ohm	131B
270/470	170 ohm	171A
330/330	170 ohm	171B
330/390	180 ohm	181A
330/470	190 ohm	191A
360/720	240 ohm	241B
390/620	240 ohm	241A
470/1K	320 ohm	321A
560/1K	360 ohm	361A
750/750	380 ohm	381A
750/2300	570 ohm	571A
1K/2K	670 ohm	671A
1.1K/2.2K	730 ohm	731A
1K/3.3K	770 ohm	771A
1.5K/1.5K	750 ohm	751A
1.5K/3.3K	1000 ohm	102A
2.2K/4.4K	1500 ohm	152A
2.2K/5.6K	1600 ohm	162A
3K/6.2K	2000 ohm	202A
3.3K/4.7K	1900 ohm	192A
3.9K/3.3K	1800 ohm	182A
5K/5K	2500 ohm	252A

1. All tolerances $\pm 2\%$. *
2. Other values available on request.
3. Suffix letter has no significance—assigned in sequential order.

*Series 752 has a standard tolerance of $\pm 5\%$.

STANDARD RESISTANCE VALUES

<u>(Ohms)</u>	<u>Code</u>	<u>(Ohms)</u>	<u>Code</u>
10	100	3900	392
12	120	4700	472
15	150	5600	562
18	180	6800	682
22	220	8200	822
27	270	10000	103
33	330	11000	113
39	390	12000	123
47	470	15000	153
56	560	18000	183
68	680	22000	223
82	820	27000	273
100	101	33000	333
120	121	39000	393
150	151	47000	473
180	181	56000	563
220	221	68000	683
270	271	82000	823
330	331	100000	104
390	391	110000	114
470	471	120000	124
560	561	150000	154
680	681	180000	184
820	821	220000	224
1000	102	270000	274
1100	112	330000	334
1200	122	390000	394
1500	152	470000	474
1800	182	560000	564
2200	222	680000	684
2700	272	820000	824
3300	332	1000000	105

Other values available upon request.

LADDER NETWORK VALUES.

<u>R</u>	<u>2R</u>	<u>CTS CODE</u>
10,000	20,000	103
25,000	50,000	253
50,000	100,000	503
100,000	200,000	104

RECOMMENDED SURFACE MOUNT LAND PATTERNS

Series 766, 767 and 768

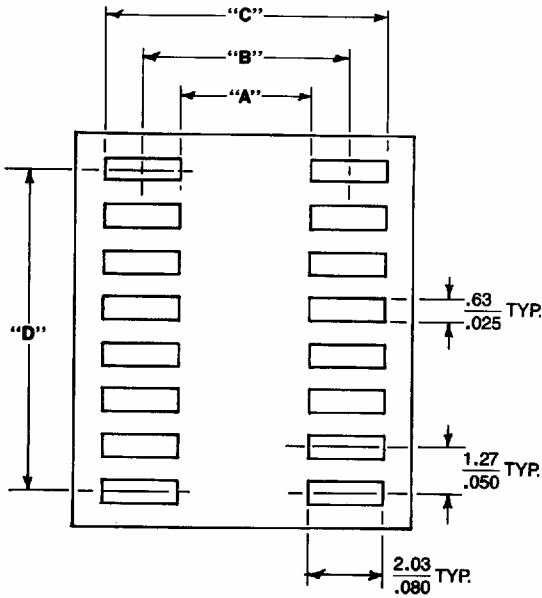

LEAD COUNT	A	B	C	D
766-8P	3.60	5.60	7.60	5.08
	.140	.220	.300	.200
766-14P	3.60	5.60	7.60	7.60
	.140	.220	.300	.300
766-16P	3.60	5.60	7.60	8.90
	.140	.220	.300	.350
767-14P or 768	5.34	7.37	9.40	7.60
	.210	.290	.370	.300
767-16P or 768	5.34	7.37	9.40	8.90
	.210	.290	.370	.350
768-20P	5.34	7.37	9.40	12.70
	.210	.290	.370	.500

Series 752

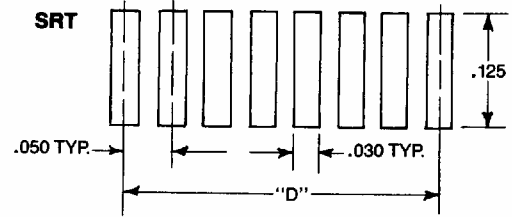

No. of Pins	D. Dim
8P	.350
9P	.400
10P	.450
12P	.550

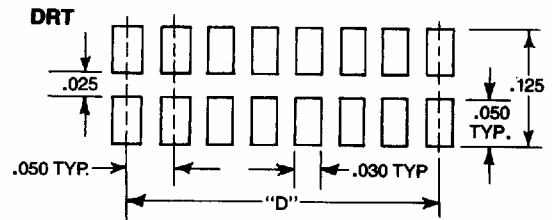

No. of Pins	D Dim.
16P	.350
18P	.400
20P	.450
24P	.550

POWER DERATING CURVE

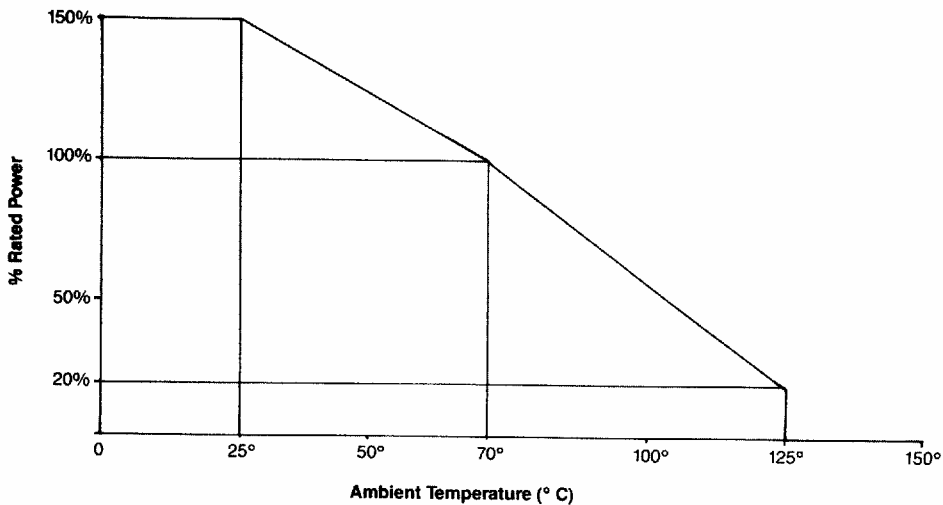

STANDARD PACKAGING

SERIES 766/767/768

Network Package	8 Pin 766	14 Pin 766	16 Pin 766	14 Pin 767/768	16 Pin 767/768	20 Pin 768
Tape & Reel						
Tape width	12mm	16mm	16mm	24mm	24mm	24mm
Tape pitch	8mm	8mm	8mm	12mm	12mm	12mm
Reel diameter	13"	13"	13"	13"	13"	13"
# parts/reel*	3,000	3,000	3,000	2,000	2,000	2,000
Reel diameter	7"	7"	7"			
# parts/reel*	800	800	800			
Slide Packs						
Tube length	20"	20"	20"	20"	20"	20"
# parts/slide pac*	99	56	49	48	43	35

*nominal full reels or slide packs

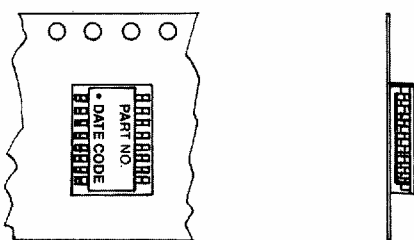

DIRECTION OF FEED

SERIES 752

Tape & Reel	All Parts
Tape width	24 mm
Tape pitch	4mm
Reel diameter	13"
Parts/reel	2500/5000
Bulk	All Parts
Antistatic Bag	500 pcs/Bag

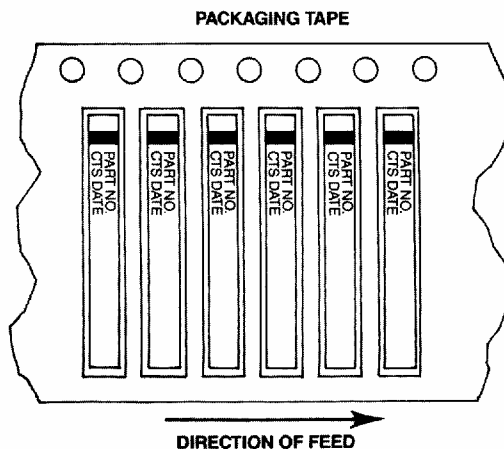

SERIES 750 & SERIES RC 750

Tube Pack	All Products 250 pcs/tube
-----------	-------------------------------------

Bar coding of reels and boxes available on request. CTS normally uses code configuration 39 in accordance with (AIM) USS 39 symbol specification. Outer container marking per EIA-556.

SERIES 760

Tube Pack	8 Pin 42 pcs/tube	14 Pin 25 pcs/tube	16 Pin 22 pcs/tube	18 Pin 20 pcs/tube
-----------	----------------------	-----------------------	-----------------------	-----------------------

SERIES 770

Bulk Pack	All Products 250 pcs/Bag									
Tube Pack (# of pins)	4	5	6	7	8	9	10	11	12	
Qty. per tube	50	40	32	28	25	22	19	18	16	

ENVIRONMENTAL PERFORMANCE SPECIFICATIONS

Test	Max. % Δ R	Mil. Std. 202 Method	Test Cond.	Test Description
Thermal Cycling Series 752, 766, 770	0.5%	107	B	5 cycles, -65° C to +125° C
Series 750, 760, 761, 767, 768,	0.25%			
Short Time Overload Series 752, 766, 770	0.5%			2½ x rated voltage, 5 sec. (100V max.)
Series 750, 760, 761, 767, 768,	0.25%			
Moisture Resistance Series 750, 752, 760, 761, 767, 768, 770	0.5%	106		240 hours, .1 rated load, -10° C to +65° C, 90% RH
Load Humidity Series 750, 752, 760, 761, 766, 767, 768, 770	1%			1000 hours, .1 rated load, 70° C, 85-92% RH
High Temp Exposure Series 752, 766, 767, 768, 770	1.0%			240 hours, no load, @125° C
Series 750, 760, 761	0.5%			
Load Life Series 752, 766, 767, 768	1.0%	108	F	2000 hours @ 70° C, rated load
Series 750, 760, 761, 770			D	1000 hours @ 70° C, rated load
Resistance to Solder Heat Series 752, 766, 767, 768	0.25%		B	10 sec. @ 260° C, dwell
Series 750, 760, 761, 770			A	350° C, 3 sec. dwell
Mechanical Shock Series 750, 752, 760, 761, 766, 767, 768, 770	0.25%	213	I	100g, 1 msec., 3 shocks each plane
Vibration Series 750, 752, 760, 761, 766, 767, 768, 770	0.25%	204	D	20g, 10-2000 Hz, 4 hours/plane
Terminal Strength Series 766, 767, 768	0.25%			0.9 Kg. pull, 30 sec., two 45° bends
Series 750				2.0 Kg. pull, 30 sec., two 45° bends
Series 760, 761, 770				2.0 Kg. pull, 30 sec., three 45° bends
Low Temp Storage Series 750, 752, 760, 761, 766, 767, 768, 770	0.25%			24 hours @ -65° C, no load
Low Temp Operation Series 752, 766, 767, 768 Series 750, 760, 761, 770	0.25%			45 min @ -65° C, full load