

CRYSTAL CONTROLLED OSCILLATORS

Surface Mount 5x7.5mm LVDS Clock Oscillator Series

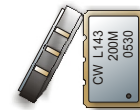

Lxxx - Series

ABSOLUTE MAXIMUM RATINGS

TABLE 1.0

PARAMETER	UNITS	MINIMUM	NOMINAL	MAXIMUM	UNITS	NOTE
Storage Temperature		-40	-	85	°C	
Supply Voltage	(Vcc)	-0.5	-	4.6	Vdc	
Input Voltage		-0.5	-	Vcc+0.5	Vdc	

OPERATING SPECIFICATIONS

TABLE 2.0

PARAMETER		MINIMUM	NOMINAL	MAXIMUM	UNITS	NOTE
Center Frequency	(Fo)	20	-	260	MHz	
Total Frequency Tolerance		(See Table 8 for full part number)				
Model Lx4x (See Table 8)		-20	-	20	ppm	1
Model Lx1x (See Table 8)		-25	-	25	ppm	1
Model Lx2x (See Table 8)		-50	-	50	ppm	1
Model Lx3x (See Table 8)		-100	-	100	ppm	1
Operating Temperature Range						
Model L1xx (See Table 8)		0	-	70	°C	
Model L3xx (See Table 8)		0	-	85	°C	
Model L2xx (See Table 8)		-40	-	85	°C	
Supply Voltage	(Vcc)					
Model Lxx2 (See Table 8)		2.375	2.500	2.625	Vdc	
Model Lxx3 (See Table 8)		3.135	3.3	3.465	Vdc	
Supply Current	(Icc)	-	60	90	mA	
Jitter (BW=10Hz to 20MHz)		-	3	5	pS RMS	
Jitter (BW=12kHz to 20MHz)		-	0.5	1	pS RMS	
SSB Phase Noise at 10Hz offset		-	-60	-	dBc/Hz	
SSB Phase Noise at 100Hz offset		-	-90	-	dBc/Hz	
SSB Phase Noise at 1KHz offset		-	-125	-	dBc/Hz	
SSB Phase Noise at 10KHz offset		-	-140	-	dBc/Hz	
SSB Phase Noise at 100KHz offset		-	-145	-	dBc/Hz	

INPUT CHARACTERISTICS

TABLE 3.0

PARAMETER		MINIMUM	NOMINAL	MAXIMUM	UNITS	NOTE
Disable Input Voltage (Low)	(Vil)	-	-	0.3Vcc	Vdc	2
Enable Input Voltage (High)	(Vih)	0.7Vcc	-	-	Vdc	2
Enable Time		-	-	500	us	
Disable Time		-	-	200	ns	
Standby Current (when part is Disabled)	(Icc)	-	-	30	uA	

LVDS OUTPUT CHARACTERISTICS

TABLE 4.0

PARAMETER		MINIMUM	NOMINAL	MAXIMUM	UNITS	NOTE
LOAD		-	-	100	Ohms	
Output Differential Voltage	(Vod)	250	-	450	mV	3
Duty Cycle measured at 50%		45	50	55	%	4
Rise / Fall Time measured 20% to 80%		-	0.7	1	ns	

PACKAGE CHARACTERISTICS

TABLE 5.0

Package	Hermetically sealed ceramic package and metal cover.
---------	--

Notes

- 1) Includes initial tolerance, deviation over temperature, supply and load variations, shock, vibration and 20 years aging.
- 2) When the oscillator is disabled, the outputs are at High Impedance. Output is enabled with no connection on pad 1.
- 3) Vod measured with 100 ohm resistor between the true output and the complementary output.
- 4) Duty Cycle measured at 50% of output swing.

DESCRIPTION

The Connor Winfield Lxxx - Series is a 5x7mm Surface Mount, LVDS, Fixed Frequency Crystal Controlled Oscillator (XO) designed for applications requiring tight frequency stability, wide temperature range and low jitter. Operating at 2.5V or 3.3V supply voltage, the Lxxx - Series provides LVDS Differential Outputs with enable / disable function. The surface mount package is designed for high-density mounting and is optimum for mass production.

FEATURES

2.5V or 3.3V Operation

LVDS Differential Outputs

Available Frequency Tolerances:

±20ppm

±25ppm

±50ppm

±100ppm

Available Temperature Ranges:

0 to 70 °C

0 to 85 °C

-40 to 85 °C

Enable / Disable Function

Low Standby Current

Low Jitter <1pS RMS

Surface Mount Package

Tape and Reel Packaging

RoHS Compliant / Lead Free

ORDERING INFORMATION

L143 - 200MHz

CLOCK
SERIES

CENTER
FREQUENCY

Specifications subject to change without notice.

CRYSTAL CONTROLLED OSCILLATORS

Package Layout and Dimensions

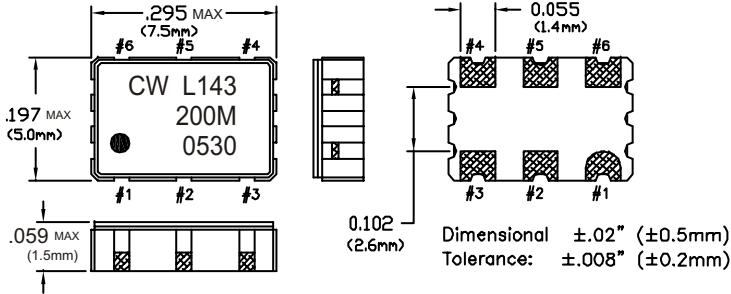

Pin Connections

TABLE 6.0

Pin	Connection
1	Enable / Disable
2	N/C
3	Ground
4	Q Output
5	Q Output
6	Vcc

Suggested Pad Layout

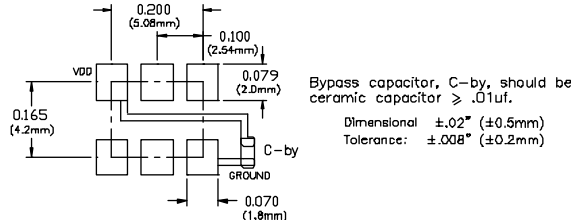

Enable / Disable Function

TABLE 7.0

Enable / Disable Function (Pad 1)	Output
High or Open	Enable
Low	Disable (High Impedance)

Model Number Table

TABLE 8.0

Frequency Tolerance ±20ppm	Frequency Tolerance ±25ppm	Frequency Tolerance ±50ppm	Frequency Tolerance ±100ppm	Supply Voltage	Temperature Range
L142	L112	L122	L132	2.5Vdc	0 to 70°C
L342	L312	L322	L332	2.5Vdc	0 to 85°C
L242	L212	L222	L232	2.5Vdc	-40 to 85°C
L143	L113	L123	L133	3.3Vdc	0 to 70°C
L343	L313	L323	L333	3.3Vdc	0 to 85°C
L243	L213	L223	L233	3.3Vdc	-40 to 85°C

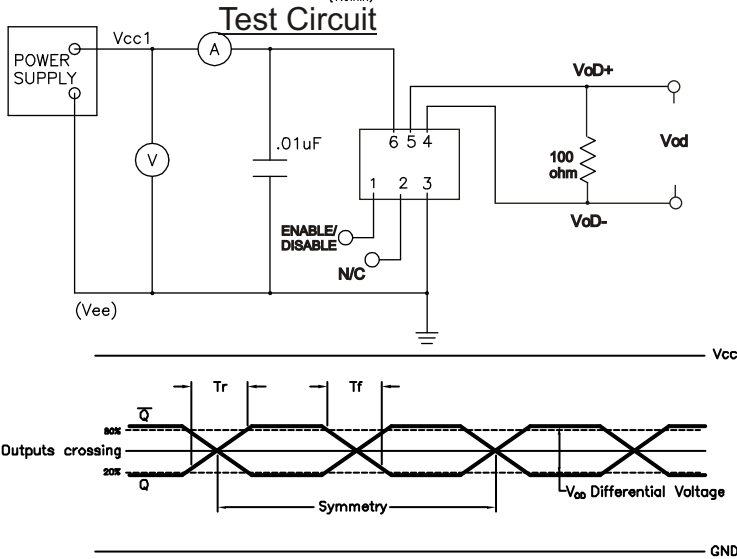

Ordering Information

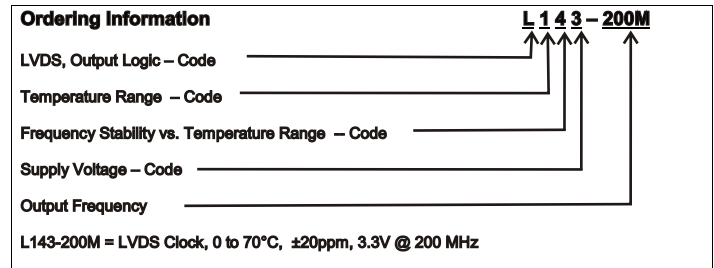

Tape and Reel Dimensions

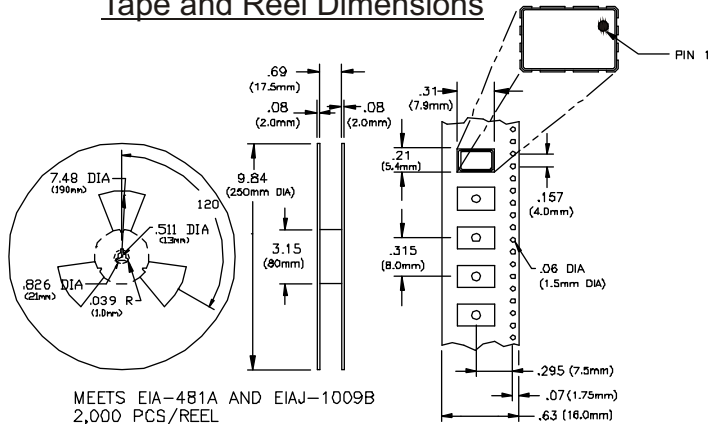

Soldering Profile

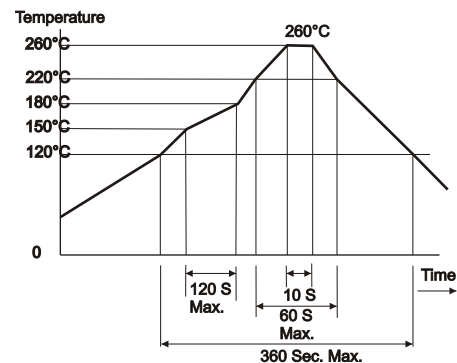

Specifications subject to change without notice.