

Features

- Lead free as standard*
- ESD protection 30 kV max.
- Surge protection >24 A
- Protects 1 line
- Uni/bidirectional configuration

Applications

- Computer notebooks
- Cellular phones
- Personal Digital Assistants (PDAs)
- Digital cameras

CDSOD323-TxxSC - TVS Diode Series

General Information

The markets of portable communications, computing and video equipment are challenging the semiconductor industry to develop increasingly smaller electronic components.

Bourns offers Transient Voltage Suppressor Diodes for surge and ESD protection applications in SOD323 package size format. The Transient Voltage Suppressor series offers a choice of voltage types ranging from 3 V to 36 V in a unidirectional or bidirectional configuration.

Bourns® Chip Diodes conform to JEDEC standards, are easy to handle on standard pick and place equipment and their flat configuration minimizes roll away. The Bourns® device meets IEC 61000-4-2 (ESD), IEC 61000-4-4 (EFT) and IEC 61000-4-5 (Surge) requirements.

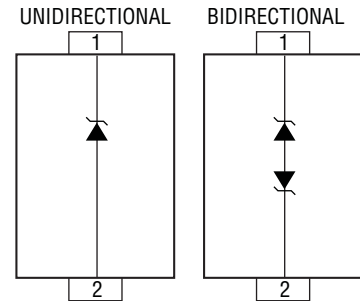

Electrical & Thermal Characteristics (@ T_A = 25 °C Unless Otherwise Noted)

Parameter	Symbol	Value	Unit
Unidirectional Peak Pulse Power (t _p = 8/20 μs)	P _{PP}	500	W
Bidirectional Peak Pulse Power (t _p = 8/20 μs)	P _{PP}	400	W
Operating Temperature	T _L	-55 to +150	°C
Storage Temperature	T _{STG}	-55 to +150	°C
ESD Protection (per IEC 61000-4-2) Contact - Min. Contact - Max. Air - Min. Air - Max.	ESD	±8 ±30 ±15 ±30	kV

Parameter	Symbol	CDSOD323-								Unit
		Uni-T03S	Bi-T03SC	Uni-T05S	Bi-T05SC	Uni-T08S	Bi-T08SC	Uni-T12S	Bi-T12SC	
Min. Breakdown Voltage @ 1 mA	V _{BR}	4.0	4.0	6.0	6.0	8.5	8.5	13.3	13.3	V
Working Peak Voltage	V _M	3.3	3.3	5.0	5.0	8.0	8.0	12.0	12.0	V
Maximum Clamping Voltage @ I _p = 1 A	V _F	7.0	8.0	9.8	9.8	13.4	13.4	19.0	19.0	V
Typical Clamping Voltage @ 8/20 μs @ I _{pp}	V _C	10.9 V @ 43 A	10.9 V @ 43 A	13.5 V @ 42 A	14.5 V @ 28 A	16.9 V @ 34 A	18.5 V @ 17 A	25.9 V @ 21 A	29.5 V @ 14 A	V
Maximum Leakage Current @ V _{WM}	I _D	125	125	10	10	10	10	1	1	μA
Typical Capacitance @ 0 V, 1 MHz	C _p	500	200	350	175	250	150	150	50	pF

Notes:

1. Part numbers with suffix "C" indicate bidirectional device, i.e. CDSOD323-T05SC.
2. For bidirectional devices only, the electrical specifications apply in both directions.

*No lead detected in standard tests of homogeneous materials.

**RoHS Directive 2002/95/EC Jan 27, 2003 including Annex.

Specifications are subject to change without notice.

Customers should verify actual device performance in their specific applications.

CDSOD323-TxxSC - TVS Diode Series

BOURNS®

Electrical & Thermal Characteristics (@ $T_A = 25^\circ\text{C}$ Unless Otherwise Noted)

Parameter	Symbol	CDSOD323-								Unit
		Uni-T15S	Bi-T15SC	Uni-T18S	Bi-T18SC	Uni-T24S	Bi-T24SC	Uni-T36S	Bi-T36SC	
Min. Breakdown Voltage @ 1 mA	V_{BR}	16.7	16.7	20.0	20.0	26.7	26.7	40.0	40.0	V
Working Peak Voltage	V_M	15.0	15.0	18.0	18.0	24.0	24.0	36.0	36.0	V
Maximum Clamping Voltage @ $I_P = 1\text{ A}$	V_F	24.0	24.0	29.0	29.0	43.0	43.0	60.0	60.0	V
Typical Clamping Voltage @ $8/20\ \mu\text{s}$ @ I_{PP}	V_C	30.0 V @ 17 A	33.0 V @ 12 A	40.0 V @ 9 A	40.0 V @ 9 A	49.0 V @ 12 A	46.2 V @ 9 A	75.0 V @ 5 A	75.0 V @ 5 A	V
Maximum Leakage Current @ V_{WM}	I_D	1								μA
Typical Capacitance @ 0 V, 1 MHz	C_P	100	40	90	40	88	40	75	35	pF

Notes:

- Part numbers with suffix "C" indicate bidirectional device, i.e. CDSOD323-T05SC.
- For bidirectional devices only, the electrical specifications apply in both directions.

Performance Graphs

Peak Pulse Power vs. Pulse Time

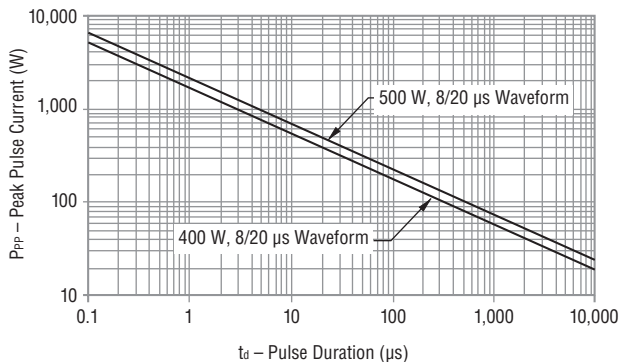

Pulse Waveform

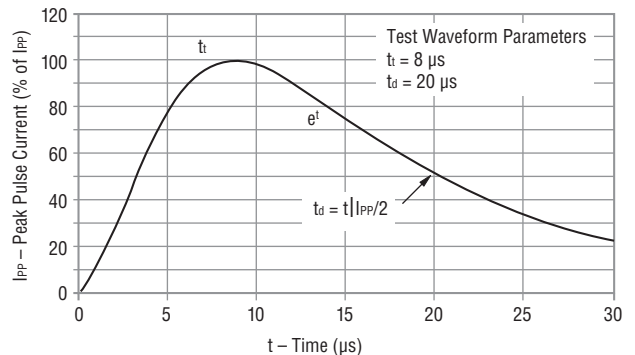

Block Diagram

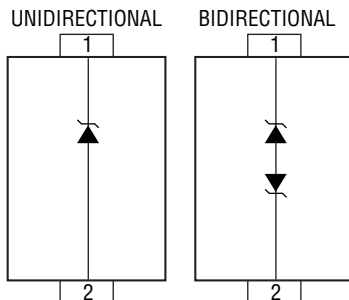

How to Order

CD SOD323 - T 05 SC

Common Code _____
 Chip Diode
 Package _____
 • SOD323 = SOD-323 Package
 Model _____
 T = Transient Voltage Suppressor
 Working Peak Reverse Voltage _____
 05 = 5 V_{RWM} (Volts)
 Suffix _____
 S = Standard Capacitance Unidirectional Diode
 SC = Standard Capacitance Bidirectional Diode

CDSOD323-TxxSC - TVS Diode Series



Product Dimensions

This is a molded JEDEC SOD-323 package with lead free 100 % Sn plating on the terminations. It weighs approximately 30 mg and has a flammability rating of UL 94V-0.

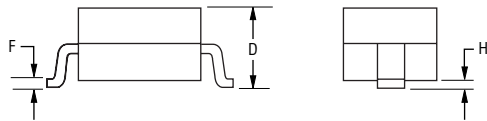
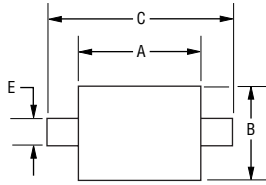

Dimensions	
A	$\frac{1.60 - 1.90}{(0.063 - 0.075)}$
B	$\frac{1.15 - 1.45}{(0.045 - 0.057)}$
C	$\frac{2.39 - 2.70}{(0.094 - 0.106)}$
D	$\frac{0.92 - 1.10}{(0.036 - 0.043)}$
E	$\frac{0.25 - 0.40}{(0.010 - 0.016)}$
F	$\frac{0.10 - 0.20}{(0.004 - 0.008)}$
H	$\frac{0.10}{(0.004)}$ MAX.

DIMENSIONS: $\frac{\text{MM}}{\text{(INCHES)}}$

Recommended Footprint

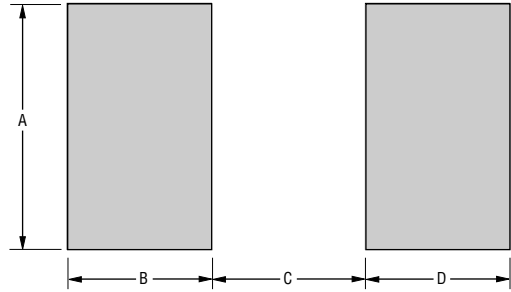

Dimensions (Nominal)	
A	$\frac{0.80}{(0.031)}$
B	$\frac{0.80}{(0.031)}$
C	$\frac{1.40}{(0.055)}$
D	$\frac{0.80}{(0.031)}$

DIMENSIONS: $\frac{\text{MM}}{\text{(INCHES)}}$

Typical Part Marking

Each device has device marking outlined below and the unidirectional devices have an additional Polarity Band indicating the cathode.

CDSOD323-T03S	A
CDSOD323-T03SC	G
CDSOD323-T05S	B
CDSOD323-T05SC	H
CDSOD323-T08S	C
CDSOD323-T08SC	J
CDSOD323-T12S	D
CDSOD323-T12SC	K
CDSOD323-T15S	E
CDSOD323-T15SC	L
CDSOD323-T18S	O
CDSOD323-T18SC	N
CDSOD323-T24S	F
CDSOD323-T24SC	M
CDSOD323-T36S	R
CDSOD323-T36SC	T

CDSOD323-TxxSC - TVS Diode Series

BOURNS®

Packaging Information

The surface mount product is packaged in an 8 mm x 4 mm tape and reel format per EIA-481 standard.

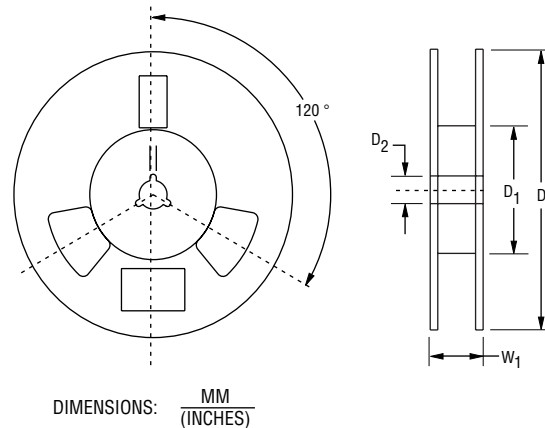
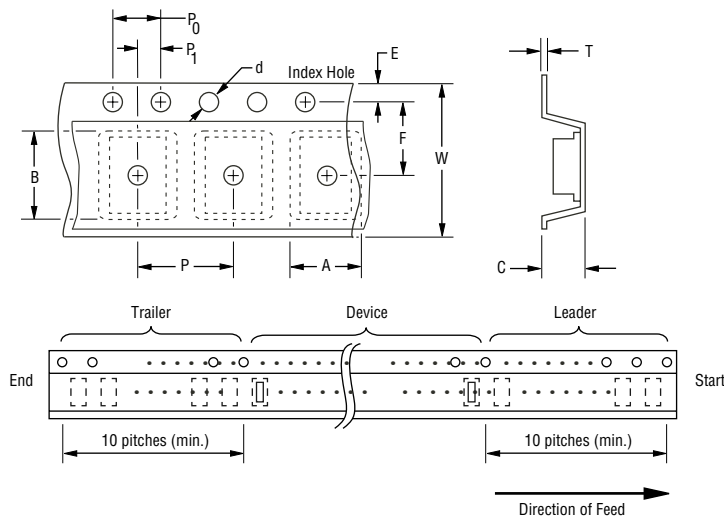

Devices are packed in accordance with EIA standard RS-481-A.

Item	Symbol	SOD-323
Carrier Width	A	$\frac{1.55 \pm 0.10}{(0.061 \pm 0.004)}$
Carrier Length	B	$\frac{2.90 \pm 0.10}{(0.114 \pm 0.004)}$
Carrier Depth	C	$\frac{1.35 \pm 0.10}{(0.053 \pm 0.004)}$
Sprocket Hole	d	$\frac{1.55 \pm 0.05}{(0.061 \pm 0.002)}$
Reel Outside Diameter	D	$\frac{178}{(7.008)}$
Reel Inner Diameter	D ₁	$\frac{80.0}{(3.150)}$ Min.
Feed Hole Diameter	D ₂	$\frac{13.0 \pm 0.20}{(0.512 \pm 0.008)}$
Sprocket Hole Position	E	$\frac{1.75 \pm 0.10}{(0.069 \pm 0.004)}$
Punch Hole Position	F	$\frac{3.50 \pm 0.05}{(0.138 \pm 0.002)}$
Punch Hole Pitch	P	$\frac{4.00 \pm 0.10}{(0.157 \pm 0.004)}$
Sprocket Hole Pitch	P ₀	$\frac{4.00 \pm 0.10}{(0.157 \pm 0.004)}$
Embossment Center	P ₁	$\frac{2.00 \pm 0.05}{(0.079 \pm 0.002)}$
Overall Tape Thickness	T	$\frac{0.20 \pm 0.10}{(0.008 \pm 0.004)}$
Tape Width	W	$\frac{8.00 \pm 0.20}{(0.315 \pm 0.008)}$
Reel Width	W ₁	$\frac{13.5}{(0.531)}$ Max.
Quantity per Reel	--	3,000

REV. 09/11

Specifications are subject to change without notice. Customers should verify actual device performance in their specific applications.