

# Data Accessories

Allen Tel Products, Inc. offers a variety of data accessories to compliment the growing data communications market.

- Adapter and Connector Kits
- Gender Changers
- Wall Plates
- RS 232 Mini-Tester
- Gender Adapter
- Computer, Monitor and Printer Cables

Our Data products are designed for ease of installation and to provide high, quality performance in supporting the layout of structured cabling systems.

Data Adapter Kit.....	Page 93	Gender Adapter.....	Page 95
Shielded Adapter Kit.....	Page 93	Data Stainless Steel Wall Plates.....	Page 95
Connector Kit.....	Page 93	RS232 Mini-Tester.....	Page 96
Shielded Connector Kit.....	Page 94	Null Modem.....	Page 96
Data Kit Insertion Tool.....	Page 94	RS232 Adapter Kit.....	Page 96
ATD Crimping Tool.....	Page 94	Monitor Cables.....	Page 98
Mini Gender Changers.....	Page 94	Printer Cables.....	Page 98
Standard Gender Changers.....	Page 95	General Use Cables.....	Page 98

# Data Accessories

## Data Adapter Kit

- Adapter allows connection between 9 and 15-pin equipped devices with DB-type connectors to standard telephone wiring utilizing modular jacks
- The 6-conductor RJ14 modular jack may be connected in the field to male or female pins which snap into the appropriate 9 or 15-pin DB connector body
- See Page 97 for wiring diagrams
- UL Listed and CSA Listed



Part Number	Part Description	Std. Pkg. Qty.	Std. Ctn. Qty.
ATDB9F-6	6-cond. jack to female 9-pin DB	1	50
ATDB9F-8	8-cond. jack to female 9-pin DB	1	50
ATDB9M-6	6-cond. jack to male 9-pin DB	1	50
ATDB9M-8	8-cond. jack to male 9-pin DB	1	50
ATDB15F-6	6-cond. jack to female 15-pin DB	1	50
ATDB15F-8	8-cond. jack to female 15-pin DB	1	50
ATDB15M-6	6-cond. jack to male 15-pin DB	1	50
ATDB15M-8	8-cond. jack to male 15-pin DB	1	50
ATDB9F-DEC	6-cond. DEC jack to female 9-pin DB	1	50
ATDB9M-DEC	6-cond. DEC jack to male 9-pin DB	1	50

## Shielded Adapter Kit

- Metalized plastic hood e/w thumb screws for easy installation
- 9 and 25-pin DB connectors with an integral RJ45 non-keyed 8-contact modular jack e/w pre-terminated male or female contacts
- See Page 97 for wiring diagrams

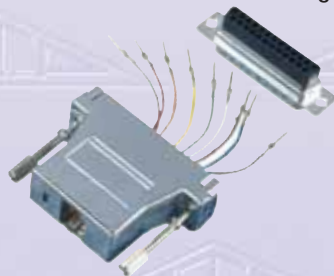

Part Number	Part Description	Std. Pkg. Qty.	Std. Ctn. Qty.
ATDB9FS-8	9-pin DB connector kit female	1	50
ATDB9MS-8	9-pin DB connector kit male	1	50
ATRA8FS	25-pin DB connector kit female e/w two 3.50" red straps	1	50
ATRA8MS	25-pin DB connector kit male e/w two 3.50" straps	1	50

## Connector Kit

- Type "D" male and female connectors with 9, 15 and 25-pin formats
- Gray plastic shell, crimp-type contacts, metal strain relief and assembly hardware

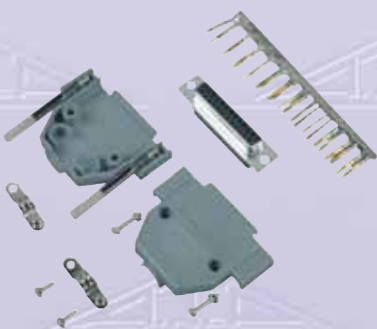

Part Number	Part Description	Std. Pkg. Qty.	Std. Ctn. Qty.
ATD9FCK	Connector kit 9-pos. female	1	50
ATD9MCK	Connector kit 9-pos. male	1	50
ATD15FCK	Connector kit 15-pos. female	1	50
ATD15MCK	Connector kit 15-pos. male	1	50
ATD25FCK	Connector kit 25-pos. female	1	50
ATD25MCK	Connector kit 25-pos. male	1	50

# Data Accessories

## Shielded Connector Kit

- Metalized plastic hood
- 9, 15 and 25-pin DB connectors with crimp-type male or female contacts, strain relief bracket and assembly hardware



Part Number	Part Description	Std. Pkg. Qty.	Std. Ctn. Qty.
ATD9FCKS	Shielded 9-pin DB connector kit female	1	50
ATD9MCKS	Shielded 9-pin DB connector kit male	1	50
ATD15FCKS	Shielded 15-pin DB connector kit female	1	50
ATD15MCKS	Shielded 15-pin DB connector kit male	1	50
ATD25FCKS	Shielded 25-pin DB connector kit female	1	50
ATD25MCKS	Shielded 25-pin DB connector kit male	1	50

## Data Kit Insertion Tool

- Insertion of contacts on "DB" and "D" connections



Part Number	Part Description	Std. Pkg. Qty.	Std. Ctn. Qty.
ATD100	Insertion Tool	5	100

## ATD Crimping Tool

- Carbon steel with black oxide finish
- Clamper
- Stripper
- Cutter
- Looping

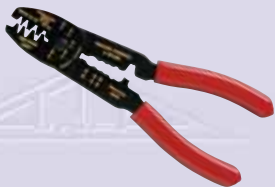

Part Number	Part Description	Std. Pkg. Qty.	Std. Ctn. Qty.
ATD200	ATD Crimping Tool	1	1

## Mini-Gender Changers

- Wired pin-to-pin
- Single contact shielded construction ensures minimal signal loss and provides full protection from electrical EMI and RFI interference
- Low profile shielded



Part Number	Part Description	Std. Pkg. Qty.	Std. Ctn. Qty.
ATGM9FF	DB9, 9-pin female-to-female connectors	1	50
ATGM9MM	DB9, 9-pin male-to-male plugs	1	50
ATGM15FF	DB15, 15-pin female-to-female connectors	1	50
ATGM15MM	DB15, 15-pin male-to-male plugs	1	50
ATGM25FF	DB25, 25-pin female-to-female connectors	1	50
ATGM25MM	DB25, 25-pin male-to-male plugs	1	50
ATGM37FF	DB37, 37-pin female-to-female connectors	1	50
ATGM37MM	DB37, 37-pin male-to-male plugs	1	50



# Data Accessories

## Standard Gender Changers

- Inexpensive way to avoid modifying or replacing incompatible RS232 or other computer cables
- Wired pin-to-pin
- Shielded



Part Number	Part Description	Std. Pkg. Qty.	Std. Ctn. Qty.
ATGC9FF	9-pin female-to-female	1	50
ATGC9MM	9-pin male-to-male	1	50
ATGC15FF	15-pin female-to-female	1	50
ATGC15MM	15-pin male-to-male	1	50
ATGC25FF	25-pin female-to-female	1	50
ATGC25MM	25-pin male-to-male	1	50

## Gender Adapter

- Converts a DB9 cable or connector to a DB25 cable or connector
- Shielded
- See Page 97 for wiring diagrams



Part Number	Part Description	Std. Pkg. Qty.	Std. Ctn. Qty.
ATGC9F25M	9-pin female to 25-pin male	1	50
ATGC9M25F	9-pin male to 25-pin female	1	50

## Data Stainless Steel Wall Plates



Part Number	Part Description	Std. Pkg. Qty.	Std. Ctn. Qty.
ATBK9	For one DB9 connector	1	50
ATBK9-2	For two DB9 connectors	1	50
ATBK15	For one DB15 connector	1	50
ATBK25	For one DB25 connector	1	50

# Data Accessories

## RS232 Mini-Tester



- Provides method of diagnosing RS232 interface problems
- Connects from the RS232 port to data line or modem
- LEDs indicate the status of pin 2 (transmit data, TD), pin 3 (receive data, RD), pin 4 (request to send, RTS), pin 5 (clear to send, CTS), pin 6 (data set ready, DSR), pin 8 (carrier detect, CD) and pin 20 (data terminal ready, DTR)

Part Number	Part Description	Std. Pkg. Qty.	Std. Ctn. Qty.
ATMT25MF	RS232 mini-tester male to female	1	50

## Null Modem



- Replaces two modems when interconnecting two data devices together over short distances
- Units operate within EIA RS232C specifications
- See internal connections schematic

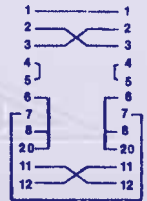

Part Number	Part Description	Std. Pkg. Qty.	Std. Ctn. Qty.
ATNM25FF	Null modem female-to-female	1	50
ATNM25MF	Null modem male-to-female	1	50
ATNM25MM	Null modem male-to-male	1	50

## RS232 Adapter Kit



- Permits two RS232 equipped computers to be connected to each other over short distances without the need for two modems
- Compatible with most RS232 devices
- Supplied in kit form to allow flexibility in wiring schemes
- Wiring diagrams for 6-position and 8-position jacks are illustrated below
- See Page 97 for other wiring diagrams
- UL Listed and CSA Listed

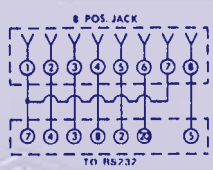
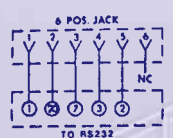

Part Number	Part Description	Std. Pkg. Qty.	Std. Ctn. Qty.
ATRA6F	6-conductor jack to female RS232	1	50
ATRA6F-DEC	6-conductor DEC jack to female RS232	1	50
ATRA6M	6-conductor jack to male RS232	1	50
ATRA6M-DEC	6-conductor DEC jack to male RS232	1	50
ATRA8F	8-conductor jack to female RS232 e/w two 3.50" red straps	1	50
ATRA8M	8-conductor jack to male RS232 e/w two 3.50" red straps	1	50

# Data Accessories



Part Number
ATDB9F-6
ATDB9M-6
ATDB15F-6
ATDB15M-6
ATRA6F
ATRA6M



Part Number
ATDB9F-DEC
ATDB9M-DEC
ATRA6F-DEC
ATRA6M-DEC

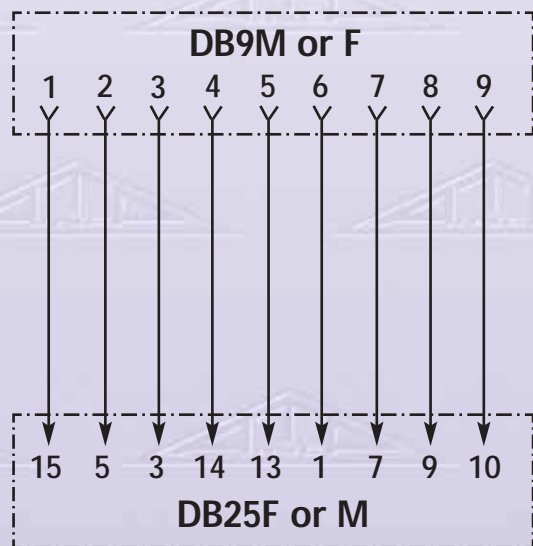

Part Number
ATGC9F25M
ATGC9M25F

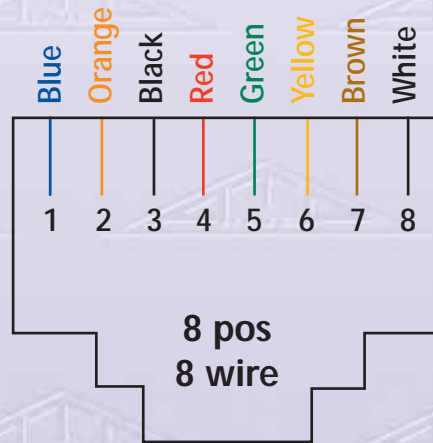

Part Number
ATDB9F-8
ATDB9FS-8
ATDB9M-8
ATDB9MS-8
ATDB15F-8
ATDB15M-8
ATRA8F
ATRA8M
ATRA8FS
ATRA8MS

# Data Accessories

## Computer Cables

- Each cable is shielded against both electromagnetic and radio frequency interference by means of braided copper and aluminum foil
- Connectors and outer cable sheath are molded and bonded together to form an integral assembly providing added strain relief and protection from abrasion
- Conductors are 28 gauge
- Cables are available for interconnection between two specific components of a computer system and cables for more general applications which are wired pin-to-pin

## Monitor Cables

- Cables are terminated at each end in DB9 type connectors either male or female



Part Number	Part Description	Std. Pkg. Qty.	Std. Ctn. Qty.
GBDB9MF-5	Monitor cable 5 ft male-to-female	1	1
GBDB9MF-10	Monitor cable 10 ft male-to-female	1	1
GBDB9MM-10	Monitor cable 10 ft male-to-male	1	1

## Printer Cables

- 8 or 15-foot cables with DB25 male and CN36 terminations
- Used with IBM PC, PS/2 or Apple IIe computers



Part Number	Part Description	Std. Pkg. Qty.	Std. Ctn. Qty.
GBDB25MCN36M-8	Printer cable 8 ft	1	1
GBDB25MCN36M-15	Printer cable 15 ft	1	1

## Printer Cables

- 6 foot cable with DB9 to DB25 terminations
- Used as a printer cable between a Mac computer and a serial printer



Part Number	Part Description	Std. Pkg. Qty.	Std. Ctn. Qty.
GBDB25MDB9M-6	Printer cable 6 ft	1	1

## General Use Cables



Part Number	Part Description	Std. Pkg. Qty.	Std. Ctn. Qty.
GBDB25MF-3	DB25 male to DB25 female 3 ft	1	1
GBDB25MF-5	DB25 male to DB25 female 5 ft	1	1
GBDB25MF-10	DB25 male to DB25 female 10 ft	1	1
GBDB25MF-15	DB25 male to DB25 female 15 ft	1	1
GBDB25MF-25	DB25 male to DB25 female 25 ft	1	1
GBDB25MF-35	DB25 male to DB25 female 35 ft	1	1
GBDB25MF-50	DB25 male to DB25 female 50 ft	1	1
GBDB25MM-3	DB25 male on both ends 3 ft	1	1
GBDB25MM-5	DB25 male on both ends 5 ft	1	1
GBDB25MM-10	DB25 male on both ends 10 ft	1	1
GBDB25MM-15	DB25 male on both ends 15 ft	1	1
GBDB25MM-25	DB25 male on both ends 25 ft	1	1
GBDB25MM-35	DB25 male on both ends 35 ft	1	1
GBDB25MM-50	DB25 male on both ends 50 ft	1	1