

# Impexa 2.4 GHz SMD Antenna

Product Specification

## 1 Features

- Designed for 2.4 GHz applications [Bluetooth™, WiFi™ (802.11b/g), Zigbee™, WiMedia™ etc.]
- Intended for SMD mounting
- Supplied in tape on reel

## 2 Description

The Impexa antenna is intended for use with all 2.4 GHz applications. The antenna requires a groundplane, i.e. your device acts as an active part of the antenna and thus demand careful consideration concerning its placement

## 3 Application

- Mobile phones
- PDAs
- Headsets
- PC-Cards
- CF-Cards

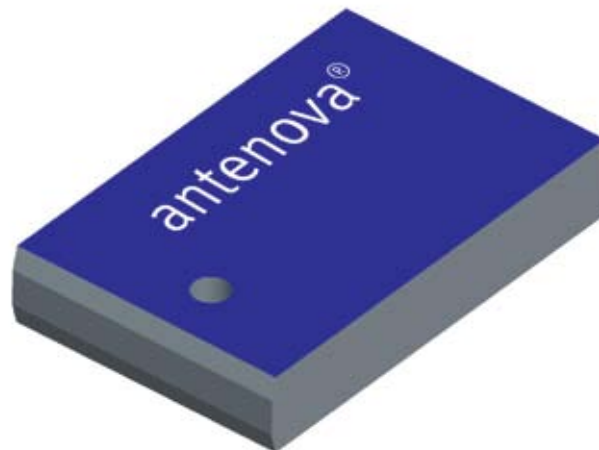

## Contents

1 Features	1
2 Description	1
3 Application	1
4 Model name	3
5 General data	3
6 Electrical characteristics	3
7 Electrical performance	4
7-1 Return loss	4
7-2 Smith diagram	4
7-3 Radiation patterns	4
8 Antenna Dimensions	5
9 Antenna Foot print	5
10 Electrical interface	6
10-1 Transmission line and matching	6
10-2 Test board dimensions	6
10-3 Test board matching	6
11 Soldering	7
11-1 Recommended soldering conditions	7
11-2 Leadfree soldering	7
12 Reliability	7
12-1 Temperature and Humidity	7
12-2 Mechanical	8
12-3 Miscellaneous	8
12-4 Judgement standard	8
13 Hazardous Material Regulation Conformance	8
14 Application example	9
15 Packaging	10
15-1 Shelf storage recommendation	10
15-2 Tape characteristics	10
15-3 Reel dimension	10
15-4 Box dimension	11
15-5 Bag properties	11
15-6 Reel label information	11

## 4 Model name

**30 30 A6150 - 01**

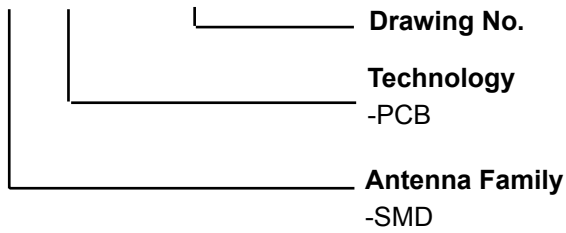

**30 30 A6250 - 01**

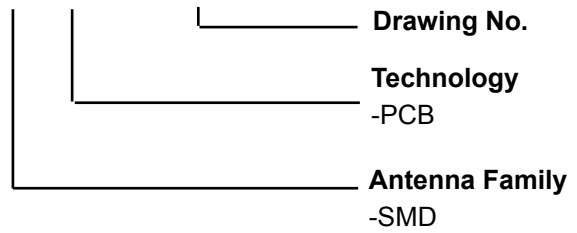

Left feeding

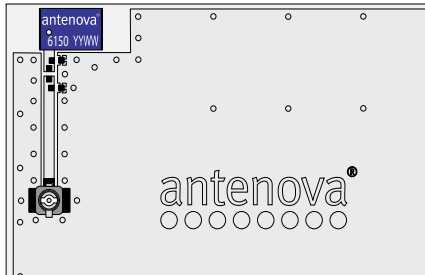

Right feeding

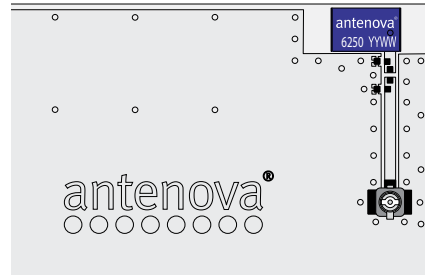

## 5 General data

<b>Product Name</b>	Impexa 2.4 GHz
<b>Article No.</b>	3030A6150-01 Left
	3030A6250-01 Right
<b>Frequency</b>	2.4-2.5 GHz
<b>Polarization</b>	Linear
<b>Operating temperature</b>	-40 to + 85 degC

## 6 Electrical characteristics

	Characteristics			Conditions*
	Min	Typ	Max	
<b>Peak Gain</b>	-1.0 dBi	0.2 dBi	0.9 dBi	Frequency 2.4-2.5 GHz, Measured in 3D chamber (near field)
<b>Efficiency</b>	50%	55%	60%	
<b>VSWR</b>	1.3 : 1	1.5 : 1	1.9 : 1	Frequency 2.4-2.5 GHz, Measured in Network Analyzer

\*Note all data provided in this table are based on the Antenova reference board

## 7 Electrical performance

### 7-1 Return loss

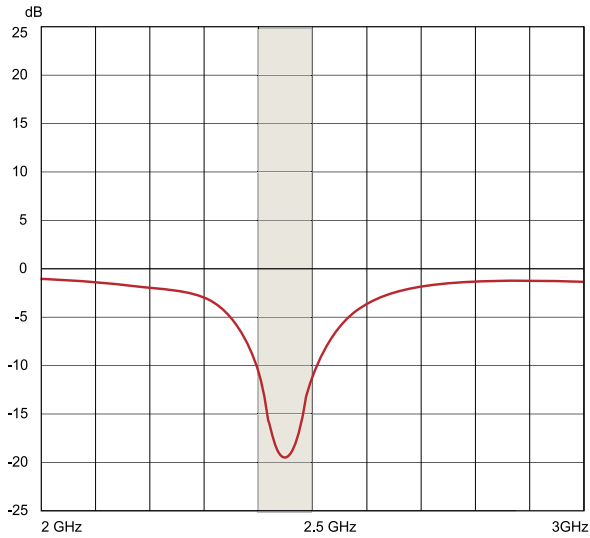

### 7-2 Smith diagram

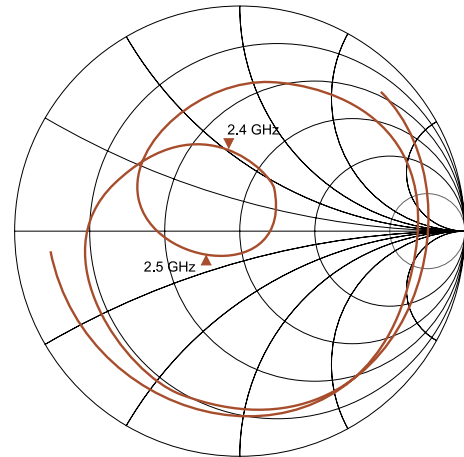

### 7-3 Radiation patterns

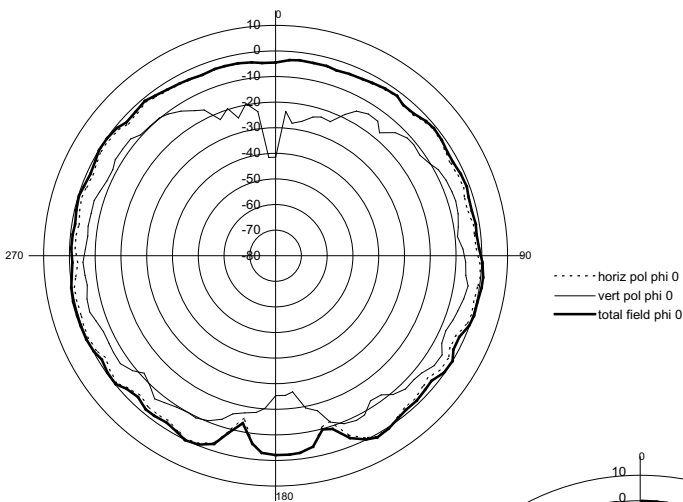

Phi 0 at 2.45 GHz

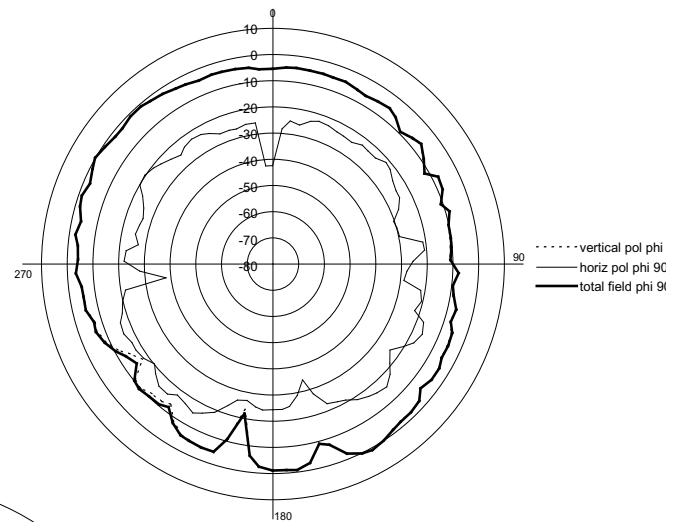

Phi 90 at 2.45 GHz

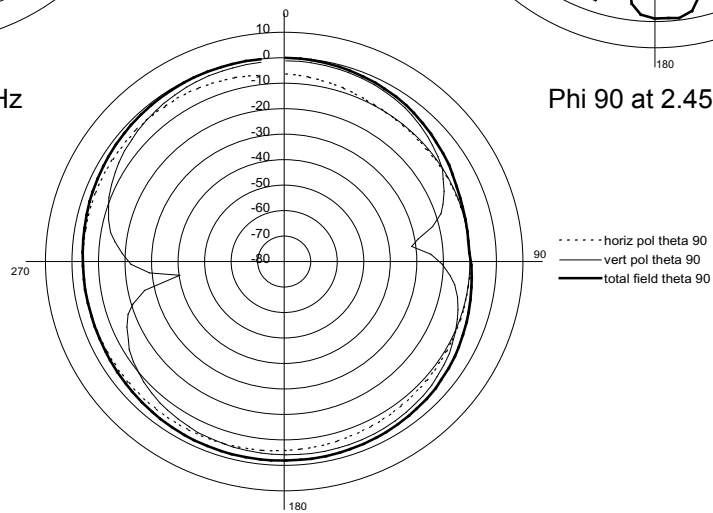

Theta 90 at 2.45 GHz

### 8 Antenna Dimensions

Left variant  
(Art. No :3030A6150-01)

Right variant  
(Art.No :3030A6250-01)

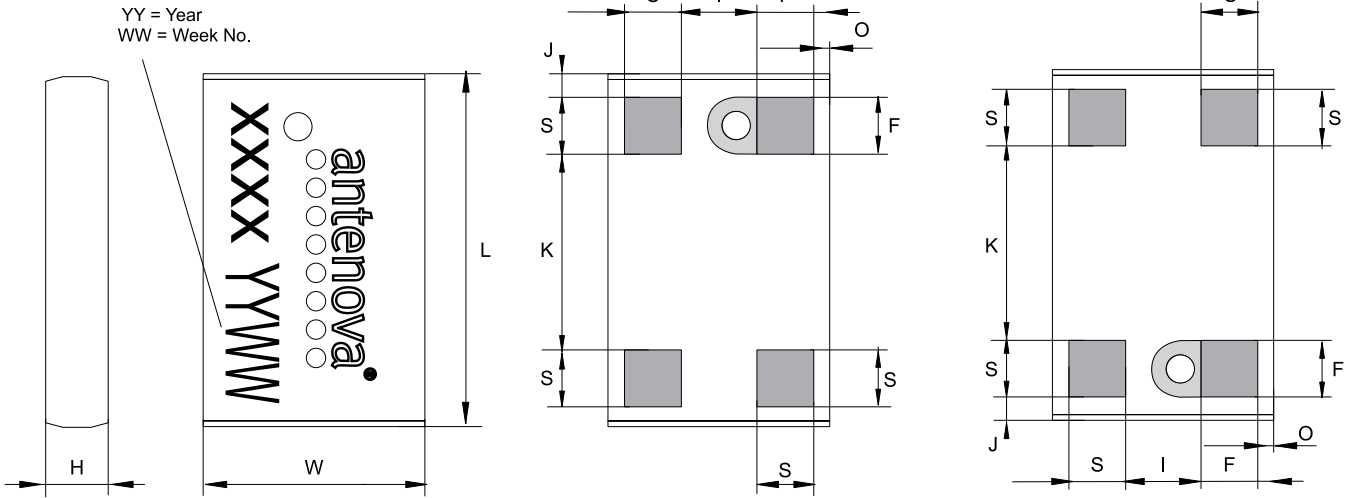

L	W	H	F	S	I	J	K	O
Length	Width	Height	Feed	Solder				
6.1 ±0.2	3.9 ±0.2	1.1±0.15	1.0±0.1		1.3±0.1	0.35±0.1	3.4±0.1	0.3±0.15

Dimensions in millimeters

### 9 Antenna Foot print

Left variant  
(Art. No :3030A6150-01)

Right variant  
(Art.No :3030A6250-01)

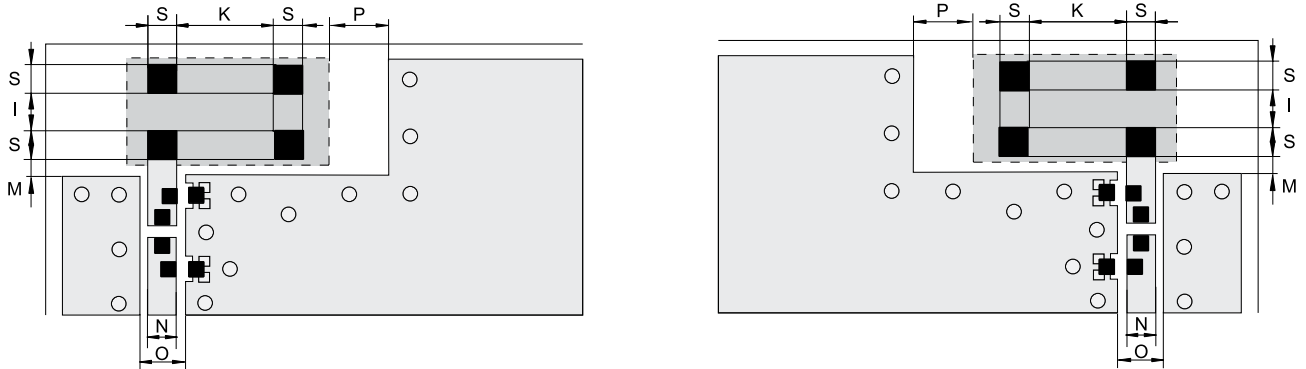

S	F	K	I	M	N	O*	P
Pad							
1.0±0.1	1.0±0.1	3.4±0.1	1.3±0.1	0.5±0.2	1.6±0.05	1.9±0.05	> 2

Dimensions in millimeters

## 10 Electrical interface

### 10-1 Transmission line and matching

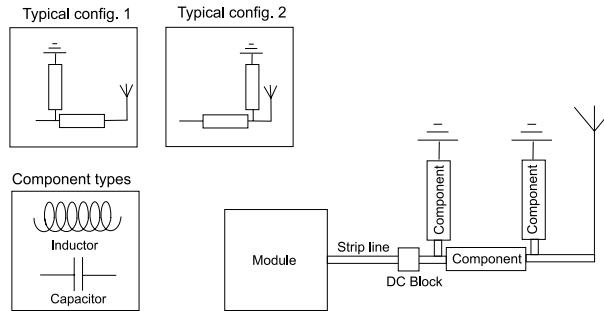

The matching network has to be individually designed using one, two or three components.

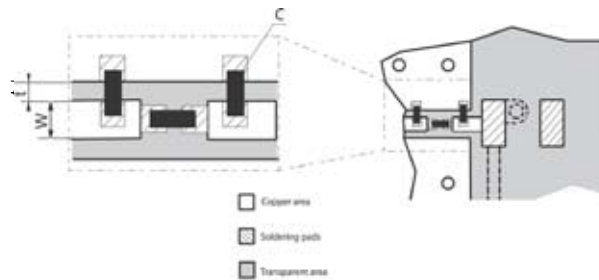

t, w = Unique dimensioning according to your PCB \*

C = Inductor and capacitor values according to your specific device\*

\* Antenna provides this service upon request

### 10-2 Test board dimensions

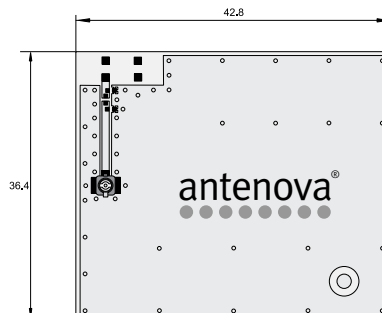

The testboard is designed for evaluation purposes for Impexa 2.4 GHz SMD antenna. The card has the same size as a typical compact flash card and is fitted with an U/FL connector from Hirose.

### 10-3 Test board matching

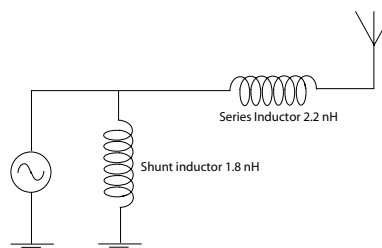

The testboard is matched with above specified component.

**Note! The component value(s) will vary depending on size of PCB, surrounding components etc.**

## 11 Soldering

### 11-1 Recommended soldering conditions

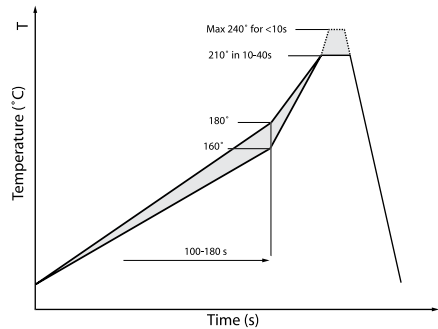

### 11-2 Leadfree soldering

The antenna has been tested and approved for leadfree soldering. The reflow curve and solder paste used is listed below.

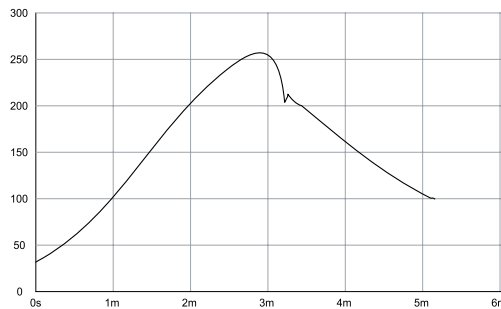

Solder paste: KOKI S3X58-M405

## 12 Reliability

### 12-1 Temperature and Humidity

Item	Standard	Low	High	Duration
Operating temperature	EN/IEC 60068-2-2, Test Bd: Dry heat	-30 degC	+90 degC	-
Temperature cycling	EN/IEC 60068-2-14, Test Na: Change of temperature	-40 degC	+90 degC	500 cycles / 10 min
Storage life Humidity	EN/IEC 60068-2-1, Test Ca: Damp heat	+60 degC / 90% RH		500 h
Storage life Low temperature	EN/IEC 60068-2-1, Test Ad: Cold	-55 degC	-	500 h
Storage life High temperature	EN/IEC 60068-2-2, Test Bb: Dry heat	-	+125 degC	500 h

### 12-2 Mechanical

Item	Standard	Low	High	Duration
Bending	IEC 60068-2-21, Test Ue1: Bending	Bending 1 mm at a rate of 1 mm/s with support at end of PCB 1mm depth on reference board		
Shear	IEC 60068-2-21, Test Ue3: Shear	Force of 5 N applied to the side of the antenna.		
Drop test		Dummy weight: 150g Height: 170cm		One drop at each side, total drops: 6
Vibration	EN/IEC 60068-2-6, Test Fc (sinusoidal)	Acceleration spectral density:10-1000Hz Acceleration: 20m/s <sup>2</sup> Number of axes: 3 mutually perpendicular		5 cycles per axis

### 12-3 Miscellaneous

Item	Standard	Low	High	Duration
Vibration	EN/IEC 60068-2-6, Test Fc (sinusoidal)	Acceleration spectral density:10-1000Hz Acceleration: 20m/s <sup>2</sup> Number of axes: 3 mutually perpendicular		5 cycles per axis
Drop test		Dummy weight: 150g Height: 170cm		One drop at each side, total drops: 6

### 12-4 Judgement standard

The judgement of the above tests should be made as follows:

1. Visual inspection - Normal appearance with no obvious cracking, peeling-off.
2. Electrical inspection - The DUT satisfies the VSWR specification throughout the 2.4-2.5 GHz band

## 13 Hazardous Material Regulation Conformance

Cadmium and cadmium compound.	Lead and lead compound
Organic brominated compound (PBB, PBDE)	Mercury and mercury compound
Polychlorinated biphenyl (PCB)	Sesquivalent chrome compound
Polychlorinated naphthalene (PCN)	Chlorinated paraffin (CP)
Organic tin compound	Mirex
Asbestos	Formaldehyde
Azo compound	Tetra-bromo-bisphenol-A-bis (TBBP-A-bis)



## 14 Application example

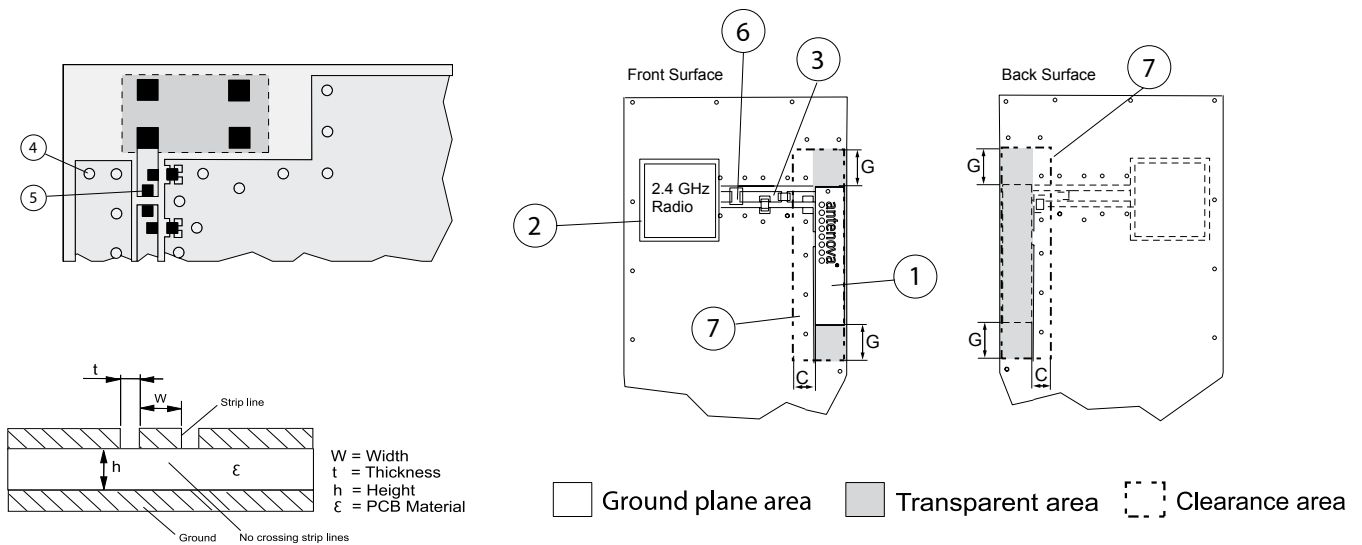

The antenna is of a quarter wave type and is dependent on the groundplane area to complete the antenna function. The antenna performance is also dependent on the size of the groundplane and the transparent area.

### 1. Placement of the antenna

The antenna shall be placed on a transparent area without underlying groundplane at the edge of the PCB oriented as above. Groundplane area surrounding the antenna should be with a clearance of  $G=3-5$  mm

### 2. Placement of 2.4 GHz module

To avoid losses in the strip line, the module shall be placed as close to the antenna as possible.

### 3. Strip line

The strip line must be dimensioned according to your specific PCB. (see fig 1). No crossing strip lines are allowed between the strip line and its ground plane.

### 4. Via Connections

To avoid spurious effects via connections must be made to analogue ground.

### 5. Component matching

Component values are depending on antenna placement, PCB dimensions and location of other components.

### 6. DC Block

Might be needed depending on RF Module configuration.

### 7. Clearance

No components allowed within the clearance area with a minimum distance to other components,  $C= 3-5$  mm.

**Note ! Incorrect implementation of the antenna will affect the performance.  
Contact Antenna for implementation services.**

## 15 Packaging

### 15-1 Shelf storage recommendation

<b>Temperature</b>	-10 to +40 degree C
<b>Humidity</b>	Less than 75% RH
<b>Shelf Life</b>	18 Months
<b>Storage place</b>	Away from corrosive gas and direct sunlight

### 15-2 Tape characteristics

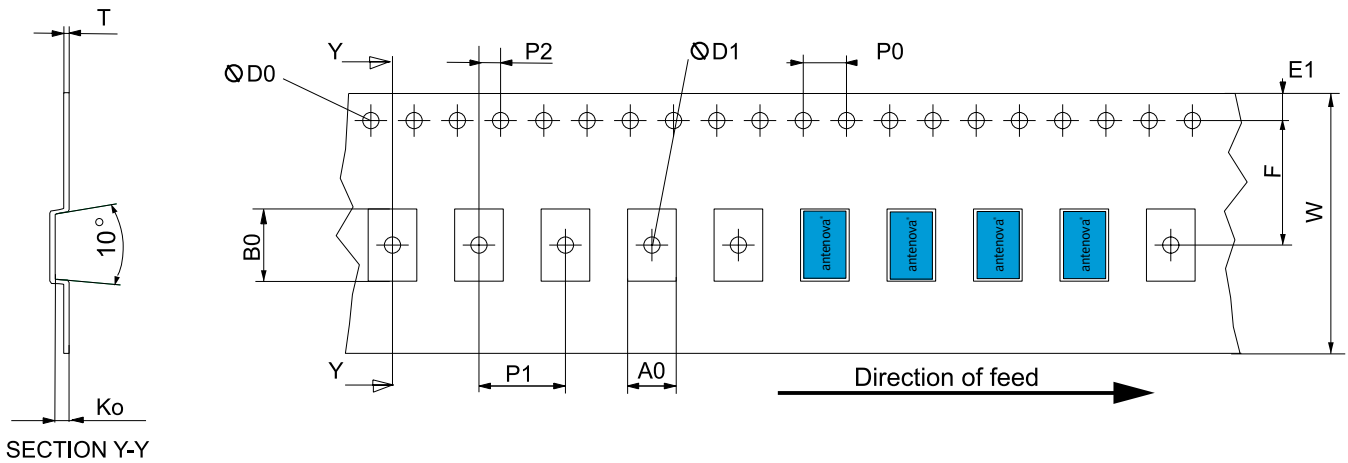

W	F	E <sub>1</sub>	P <sub>0</sub>	P <sub>1</sub>	P <sub>2</sub>	A <sub>0</sub>	B <sub>0</sub>	K <sub>0</sub>	T	D <sub>0</sub>	D <sub>1</sub>
24±0.3	11.5 ±0.1	1.75±0.1	4.0±0.1	8.0±0.1	2.0±0.1	4.3±0.1	6.6±0.1	1.5±0.1	0.3±0.05	1.5±0.1	1.5±0.1

Dimensions in millimeters

Quantity	Leading space	Trailing space
1000 pcs / reel	50 blank antenna holders	37 blank antenna holders

### 15-3 Reel dimension

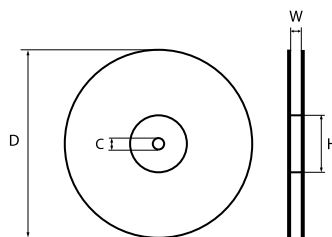

<b>Material:</b>	Conductive Polystyrene
<b>Width [mm]</b>	W: 24
<b>Reel dia [mm]</b>	D: 180(7")
<b>Hub dia [mm]</b>	H: 50(2")
<b>Shaft dia [mm]</b>	C: 13

**15-4 Box dimension**

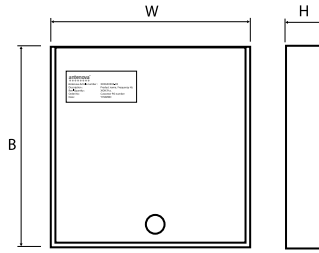

<b>Material:</b>	Cardboard
<b>Width [mm]</b>	W: 195
<b>Breadth [mm]</b>	B: 195
<b>Thickness [mm]</b>	H: 37

**15-5 Bag properties**

Antistatic Aluminium Moisture Barrier Bag  
 Thickness [mil] T: 3.2

**15-6 Reel label information**

Antenna Article number :	XXXXXXXX-XX
Description :	Product name, Frequency Hz
Reel Quantity :	XXXX Pcs.
Order No:	Customer PO number
Date:	YYMMDD



[www.antenova.com](http://www.antenova.com)

**Corporate Headquarters**

**Antenova Ltd.**

Far Field House  
Albert Road  
Stow-cum-Quy  
Cambridge, CB25 9AR  
UK

**Tel:** +44 (0) 1223 810600

**Fax:** +44 (0) 1223 810650

**Email:** [sales@antenova.com](mailto:sales@antenova.com)

**Asia Headquarters**

**Antenova Asia Ltd.**

4F, No. 324, Nei-Hu Dist.  
Nei-Hu Sec. 1  
Taipei, Taiwan  
ROC

**Tel:** +886 (0) 2 8797 8630

**Fax:** +886 (0) 2 8797 6890

**Email:** [sales@antenova.com](mailto:sales@antenova.com)



Certificate No: 4598/04

Integrated Antenna Solutions