

Features

- High Capacitance Ratio,
 $C_{1V}/C_{3V} = 1.8, C_{1V}/C_{6V} = 3.1$
- Low Series Resistance for Low Phase Noise
- Multiple Packages SOT-23, SOD-323, SC-70 and SC-79
- Designed for High Volume Commercial Applications
- Full Characterization with SPICE Models

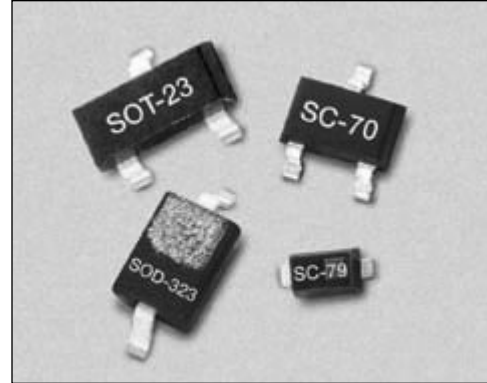

Description

The SMV1232–SMV1237 series of silicon hyperabrupt junction varactor diodes are designed for use in VCOs with low tuning voltage operation. The low resistance of these varactors makes them appropriate for high Q resonators in wireless system VCOs to frequencies beyond 2.5 GHz. The SMV1232–SMV1237 series is fully characterized for capacitance and resistance over temperature. SPICE model is provided.

Absolute Maximum Ratings

Characteristic	Value
Reverse Voltage (V_R)	15 V
Forward Current (I_F)	20 mA
Power Dissipation (P_D)	250 mW
Storage Temperature (T_{ST})	-55°C to +150°C
Operating Temperature (T_{OP})	-55°C to +125°C
ESD Human Body Model	Class 1B

Single	Single	Single	Common Anode	Common Cathode	Common Anode	Common Cathode
SC-79	SOD-323	SOT-23	SOT-23	SOT-23	SC-70	SC-70
† SMV1232-079	† SMV1232-011					† SMV1232-074
† SMV1233-079	† SMV1233-011	† SMV1233-001	† SMV1233-003	† SMV1233-004	† SMV1233-073	† SMV1233-074
† SMV1234-079	† SMV1234-011	† SMV1234-001	† SMV1234-003	† SMV1234-004	† SMV1234-073	† SMV1234-074
† SMV1235-079	† SMV1235-011	† SMV1235-001		† SMV1235-004		† SMV1235-074
† SMV1236-079	† SMV1236-011	† SMV1236-001		† SMV1236-004		† SMV1236-074
		† SMV1237-001		† SMV1237-004		
$L_S = 0.7$ nH	$L_S = 1.5$ nH	$L_S = 1.5$ nH	$L_S = 1.5$ nH	$L_S = 1.5$ nH	$L_S = 1.4$ nH	$L_S = 1.4$ nH

† Available through distribution.
For other packages or configurations, please contact the factory.

Electrical Specifications at 25°C

Part Number	$C_T @ 1V$ (pF)		$C_T @ 3V$ (pF)	$C_T @ 6V$ (pF)	$\frac{C_T @ 1V}{C_T @ 3V}$ (Ratio)		$\frac{C_T @ 1V}{C_T @ 6V}$ (Ratio)		$R_S @ 3V$ 500 MHz (Ω)	$Q @ 3V$ 50 MHz
	Min.	Max.	Typ.	Typ.	Min.	Max.	Min.	Max.	Max.	Typ.
SMV1232	2.34	2.86	1.5	0.94	1.5	1.9	2.6	3.3	1.50	1400
SMV1233	3.00	3.60	1.8	1.10	1.5	1.9	2.6	3.3	1.20	1200
SMV1234	5.85	7.15	3.6	2.00	1.6	2.0	2.8	3.4	0.80	1000
SMV1235	10.35	12.65	6.4	3.60	1.6	2.0	2.9	3.4	0.60	750
SMV1236	15.50	18.50	9.2	5.30	1.6	2.0	3.0	3.5	0.50	700
SMV1237	45.00	54.00	26.9	14.40	1.6	2.0	3.0	3.5	0.25	500

Reverse Voltage V_R ($I_R = 10 \mu A$): 15 V
 Reverse Current I_R ($V_R = 12 V$): 20 nA

Typical Performance Data

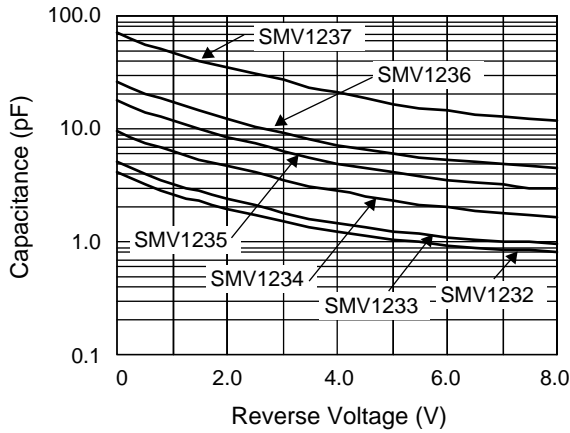

Capacitance vs. Reverse Voltage

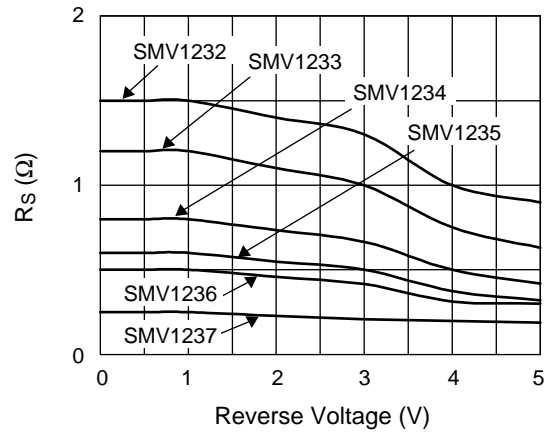

Series Resistance vs. Reverse Voltage @ 500 MHz

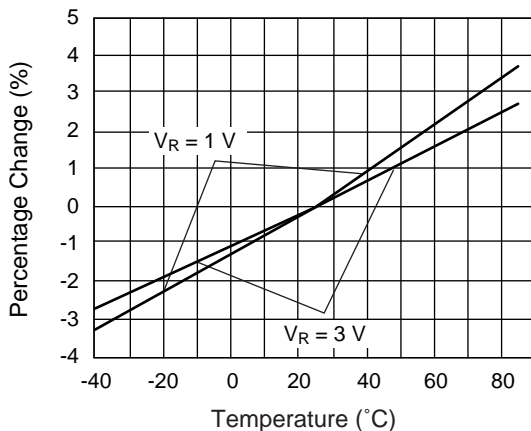

Relative Capacitance Change vs. Temperature

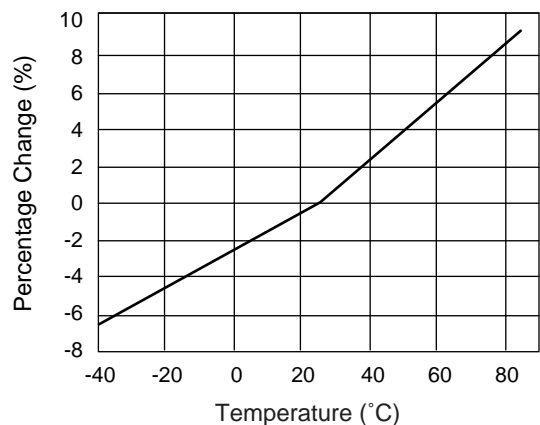

Relative Series Resistance Change vs. Temperature @ 500 MHz

Typical Capacitance Values

V_R (V)	SMV1232	SMV1233	SMV1234	SMV1235	SMV1236	SMV1237
	C_T (pF)	C_T (pF)	C_T (pF)	C_T (pF)	C_T (pF)	C_T (pF)
0.0	4.15	5.08	9.63	18.22	26.75	71.82
0.5	3.22	3.95	7.53	14.12	20.61	56.10
1.0	2.67	3.28	6.28	11.67	17.02	46.89
1.5	2.28	2.80	5.39	9.91	14.38	40.33
2.0	1.97	2.41	4.68	8.52	12.29	35.13
2.5	1.72	2.09	4.09	7.36	10.56	30.71
3.0	1.51	1.82	3.58	6.40	9.16	26.87
3.5	1.35	1.62	3.15	5.62	8.04	23.57
4.0	1.22	1.45	2.81	4.99	7.19	20.83
4.5	1.13	1.33	2.54	4.50	6.53	18.62
5.0	1.05	1.24	2.32	4.11	6.01	16.87
5.5	0.99	1.16	2.15	3.80	5.61	15.48
6.0	0.94	1.10	2.02	3.55	5.28	14.36
6.5	0.90	1.05	1.90	3.34	5.02	13.46
7.0	0.86	1.01	1.80	3.17	4.81	12.72
7.5	0.84	0.98	1.72	3.03	4.64	12.11
8.0	0.81	0.96	1.65	2.91	4.49	11.61
9.0	0.78	0.92	1.55	2.73	4.28	10.87
10.0	0.76	0.90	1.47	2.61	4.13	10.38
11.0	0.75	0.88	1.42	2.53	4.02	10.06
12.0	0.74	0.87	1.38	2.47	3.95	9.84
13.0	0.73	0.86	1.35	2.43	3.89	9.68
14.0	0.73	0.85	1.33	2.40	3.84	9.56
15.0	0.72	0.84	1.32	2.38	3.80	9.47

SPICE Model

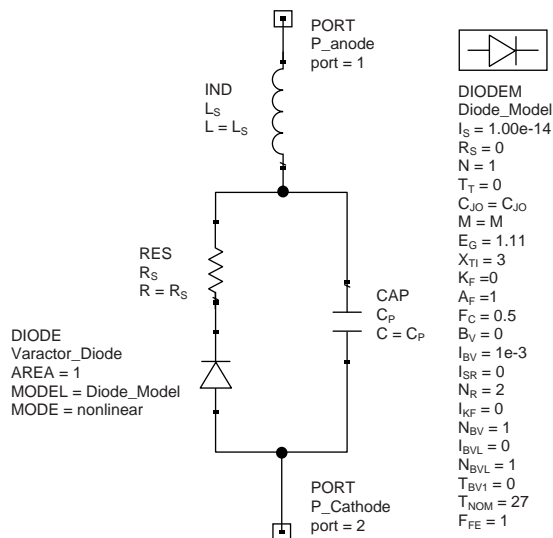

Part Number	C_{j0} (pF)	V_J (V)	M	C_p (pF)	R_s (Ω)
SMV1232	4.20	1.7	0.9	0.0	1.50
SMV1233	4.12	1.7	0.9	0.7	1.20
SMV1234	8.75	2.3	1.1	1.2	0.80
SMV1235	16.13	8.0	4.0	2.0	0.60
SMV1236	21.63	8.0	4.2	3.2	0.50
SMV1237	66.16	10.0	5.3	9.0	0.25

1. Values extracted from measured performance.
2. For package inductance (L_s) refer to package type.
3. For more details refer to the "Varactor SPICE Models for RF VCO Applications" Application Note.

SOT-23

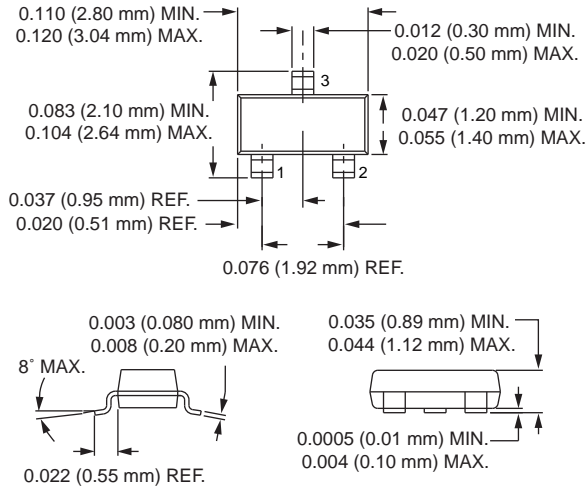

SC-70

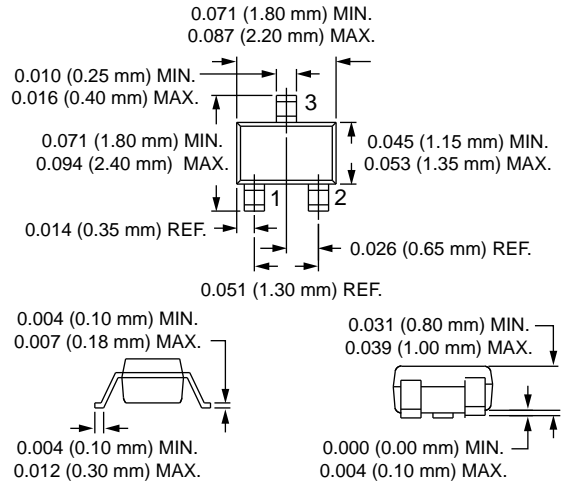

SOD-323

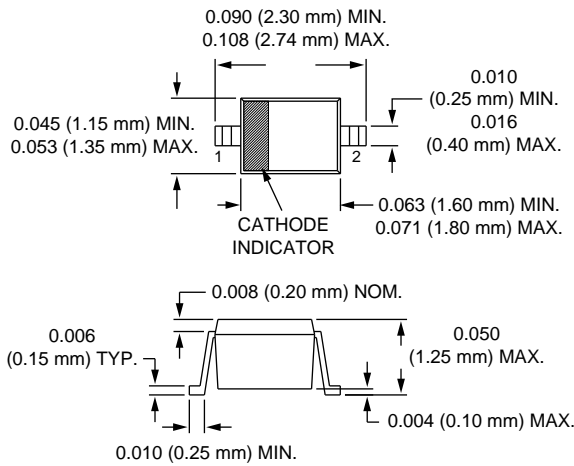

SC-79

