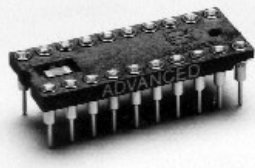
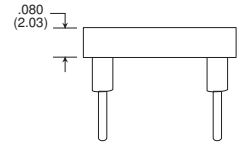

Table of Models



Description: **Decoupling Capacitor Socket (MDC)**
 Material: High Temperature Glass Filled Thermoplastic* U.L. Rated 94V-0
 Index: -60°C to 260°C (-76°F to 500°F)



*Note: This product is not RoHS Compliant.

Standard Terminals

Additional standard and custom terminals available. See Terminals section or consult factory.

Type -01

Low Profile

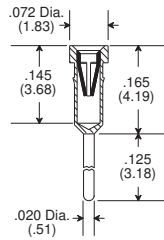

Features:

- Quietest decoupling capacitor socket available.
- Insert molded circuit with committed voltage and ground terminals.
- .014/(.36mm) thick copper circuit offers excellent electrical and thermal conductivity.
- Standard decoupling capacitor values of .01µf, .1µf and .33µf. Other capacitor values available to suit your electrical requirements.
- Mounted height above PCB of .165/(4.19mm).
- Test report available upon request.

Specifications:

Terminals and Contacts:

Terminal: Brass - Copper Alloy (C36000) ASTM-B-16
 Contact: Beryllium Copper - Copper Alloy (C17200) ASTM-B-194
 Circuit: Copper

Plating:

Terminal: G - Gold over Nickel
 T - Tin/Lead over Nickel
 Contact: G - Gold over Nickel
 T - Tin/Lead over Nickel
 Circuit: Tin/Lead*

Gold per ASTM-B-488
 Tin/Lead per MIL-P-81728
 Nickel per QQ-N-290

Dimensional Information

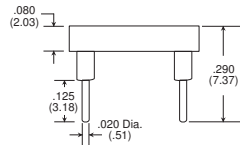
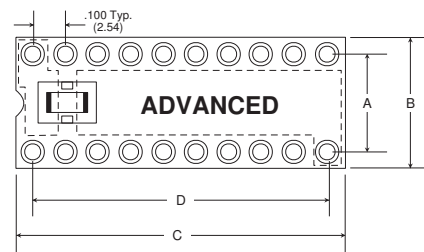

Terminal Type -01 Shown

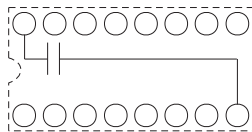

Electrical Schematic

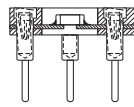

Sectional View of Capacitor

# of Pins	A	B	C	D
14	.300 (7.62)	.400 (10.16)	.700 (17.78)	.600 (15.24)
16	.300 (7.62)	.400 (10.16)	.800 (20.32)	.700 (17.78)
20	.300 (7.62)	.400 (10.16)	1.000 (25.40)	.900 (22.86)
22	.300 (7.62)	.400 (10.16)	1.100 (27.94)	1.000 (25.40)
24	.300 (7.62)	.400 (10.16)	1.200 (30.48)	1.100 (27.94)
24	.600 (15.24)	.700 (17.78)	1.200 (30.48)	1.100 (27.94)
28	.600 (15.24)	.700 (17.78)	1.400 (35.56)	1.300 (33.02)
40	.600 (15.24)	.700 (17.78)	2.000 (50.80)	1.900 (48.26)

Available Online

- Design your own Decoupling Capacitor DIP Socket
- Decoupling Capacitor Socket Effectiveness Study

How To Order

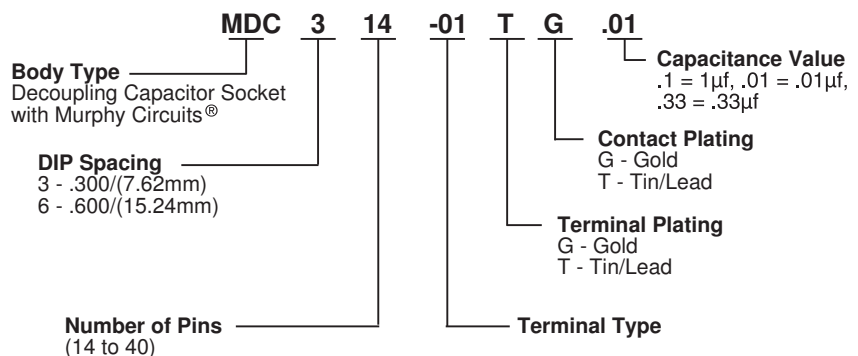

5 Energy Way, West Warwick, RI 02893 USA
 Tel: 800.424.9850 | 401.823.5200
 Fax: 401.823.8723
 info@advanced.com | www.advanced.com
 Catalog 16 rev. Sept. 07