

Chip Monolithic Ceramic Capacitors

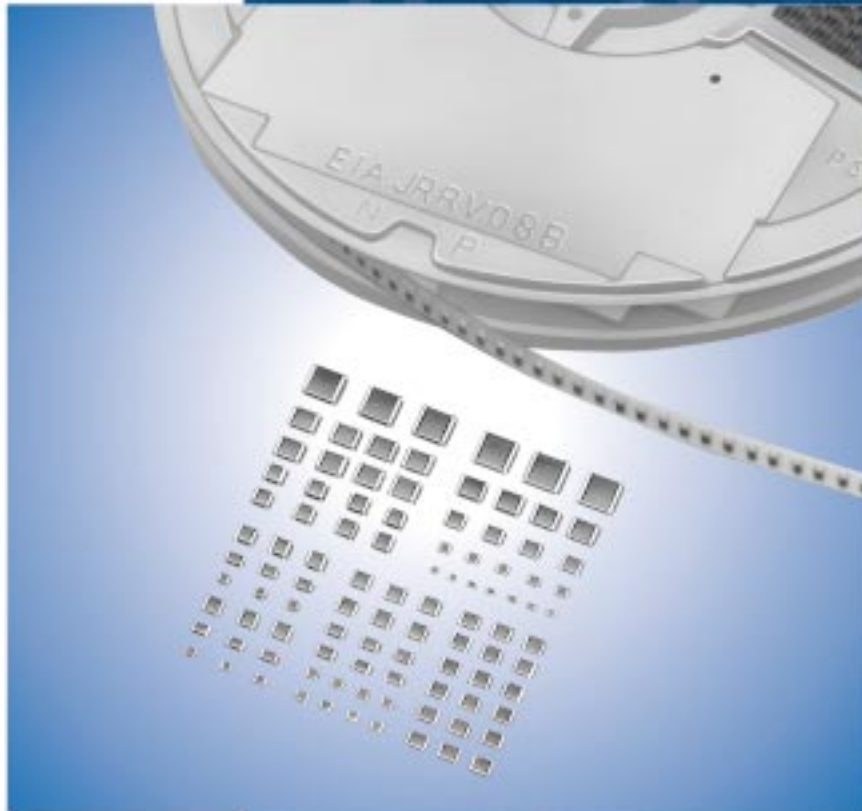

CONTENTS

Part Numbering	_____	2
Selection Guide	_____	6
1 for General Purpose GRM15/18/21/31 Series	_____	7
2 for General Purpose GRM32 Series	_____	15
3 Ultra-small GRM03 Series	_____	17
4 Tight Tolerance GRM03/15 Series	_____	19
5 Thin Type	_____	22
1 to 5 Specifications and Test Methods	_____	24
GRM Series Data	_____	33
6 Microchips GMA Series	_____	35
6 Specifications and Test Methods	_____	36
7 Capacitor Arrays GNM Series	_____	38
7 Specifications and Test Methods	_____	41
8 for Ultrasonic Sensors GRM Series	_____	47
8 Specifications and Test Methods	_____	48
9 Low ESL LLL/LLA/LLM Series	_____	50
9 Specifications and Test Methods	_____	53
10 High-Q GJM Series	_____	57
11 Tight Tolerance High-Q GJM Series	_____	60
10 · 11 Specifications and Test Methods	_____	63
12 High Frequency GQM Series	_____	66
12 Specifications and Test Methods	_____	68
13 High Frequency Type ERB Series	_____	71
13 Specifications and Test Methods	_____	73
ERB Series Data	_____	76
Package	_____	78
△Caution	_____	82
Notice	_____	87
Reference Data	_____	92

14	Medium Voltage Low Dissipation Factor	99
15	Medium Voltage High Capacitance for General Use	103
16	Only for LCD Backlight Inverter Circuit	108
17	Only for Information Devices/Tip & Ring	111
18	Only for Camera Flash Circuit	115
19	AC250V (r.m.s.) Type (Which Meet Japanese Law)	119
20	Safety Standard Recognized Type GC (UL, IEC60384-14 Class X1/Y2)	123
21	Safety Standard Recognized Type GD (IEC60384-14 Class Y3)	124
22	Safety Standard Recognized Type GF (IEC60384-14 Class Y2, X1/Y2)	125
23	Safety Standard Recognized Type GB (IEC60384-14 Class X2)	126
	GA3 Series Specifications and Test Methods	127
	GRM/GR4/GR7/GA2/GA3 Series Data (Typical Example)	131
	Package	134
	⚠Caution	137
	Notice	145
	ISO 9001 Certifications	148

● Please refer to "Specifications and Test Methods" at the end of each chapter of **14** - **19** .



● Part Numbering

Chip Monolithic Ceramic Capacitors

(Part Number)

GR	M	18	8	B1	1H	102	K	A01	K
①	②	③	④	⑤	⑥	⑦	⑧	⑨	⑩

① Product ID

② Series

Product ID	Code	Series
GR	M	Tin Plated Layer
	4	Only for Information Devices / Tip & Ring
	7	Only for Camera Flash Circuit
ER	B	High Frequency Type
GQ	M	High Frequency for Flow/Reflow Soldering
GM	A	Monolithic Microchip
GN	M	Capacitor Array
LL	L	Low ESL Wide Width Type
	A	Eight-termination Low ESL Type
	M	Ten-termination Low ESL Type
GJ	M	High Frequency Low Loss Type Tin Plated Type
GA	2	for AC250V (r.m.s.)
	3	Safety Standard Recognized Type

③ Dimension (L×W)

Code	Dimension (L×W)	EIA
02	0.4×0.2mm	01005
03	0.6×0.3mm	0201
05	0.5×0.5mm	0202
08	0.8×0.8mm	0303
11	1.25×1.0mm	0504
15	1.0×0.5mm	0402
18	1.6×0.8mm	0603
1D	1.4×1.4mm	
1X	Depends on individual standards.	
21	2.0×1.25mm	0805
22	2.8×2.8mm	1111
31	3.2×1.6mm	1206
32	3.2×2.5mm	1210
3X	Depends on individual standards.	
42	4.5×2.0mm	1808
43	4.5×3.2mm	1812
52	5.7×2.8mm	2211
55	5.7×5.0mm	2220

④ Dimension (T)

Code	Dimension (T)
2	0.2mm
2	2-elements (Array Type)
3	0.3mm
4	4-elements (Array Type)
5	0.5mm
6	0.6mm
7	0.7mm
8	0.8mm
9	0.85mm
A	1.0mm
B	1.25mm
C	1.6mm
D	2.0mm
E	2.5mm
F	3.2mm
M	1.15mm
N	1.35mm
R	1.8mm
S	2.8mm
Q	1.5mm
X	Depends on individual standards.

With the array type GNM series, "Dimension(T)" indicates the number of elements.

Continued on the following page.

Continued from the preceding page.

⑤ Temperature Characteristics

Temperature Characteristic Codes			Temperature Characteristics			Operating Temperature Range
Code	Public STD Code	Referance Temperature	Temperature Range	Capacitance Change or Temperature Coefficient		
1X	SL *1	JIS	20°C	20 to 85°C	+350 to -1000ppm/°C	-55 to 125°C
2C	CH *1	JIS	20°C	20 to 125°C	0±60ppm/°C	-55 to 125°C
2P	PH *1	JIS	20°C	20 to 85°C	-150±60ppm/°C	-25 to 85°C
2R	RH *1	JIS	20°C	20 to 85°C	-220±60ppm/°C	-25 to 85°C
2S	SH *1	JIS	20°C	20 to 85°C	-330±60ppm/°C	-25 to 85°C
2T	TH *1	JIS	20°C	20 to 85°C	-470±60ppm/°C	-25 to 85°C
3C	CJ *1	JIS	20°C	20 to 125°C	0±120ppm/°C	-55 to 125°C
3P	PJ *1	JIS	20°C	20 to 85°C	-150±120ppm/°C	-25 to 85°C
3R	RJ *1	JIS	20°C	20 to 85°C	-220±120ppm/°C	-25 to 85°C
3S	SJ *1	JIS	20°C	20 to 85°C	-330±120ppm/°C	-25 to 85°C
3T	TJ *1	JIS	20°C	20 to 85°C	-470±120ppm/°C	-25 to 85°C
3U	UJ *1	JIS	20°C	20 to 85°C	-750±120ppm/°C	-25 to 85°C
4C	CK *1	JIS	20°C	20 to 125°C	0±250ppm/°C	-55 to 125°C
5C	C0G *1	EIA	25°C	25 to 125°C	0±30ppm/°C	-55 to 125°C
5G	X8G *1	EIA	25°C	25 to 150°C	0±30ppm/°C	-55 to 150°C
6C	C0H *1	EIA	25°C	25 to 125°C	0±60ppm/°C	-55 to 125°C
6P	P2H *1	EIA	25°C	25 to 85°C	-150±60ppm/°C	-55 to 125°C
6R	R2H *1	EIA	25°C	25 to 85°C	-220±60ppm/°C	-55 to 125°C
6S	S2H *1	EIA	25°C	25 to 85°C	-330±60ppm/°C	-55 to 125°C
6T	T2H *1	EIA	25°C	25 to 85°C	-470±60ppm/°C	-55 to 125°C
7U	U2J *1	EIA	25°C	25 to 85°C	-750±120ppm/°C	-55 to 125°C
B1	B *2	JIS	20°C	-25 to 85°C	±10%	-25 to 85°C
B3	B	JIS	20°C	-25 to 85°C	±10%	-25 to 85°C
C7	X7S	EIA	25°C	-55 to 125°C	±22%	-55 to 125°C
C8	X6S	EIA	25°C	-55 to 105°C	±22%	-55 to 105°C
F1	F *2	JIS	20°C	-25 to 85°C	+30, -80%	-25 to 85°C
F5	Y5V	EIA	25°C	-30 to 85°C	+22, -82%	-30 to 85°C
L8	X8L	EIA	25°C	-55 to 150°C	+15, -40%	-55 to 150°C
R1	R *2	JIS	20°C	-55 to 125°C	±15%	-55 to 125°C
R3	R	JIS	20°C	-55 to 125°C	±15%	-55 to 125°C
R6	X5R	EIA	25°C	-55 to 85°C	±15%	-55 to 85°C
R7	X7R	EIA	25°C	-55 to 125°C	±15%	-55 to 125°C
R9	X8R	EIA	25°C	-55 to 150°C	±15%	-55 to 150°C
9E	ZLM	*3	20°C	-25 to 20°C	-4700+1000/-2500ppm/°C	-25 to 85°C
				20 to 85°C	-4700+500/-1000ppm/°C	
W0	-	-	25°C	-55 to 125°C	±10% *4	-55 to 125°C
					+22, -33% *5	

*1 Please refer to table for Capacitance Change under reference temperature.

*2 Capacitance change is specified with 50% rated voltage applied.

*3,*4 Murata Temperature Characteristic Code.

*4 Apply DC350V bias.

*5 No DC bias.

Continued on the following page. 

☐ Continued from the preceding page.

● Capacitance Change from each temperature

JIS Code

Murata Code	Capacitance Change from 20°C (%)					
	-55°C		-25°C		-10°C	
	Max.	Min.	Max.	Min.	Max.	Min.
1X	-	-	-	-	-	-
2C	0.82	-0.45	0.49	-0.27	0.33	-0.18
2P	-	-	1.32	0.41	0.88	0.27
2R	-	-	1.70	0.72	1.13	0.48
2S	-	-	2.30	1.22	1.54	0.81
2T	-	-	3.07	1.85	2.05	1.23
3C	1.37	-0.90	0.82	-0.54	0.55	-0.36
3P	-	-	1.65	0.14	1.10	0.09
3R	-	-	2.03	0.45	1.35	0.30
3S	-	-	2.63	0.95	1.76	0.63
3T	-	-	3.40	1.58	2.27	1.05
3U	-	-	4.94	2.84	3.29	1.89
4C	2.56	-1.88	1.54	-1.13	1.02	-0.75

EIA Code

Murata Code	Capacitance Change from 25°C (%)					
	-55°C		-30°C		-10°C	
	Max.	Min.	Max.	Min.	Max.	Min.
5C/5G	0.58	-0.24	0.40	-0.17	0.25	-0.11
6C	0.87	-0.48	0.59	-0.33	0.38	-0.21
6P	2.33	0.72	1.61	0.50	1.02	0.32
6R	3.02	1.28	2.08	0.88	1.32	0.56
6S	4.09	2.16	2.81	1.49	1.79	0.95
6T	5.46	3.28	3.75	2.26	2.39	1.44
7U	8.78	5.04	6.04	3.47	3.84	2.21

⑥ Rated Voltage

Code	Rated Voltage
0G	DC4V
0J	DC6.3V
1A	DC10V
1C	DC16V
1E	DC25V
1H	DC50V
2A	DC100V
2D	DC200V
2E	DC250V
YD	DC300V
2H	DC500V
2J	DC630V
3A	DC1kV
3D	DC2kV
3F	DC3.15kV
BB	DC350V (for Camera Flash Circuit)
E2	AC250V
GB	X2; AC250V (Safety Standard Recognized Type GB)
GC	X1/Y2; AC250V (Safety Standard Recognized Type GC)
GD	Y3; AC250V (Safety Standard Recognized Type GD)
GF	Y2, X1/Y2; AC250V (Safety Standard Recognized Type GF)

⑦ Capacitance

Expressed by three-digit alphanumerics. The unit is pico-farad (pF). The first and second figures are significant digits, and the third figure expresses the number of zeros which follow the two numbers. If there is a decimal point, it is expressed by the capital letter "R". In this case, all figures are significant digits.

Ex.)

Code	Capacitance
R50	0.5pF
1R0	1.0pF
100	10pF
103	10000pF

Continued on the following page. ☐

Please check MURATA home page (<http://www.murata.com/index.html>) in case you can not find the part number on the catalog.

Continued from the preceding page.

⑧ Capacitance Tolerance

Code	Capacitance Tolerance	TC	Series	Capacitance Step	
W	±0.05pF	CΔ	GRM/GJM	≤9.9pF	0.1pF
B	±0.1pF	CΔ	GRM/GJM	≤9.9pF	0.1pF
C	±0.25pF	CΔ	GRM/GJM	≤9.9pF	0.1pF
		except CΔ	GRM	≤5pF	* 1pF
		CΔ	ERB/GQM	≤5pF	* 1pF
D	±0.5pF	CΔ	GRM/GJM	5.1 to 9.9pF	0.1pF
		except CΔ	GRM	5.1 to 9.9pF	* 1pF
		CΔ	ERB/GQM	5.1 to 9.9pF	* 1pF
G	±2%	CΔ	GJM	≥10pF	E12 Series
		CΔ	GQM	≥10pF	E24 Series
J	±5%	CΔ-SL	GRM/GA3	≥10pF	E12 Series
		CΔ	ERB/GQM/GJM	≥10pF	E24 Series
K	±10%	B, R, X7R, X5R, ZLM	GRM/GR7/GA3	E6 Series	
			GR4	E12 Series	
M	±20%	Z5U	GRM	E3 Series	
		B, R, X7R, X7S	GRM/GMA/LLL/LLA/LLM	E6 Series	
		X7R	GA2	E3 Series	
Z	+80%, -20%	F, Y5V	GRM	E3 Series	
R	Depends on individual standards.				

* E24 series is also available.

⑨ Individual Specification Code

Expressed by three figures.

⑩ Packaging

Code	Packaging
L	ø180mm Embossed Taping
D	ø180mm Paper Taping
K	ø330mm Embossed Taping
J	ø330mm Paper Taping
B	Bulk
C	Bulk Case
T	Bulk Tray

Please check MURATA home page (<http://www.murata.com/index.html>) in case you can not find the part number on the catalog.

Selection Guide of Chip Monolithic Ceramic Capacitors

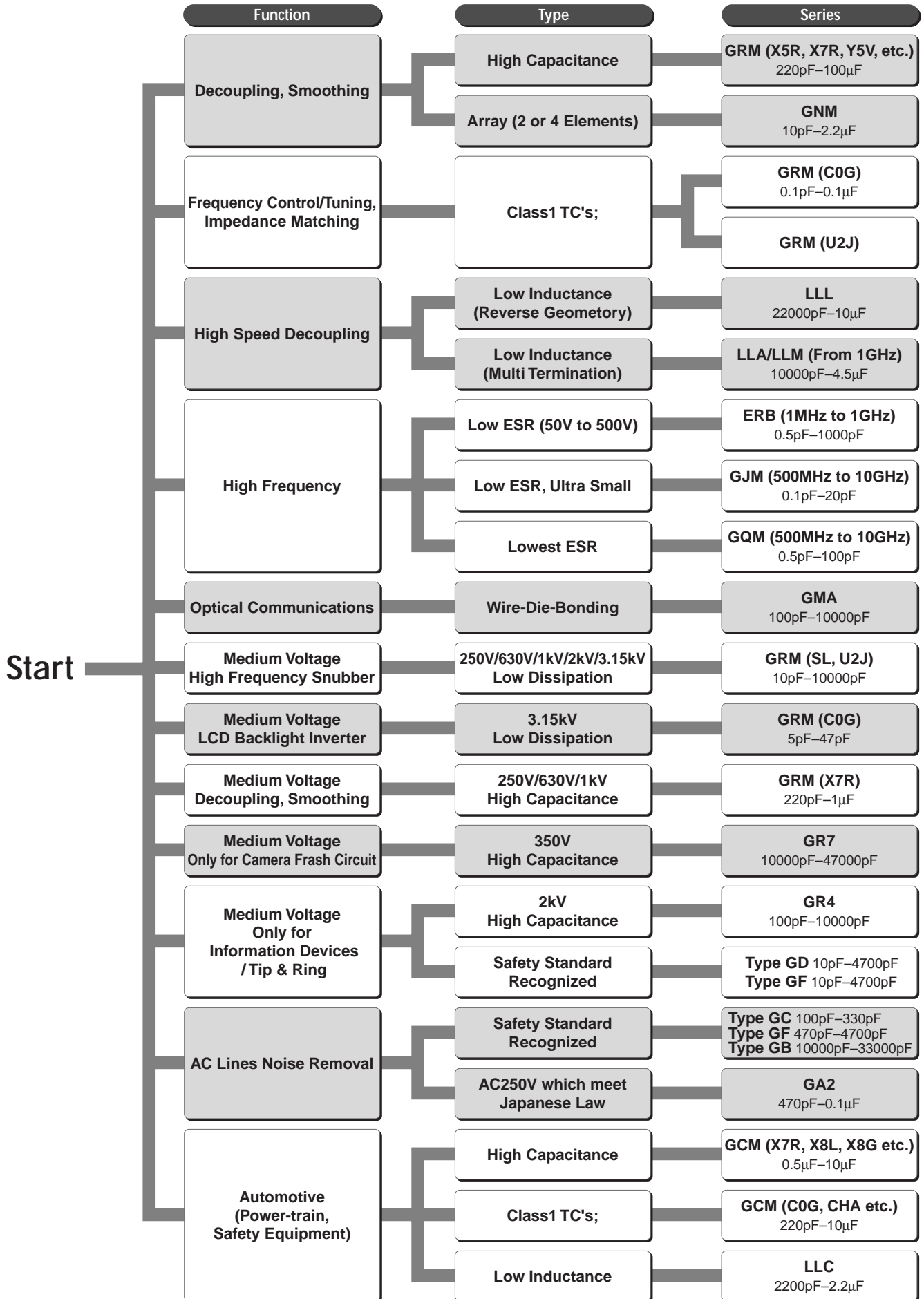

Chip Monolithic Ceramic Capacitors



for General Purpose GRM15/18/21/31 Series

■ Features

1. Terminations are made of metal highly resistant to migration.
2. A wide selection of sizes is available, from the miniature LxW: 1.0x0.5mm to LxW: 3.2x1.6mm. GRM18, 21 and GRM31 types are suited to flow and reflow soldering. GRM15 type is applied to only reflow soldering.
3. Smaller size and higher capacitance value
4. High reliability and no polarity
5. Excellent pulse responsibility and noise reduction due to the low impedance at high frequency.
6. Ta replacement

■ Applications

General electronic equipment

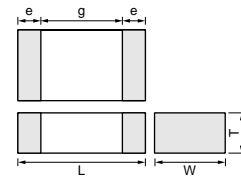

Part Number	Dimensions (mm)				
	L	W	T	e	g min.
GRM155	1.0 ±0.05	0.5 ±0.05	0.5 ±0.05	0.15 to 0.35	0.3
GRM185	1.6 ±0.1	0.8 ±0.1	0.5 +0/-0.1	0.2 to 0.5	0.5
GRM188*			0.8 ±0.1		
GRM216	2.0 ±0.1	1.25 ±0.1	0.6 ±0.1	0.2 to 0.7	0.7
GRM219			0.85 ±0.1		
GRM21A			1.0 +0/-0.2		
GRM21B			1.25 ±0.1		
GRM316	3.2 ±0.15	1.6 ±0.15	0.6 ±0.1	0.3 to 0.8	1.5
GRM319			0.85 ±0.1		
GRM31M			1.15 ±0.1		
GRM31C	3.2 ±0.2	1.6 ±0.2	1.6 ±0.2		

* Bulk Case : 1.6 ±0.07(L) × 0.8 ±0.07(W) × 0.8 ±0.07(T)

Temperature Compensating Type GRM15 Series (1.00x0.50mm) 50/25V

Part Number	GRM15							
L x W [EIA]	1.0x0.5 [0402]							
TC	COG (5C)	P2H (6P)	R2H (6R)	S2H (6S)	SL (1X)		T2H (6T)	U2J (7U)
Rated Volt.	50 (1H)	50 (1H)	50 (1H)	50 (1H)	50 (1H)	25 (1E)	50 (1H)	50 (1H)
Capacitance (Capacitance part numbering code) and T (mm) Dimension (T Dimension part numbering code)								
3.0pF(3R0)	0.5(5)	0.5(5)	0.5(5)	0.5(5)			0.5(5)	0.5(5)
4.0pF(4R0)	0.5(5)	0.5(5)	0.5(5)	0.5(5)			0.5(5)	0.5(5)
5.0pF(5R0)	0.5(5)	0.5(5)	0.5(5)	0.5(5)			0.5(5)	0.5(5)
6.0pF(6R0)	0.5(5)	0.5(5)	0.5(5)	0.5(5)			0.5(5)	0.5(5)
7.0pF(7R0)	0.5(5)	0.5(5)	0.5(5)	0.5(5)			0.5(5)	0.5(5)
8.0pF(8R0)	0.5(5)	0.5(5)	0.5(5)	0.5(5)			0.5(5)	0.5(5)
9.0pF(9R0)	0.5(5)	0.5(5)	0.5(5)	0.5(5)			0.5(5)	0.5(5)
10pF(100)	0.5(5)	0.5(5)	0.5(5)	0.5(5)			0.5(5)	0.5(5)
12pF(120)	0.5(5)	0.5(5)	0.5(5)	0.5(5)	0.5(5)	0.5(5)	0.5(5)	0.5(5)
15pF(150)	0.5(5)	0.5(5)	0.5(5)	0.5(5)	0.5(5)	0.5(5)	0.5(5)	0.5(5)
18pF(180)	0.5(5)	0.5(5)	0.5(5)	0.5(5)	0.5(5)	0.5(5)	0.5(5)	0.5(5)
22pF(220)	0.5(5)	0.5(5)	0.5(5)	0.5(5)	0.5(5)	0.5(5)	0.5(5)	0.5(5)
27pF(270)	0.5(5)	0.5(5)	0.5(5)	0.5(5)	0.5(5)	0.5(5)	0.5(5)	0.5(5)
33pF(330)	0.5(5)		0.5(5)	0.5(5)	0.5(5)	0.5(5)	0.5(5)	0.5(5)
39pF(390)	0.5(5)			0.5(5)	0.5(5)	0.5(5)	0.5(5)	0.5(5)
47pF(470)	0.5(5)				0.5(5)	0.5(5)	0.5(5)	0.5(5)
56pF(560)	0.5(5)				0.5(5)	0.5(5)	0.5(5)	0.5(5)
68pF(680)	0.5(5)				0.5(5)	0.5(5)	0.5(5)	0.5(5)
82pF(820)	0.5(5)				0.5(5)	0.5(5)	0.5(5)	0.5(5)
100pF(101)	0.5(5)				0.5(5)	0.5(5)	0.5(5)	0.5(5)
120pF(121)	0.5(5)				0.5(5)	0.5(5)		0.5(5)
150pF(151)	0.5(5)				0.5(5)	0.5(5)		0.5(5)
180pF(181)	0.5(5)				0.5(5)	0.5(5)		0.5(5)
220pF(221)	0.5(5)					0.5(5)		
270pF(271)	0.5(5)					0.5(5)		

Continued on the following page.

1

Continued from the preceding page.

Part Number	GRM15							
L x W [EIA]	1.0x0.5 [0402]							
TC	COG (5C)	P2H (6P)	R2H (6R)	S2H (6S)	SL (1X)		T2H (6T)	U2J (7U)
Rated Volt.	50 (1H)	50 (1H)	50 (1H)	50 (1H)	50 (1H)	25 (1E)	50 (1H)	50 (1H)
Capacitance (Capacitance part numbering code) and T (mm) Dimension (T Dimension part numbering code)								
330pF(331)	0.5(5)					0.5(5)		
390pF(391)	0.5(5)					0.5(5)		
470pF(471)	0.5(5)							
560pF(561)	0.5(5)							
680pF(681)	0.5(5)							
820pF(821)	0.5(5)							
1000pF(102)	0.5(5)							

The part numbering code is shown in ().

Dimensions are shown in mm and Rated Voltage in Vdc.

Temperature Compensating Type GRM18 Series (1.60x0.80mm) 100/50V

Part Number	GRM18													
L x W [EIA]	1.6x0.8 [0603]													
TC	COG (5C)		P2H (6P)		R2H (6R)		S2H (6S)		SL (1X)		T2H (6T)		U2J (7U)	
Rated Volt.	100 (2A)	50 (1H)	100 (2A)	50 (1H)	100 (2A)	50 (1H)	100 (2A)	50 (1H)	100 (2A)	50 (1H)	100 (2A)	50 (1H)	100 (2A)	50 (1H)
Capacitance (Capacitance part numbering code) and T (mm) Dimension (T Dimension part numbering code)														
0.50pF(R50)	0.8(8)													
3.0pF(3R0)	0.8(8)		0.8(8)		0.8(8)		0.8(8)				0.8(8)			
4.0pF(4R0)	0.8(8)		0.8(8)		0.8(8)		0.8(8)				0.8(8)			
5.0pF(5R0)	0.8(8)		0.8(8)		0.8(8)		0.8(8)				0.8(8)			
6.0pF(6R0)	0.8(8)		0.8(8)		0.8(8)		0.8(8)				0.8(8)			
7.0pF(7R0)	0.8(8)		0.8(8)		0.8(8)		0.8(8)				0.8(8)			
8.0pF(8R0)	0.8(8)		0.8(8)		0.8(8)		0.8(8)				0.8(8)			
9.0pF(9R0)	0.8(8)		0.8(8)		0.8(8)		0.8(8)				0.8(8)			
10pF(100)	0.8(8)		0.8(8)		0.8(8)		0.8(8)				0.8(8)		0.8(8)	
12pF(120)	0.8(8)		0.8(8)		0.8(8)		0.8(8)		0.8(8)		0.8(8)		0.8(8)	
15pF(150)	0.8(8)		0.8(8)		0.8(8)		0.8(8)		0.8(8)		0.8(8)		0.8(8)	
18pF(180)	0.8(8)		0.8(8)		0.8(8)		0.8(8)		0.8(8)		0.8(8)		0.8(8)	
22pF(220)	0.8(8)		0.8(8)		0.8(8)		0.8(8)		0.8(8)		0.8(8)		0.8(8)	
27pF(270)	0.8(8)		0.8(8)		0.8(8)		0.8(8)		0.8(8)		0.8(8)		0.8(8)	
33pF(330)	0.8(8)		0.8(8)	0.8(8)	0.8(8)		0.8(8)		0.8(8)		0.8(8)		0.8(8)	
39pF(390)	0.8(8)		0.8(8)	0.8(8)	0.8(8)	0.8(8)	0.8(8)		0.8(8)		0.8(8)		0.8(8)	
47pF(470)	0.8(8)		0.8(8)	0.8(8)	0.8(8)	0.8(8)	0.8(8)	0.8(8)	0.8(8)				0.8(8)	
56pF(560)	0.8(8)		0.8(8)	0.8(8)	0.8(8)	0.8(8)	0.8(8)	0.8(8)	0.8(8)				0.8(8)	
68pF(680)	0.8(8)		0.8(8)	0.8(8)	0.8(8)	0.8(8)	0.8(8)	0.8(8)	0.8(8)				0.8(8)	
82pF(820)	0.8(8)		0.8(8)	0.8(8)	0.8(8)	0.8(8)	0.8(8)	0.8(8)	0.8(8)				0.8(8)	
100pF(101)	0.8(8)		0.8(8)	0.8(8)	0.8(8)	0.8(8)	0.8(8)	0.8(8)	0.8(8)				0.8(8)	
120pF(121)	0.8(8)		0.8(8)	0.8(8)	0.8(8)	0.8(8)	0.8(8)	0.8(8)	0.8(8)			0.8(8)	0.8(8)	
150pF(151)	0.8(8)			0.8(8)	0.8(8)	0.8(8)		0.8(8)	0.8(8)			0.8(8)	0.8(8)	
180pF(181)	0.8(8)					0.8(8)		0.8(8)	0.8(8)			0.8(8)	0.8(8)	
220pF(221)	0.8(8)							0.8(8)	0.8(8)	0.8(8)		0.8(8)	0.8(8)	0.8(8)
270pF(271)	0.8(8)								0.8(8)	0.8(8)		0.8(8)	0.8(8)	0.8(8)
330pF(331)	0.8(8)								0.8(8)	0.8(8)		0.8(8)	0.8(8)	0.8(8)
390pF(391)	0.8(8)								0.8(8)	0.8(8)		0.8(8)	0.8(8)	0.8(8)
470pF(471)	0.8(8)									0.8(8)		0.8(8)		0.8(8)
560pF(561)	0.8(8)									0.8(8)				0.8(8)
680pF(681)	0.8(8)									0.8(8)				0.8(8)
820pF(821)	0.8(8)													

Continued on the following page. ↗

Continued from the preceding page.

Part Number	GRM18													
L x W [EIA]	1.6x0.8 [0603]													
TC	C0G (5C)		P2H (6P)		R2H (6R)		S2H (6S)		SL (1X)		T2H (6T)		U2J (7U)	
Rated Volt.	100 (2A)	50 (1H)	100 (2A)	50 (1H)	100 (2A)	50 (1H)	100 (2A)	50 (1H)	100 (2A)	50 (1H)	100 (2A)	50 (1H)	100 (2A)	50 (1H)
Capacitance (Capacitance part numbering code) and T (mm) Dimension (T Dimension part numbering code)														
1000pF(102)	0.8(8)										0.8(8)			0.8(8)
1200pF(122)		0.8(8)									0.8(8)			0.8(8)
1500pF(152)		0.8(8)									0.8(8)			0.8(8)
1800pF(182)		0.8(8)									0.8(8)			0.8(8)
2200pF(222)		0.8(8)									0.8(8)			0.8(8)
2700pF(272)		0.8(8)									0.8(8)			0.8(8)
3300pF(332)											0.8(8)			0.8(8)
3900pF(392)											0.8(8)			0.8(8)
4700pF(472)											0.8(8)			0.8(8)
5600pF(562)											0.8(8)			0.8(8)
6800pF(682)											0.8(8)			0.8(8)
8200pF(822)											0.8(8)			0.8(8)
10000pF(103)											0.8(8)			0.8(8)

The part numbering code is shown in ().
 Dimensions are shown in mm and Rated Voltage in Vdc.

Temperature Compensating Type GRM21 Series (2.00x1.25mm) 100/50V

Part Number	GRM21													
L x W [EIA]	2.0x1.25 [0805]													
TC	C0G (5C)		P2H (6P)		R2H (6R)		S2H (6S)		SL (1X)		T2H (6T)		U2J (7U)	
Rated Volt.	100 (2A)	50 (1H)	100 (2A)	50 (1H)	100 (2A)	50 (1H)	100 (2A)	50 (1H)	100 (2A)	50 (1H)	100 (2A)	50 (1H)	100 (2A)	50 (1H)
Capacitance (Capacitance part numbering code) and T (mm) Dimension (T Dimension part numbering code)														
33pF(330)				0.6(6)										
39pF(390)				0.6(6)		0.6(6)								
47pF(470)				0.6(6)		0.6(6)		0.6(6)			1.25(B)			
56pF(560)				0.6(6)		0.6(6)		0.6(6)			1.25(B)			
68pF(680)				0.6(6)		0.6(6)		0.6(6)			1.25(B)			
82pF(820)				0.6(6)		0.6(6)		0.6(6)			1.25(B)			
100pF(101)				0.6(6)		0.6(6)		0.6(6)			1.25(B)			
120pF(121)				0.6(6)		0.6(6)		0.6(6)			1.25(B)	0.6(6)		
150pF(151)			0.85(9)	0.6(6)		0.6(6)	0.85(9)	0.6(6)			1.25(B)			
180pF(181)			0.85(9)	0.85(9)	0.85(9)	0.6(6)	0.85(9)	0.6(6)			1.25(B)			
220pF(221)			0.85(9)	0.85(9)	0.85(9)	0.85(9)	0.85(9)	0.6(6)		0.6(6)	1.25(B)			0.6(6)
270pF(271)			0.85(9)	0.85(9)	0.85(9)	0.85(9)	0.85(9)			0.6(6)				0.6(6)
330pF(331)			0.85(9)	0.85(9)	0.85(9)	0.85(9)	0.85(9)			0.6(6)				0.6(6)
390pF(391)			1.25(B)	1.25(B)	0.85(9)	0.85(9)	0.85(9)			0.6(6)				0.6(6)
470pF(471)			1.25(B)	1.25(B)	0.85(9)	0.85(9)	0.85(9)		0.85(9)	0.6(6)			0.85(9)	0.6(6)
560pF(561)				1.25(B)	1.25(B)	0.85(9)	1.25(B)	0.85(9)	0.85(9)	0.6(6)		1.25(B)	0.85(9)	0.6(6)
680pF(681)	0.6(6)					1.25(B)		1.25(B)	0.85(9)	0.6(6)		1.25(B)	0.85(9)	0.6(6)
820pF(821)	0.6(6)							1.25(B)	1.25(B)	0.6(6)		1.25(B)	1.25(B)	0.6(6)
1000pF(102)	0.85(9)								1.25(B)	0.6(6)		1.25(B)	1.25(B)	0.6(6)
1200pF(122)	0.85(9)	0.6(6)							1.25(B)	0.6(6)		1.25(B)	1.25(B)	0.6(6)
1500pF(152)	0.85(9)	0.6(6)							1.25(B)	0.85(9)		1.25(B)	1.25(B)	0.85(9)
1800pF(182)		0.6(6)							1.25(B)	0.85(9)		1.25(B)	1.25(B)	0.85(9)
2200pF(222)		0.6(6)								0.85(9)				0.85(9)
2700pF(272)		0.6(6)								1.25(B)				1.25(B)
3300pF(332)		0.6(6)								1.25(B)				1.25(B)
3900pF(392)		0.6(6)												

Continued on the following page.

1

Continued from the preceding page.

Part Number	GRM21													
L x W [EIA]	2.0x1.25 [0805]													
TC	COG (5C)		P2H (6P)		R2H (6R)		S2H (6S)		SL (1X)		T2H (6T)		U2J (7U)	
Rated Volt.	100 (2A)	50 (1H)	100 (2A)	50 (1H)	100 (2A)	50 (1H)	100 (2A)	50 (1H)	100 (2A)	50 (1H)	100 (2A)	50 (1H)	100 (2A)	50 (1H)
Capacitance (Capacitance part numbering code) and T (mm) Dimension (T Dimension part numbering code)														
4700pF(472)		0.6(6)												
5600pF(562)		0.85(9)												
6800pF(682)		0.85(9)												
8200pF(822)		0.85(9)												
10000pF(103)		0.85(9)								0.6(6)				0.6(6)
12000pF(123)		0.85(9)								0.6(6)				0.6(6)
15000pF(153)		0.85(9)								0.6(6)				0.6(6)
18000pF(183)		1.25(B)								0.6(6)				0.6(6)
22000pF(223)		1.25(B)								0.85(9)				0.85(9)
27000pF(273)										0.85(9)				0.85(9)
33000pF(333)										1.0(A)				1.0(A)
39000pF(393)										1.25(B)				1.25(B)
47000pF(473)										1.25(B)				1.25(B)

The part numbering code is shown in ().
 Dimensions are shown in mm and Rated Voltage in Vdc.

Temperature Compensating Type GRM31 Series (3.20x1.60mm) 100/50/25V

Part Number	GRM31															
L x W [EIA]	3.2x1.6 [1206]															
TC	COG (5C)			P2H (6P)		R2H (6R)		S2H (6S)		SL (1X)		T2H (6T)		U2J (7U)		
Rated Volt.	100 (2A)	50 (1H)	25 (1E)	100 (2A)	50 (1H)	100 (2A)	50 (1H)	100 (2A)	50 (1H)	100 (2A)	50 (1H)	100 (2A)	50 (1H)	100 (2A)	50 (1H)	
Capacitance (Capacitance part numbering code) and T (mm) Dimension (T Dimension part numbering code)																
47pF(470)												0.85(9)				
56pF(560)												0.85(9)				
68pF(680)												0.85(9)				
82pF(820)												0.85(9)				
100pF(101)												1.15(M)				
120pF(121)												1.15(M)				
150pF(151)												1.15(M)				
180pF(181)					0.6(6)							1.15(M)				
220pF(221)					0.6(6)		0.6(6)					1.15(M)				
270pF(271)					0.6(6)		0.6(6)		0.6(6)			1.15(M)				
330pF(331)					0.6(6)		0.6(6)		0.6(6)			1.15(M)				
390pF(391)				0.85(9)			0.6(6)		0.6(6)			1.15(M)				
470pF(471)				0.85(9)					0.6(6)			1.15(M)				
560pF(561)				0.85(9)		0.85(9)		0.85(9)	0.85(9)							
680pF(681)				0.85(9)		0.85(9)	0.85(9)	0.85(9)	0.85(9)							
820pF(821)				0.85(9)		0.85(9)	0.85(9)	0.85(9)	0.85(9)	0.85(9)			1.15(M)	0.85(9)		
1000pF(102)				1.15(M)		1.15(M)	1.15(M)	0.85(9)	0.85(9)	0.85(9)			1.15(M)	0.85(9)		
1200pF(122)				1.15(M)		1.15(M)	1.15(M)	1.15(M)	1.15(M)	0.85(9)			1.15(M)	0.85(9)		
1500pF(152)					1.15(M)		1.15(M)	1.15(M)	1.15(M)	0.85(9)			1.15(M)	0.85(9)		
1800pF(182)	0.85(9)									1.15(M)	0.85(9)		1.15(M)	0.85(9)		
2200pF(222)	0.85(9)									1.15(M)			1.15(M)	1.15(M)		
2700pF(272)	0.85(9)									1.15(M)			1.15(M)	1.15(M)		
3300pF(332)	0.85(9)									1.15(M)			1.15(M)	1.15(M)		
3900pF(392)	0.85(9)									1.15(M)			1.15(M)	1.15(M)		
4700pF(472)	0.85(9)									1.15(M)				1.15(M)		
5600pF(562)	0.85(9)															

Continued on the following page.

Continued from the preceding page.

Part Number	GRM31															
L x W [EIA]	3.2x1.6 [1206]															
TC	C0G (5C)			P2H (6P)		R2H (6R)		S2H (6S)		SL (1X)		T2H (6T)		U2J (7U)		
Rated Volt.	100 (2A)	50 (1H)	25 (1E)	100 (2A)	50 (1H)	100 (2A)	50 (1H)	100 (2A)	50 (1H)	100 (2A)	50 (1H)	100 (2A)	50 (1H)	100 (2A)	50 (1H)	
Capacitance (Capacitance part numbering code) and T (mm) Dimension (T Dimension part numbering code)																
18000pF(183)		0.85(9)														
22000pF(223)		0.85(9)														
27000pF(273)		0.85(9)														
33000pF(333)		0.85(9)														
39000pF(393)		1.15(M)														
47000pF(473)		1.15(M)														
56000pF(563)		1.6(C)									0.85(9)					0.85(9)
68000pF(683)		1.6(C)									1.15(M)					1.15(M)
82000pF(823)		1.6(C)									1.15(M)					1.15(M)
0.10μF(104)			1.6(C)								1.15(M)					1.15(M)

The part numbering code is shown in ().
 Dimensions are shown in mm and Rated Voltage in Vdc.

High Dielectric Constant Type X5R (R6) Characteristics

TC	X5R (R6)																			
Part Number	GRM15					GRM18					GRM21					GRM31				
L x W [EIA]	1.0x0.5 [0402]					1.6x0.8 [0603]					2.0x1.25 [0805]					3.2x1.6 [1206]				
Rated Volt.	50 (1H)	25 (1E)	16 (1C)	10 (1A)	6.3 (0J)	50 (1H)	25 (1E)	16 (1C)	10 (1A)	6.3 (0J)	25 (1E)	16 (1C)	10 (1A)	6.3 (0J)	25 (1E)	16 (1C)	10 (1A)	6.3 (0J)	4 (0G)	
Capacitance (Capacitance part numbering code) and T (mm) Dimension (T Dimension part numbering code)																				
1000pF (102)	0.5 (5)	0.5 (5)																		
2200pF (222)	0.5 (5)	0.5 (5)																		
4700pF (472)	0.5 (5)	0.5 (5)																		
10000pF (103)						0.8 (8)														
22000pF (223)			0.5 (5)			0.8 (8)														
33000pF (333)			0.5 (5)	0.5 (5)																
47000pF (473)			0.5 (5)	0.5 (5)																
68000pF (683)			0.5 (5)	0.5 (5)																
0.10μF (104)			0.5 (5)	0.5 (5)		0.8 (8)														
0.15μF (154)				0.5* (5)	0.5* (5)															
0.22μF (224)				0.5* (5)	0.5* (5)	0.8 (8)	0.8 (8)													
0.33μF (334)				0.5* (5)	0.5* (5)															
0.47μF (474)				0.5* (5)	0.5* (5)	0.8* (8)	0.8* (8)													
0.68μF (684)				0.5* (5)	0.5* (5)															

Continued on the following page. ↗

1

Continued from the preceding page.

TC	X5R (R6)																			
Part Number	GRM15					GRM18					GRM21					GRM31				
L x W [EIA]	1.0x0.5 [0402]					1.6x0.8 [0603]					2.0x1.25 [0805]					3.2x1.6 [1206]				
Rated Volt.	50 (1H)	25 (1E)	16 (1C)	10 (1A)	6.3 (0J)	50 (1H)	25 (1E)	16 (1C)	10 (1A)	6.3 (0J)	25 (1E)	16 (1C)	10 (1A)	6.3 (0J)	25 (1E)	16 (1C)	10 (1A)	6.3 (0J)	4 (0G)	
Capacitance (Capacitance part numbering code) and T (mm) Dimension (T Dimension part numbering code)																				
1.0μF (105)				0.5* (5)	0.5* (5)			0.8* (8)	0.8* (8)											
2.2μF (225)								0.8* (8)	0.8* (8)	0.8* (8)	1.25* (B)						1.15 (M)			
3.3μF (335)									0.8* (8)		1.25* (B)	1.25* (B)					1.6 (C)			
4.7μF (475)										0.8* (8)	1.25* (B)	1.25* (B)	1.25* (B)		1.6 (C)	1.6 (C)	1.6 (C)			
10μF (106)													1.25* (B)	1.25* (B)	1.6* (C)	1.6 (C)				
15μF (156)																			1.6* (C)	
22μF (226)														1.25* (B)					1.6* (C)	
47μF (476)																			1.6* (C)	
100μF (107)																			1.6* (C)	1.6* (C)

The part numbering code is shown in each ().

3.3μF and 4.7μF, 6.3V rated are GRM21 series of L: 2±0.15, W: 1.25±0.15, T: 1.25±0.15.

T: 1.15±0.1mm is also available for GRM31 1.0μF for 16V.

L: 3.2±0.2, W: 1.6±0.2 for GRM31 16V 1.0μF type. Also L: 3.2±0.2, W: 1.6±0.2, T: 1.15±0.15 for GRM31 16V 1.5μF and 2.2μF type.

Dimensions are shown in mm and Rated Voltage in Vdc.

*: Please refer to GRM Series Specifications and Test Methods (2) (P.30).

High Dielectric Constant Type X6S (C8) Characteristics

TC	X6S (C8)											
Part Number	GRM15		GRM18		GRM21				GRM31			
L x W [EIA]	1.0x0.5 [0402]		1.6x0.8 [0603]		2.0x1.25 [0805]				3.2x1.6 [1206]			
Rated Volt.	6.3 (0J)	4 (0G)	6.3 (0J)	4 (0G)	25 (1E)	16 (1C)	6.3 (0J)	4 (0G)	10 (1A)	6.3 (0J)	4 (0G)	
Capacitance (Capacitance part numbering code) and T (mm) Dimension (T Dimension part numbering code)												
0.15μF(154)	0.5*(5)											
0.22μF(224)	0.5*(5)											
0.33μF(334)	0.5*(5)											
0.47μF(474)	0.5*(5)											
0.68μF(684)		0.5*(5)	0.8*(8)									
1.0μF(105)		0.5*(5)										
2.2μF(225)			0.8*(8)									
4.7μF(475)				0.8*(8)	1.25*(B)	1.25*(B)						
10μF(106)							1.25*(B)		1.15*(M)			
22μF(226)								1.25*(B)		1.6*(C)	1.6*(C)	
47μF(476)												1.6*(C)

The part numbering code is shown in ().

Dimensions are shown in mm and Rated Voltage in Vdc.

*: Please refer to GRM Series Specifications and Test Methods (2) (P.30).

High Dielectric Constant Type X7R (R7) Characteristics

TC	X7R (R7)																								
Part Number	GRM15					GRM18						GRM21						GRM31							
L x W [EIA]	1.0x0.5 [0402]					1.6x0.8 [0603]						2.0x1.25 [0805]						3.2x1.6 [1206]							
Rated Volt.	100 (2A)	50 (1H)	25 (1E)	16 (1C)	10 (1A)	100 (2A)	50 (1H)	25 (1E)	16 (1C)	10 (1A)	6.3 (0J)	100 (2A)	50 (1H)	25 (1E)	16 (1C)	10 (1A)	6.3 (0J)	100 (2A)	50 (1H)	25 (1E)	16 (1C)	10 (1A)			
Capacitance (Capacitance part numbering code) and T (mm) Dimension (T Dimension part numbering code)																									
220pF (221)	0.5 (5)					0.8 (8)																			
330pF (331)	0.5 (5)					0.8 (8)																			
470pF (471)	0.5 (5)					0.8 (8)																			
680pF (681)	0.5 (5)					0.8 (8)																			
1000pF (102)	0.5 (5)					0.8 (8)																			
1500pF (152)	0.5 (5)					0.8 (8)																			
2200pF (222)	0.5 (5)					0.8 (8)																			
3300pF (332)	0.5 (5)					0.8 (8)																			
4700pF (472)	0.5 (5)	0.5 (5)										0.85 (9)													
6800pF (682)	0.5 (5)	0.5 (5)										0.85 (9)													
10000pF (103)	0.5 (5)	0.5 (5)										1.25 (B)													
15000pF (153)		0.5 (5)	0.5 (5)			0.8 (8)						1.25 (B)													
22000pF (223)		0.5 (5)	0.5 (5)			0.8 (8)						1.25 (B)													
33000pF (333)		0.5 (5)	0.5 (5)	0.5 (5)		0.8 (8)						1.25 (B)													
47000pF (473)		0.5 (5)	0.5 (5)	0.5 (5)		0.8 (8)						1.25 (B)													
68000pF (683)			0.5 (5)	0.5 (5)		0.8 (8)	0.8 (8)												1.15 (M)						
0.10μF (104)			0.5 (5)	0.5 (5)		0.8 (8)	0.8 (8)																		
0.15μF (154)							0.8 (8)	0.8 (8)					1.25 (B)										1.15 (M)		
0.22μF (224)							0.8 (8)	0.8 (8)	0.8 (8)			1.0 (A)	1.25 (B)										0.85 (9)		
0.33μF (334)								0.8 (8)	0.8 (8)			1.0 (A)	0.85 (9)	1.25 (B)											
0.47μF (474)							0.8* (8)	0.8 (8)	0.8 (8)	0.8 (8)			1.25 (B)	0.85 (9)									1.15 (M)		
0.68μF (684)									0.8 (8)					0.85 (9)	0.85 (9)										
1.0μF (105)								0.8* (8)	0.8* (8)	0.8* (8)				1.25 (B)	1.25 (B)							1.6 (C)	1.15 (M)	1.15 (M)	
1.5μF (155)														1.25 (B)	1.25 (B)								1.6 (C)	1.15 (M)	1.15 (M)

Continued on the following page.

Continued from the preceding page.

TC	X7R (R7)																									
Part Number	GRM15					GRM18					GRM21					GRM31										
L x W [EIA]	1.0x0.5 [0402]					1.6x0.8 [0603]					2.0x1.25 [0805]					3.2x1.6 [1206]										
Rated Volt.	100 (2A)	50 (1H)	25 (1E)	16 (1C)	10 (1A)	100 (2A)	50 (1H)	25 (1E)	16 (1C)	10 (1A)	6.3 (0J)	100 (2A)	50 (1H)	25 (1E)	16 (1C)	10 (1A)	6.3 (0J)	100 (2A)	50 (1H)	25 (1E)	16 (1C)	10 (1A)				
Capacitance (Capacitance part numbering code) and T (mm) Dimension (T Dimension part numbering code)																										
2.2μF (225)											0.8* (8)						1.25* (B)	1.25* (B)				1.6 (C)		1.15 (M)		
3.3μF (335)																								1.6 (C)	1.6 (C)	
4.7μF (475)																								1.6 (C)	1.6 (C)	1.6 (C)
10μF (106)																								1.6* (C)		

The part numbering code is shown in each ().

The tolerance will be changed to L: 3.2±0.2, W: 1.6±0.2 for GRM31 16V 1.0μF type. Also L: 3.2±0.2, W: 1.6±0.2, T: 1.15±0.15 for GRM31 16V 1.5μF and 2.2μF type. Dimensions are shown in mm and Rated Voltage in Vdc.

*: Please refer to GRM Series Specifications and Test Methods (2) (P.30).

High Dielectric Constant Type X7S (C7) Characteristics

TC	X7S (C7)								
Part Number	GRM18			GRM21			GRM31		
L x W [EIA]	1.6x0.8 [0603]			2.0x1.25 [0805]			3.2x1.6 [1206]		
Rated Volt.	6.3 (0J)			10 (1A)			4 (0G)		
Capacitance (Capacitance part numbering code) and T (mm) Dimension (T Dimension part numbering code)									
2.2μF(225)	0.8*(8)								
3.3μF(335)				1.25*(B)					
22μF(226)							1.6*(C)		

The part numbering code is shown in ().

Dimensions are shown in mm and Rated Voltage in Vdc.

*: Please refer to GRM Series Specifications and Test Methods (2) (P.30).

High Dielectric Constant Type Y5V (F5) Characteristics

TC	Y5V (F5)											
Part Number	GRM15				GRM18				GRM21		GRM31	
L x W [EIA]	1.0x0.5 [0402]				1.6x0.8 [0603]				2.0x1.25 [0805]		3.2x1.6 [1206]	
Rated Volt.	50 (1H)	25 (1E)	16 (1C)	10 (1A)	6.3 (0J)	50 (1H)	25 (1E)	50 (1H)	25 (1E)	50 (1H)	6.3 (0J)	
Capacitance (Capacitance part numbering code) and T (mm) Dimension (T Dimension part numbering code)												
1000pF(102)	0.5(5)											
2200pF(222)	0.5(5)											
4700pF(472)	0.5(5)											
10000pF(103)	0.5(5)					0.8(8)						
22000pF(223)		0.5(5)				0.8(8)						
47000pF(473)		0.5(5)	0.5(5)			0.8(8)						
0.10μF(104)		0.5(5)	0.5(5)			0.8(8)		0.85(9)	0.6(6)			
0.22μF(224)			0.5(5)			0.8(8)	0.8(8)		0.85(9)			
0.47μF(474)			0.5(5)	0.5(5)			0.8(8)	0.85(9)	0.6(6)	1.15(M)		
1.0μF(105)				0.5*(5)	0.5*(5)							
100μF(107)											1.6*(C)	

The part numbering code is shown in each ().

T: 1.25±0.1mm is also available for GRM21 25V or 16V 1.0μF type.

Dimensions are shown in mm and Rated Voltage in Vdc.

*: Please refer to GRM Series Specifications and Test Methods (2) (P.30).

Chip Monolithic Ceramic Capacitors



for General Purpose GRM32 Series

■ Features

1. Terminations are made of metal highly resistant to migration.
2. Smaller size and higher capacitance value
3. High reliability and no polarity
4. Excellent pulse responsibility and noise reduction due to the low impedance at high frequency.
5. Ta replacement

■ Applications

General electronic equipment

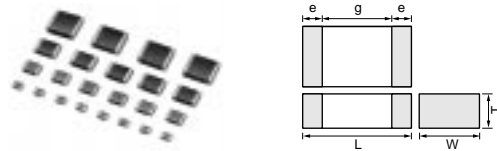

Part Number	Dimensions (mm)				
	L	W	T	e	g min.
GRM329	3.2 ±0.3	2.5 ±0.2	0.85 ±0.1	0.3 min.	1.0
GRM32A			1.0 +0/-0.2		
GRM32M			1.15 ±0.1		
GRM32N			1.35 ±0.15		
GRM32C			1.6 ±0.2		
GRM32R			1.8 ±0.2		
GRM32D			2.0 ±0.2		
GRM32E			2.5 ±0.2		

Temperature Compensating Type GRM32 Series

Part Number	TC Code (Standard)	Rated Voltage (Vdc)	Capacitance (pF)	Length L (mm)	Width W (mm)	Thickness T (mm)
GRM3291X2A222JZ01	SL (JIS)	100	2200 ±5%	3.2	2.5	0.85
GRM3291X2A272JZ01	SL (JIS)	100	2700 ±5%	3.2	2.5	0.85
GRM3291X2A332JZ01	SL (JIS)	100	3300 ±5%	3.2	2.5	0.85
GRM32N1X2A562JZ01	SL (JIS)	100	5600 ±5%	3.2	2.5	1.35
GRM32N1X2A682JZ01	SL (JIS)	100	6800 ±5%	3.2	2.5	1.35

High Dielectric Constant Type GRM32 Series (3.20x2.50mm)

Part Number	TC Code (Standard)	Rated Voltage (Vdc)	Capacitance (μF)	Length L (mm)	Width W (mm)	Thickness T (mm)
GRM32ER61E226ME15	X5R (EIA)	25	22 ±20%*	3.2	2.5	2.5
GRM32ER61C226ME20	X5R (EIA)	16	22 ±20%*	3.2	2.5	2.5
GRM32ER61C476ME15	X5R (EIA)	16	47 ±20%*	3.2	2.5	2.5
GRM32ER61A226ME20	X5R (EIA)	10	22 ±20%*	3.2	2.5	2.5
GRM32ER61A476ME20	X5R (EIA)	10	47 ±20%*	3.2	2.5	2.5
GRM32DR60J226KA01	X5R (EIA)	6.3	22 ±10%*	3.2	2.5	2.0
GRM32DR60J336ME19	X5R (EIA)	6.3	33 ±20%*	3.2	2.5	2.0
GRM32ER60J476ME20	X5R (EIA)	6.3	47 ±20%*	3.2	2.5	2.5
GRM32ER60J107ME20	X5R (EIA)	6.3	100 ±20%*	3.2	2.5	2.5
GRM32DC81E106KA12	X6S(EIA)	25	10 ±10%	3.2	2.5	2.0
GRM32EC80J476ME64	X6S(EIA)	6.3	47 ±20%*	3.2	2.5	2.5
GRM32EC80G107ME20	X6S(EIA)	4	100 ±20%*	3.2	2.5	2.5
GRM32CR72A684KA01	X7R (EIA)	100	0.68 ±10%	3.2	2.5	1.6
GRM32CR72A105KA35	X7R (EIA)	100	1.0 ±10%	3.2	2.5	1.6
GRM32DR72A155KA35	X7R (EIA)	100	1.5 ±10%	3.2	2.5	2.0
GRM32ER72A225KA35	X7R (EIA)	100	2.2 ±10%*	3.2	2.5	2.5
GRM32ER71H105KA01	X7R (EIA)	50	1.0 ±10%	3.2	2.5	2.5
GRM32DR71H335KA88	X7R (EIA)	50	3.3 ±10%	3.2	2.5	2.0
GRM32ER71H475KA88	X7R (EIA)	50	4.7 ±10%	3.2	2.5	2.5
GRM32DR71E335KA01	X7R (EIA)	25	3.3 ±10%	3.2	2.5	2.0
GRM32DR71E475KA61	X7R (EIA)	25	4.7 ±10%	3.2	2.5	2.0
GRM32DR71E106KA12	X7R (EIA)	25	10 ±10%	3.2	2.5	2.0

Continued on the following page.

 Continued from the preceding page.

Part Number	TC Code (Standard)	Rated Voltage (Vdc)	Capacitance (μF)	Length L (mm)	Width W (mm)	Thickness T (mm)
GRM32ER71C226ME18	X7R (EIA)	16	22 ±20%*	3.2	2.5	2.5
GRM32ER71A226ME20	X7R (EIA)	10	22 ±20%*	3.2	2.5	2.5
GRM32EF50J107ZE20	Y5V (EIA)	6.3	100 +80/-20%*	3.2	2.5	2.5

*: Please refer to GRM Series Specifications and Test Methods (2) (P.30).

Chip Monolithic Ceramic Capacitors



Ultra-small GRM03 Series

■ Features

1. Small chip size (LxWxT: 0.6x0.3x0.3mm)
2. Terminations are made of metal highly resistant to migration.
3. GRM03 series is suited to only reflow soldering.
4. Stringent dimensional tolerances allow highly reliable, high speed automatic chip placement on PCBs.
5. GRM03 series is suited to miniature microwave module, portable equipment and high frequency circuits.

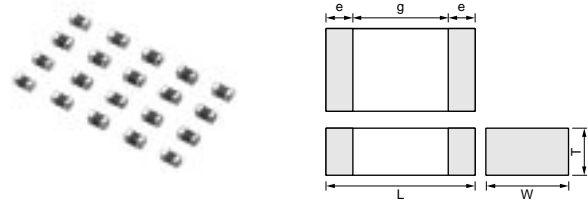

Part Number	Dimensions (mm)				
	L	W	T	e	g min.
GRM033	0.6 ±0.03	0.3 ±0.03	0.3 ±0.03	0.1 to 0.2	0.2

■ Applications

1. Miniature microwave module
2. Portable equipment
3. High frequency circuit

Part Number	GRM03											
L x W	0.6x0.3 [0201]											
TC	C0G (5C)	R2H (6R)	S2H (6S)	T2H (6T)	U2J (7U)		X5R (R6)		X6S (C8)	X7R (R7)		
Rated Volt.	25 (1E)	25 (1E)	25 (1E)	25 (1E)	50 (1H)	25 (1E)	10 (1A)	6.3 (0J)	4 (0G)	25 (1E)	16 (1C)	10 (1A)
Capacitance (Capacitance part numbering code) and T (mm) Dimension (T Dimension part numbering code)												
1.0pF(1R0)	0.3(3)	0.3(3)	0.3(3)	0.3(3)								
2.0pF(2R0)	0.3(3)	0.3(3)	0.3(3)	0.3(3)								
3.0pF(3R0)	0.3(3)	0.3(3)	0.3(3)	0.3(3)	0.3(3)							
4.0pF(4R0)	0.3(3)	0.3(3)	0.3(3)	0.3(3)	0.3(3)							
5.0pF(5R0)	0.3(3)	0.3(3)	0.3(3)	0.3(3)	0.3(3)							
6.0pF(6R0)	0.3(3)	0.3(3)	0.3(3)	0.3(3)	0.3(3)							
7.0pF(7R0)	0.3(3)	0.3(3)	0.3(3)	0.3(3)	0.3(3)							
8.0pF(8R0)	0.3(3)	0.3(3)	0.3(3)	0.3(3)	0.3(3)							
9.0pF(9R0)	0.3(3)	0.3(3)	0.3(3)	0.3(3)	0.3(3)							
10pF(100)	0.3(3)	0.3(3)	0.3(3)	0.3(3)	0.3(3)							
12pF(120)	0.3(3)	0.3(3)	0.3(3)	0.3(3)	0.3(3)							
15pF(150)	0.3(3)	0.3(3)	0.3(3)	0.3(3)	0.3(3)							
18pF(180)	0.3(3)	0.3(3)	0.3(3)	0.3(3)		0.3(3)						
22pF(220)	0.3(3)	0.3(3)	0.3(3)	0.3(3)		0.3(3)						
27pF(270)	0.3(3)	0.3(3)	0.3(3)	0.3(3)		0.3(3)						
33pF(330)	0.3(3)	0.3(3)	0.3(3)	0.3(3)		0.3(3)						
39pF(390)	0.3(3)	0.3(3)	0.3(3)	0.3(3)		0.3(3)						
47pF(470)	0.3(3)	0.3(3)	0.3(3)	0.3(3)		0.3(3)						
56pF(560)	0.3(3)	0.3(3)	0.3(3)	0.3(3)		0.3(3)						
68pF(680)	0.3(3)	0.3(3)	0.3(3)	0.3(3)		0.3(3)						
82pF(820)	0.3(3)	0.3(3)	0.3(3)	0.3(3)		0.3(3)						
100pF(101)	0.3(3)	0.3(3)	0.3(3)	0.3(3)		0.3(3)				0.3(3)		
150pF(151)										0.3(3)		
220pF(221)										0.3(3)		
330pF(331)										0.3(3)		
470pF(471)										0.3(3)		
680pF(681)										0.3(3)		

Continued on the following page.

Continued from the preceding page.

Part Number	GRM03											
L x W	0.6x0.3 [0201]											
TC	C0G (5C)	R2H (6R)	S2H (6S)	T2H (6T)	U2J (7U)		X5R (R6)		X6S (C8)	X7R (R7)		
Rated Volt.	25 (1E)	25 (1E)	25 (1E)	25 (1E)	50 (1H)	25 (1E)	10 (1A)	6.3 (0J)	4 (0G)	25 (1E)	16 (1C)	10 (1A)
Capacitance (Capacitance part numbering code) and T (mm) Dimension (T Dimension part numbering code)												
1000pF(102)										0.3(3)		
1500pF(152)							0.3(3)			0.3(3)		0.3(3)
2200pF(222)							0.3(3)				0.3(3)	0.3(3)
3300pF(332)							0.3(3)				0.3(3)	0.3(3)
4700pF(472)							0.3(3)					0.3(3)
6800pF(682)							0.3(3)					0.3(3)
10000pF(103)							0.3(3)					0.3(3)
15000pF(153)								0.3*(3)				
22000pF(223)								0.3*(3)				
33000pF(333)								0.3*(3)				
47000pF(473)								0.3*(3)				
68000pF(683)								0.3*(3)				
0.10μF(104)								0.3*(3)	0.3(3)			

The part numbering code is shown in ().

Dimensions are shown in mm and Rated Voltage in Vdc.

*: Please refer to GRM Series Specifications and Test Methods (2) (P.30).

Chip Monolithic Ceramic Capacitors



Tight Tolerance GRM03/15 Series

■ Features

1. Terminations are made of metal highly resistant to migration.
2. A wide selection of sizes is available, from the miniature LxWxT: 0.6x0.3x0.3mm or LxWxT: 1.0x0.5x0.5mm.
3. GRM03 type is a complete line of chip ceramic capacitors in 25V ratings, GRM15 type is a complete line of chip ceramic capacitors in 50V ratings.
4. These capacitors have temperature characteristics ranging COG.
5. GRM03 and GRM15 type are applied to only reflow soldering.
6. Stringent dimensional tolerances allow highly reliable, high speed automatic chip placement on PCBs.
7. GRM series is available in paper tape and reel packaging for automatic placement.

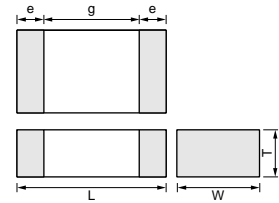

Part Number	Dimensions (mm)				
	L	W	T	e	g min.
GRM033	0.6 ±0.03	0.3 ±0.03	0.3 ±0.03	0.1 to 0.2	0.2
GRM155	1.0 ±0.05	0.5 ±0.05	0.5 ±0.05	0.15 to 0.35	0.3

■ Applications

General electronic equipment

Temperature Compensating Type GRM03/15 Series

Part Number	GRM03	GRM15
L x W [EIA]	0.6x0.3 [0201]	1.0x0.5 [0402]
TC	COG (5C)	COG (5C)
Rated Volt.	25 (1E)	50 (1H)
Capacitance, Capacitance Tolerance and T Dimension		
0.30pF(R30)	W, B 0.3(3)	0.5(5)
0.40pF(R40)	W, B 0.3(3)	0.5(5)
0.50pF(R50)	W, B 0.3(3)	0.5(5)
0.60pF(R60)	W, B 0.3(3)	0.5(5)
0.70pF(R70)	W, B 0.3(3)	0.5(5)
0.80pF(R80)	W, B 0.3(3)	0.5(5)
0.90pF(R90)	W, B 0.3(3)	0.5(5)
1.0pF(1R0)	W, B 0.3(3)	0.5(5)
1.1pF(1R1)	W, B 0.3(3)	0.5(5)
1.2pF(1R2)	W, B 0.3(3)	0.5(5)
1.3pF(1R3)	W, B 0.3(3)	0.5(5)
1.4pF(1R4)	W, B 0.3(3)	0.5(5)
1.5pF(1R5)	W, B 0.3(3)	0.5(5)
1.6pF(1R6)	W, B 0.3(3)	0.5(5)
1.7pF(1R7)	W, B 0.3(3)	0.5(5)
1.8pF(1R8)	W, B 0.3(3)	0.5(5)
1.9pF(1R9)	W, B 0.3(3)	0.5(5)
2.0pF(2R0)	W, B 0.3(3)	0.5(5)
2.1pF(2R1)	W, B 0.3(3)	0.5(5)
2.2pF(2R2)	W, B 0.3(3)	0.5(5)
2.3pF(2R3)	W, B 0.3(3)	0.5(5)

Continued on the following page.

 Continued from the preceding page.

Part Number	GRM03		GRM15	
L x W [EIA]	0.6x0.3 [0201]		1.0x0.5 [0402]	
TC	COG (5C)		COG (5C)	
Rated Volt.	25 (1E)		50 (1H)	
Capacitance, Capacitance Tolerance and T Dimension				
2.4pF(2R4)	W, B	0.3(3)	0.5(5)	
2.5pF(2R5)	W, B	0.3(3)	0.5(5)	
2.6pF(2R6)	W, B	0.3(3)	0.5(5)	
2.7pF(2R7)	W, B	0.3(3)	0.5(5)	
2.8pF(2R8)	W, B	0.3(3)	0.5(5)	
2.9pF(2R9)	W, B	0.3(3)	0.5(5)	
3.0pF(3R0)	W, B	0.3(3)	0.5(5)	
3.1pF(3R1)	W, B	0.3(3)	0.5(5)	
3.2pF(3R2)	W, B	0.3(3)	0.5(5)	
3.3pF(3R3)	W, B	0.3(3)	0.5(5)	
3.4pF(3R4)	W, B	0.3(3)	0.5(5)	
3.5pF(3R5)	W, B	0.3(3)	0.5(5)	
3.6pF(3R6)	W, B	0.3(3)	0.5(5)	
3.7pF(3R7)	W, B	0.3(3)	0.5(5)	
3.8pF(3R8)	W, B	0.3(3)	0.5(5)	
3.9pF(3R9)	W, B	0.3(3)	0.5(5)	
4.0pF(4R0)	W, B	0.3(3)	0.5(5)	
4.1pF(4R1)	W, B	0.3(3)	0.5(5)	
4.2pF(4R2)	W, B	0.3(3)	0.5(5)	
4.3pF(4R3)	W, B	0.3(3)	0.5(5)	
4.4pF(4R4)	W, B	0.3(3)	0.5(5)	
4.5pF(4R5)	W, B	0.3(3)	0.5(5)	
4.6pF(4R6)	W, B	0.3(3)	0.5(5)	
4.7pF(4R7)	W, B	0.3(3)	0.5(5)	
4.8pF(4R8)	W, B	0.3(3)	0.5(5)	
4.9pF(4R9)	W, B	0.3(3)	0.5(5)	
5.0pF(5R0)	W, B	0.3(3)	0.5(5)	
5.1pF(5R1)	W, B, C	0.3(3)	0.5(5)	
5.2pF(5R2)	W, B, C	0.3(3)	0.5(5)	
5.3pF(5R3)	W, B, C	0.3(3)	0.5(5)	
5.4pF(5R4)	W, B, C	0.3(3)	0.5(5)	
5.5pF(5R5)	W, B, C	0.3(3)	0.5(5)	
5.6pF(5R6)	W, B, C	0.3(3)	0.5(5)	
5.7pF(5R7)	W, B, C	0.3(3)	0.5(5)	
5.8pF(5R8)	W, B, C	0.3(3)	0.5(5)	
5.9pF(5R9)	W, B, C	0.3(3)	0.5(5)	
6.0pF(6R0)	W, B, C	0.3(3)	0.5(5)	
6.1pF(6R1)	W, B, C	0.3(3)	0.5(5)	
6.2pF(6R2)	W, B, C	0.3(3)	0.5(5)	
6.3pF(6R3)	W, B, C	0.3(3)	0.5(5)	
6.4pF(6R4)	W, B, C	0.3(3)	0.5(5)	
6.5pF(6R5)	W, B, C	0.3(3)	0.5(5)	
6.6pF(6R6)	W, B, C	0.3(3)	0.5(5)	
6.7pF(6R7)	W, B, C	0.3(3)	0.5(5)	
6.8pF(6R8)	W, B, C	0.3(3)	0.5(5)	
6.9pF(6R9)	W, B, C	0.3(3)	0.5(5)	
7.0pF(7R0)	W, B, C	0.3(3)	0.5(5)	
7.1pF(7R1)	W, B, C	0.3(3)	0.5(5)	
7.2pF(7R2)	W, B, C	0.3(3)	0.5(5)	
7.3pF(7R3)	W, B, C	0.3(3)	0.5(5)	
7.4pF(7R4)	W, B, C	0.3(3)	0.5(5)	
7.5pF(7R5)	W, B, C	0.3(3)	0.5(5)	

Continued on the following page. 

Continued from the preceding page.

Part Number		GRM03	GRM15
L x W [EIA]		0.6x0.3 [0201]	1.0x0.5 [0402]
TC		COG (5C)	COG (5C)
Rated Volt.		25 (1E)	50 (1H)
Capacitance, Capacitance Tolerance and T Dimension			
7.6pF(7R6)	W, B, C	0.3(3)	0.5(5)
7.7pF(7R7)	W, B, C	0.3(3)	0.5(5)
7.8pF(7R8)	W, B, C	0.3(3)	0.5(5)
7.9pF(7R9)	W, B, C	0.3(3)	0.5(5)
8.0pF(8R0)	W, B, C	0.3(3)	0.5(5)
8.1pF(8R1)	W, B, C	0.3(3)	0.5(5)
8.2pF(8R2)	W, B, C	0.3(3)	0.5(5)
8.3pF(8R3)	W, B, C	0.3(3)	0.5(5)
8.4pF(8R4)	W, B, C	0.3(3)	0.5(5)
8.5pF(8R5)	W, B, C	0.3(3)	0.5(5)
8.6pF(8R6)	W, B, C	0.3(3)	0.5(5)
8.7pF(8R7)	W, B, C	0.3(3)	0.5(5)
8.8pF(8R8)	W, B, C	0.3(3)	0.5(5)
8.9pF(8R9)	W, B, C	0.3(3)	0.5(5)
9.0pF(9R0)	W, B, C	0.3(3)	0.5(5)
9.1pF(9R1)	W, B, C	0.3(3)	0.5(5)
9.2pF(9R2)	W, B, C	0.3(3)	0.5(5)
9.3pF(9R3)	W, B, C	0.3(3)	0.5(5)
9.4pF(9R4)	W, B, C	0.3(3)	0.5(5)
9.5pF(9R5)	W, B, C	0.3(3)	0.5(5)
9.6pF(9R6)	W, B, C	0.3(3)	0.5(5)
9.7pF(9R7)	W, B, C	0.3(3)	0.5(5)
9.8pF(9R8)	W, B, C	0.3(3)	0.5(5)
9.9pF(9R9)	W, B, C	0.3(3)	0.5(5)

The part numbering code is shown in ().

Dimensions are shown in mm and Rated Voltage in Vdc.

Chip Monolithic Ceramic Capacitors



Thin Type

■ Features

1. This series is suited to flow and reflow soldering.
Capacitor terminations are made of metal highly resistant to migration.
2. Large capacitance values enable excellent bypass effects to be realized.
3. GRM18, 21 and GRM31 types are suited to flow and reflow soldering.
GRM15 and GRM32 types are applied to only reflow soldering.
4. Its thin package makes this series ideally suited for the production of small electronic products and for mounting underneath ICs.

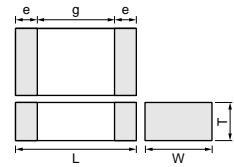

Part Number	Dimensions (mm)				
	L	W	T	e	g min.
GRM15X	1.0 ±0.05	0.5 ±0.05	0.25 ±0.05	0.1 to 0.3	0.4
GRM153			0.3 ±0.03		
GRM216	2.0 ±0.1	1.25 ±0.1	0.6 ±0.1	0.2 to 0.7	0.7
GRM219			0.85 ±0.1		
GRM21A			1.0 +0/-0.2		
GRM316	3.2 ±0.15	1.6 ±0.15	0.6 ±0.1	0.3 to 0.8	1.5
GRM319			0.85 ±0.1		
GRM329	3.2 ±0.3	2.5 ±0.2	0.85 ±0.1	0.3 min.	1.0
GRM32A			1.0 +0/-0.2		

■ Applications

Thin equipment such as IC cards

Temperature Compensating Type

Part Number	TC Code (Standard)	Rated Voltage (Vdc)	Capacitance (pF)	Length L (mm)	Width W (mm)	Thickness T (mm)	EIA
GRM1535C1H1R0CDD5	COG (EIA)	50	1.0 ±0.25pF	1.0	0.5	0.3	0402
GRM1535C1H2R0CDD5	COG (EIA)	50	2.0 ±0.25pF	1.0	0.5	0.3	0402
GRM1535C1H3R0CDD5	COG (EIA)	50	3.0 ±0.25pF	1.0	0.5	0.3	0402
GRM1535C1H4R0CDD5	COG (EIA)	50	4.0 ±0.25pF	1.0	0.5	0.3	0402
GRM1535C1H5R0CDD5	COG (EIA)	50	5.0 ±0.25pF	1.0	0.5	0.3	0402
GRM1535C1H6R0DDD5	COG (EIA)	50	6.0 ±0.5pF	1.0	0.5	0.3	0402
GRM1535C1H7R0DDD5	COG (EIA)	50	7.0 ±0.5pF	1.0	0.5	0.3	0402
GRM1535C1H8R0DDD5	COG (EIA)	50	8.0 ±0.5pF	1.0	0.5	0.3	0402
GRM1535C1H9R0DDD5	COG (EIA)	50	9.0 ±0.5pF	1.0	0.5	0.3	0402
GRM1535C1H100JDD5	COG (EIA)	50	10 ±5%	1.0	0.5	0.3	0402
GRM1535C1H120JDD5	COG (EIA)	50	12 ±5%	1.0	0.5	0.3	0402
GRM1535C1H150JDD5	COG (EIA)	50	15 ±5%	1.0	0.5	0.3	0402
GRM1535C1H180JDD5	COG (EIA)	50	18 ±5%	1.0	0.5	0.3	0402
GRM1535C1H220JDD5	COG (EIA)	50	22 ±5%	1.0	0.5	0.3	0402
GRM1535C1H270JDD5	COG (EIA)	50	27 ±5%	1.0	0.5	0.3	0402
GRM1535C1H330JDD5	COG (EIA)	50	33 ±5%	1.0	0.5	0.3	0402
GRM1535C1H390JDD5	COG (EIA)	50	39 ±5%	1.0	0.5	0.3	0402
GRM1535C1H470JDD5	COG (EIA)	50	47 ±5%	1.0	0.5	0.3	0402
GRM1535C1H560JDD5	COG (EIA)	50	56 ±5%	1.0	0.5	0.3	0402
GRM1535C1H680JDD5	COG (EIA)	50	68 ±5%	1.0	0.5	0.3	0402
GRM1535C1H820JDD5	COG (EIA)	50	82 ±5%	1.0	0.5	0.3	0402
GRM1535C1H101JDD5	COG (EIA)	50	100 ±5%	1.0	0.5	0.3	0402

High Dielectric Constant Type

Part Number	TC Code (Standard)	Rated Voltage (Vdc)	Capacitance	Length L (mm)	Width W (mm)	Thickness T (mm)	EIA
GRM15XR71H221KA86	X7R (EIA)	50	220pF ±10%	1.0	0.5	0.25	0402
GRM15XR71H331KA86	X7R (EIA)	50	330pF ±10%	1.0	0.5	0.25	0402
GRM15XR71H471KA86	X7R (EIA)	50	470pF ±10%	1.0	0.5	0.25	0402
GRM15XR71H681KA86	X7R (EIA)	50	680pF ±10%	1.0	0.5	0.25	0402
GRM15XR71H102KA86	X7R (EIA)	50	1000pF ±10%	1.0	0.5	0.25	0402
GRM15XR71H152KA86	X7R (EIA)	50	1500pF ±10%	1.0	0.5	0.25	0402
GRM15XR71E222KA86	X7R (EIA)	25	2200pF ±10%	1.0	0.5	0.25	0402
GRM219R71E105KA88	X7R (EIA)	25	1.0μF ±10%	2.0	1.25	0.85	0805
GRM15XR71C332KA86	X7R (EIA)	16	3300pF ±10%	1.0	0.5	0.25	0402
GRM15XR71C472KA86	X7R (EIA)	16	4700pF ±10%	1.0	0.5	0.25	0402
GRM15XR71C682KA86	X7R (EIA)	16	6800pF ±10%	1.0	0.5	0.25	0402
GRM15XR71C103KA86	X7R (EIA)	16	10000pF ±10%	1.0	0.5	0.25	0402
GRM216C81C105KA12	X6S(EIA)	16	1.0μF ±10%	2.0	1.25	0.6*	0805
GRM316C81C225KA12	X6S(EIA)	16	2.2μF ±10%	3.2	1.6	0.6*	1206
GRM219C81C225KA12	X6S(EIA)	16	2.2μF ±10%	2.0	1.25	0.85*	0805
GRM319C81C475KA12	X6S(EIA)	16	4.7μF ±10%	3.2	1.6	0.85*	1206
GRM219C81A475KE34	X6S(EIA)	10	4.7μF ±10%	2.0	1.25	0.85*	0805
GRM219C80J475KE19	X6S(EIA)	6.3	4.7μF ±10%	2.0	1.25	0.85*	0805
GRM319C80J106KE19	X6S(EIA)	6.3	10μF ±10%	3.2	1.6	0.85*	1206
GRM219C80G106KE19	X6S(EIA)	4	10μF ±10%	2.0	1.25	0.85*	0805
GRM216R61E105KA12	X5R (EIA)	25	1.0μF ±10%	2.0	1.25	0.6*	0805
GRM316R61E225KA12	X5R (EIA)	25	2.2μF ±10%	3.2	1.6	0.6*	1206
GRM219R61E225KA12	X5R (EIA)	25	2.2μF ±10%	2.0	1.25	0.85*	0805
GRM319R61E475KA12	X5R (EIA)	25	4.7μF ±10%	3.2	1.6	0.85*	1206
GRM216R61C105KA88	X5R (EIA)	16	1.0μF ±10%	2.0	1.25	0.6*	0805
GRM316R61C225KA88	X5R (EIA)	16	2.2μF ±10%	3.2	1.6	0.6*	1206
GRM219R61C225KA88	X5R (EIA)	16	2.2μF ±10%	2.0	1.25	0.85*	0805
GRM219R61C475KE15	X5R (EIA)	16	4.7μF ±10%	2.0	1.25	0.85*	0805
GRM319R61C475KA88	X5R (EIA)	16	4.7μF ±10%	3.2	1.6	0.85*	1206
GRM319R61C106KE15	X5R (EIA)	16	10μF ±10%	3.2	1.6	0.85*	1206
GRM216R61A225KE24	X5R (EIA)	10	2.2μF ±10%	2.0	1.25	0.6*	0805
GRM219R61A225KA01	X5R (EIA)	10	2.2μF ±10%	2.0	1.25	0.85*	0805
GRM316R61A335KE19	X5R (EIA)	10	3.3μF ±10%	3.2	1.6	0.6*	1206
GRM219R61A335KE19	X5R (EIA)	10	3.3μF ±10%	2.0	1.25	0.85*	0805
GRM316R61A475KE19	X5R (EIA)	10	4.7μF ±10%	3.2	1.6	0.6*	1206
GRM219R61A475KE34	X5R (EIA)	10	4.7μF ±10%	2.0	1.25	0.85*	0805
GRM319R61A106KE19	X5R (EIA)	10	10μF ±10%	3.2	1.6	0.85*	1206
GRM219R60J475KE19	X5R (EIA)	6.3	4.7μF ±10%	2.0	1.25	0.85*	0805
GRM319R60J106KE19	X5R (EIA)	6.3	10μF ±10%	3.2	1.6	0.85*	1206

*: Please refer to GRM Series Specifications and Test Methods (2) (P.30).

5

GRM Series Specifications and Test Methods (1)

Below GRM Series Specifications and Test Methods (1) are applied to Non "*" PNs in capacitance table.
 In case "*" is added in capacitance table, please refer to GRM Series Specifications and Test Methods (2) (P.30).

No.	Item	Specifications		Test Method
		Temperature Compensating Type	High Dielectric Type	
1	Operating Temperature Range	-55 to +125°C	B1, B3, F1, R6: -25 to +85°C R1, R7: -55 to +125°C C8: -55 to +105°C E4: +10 to +85°C F5: -30 to +85°C	Reference temperature: 25°C (2Δ, 3Δ, 4Δ, B1, B3, F1, R1: 20°C)
2	Rated Voltage	See the previous pages.		The rated voltage is defined as the maximum voltage which may be applied continuously to the capacitor. When AC voltage is superimposed on DC voltage, V^{P-P} or V^{O-P} , whichever is larger, should be maintained within the rated voltage range.
3	Appearance	No defects or abnormalities		Visual inspection
4	Dimensions	Within the specified dimensions		Using calipers (GRM02 size is based on Microscope)
5	Dielectric Strength	No defects or abnormalities		No failure should be observed when 300%* of the rated voltage (temperature compensating type) or 250% of the rated voltage (high dielectric constant type) is applied between the terminations for 1 to 5 seconds, provided the charge/discharge current is less than 50mA. *200% for 500V
6	Insulation Resistance	$C \leq 0.047\mu\text{F}$: More than 10,000MΩ $C > 0.047\mu\text{F}$: $500\Omega \cdot F$ C: Nominal Capacitance		The insulation resistance should be measured with a DC voltage not exceeding the rated voltage at 20/25°C and 75%RH max. and within 2 minutes of charging, provided the charge/discharge current is less than 50mA.
7	Capacitance	Within the specified tolerance		The capacitance/Q/D.F. should be measured at 20/25°C at the frequency and voltage shown in the table.
8	Q/ Dissipation Factor (D.F.)	30pF and over: $Q \geq 1000$ 30pF and below: $Q \geq 400 + 20C$ C: Nominal Capacitance (pF)	[R6, R7, C8] W.V.: 100V : 0.025 max. ($C < 0.068\mu\text{F}$) : 0.05 max. ($C \geq 0.068\mu\text{F}$) W.V.: 50/25V : 0.025 max. ($C < 10\mu\text{F}$) : 0.035 max. ($C \geq 10\mu\text{F}$) W.V.: 16/10V: 0.035 max. W.V.: 6.3/4V : 0.05 max. ($C < 3.3\mu\text{F}$) : 0.1 max. ($C \geq 3.3\mu\text{F}$) [E4] W.V.: 25Vmin: 0.025 max. [F1, F5] W.V.: 25V min. : 0.05 max. ($C < 0.1\mu\text{F}$) : 0.09 max. ($C \geq 0.1\mu\text{F}$) W.V.: 16/10V: 0.125 max. W.V.: 6.3V: 0.15 max.	

Char.	ΔC to 7U, 1X (1000pF and below)	ΔC to 7U, 1X (more than 1000pF)	R6, R7, F5 ($C > 10\mu\text{F}$)	E4
Item				
Frequency	1±0.1MHz	1±0.1kHz	120±24kHz	1±0.1kHz
Voltage	0.5 to 5Vrms	1±0.2Vrms	0.5±0.1Vrms	0.5±0.05Vrms

Continued on the following page. 

GRM Series Specifications and Test Methods (1)

Below GRM Series Specifications and Test Methods (1) are applied to Non "*" PNs in capacitance table.

Continued from the preceding page. **In case "*" is added in capacitance table, please refer to GRM Series Specifications and Test Methods (2) (P.30).**

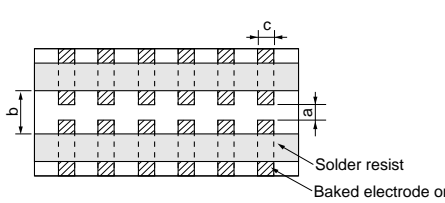
No.	Item	Specifications		Test Method																																						
		Temperature Compensating Type	High Dielectric Type																																							
9	Capacitance Temperature Characteristics	No bias	Within the specified tolerance (Table A-1)	B1, B3: Within $\pm 10\%$ (−25 to +85°C) R1, R7: Within $\pm 15\%$ (−55 to +125°C) R6: Within $\pm 15\%$ (−55 to +85°C) E4: Within +22/−56% (+10 to +85°C) F1: Within +30/−80% (−25 to +85°C) F5: Within +22/−82% (−30 to +85°C) C8: Within $\pm 22\%$ (−55 to +105°C)	The capacitance change should be measured after 5 min. at each specified temp. stage. (1) Temperature Compensating Type The temperature coefficient is determined using the capacitance measured in step 3 as a reference. When cycling the temperature sequentially from step 1 through 5 (5C: +25 to +125°C/ΔC: +20 to +125°C: other temp. coeffs.: +25 to +85°C/+20 to +85°C) the capacitance should be within the specified tolerance for the temperature coefficient and capacitance change as Table A-1. The capacitance drift is calculated by dividing the differences between the maximum and minimum measured values in the step 1, 3 and 5 by the cap. value in step 3.																																					
		50% of the Rated Voltage	/	B1: Within +10/−30% R1: Within +15/−40% F1: Within +30/−95%																																						
		Capacitance Drift	Within $\pm 0.2\%$ or $\pm 0.05\text{pF}$ (Whichever is larger.) *Do not apply to 1X/25V	*Initial measurement for high dielectric constant type Perform a heat treatment at 150+0/−10°C for one hour and then set for 24±2 hours at room temperature. Perform the initial measurement.		(2) High Dielectric Constant Type The ranges of capacitance change compared with the 20°C value over the temperature ranges shown in the table should be within the specified ranges.* In case of applying voltage, the capacitance change should be measured after 1 more min. with applying voltage in equilibration of each temp. stage.																																				
10	Adhesive Strength of Termination	No removal of the terminations or other defect should occur.		Solder the capacitor to the test jig (glass epoxy board) shown in Fig. 1a using an eutectic solder. Then apply 10N* force in parallel with the test jig for 10±1 sec. The soldering should be done either with an iron or using the reflow method and should be conducted with care so that the soldering is uniform and free of defects such as heat shock. *1N (GRM02), 2N (GRM03), 5N (GRM15, GRM18)																																						
		 <p style="text-align: center;">Fig. 1a</p>			<table border="1" style="margin-left: auto; margin-right: auto;"> <thead> <tr> <th>Type</th> <th>a</th> <th>b</th> <th>c</th> </tr> </thead> <tbody> <tr> <td>GRM02</td> <td>0.2</td> <td>0.56</td> <td>0.23</td> </tr> <tr> <td>GRM03</td> <td>0.3</td> <td>0.9</td> <td>0.3</td> </tr> <tr> <td>GRM15</td> <td>0.4</td> <td>1.5</td> <td>0.5</td> </tr> <tr> <td>GRM18</td> <td>1.0</td> <td>3.0</td> <td>1.2</td> </tr> <tr> <td>GRM21</td> <td>1.2</td> <td>4.0</td> <td>1.65</td> </tr> <tr> <td>GRM31</td> <td>2.2</td> <td>5.0</td> <td>2.0</td> </tr> <tr> <td>GRM32</td> <td>2.2</td> <td>5.0</td> <td>2.9</td> </tr> <tr> <td>GRM43</td> <td>3.5</td> <td>7.0</td> <td>3.7</td> </tr> <tr> <td>GRM55</td> <td>4.5</td> <td>8.0</td> <td>5.6</td> </tr> </tbody> </table> <p style="text-align: right;">(in mm)</p>	Type	a	b	c	GRM02	0.2	0.56	0.23	GRM03	0.3	0.9	0.3	GRM15	0.4	1.5	0.5	GRM18	1.0	3.0	1.2	GRM21	1.2	4.0	1.65	GRM31	2.2	5.0	2.0	GRM32	2.2	5.0	2.9	GRM43	3.5	7.0	3.7	GRM55
Type	a	b	c																																							
GRM02	0.2	0.56	0.23																																							
GRM03	0.3	0.9	0.3																																							
GRM15	0.4	1.5	0.5																																							
GRM18	1.0	3.0	1.2																																							
GRM21	1.2	4.0	1.65																																							
GRM31	2.2	5.0	2.0																																							
GRM32	2.2	5.0	2.9																																							
GRM43	3.5	7.0	3.7																																							
GRM55	4.5	8.0	5.6																																							

Continued on the following page.

GRM Series Specifications and Test Methods (1)

Below GRM Series Specifications and Test Methods (1) are applied to Non "*" PNs in capacitance table.

Continued from the preceding page. In case "*" is added in capacitance table, please refer to GRM Series Specifications and Test Methods (2) (P.30).

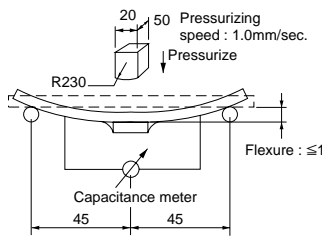
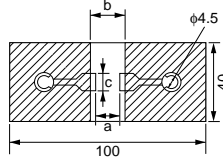
No.	Item	Specifications		Test Method																																								
		Temperature Compensating Type	High Dielectric Type																																									
11	Appearance	No defects or abnormalities		Solder the capacitor on the test jig (glass epoxy board) in the same manner and under the same conditions as (10). The capacitor should be subjected to a simple harmonic motion having a total amplitude of 1.5mm, the frequency being varied uniformly between the approximate limits of 10 and 55Hz. The frequency range, from 10 to 55Hz and return to 10Hz, should be traversed in approximately 1 minute. This motion should be applied for a period of 2 hours in each of 3 mutually perpendicular directions (total of 6 hours).																																								
	Capacitance	Within the specified tolerance																																										
11	Vibration Resistance	Q/D.F.	30pF and over: $Q \geq 1000$ 30pF and below: $Q \geq 400 + 20C$ C: Nominal Capacitance (pF)	[B1, B3, R6, R7, C8] W.V.: 100V : 0.025 max. ($C < 0.068\mu\text{F}$) : 0.05 max. ($C \geq 0.068\mu\text{F}$) W.V.: 50/25V : 0.025 max. ($C < 10\mu\text{F}$) : 0.035 max. ($C \geq 10\mu\text{F}$) W.V.: 16/10V: 0.035 max. W.V.: 6.3/4V : 0.05 max. ($C < 3.3\mu\text{F}$) : 0.1 max. ($C \geq 3.3\mu\text{F}$) [E4] W.V.: 25Vmin: 0.025 max. [F1, F5] W.V.: 25V min. : 0.05 max. ($C < 0.1\mu\text{F}$) : 0.09 max. ($C \geq 0.1\mu\text{F}$) W.V.: 16/10V: 0.125 max. W.V.: 6.3V: 0.15 max.																																								
			12	Deflection	No crack or marked defect should occur.	Solder the capacitor on the test jig (glass epoxy board) shown in Fig. 2a using an eutectic solder. Then apply a force in the direction shown in Fig. 3a for 5 ± 1 sec. The soldering should be done by the reflow method and should be conducted with care so that the soldering is uniform and free of defects such as heat shock.																																						
			 <p>Fig. 3a</p>	 <p>Fig. 2a t: 1.6mm (GRM02/03/15: t: 0.8mm)</p> <table border="1"> <thead> <tr> <th>Type</th> <th>a</th> <th>b</th> <th>c</th> </tr> </thead> <tbody> <tr> <td>GRM02</td> <td>0.2</td> <td>0.56</td> <td>0.23</td> </tr> <tr> <td>GRM03</td> <td>0.3</td> <td>0.9</td> <td>0.3</td> </tr> <tr> <td>GRM15</td> <td>0.4</td> <td>1.5</td> <td>0.5</td> </tr> <tr> <td>GRM18</td> <td>1.0</td> <td>3.0</td> <td>1.2</td> </tr> <tr> <td>GRM21</td> <td>1.2</td> <td>4.0</td> <td>1.65</td> </tr> <tr> <td>GRM31</td> <td>2.2</td> <td>5.0</td> <td>2.0</td> </tr> <tr> <td>GRM32</td> <td>2.2</td> <td>5.0</td> <td>2.9</td> </tr> <tr> <td>GRM43</td> <td>3.5</td> <td>7.0</td> <td>3.7</td> </tr> <tr> <td>GRM55</td> <td>4.5</td> <td>8.0</td> <td>5.6</td> </tr> </tbody> </table> <p>(in mm)</p>	Type	a	b	c	GRM02	0.2	0.56	0.23	GRM03	0.3	0.9	0.3	GRM15	0.4	1.5	0.5	GRM18	1.0	3.0	1.2	GRM21	1.2	4.0	1.65	GRM31	2.2	5.0	2.0	GRM32	2.2	5.0	2.9	GRM43	3.5	7.0	3.7	GRM55	4.5	8.0	5.6
Type	a	b	c																																									
GRM02	0.2	0.56	0.23																																									
GRM03	0.3	0.9	0.3																																									
GRM15	0.4	1.5	0.5																																									
GRM18	1.0	3.0	1.2																																									
GRM21	1.2	4.0	1.65																																									
GRM31	2.2	5.0	2.0																																									
GRM32	2.2	5.0	2.9																																									
GRM43	3.5	7.0	3.7																																									
GRM55	4.5	8.0	5.6																																									
13	Solderability of Termination	75% of the terminations are to be soldered evenly and continuously.		Immerse the capacitor in a solution of ethanol (JIS-K-8101) and rosin (JIS-K-5902) (25% rosin in weight proportion) . Preheat at 80 to 120°C for 10 to 30 seconds. After preheating, immerse in an eutectic solder solution for 2 ± 0.5 seconds at $230 \pm 5^\circ\text{C}$ or Sn-3.0Ag-0.5Cu solder solution for 2 ± 0.5 seconds at $245 \pm 5^\circ\text{C}$.																																								

Continued on the following page. 

GRM Series Specifications and Test Methods (1)

Below GRM Series Specifications and Test Methods (1) are applied to Non "*" PNs in capacitance table.

Continued from the preceding page. **In case "*" is added in capacitance table, please refer to GRM Series Specifications and Test Methods (2) (P.30).**

No.	Item	Specifications		Test Method	
		Temperature Compensating Type	High Dielectric Type		
14	Resistance to Soldering Heat	The measured and observed characteristics should satisfy the specifications in the following table.		Preheat the capacitor at 120 to 150°C for 1 minute. Immerse the capacitor in an eutectic solder or Sn-3.0Ag-0.5Cu solder solution at 270±5°C for 10±0.5 seconds. Set at room temperature for 24±2 hours, then measure. •Initial measurement for high dielectric constant type Perform a heat treatment at 150+0/-10°C for one hour and then set at room temperature for 24±2 hours. Perform the initial measurement. •Preheating for GRM32/43/55	
		Appearance	No defects or abnormalities		
		Capacitance Change	Within ±2.5% or ±0.25pF (Whichever is larger)		B1, B3, R1, R6, R7, C8 : Within ±7.5% F1, F5, E4: Within ±20%
		Q/D.F.	30pF and over: Q≥1000 30pF and below: Q≥400+20C C: Nominal Capacitance (pF)		[B1, B3, R6, R7, C8] W.V.: 100V : 0.025 max. (C<0.068μF) : 0.05 max. (C≥0.068μF) W.V.: 50/25V : 0.025 max. (C<10μF) : 0.035 max. (C≥10μF) W.V.: 16/10V: 0.035 max. W.V.: 6.3/4V : 0.05 max. (C<3.3μF) : 0.1 max. (C≥3.3μF) [E4] W.V.: 25Vmin: 0.025 max. [F1, F5] W.V.: 25V min. : 0.05 max. (C<0.1μF) : 0.09 max. (C≥0.1μF) W.V.: 16/10V: 0.125 max. W.V.: 6.3V: 0.15 max.
		I.R.	More than 10,000MΩ or 500Ω · F (Whichever is smaller)		
		Dielectric Strength	No defects		
15	Temperature Cycle	The measured and observed characteristics should satisfy the specifications in the following table.		Fix the capacitor to the supporting jig in the same manner and under the same conditions as (10). Perform the five cycles according to the four heat treatments shown in the following table. Set for 24±2 hours at room temperature, then measure.	
		Appearance	No defects or abnormalities		
		Capacitance Change	Within ±2.5% or ±0.25pF (Whichever is larger)		B1, B3, R1, R6, R7, C8 : Within ±7.5% F1, F5, E4: Within ±20%
		Q/D.F.	30pF and over: Q≥1000 30pF and below: Q≥400+20C C: Nominal Capacitance (pF)		[R6, R7, C8] W.V.: 100V : 0.05 max. (C<0.068μF) : 0.075 max. (C≥0.068μF) W.V.: 50/25/16/10V : 0.05 max. W.V.: 6.3/4V : 0.075 max. (C<3.3μF) : 0.125 max. (C≥3.3μF) [E4] W.V.: 25Vmin: 0.05 max. [F1, F5] W.V.: 25V min. : 0.05 max. (C<0.1μF) : 0.09 max. (C≥0.1μF) W.V.: 16/10V: 0.125 max. W.V.: 6.3V: 0.15 max.
		I.R.	More than 10,000MΩ or 500Ω · F (Whichever is smaller)		
		Dielectric Strength	No defects		

Step	Temperature	Time
1	100 to 120°C	1 min.
2	170 to 200°C	1 min.

Step	1	2	3	4
Temp. (°C)	Min. Operating Temp. +0/-3	Room Temp.	Max. Operating Temp. +3/-0	Room Temp.
Time (min.)	30±3	2 to 3	30±3	2 to 3

Continued on the following page.

GRM Series Specifications and Test Methods (1)

Below GRM Series Specifications and Test Methods (1) are applied to Non "*" PNs in capacitance table.

Continued from the preceding page. In case "*" is added in capacitance table, please refer to GRM Series Specifications and Test Methods (2) (P.30).

No.	Item	Specifications		Test Method	
		Temperature Compensating Type	High Dielectric Type		
16	Humidity (Steady State)	The measured and observed characteristics should satisfy the specifications in the following table.		Set the capacitor at 40±2°C and in 90 to 95% humidity for 500±12 hours. Remove and set for 24±2 hours at room temperature, then measure.	
		Appearance	No defects or abnormalities		
		Capacitance Change	Within ±5% or ±0.5pF (Whichever is larger)		B1, B3, R1, R6, R7, C8 : Within ±12.5% F1, F5, E4: Within ±30%
		Q/D.F.	30pF and over: Q≥350 10pF and over 30pF and below: Q≥275+2.5C 10pF and below: Q≥200+10C C: Nominal Capacitance (pF)		[R6, R7, C8] W.V.: 100V : 0.05 max. (C<0.068μF) : 0.075 max. (C≥0.068μF) W.V.: 50/25/16/10V : 0.05 max. W.V.: 6.3/4V : 0.075 max. (C<3.3μF) : 0.125 max. (C≥3.3μF) [E4] W.V.: 25Vmin: 0.05 max. [F1, F5] W.V.: 25V min. : 0.075 max. (C<0.1μF) : 0.125 max. (C≥0.1μF) W.V.: 16/10V: 0.15 max. W.V.: 6.3V: 0.2 max.
		I.R.	More than 1,000MΩ or 50Ω · F (Whichever is smaller)		
17	Humidity Load	The measured and observed characteristics should satisfy the specifications in the following table.		Apply the rated voltage at 40±2°C and 90 to 95% humidity for 500±12 hours. Remove and set for 24±2 hours at room temperature, then measure. The charge/discharge current is less than 50mA. •Initial measurement for F1, F5/10V max. Apply the rated DC voltage for 1 hour at 40±2°C. Remove and set for 24±2 hours at room temperature. Perform initial measurement.	
		Appearance	No defects or abnormalities		
		Capacitance Change	Within ±7.5% or ±0.75pF (Whichever is larger)		B1, B3, R1, R6, R7, C8 : Within ±12.5% F1, F5, E4: Within ±30% [W.V.: 10V max.] F1, F5: Within +30/-40%
		Q/D.F.	30pF and over: Q≥200 30pF and below: Q≥100+10C/3 C: Nominal Capacitance (pF)		[B1, B3, R6, R7, C8] W.V.: 100V : 0.05 max. (C<0.068μF) : 0.075 max. (C≥0.068μF) W.V.: 50/25/16/10V : 0.05 max. W.V.: 6.3/4V : 0.075 max. (C<3.3μF) : 0.125 max. (C≥3.3μF) [E4] W.V.: 25Vmin: 0.05 max. [F1, F5] W.V.: 25V min. : 0.075 max. (C<0.1μF) : 0.125 max. (C≥0.1μF) W.V.: 16/10V: 0.15 max. W.V.: 6.3V: 0.2 max.
		I.R.	More than 500MΩ or 25Ω · F (Whichever is smaller)		

Continued on the following page. ↗

GRM Series Specifications and Test Methods (1)

Below GRM Series Specifications and Test Methods (1) are applied to Non "*" PNs in capacitance table.

Continued from the preceding page. **In case "*" is added in capacitance table, please refer to GRM Series Specifications and Test Methods (2) (P.30).**

No.	Item	Specifications		Test Method	
		Temperature Compensating Type	High Dielectric Type		
18	High Temperature Load	The measured and observed characteristics should satisfy the specifications in the following table.			Apply 200%* of the rated voltage at the maximum operating temperature ±3°C for 1000±12 hours. Set for 24±2 hours at room temperature, then measure. The charge/discharge current is less than 50mA. •Initial measurement for high dielectric constant type. Apply 200% of the rated DC voltage at the maximum operating temperature ±3°C for one hour. Remove and set for 24±2 hours at room temperature. Perform initial measurement. *150% for 500V
		Appearance	No defects or abnormalities		
		Capacitance Change	Within ±3% or ±0.3pF (Whichever is larger)	B1, B3, R1, R6, R7, C8 : Within ±12.5% F1, F5, E4: Within ±30% [Except 10V max. and C≥1.0μF] F1, F5: Within +30/-40% [10V max. and C≥1.0μF]	
		Q/D.F.	30pF and over: Q≥350 10pF and over 30pF and below: Q≥275+2.5C 10pF and below: Q≥200+10C C: Nominal Capacitance (pF)	[B1, B3, R6, R7, C8] W.V.: 100V : 0.05 max. (C<0.068μF) : 0.075 max. (C≥0.068μF) W.V.: 50/25/16/10V : 0.05 max. W.V.: 6.3/4V : 0.075 max. (C<3.3μF) : 0.125 max. (C≥3.3μF) [E4] W.V.: 25Vmin: 0.05 max. [F1, F5] W.V.: 25V min. : 0.075 max.(C<0.1μF) : 0.125 max.(C≥0.1μF) W.V.: 16/10V: 0.15 max. W.V.: 6.3V: 0.2 max.	
I.R.	More than 1,000MΩ or 50Ω · F (Whichever is smaller)				

Table A-1
(1)

Char.	Nominal Values (ppm/°C)*1	Capacitance Change from 25°C (%)					
		-55		-30		-10	
		Max.	Min.	Max.	Min.	Max.	Min.
5C	0± 30	0.58	-0.24	0.40	-0.17	0.25	-0.11
6C	0± 60	0.87	-0.48	0.59	-0.33	0.38	-0.21
6P	-150± 60	2.33	0.72	1.61	0.50	1.02	0.32
6R	-220± 60	3.02	1.28	2.08	0.88	1.32	0.56
6S	-330± 60	4.09	2.16	2.81	1.49	1.79	0.95
6T	-470± 60	5.46	3.28	3.75	2.26	2.39	1.44
7U	-750±120	8.78	5.04	6.04	3.47	3.84	2.21
1X	+350 to -1000	-	-	-	-	-	-

*1: Nominal values denote the temperature coefficient within a range of 25°C to 125°C (for ΔC)/85°C (for other TC).

(2)

Char.	Nominal Values (ppm/°C)*2	Capacitance Change from 20°C (%)					
		-55		-25		-10	
		Max.	Min.	Max.	Min.	Max.	Min.
2C	0± 60	0.82	-0.45	0.49	-0.27	0.33	-0.18
3C	0±120	1.37	-0.90	0.82	-0.54	0.55	-0.36
4C	0±250	2.56	-1.88	1.54	-1.13	1.02	-0.75
2P	-150± 60	-	-	1.32	0.41	0.88	0.27
3P	-150±120	-	-	1.65	0.14	1.10	0.09
4P	-150±250	-	-	2.36	-0.45	1.57	-0.30
2R	-220± 60	-	-	1.70	0.72	1.13	0.48
3R	-220±120	-	-	2.03	0.45	1.35	0.30
4R	-220±250	-	-	2.74	-0.14	1.83	-0.09
2S	-330± 60	-	-	2.30	1.22	1.54	0.81
3S	-330±120	-	-	2.63	0.95	1.76	0.63
4S	-330±250	-	-	3.35	0.36	2.23	0.24
2T	-470± 60	-	-	3.07	1.85	2.05	1.23
3T	-470±120	-	-	3.40	1.58	2.27	1.05
4T	-470±250	-	-	4.12	0.99	2.74	0.66
3U	-750±120	-	-	4.94	2.84	3.29	1.89
4U	-750±250	-	-	5.65	2.25	3.77	1.50

*2: Nominal values denote the temperature coefficient within a range of 20°C to 125°C (for ΔC)/85°C (for other TC).

GRM Series Specifications and Test Methods (2)

Below GRM Series Specifications and Test Methods (2) are applied to "*" PNs in capacitance table.
 In case "*" is not added in capacitance table, please refer to GRM Series Specifications and Test Methods (1) (P.24).

No.	Item	Specifications	Test Method																		
1	Operating Temperature Range	B1, B3, F1: -25 to +85°C R6: -55 to +85°C R7, C7: -55 to +125°C F5: -30 to +85°C C8: -55 to +105°C,	Reference temperature: 25°C (B1, B3, F1: 20°C)																		
2	Rated Voltage	See the previous pages.	The rated voltage is defined as the maximum voltage which may be applied continuously to the capacitor. When AC voltage is superimposed on DC voltage, V^{P-P} or V^{O-P} , whichever is larger, should be maintained within the rated voltage range.																		
3	Appearance	No defects or abnormalities	Visual inspection																		
4	Dimensions	Within the specified dimensions	Using calipers																		
5	Dielectric Strength	No defects or abnormalities	No failure should be observed when 250% of the rated voltage is applied between the terminations for 1 to 5 seconds, provided the charge/discharge current is less than 50mA.																		
6	Insulation Resistance	More than $50\Omega \cdot F$	The insulation resistance should be measured with a DC voltage not exceeding the rated voltage at reference temperature and 75%RH max. and within 1 minutes of charging, provided the charge/discharge current is less than 50mA.																		
7	Capacitance	Within the specified tolerance	The capacitance/D.F. should be measured at reference temperature at the frequency and voltage shown in the table.																		
8	Dissipation Factor (D.F.)	B1, B3, R6*2, R7, C7, C8: 0.1 max. F1, F5: 0.2 max.	<table border="1"> <thead> <tr> <th>Capacitance</th> <th>Frequency</th> <th>Voltage</th> </tr> </thead> <tbody> <tr> <td>$C \leq 10\mu F$ (10V min.)*1</td> <td>$1 \pm 0.1\text{kHz}$</td> <td>$1.0 \pm 0.2V_{rms}$</td> </tr> <tr> <td>$C \leq 10\mu F$ (6.3V max.)</td> <td>$1 \pm 0.1\text{kHz}$</td> <td>$0.5 \pm 0.1V_{rms}$</td> </tr> <tr> <td>$C > 10\mu F$</td> <td>$120 \pm 24\text{Hz}$</td> <td>$0.5 \pm 0.1V_{rms}$</td> </tr> </tbody> </table> <p>*1 However the voltage is $0.5 \pm 0.1V_{rms}$ about Table 1 items on the left side.</p>	Capacitance	Frequency	Voltage	$C \leq 10\mu F$ (10V min.)*1	$1 \pm 0.1\text{kHz}$	$1.0 \pm 0.2V_{rms}$	$C \leq 10\mu F$ (6.3V max.)	$1 \pm 0.1\text{kHz}$	$0.5 \pm 0.1V_{rms}$	$C > 10\mu F$	$120 \pm 24\text{Hz}$	$0.5 \pm 0.1V_{rms}$						
			Capacitance	Frequency	Voltage																
$C \leq 10\mu F$ (10V min.)*1	$1 \pm 0.1\text{kHz}$	$1.0 \pm 0.2V_{rms}$																			
$C \leq 10\mu F$ (6.3V max.)	$1 \pm 0.1\text{kHz}$	$0.5 \pm 0.1V_{rms}$																			
$C > 10\mu F$	$120 \pm 24\text{Hz}$	$0.5 \pm 0.1V_{rms}$																			
<p>The capacitance change should be measured after 5 min. at each specified temp. stage. The ranges of capacitance change compared with the reference temperature value over the temperature ranges shown in the table should be within the specified ranges.* In case of applying voltage, the capacitance change should be measured after 1 more min. with applying voltage in equilibration of each temp. stage.</p> <p>*GRM43 B1/R6 0J/1A 336/476 only: $1.0 \pm 0.2V_{rms}$</p> <table border="1"> <thead> <tr> <th>Step</th> <th>Temperature (°C)</th> <th>Applying Voltage (V)</th> </tr> </thead> <tbody> <tr> <td>1</td> <td>Reference temperature ± 2</td> <td rowspan="3">No bias</td> </tr> <tr> <td>2</td> <td>-55± 3 (for R6, C7, C8)/ -25± 3 (for B1, B3, F1) -30± 3 (for F5)</td> </tr> <tr> <td>3</td> <td>Reference temperature ± 2</td> </tr> <tr> <td>4</td> <td>85± 3 (for B1, B3, F1, R6, F5) 125± 3 (for C7)/ 105± 3 (for C8)</td> <td rowspan="5">50% of the rated voltage</td> </tr> <tr> <td>5</td> <td>20± 2</td> </tr> <tr> <td>6</td> <td>-25± 3 (for B1, F1)</td> </tr> <tr> <td>7</td> <td>20± 2</td> </tr> <tr> <td>8</td> <td>85± 3 (for B1, F1)</td> </tr> </tbody> </table> <p>• Initial measurement for high dielectric constant type Perform a heat treatment at 150 $\pm 0/-10^\circ\text{C}$ for one hour and then set for 24± 2 hours at room temperature. Perform the initial measurement.</p>	Step	Temperature (°C)	Applying Voltage (V)	1	Reference temperature ± 2	No bias	2	-55 ± 3 (for R6, C7, C8)/ -25 ± 3 (for B1, B3, F1) -30 ± 3 (for F5)	3	Reference temperature ± 2	4	85 ± 3 (for B1, B3, F1, R6, F5) 125 ± 3 (for C7)/ 105 ± 3 (for C8)	50% of the rated voltage	5	20 ± 2	6	-25 ± 3 (for B1, F1)	7	20 ± 2	8	85 ± 3 (for B1, F1)
Step	Temperature (°C)	Applying Voltage (V)																			
1	Reference temperature ± 2	No bias																			
2	-55 ± 3 (for R6, C7, C8)/ -25 ± 3 (for B1, B3, F1) -30 ± 3 (for F5)																				
3	Reference temperature ± 2																				
4	85 ± 3 (for B1, B3, F1, R6, F5) 125 ± 3 (for C7)/ 105 ± 3 (for C8)	50% of the rated voltage																			
5	20 ± 2																				
6	-25 ± 3 (for B1, F1)																				
7	20 ± 2																				
8	85 ± 3 (for B1, F1)																				
9	Capacitance Temperature Characteristics	No bias	<p>B1, B3: Within $\pm 10\%$ (-25 to +85°C) F1 : Within +30/-80% (-25 to +85°C) R6 : Within $\pm 15\%$ (-55 to +85°C) R7 : Within $\pm 15\%$ (-55 to +125°C) F5 : Within +22/-82% (-30 to +85°C) C7 : Within $\pm 22\%$ (-55 to +125°C) C8 : Within $\pm 22\%$ (-55 to +105°C)</p>																		
		50% of the Rated Voltage		<p>B1: Within +10/-30% F1: Within +30/-95%</p>																	

*2: GRM31CR60J107: 0.15 max.

Continued on the following page. 

GRM Series Specifications and Test Methods (2)

Below GRM Series Specifications and Test Methods (2) are applied to "*" PN in capacitance table.

Continued from the preceding page. In case "*" is not added in capacitance table, please refer to GRM Series Specifications and Test Methods (1) (P.24).

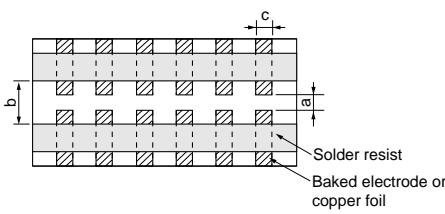
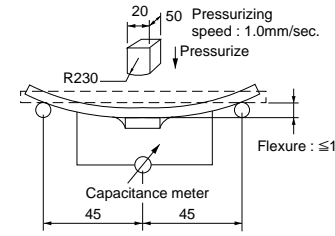
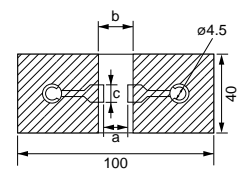
No.	Item	Specifications	Test Method																																								
10	Adhesive Strength of Termination	No removal of the terminations or other defects should occur.	Solder the capacitor on the test jig (glass epoxy board) shown in Fig. 1a using an eutectic solder. Then apply 10N* force in parallel with the test jig for 10±1sec. The soldering should be done either with an iron or using the reflow method and should be conducted with care so that the soldering is uniform and free of defects such as heat shock. *5N: GRM15/GRM18, 2N: GRM03 <table border="1" style="margin-top: 10px; width: 100%; border-collapse: collapse;"> <thead> <tr> <th>Type</th> <th>a</th> <th>b</th> <th>c</th> </tr> </thead> <tbody> <tr><td>GRM02</td><td>0.2</td><td>0.56</td><td>0.23</td></tr> <tr><td>GRM03</td><td>0.3</td><td>0.9</td><td>0.3</td></tr> <tr><td>GRM15</td><td>0.4</td><td>1.5</td><td>0.5</td></tr> <tr><td>GRM18</td><td>1.0</td><td>3.0</td><td>1.2</td></tr> <tr><td>GRM21</td><td>1.2</td><td>4.0</td><td>1.65</td></tr> <tr><td>GRM31</td><td>2.2</td><td>5.0</td><td>2.0</td></tr> <tr><td>GRM32</td><td>2.2</td><td>5.0</td><td>2.9</td></tr> <tr><td>GRM43</td><td>3.5</td><td>7.0</td><td>3.7</td></tr> <tr><td>GRM55</td><td>4.5</td><td>8.0</td><td>5.6</td></tr> </tbody> </table>	Type	a	b	c	GRM02	0.2	0.56	0.23	GRM03	0.3	0.9	0.3	GRM15	0.4	1.5	0.5	GRM18	1.0	3.0	1.2	GRM21	1.2	4.0	1.65	GRM31	2.2	5.0	2.0	GRM32	2.2	5.0	2.9	GRM43	3.5	7.0	3.7	GRM55	4.5	8.0	5.6
		Type		a	b	c																																					
GRM02	0.2	0.56	0.23																																								
GRM03	0.3	0.9	0.3																																								
GRM15	0.4	1.5	0.5																																								
GRM18	1.0	3.0	1.2																																								
GRM21	1.2	4.0	1.65																																								
GRM31	2.2	5.0	2.0																																								
GRM32	2.2	5.0	2.9																																								
GRM43	3.5	7.0	3.7																																								
GRM55	4.5	8.0	5.6																																								
 <p style="text-align: center;">Fig. 1a</p>																																											
11	Vibration	Appearance	No defects or abnormalities																																								
		Capacitance	Within the specified tolerance																																								
		D.F.	B1, B3, R6*2, R7, C7, C8: 0.1 max. F1, F5: 0.2 max.																																								
12	Deflection	No cracking or marking defects should occur.	Solder the capacitor on the test jig (glass epoxy board) shown in Fig. 2a using an eutectic solder. Then apply a force in the direction shown in Fig. 3a for 5±1 sec. The soldering should be done by the reflow method and should be conducted with care so that the soldering is uniform and free of defects such as heat shock. <div style="display: flex; justify-content: space-around; align-items: flex-start;"> <div style="text-align: center;">  <p style="text-align: center;">Fig.3a</p> </div> <div style="text-align: center;">  <p style="text-align: center;">Fig. 2a</p> <p style="text-align: right; font-size: small;">t: 1.6mm (GRM03/15: t: 0.8mm)</p> </div> </div> <table border="1" style="margin-top: 10px; width: 100%; border-collapse: collapse;"> <thead> <tr> <th>Type</th> <th>a</th> <th>b</th> <th>c</th> </tr> </thead> <tbody> <tr><td>GRM02</td><td>0.2</td><td>0.56</td><td>0.23</td></tr> <tr><td>GRM03</td><td>0.3</td><td>0.9</td><td>0.3</td></tr> <tr><td>GRM15</td><td>0.4</td><td>1.5</td><td>0.5</td></tr> <tr><td>GRM18</td><td>1.0</td><td>3.0</td><td>1.2</td></tr> <tr><td>GRM21</td><td>1.2</td><td>4.0</td><td>1.65</td></tr> <tr><td>GRM31</td><td>2.2</td><td>5.0</td><td>2.0</td></tr> <tr><td>GRM32</td><td>2.2</td><td>5.0</td><td>2.9</td></tr> <tr><td>GRM43</td><td>3.5</td><td>7.0</td><td>3.7</td></tr> <tr><td>GRM55</td><td>4.5</td><td>8.0</td><td>5.6</td></tr> </tbody> </table> <p style="text-align: right; font-size: small;">(in mm)</p>	Type	a	b	c	GRM02	0.2	0.56	0.23	GRM03	0.3	0.9	0.3	GRM15	0.4	1.5	0.5	GRM18	1.0	3.0	1.2	GRM21	1.2	4.0	1.65	GRM31	2.2	5.0	2.0	GRM32	2.2	5.0	2.9	GRM43	3.5	7.0	3.7	GRM55	4.5	8.0	5.6
		Type		a	b	c																																					
GRM02	0.2	0.56	0.23																																								
GRM03	0.3	0.9	0.3																																								
GRM15	0.4	1.5	0.5																																								
GRM18	1.0	3.0	1.2																																								
GRM21	1.2	4.0	1.65																																								
GRM31	2.2	5.0	2.0																																								
GRM32	2.2	5.0	2.9																																								
GRM43	3.5	7.0	3.7																																								
GRM55	4.5	8.0	5.6																																								
Solderability of Termination	75% of the terminations is to be soldered evenly and continuously.	Immerse the capacitor in a solution of ethanol (JIS-K-8101) and rosin (JIS-K-5902) (25% rosin in weight proportion) . Preheat at 80 to 120°C for 10 to 30 seconds. After preheating, immerse in an eutectic solder solution for 2±0.5 seconds at 230±5°C or Sn-3.0Ag-0.5Cu solder solution for 2±0.5 seconds at 245±5°C.																																									

*2: GRM31CR60J107: 0.15 max.

Continued on the following page.

GRM Series Specifications and Test Methods (2)

Below GRM Series Specifications and Test Methods (2) are applied to "*" PNs in capacitance table.

Continued from the preceding page. In case "*" is not added in capacitance table, please refer to GRM Series Specifications and Test Methods (1) (P.24).

No.	Item	Specifications	Test Method															
14	Appearance	No defects or abnormalities	Preheat the capacitor at 120 to 150°C for 1 minute. Immerse the capacitor in an eutectic solder or Sn-3.0Ag-0.5Cu solder solution at 270±5°C for 10±0.5 seconds. Set at room temperature for 24±2 hours, then measure. *Do not apply to GRM02. •Initial measurement for high dielectric constant type Perform a heat treatment at 150+0/−10°C for one hour and then set at room temperature for 24±2 hours. Perform the initial measurement. *Preheating for GRM32/43/55															
	Capacitance Change	B1, B3, R6, R7, C7, C8: Within ±7.5% F1, F5: Within ±20%																
	D.F.	B1, B3, R6*2, R7, C7, C8: 0.1 max. F1, F5: 0.2 max.																
	I.R.	More than 50Ω · F																
	Dielectric Strength	No defects																
			<table border="1"> <thead> <tr> <th>Step</th> <th>Temperature</th> <th>Time</th> </tr> </thead> <tbody> <tr> <td>1</td> <td>100 to 120°C</td> <td>1 min.</td> </tr> <tr> <td>2</td> <td>170 to 200°C</td> <td>1 min.</td> </tr> </tbody> </table>	Step	Temperature	Time	1	100 to 120°C	1 min.	2	170 to 200°C	1 min.						
Step	Temperature	Time																
1	100 to 120°C	1 min.																
2	170 to 200°C	1 min.																
15	Appearance	No defects or abnormalities	Fix the capacitor to the supporting jig in the same manner and under the same conditions as (10). Perform the five cycles according to the four heat treatments shown in the following table. Set for 24±2 hours at room temperature, then measure. <table border="1"> <thead> <tr> <th>Step</th> <th>1</th> <th>2</th> <th>3</th> <th>4</th> </tr> </thead> <tbody> <tr> <td>Temp. (°C)</td> <td>Min. Operating Temp. +0/−3</td> <td>Room Temp.</td> <td>Max. Operating Temp. +3/−0</td> <td>Room Temp.</td> </tr> <tr> <td>Time (min.)</td> <td>30±3</td> <td>2 to 3</td> <td>30±3</td> <td>2 to 3</td> </tr> </tbody> </table> •Initial measurement for high dielectric constant type Perform a heat treatment at 150+0/−10°C for one hour and then set at room temperature for 24±2 hours. Perform the initial measurement.	Step	1	2	3	4	Temp. (°C)	Min. Operating Temp. +0/−3	Room Temp.	Max. Operating Temp. +3/−0	Room Temp.	Time (min.)	30±3	2 to 3	30±3	2 to 3
	Step	1		2	3	4												
	Temp. (°C)	Min. Operating Temp. +0/−3		Room Temp.	Max. Operating Temp. +3/−0	Room Temp.												
	Time (min.)	30±3		2 to 3	30±3	2 to 3												
	Capacitance Change	B1, B3, R6, R7, C7, C8: Within ±7.5% F1, F5: Within ±20%																
D.F.	B1, B3, R6*2, R7, C7, C8: 0.1 max. F1, F5: 0.2 max.																	
I.R.	More than 50Ω · F																	
Dielectric Strength	No defects																	
16	Appearance	No defects or abnormalities	Apply the rated voltage at 40±2°C and 90 to 95% humidity for 500±12 hours. The charge/discharge current is less than 50mA. •Initial measurement Perform a heat treatment at 150+0/−10°C for one hour and then let sit for 24±2 hours at room temperature. Perform the initial measurement. •Measurement after test Perform a heat treatment at 150+0/−10°C for one hour and then let sit for 24±2 hours at room temperature, then measure.															
	Capacitance Change	B1, B3, R6, R7, C7, C8: Within ±12.5% F1, F5: Within ±30%																
	D.F.	B1, B3, R6, R7, C7, C8: 0.2 max. F1, F5: 0.4 max.																
	I.R.	More than 12.5Ω · F																
17	Appearance	No defects or abnormalities	Apply 150% of the rated voltage for 1000±12 hours at the maximum operating temperature ±3°C. Let sit for 24±2 hours at room temperature, then measure. The charge/discharge current is less than 50mA. •Initial measurement Perform a heat treatment at 150+0/−10°C for one hour and then let sit for 24±2 hours at room temperature. Perform the initial measurement. •Measurement after test Perform a heat treatment at 150+0/−10°C for one hour and then let sit for 24±2 hours at room temperature, then measure.															
	Capacitance Change	B1, B3, R6, R7, C7, C8: Within ±12.5% F1, F5: Within ±30%																
	D.F.	B1, B3, R6, R7, C7, C8: 0.2 max. F1, F5: 0.4 max.																
	I.R.	More than 25Ω · F																

*2: GRM31CR60J107: 0.15 max.

GRM Series Data

■ Capacitance - Temperature Characteristics

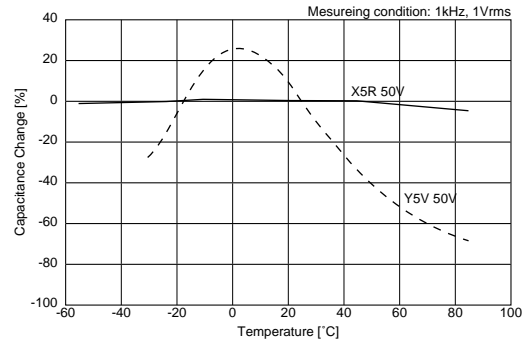
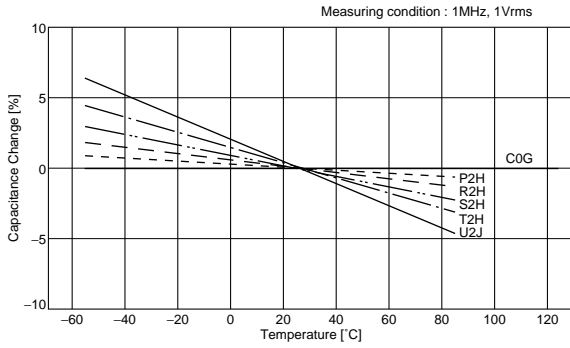

■ Capacitance - DC Voltage Characteristics

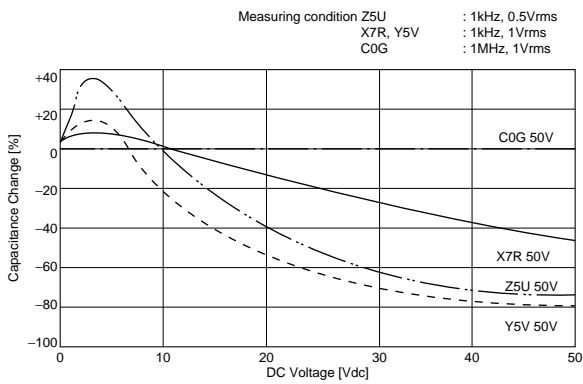

■ Capacitance - AC Voltage Characteristics

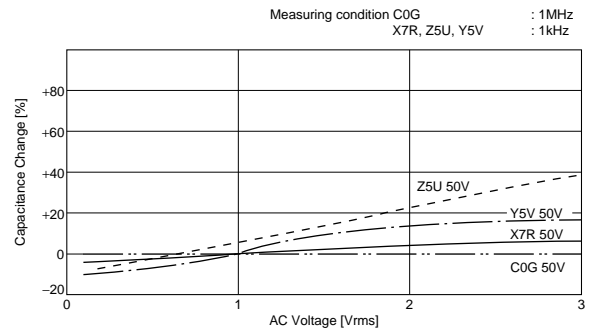

■ Capacitance Change - Aging

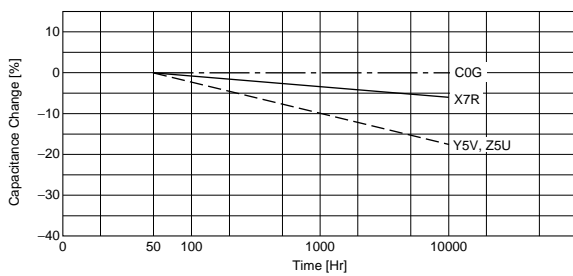

■ Impedance - Frequency Characteristics

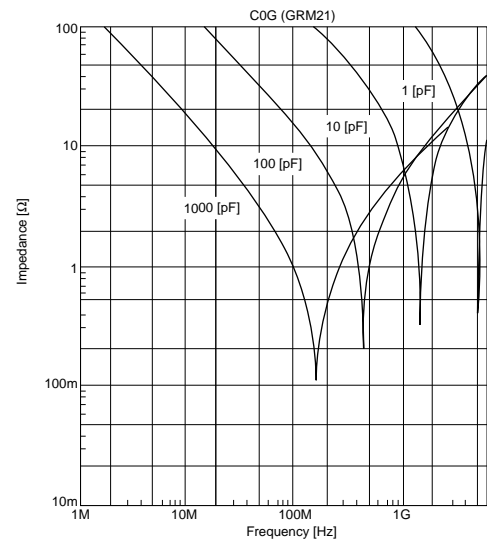

Continued on the following page.

GRM Series Data

Continued from the preceding page.

■ Allowable Voltage - Frequency

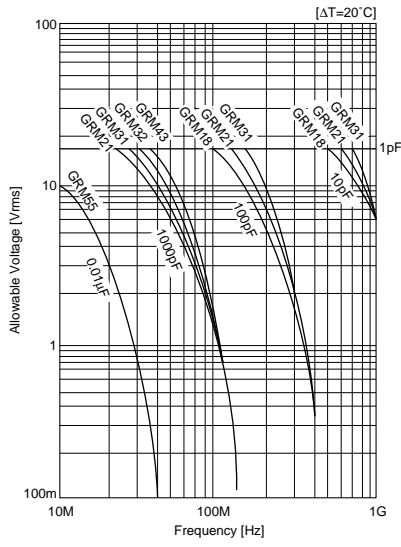

■ Allowable Current - Frequency

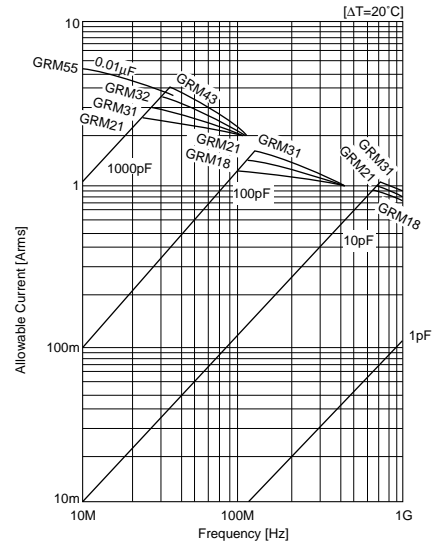

■ Allowable Apparent Power - Frequency

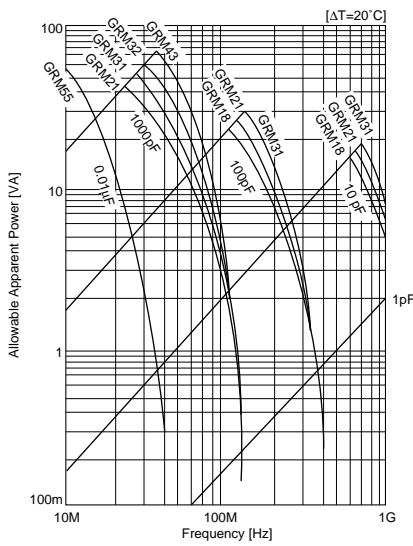

Chip Monolithic Ceramic Capacitors



Microchips GMA Series

■ Features

1. Better microwave characteristics
2. Suitable for by-passing
3. High density mounting

■ Applications

1. Optical device for telecommunication
2. IC, IC packaging built-in
3. Measuring equipment

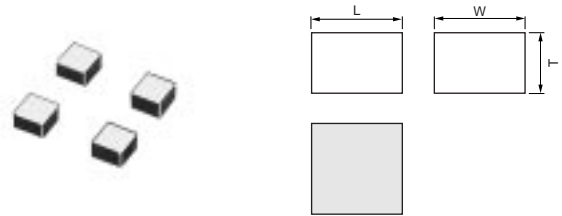

Part Number	Dimensions (mm)		
	L	W	T
GMA05X	0.5 ±0.05	0.5 ±0.05	0.35 ±0.05
GMA085	0.8 ±0.05	0.8 ±0.05	0.5 ±0.1

Part Number	TC Code (Standard)	Rated Voltage (Vdc)	Capacitance	Length L (mm)	Width W (mm)	Thickness T (mm)
GMA05XR72A101MD01	X7R (EIA)	100	100pF ±20%	0.5	0.5	0.35
GMA05XR72A151MD01	X7R (EIA)	100	150pF ±20%	0.5	0.5	0.35
GMA05XR72A221MD01	X7R (EIA)	100	220pF ±20%	0.5	0.5	0.35
GMA05XR72A331MD01	X7R (EIA)	100	330pF ±20%	0.5	0.5	0.35
GMA085R72A331MD01	X7R (EIA)	100	330pF ±20%	0.8	0.8	0.5
GMA085R72A471MD01	X7R (EIA)	100	470pF ±20%	0.8	0.8	0.5
GMA085R72A681MD01	X7R (EIA)	100	680pF ±20%	0.8	0.8	0.5
GMA085R72A102MD01	X7R (EIA)	100	1000pF ±20%	0.8	0.8	0.5
GMA05XR71H161MD01	X7R (EIA)	50	160pF ±20%	0.5	0.5	0.35
GMA05XR71H331MD01	X7R (EIA)	50	330pF ±20%	0.5	0.5	0.35
GMA05XR71H471MD01	X7R (EIA)	50	470pF ±20%	0.5	0.5	0.35
GMA05XR71C431MD01	X7R (EIA)	16	430pF ±20%	0.5	0.5	0.35
GMA05XR71C471MD01	X7R (EIA)	16	470pF ±20%	0.5	0.5	0.35
GMA05XR71C681MD01	X7R (EIA)	16	680pF ±20%	0.5	0.5	0.35
GMA05XR71C102MD01	X7R (EIA)	16	1000pF ±20%	0.5	0.5	0.35
GMA085R71C102MD01	X7R (EIA)	16	1000pF ±20%	0.8	0.8	0.5
GMA05XR71C152MD01	X7R (EIA)	16	1500pF ±20%	0.5	0.5	0.35
GMA085R71C152MD01	X7R (EIA)	16	1500pF ±20%	0.8	0.8	0.5
GMA05XR71C222MD01	X7R (EIA)	16	2200pF ±20%	0.5	0.5	0.35
GMA085R71C222MD01	X7R (EIA)	16	2200pF ±20%	0.8	0.8	0.5
GMA085R71C332MD01	X7R (EIA)	16	3300pF ±20%	0.8	0.8	0.5
GMA085R71C472MD01	X7R (EIA)	16	4700pF ±20%	0.8	0.8	0.5
GMA085R71C682MD01	X7R (EIA)	16	6800pF ±20%	0.8	0.8	0.5
GMA085R71C103MD01	X7R (EIA)	16	10000pF ±20%	0.8	0.8	0.5

Specifications and Test Methods

No.	Item	Specifications	Test Method															
1	Operating Temperature Range	R7: -55 to +125°C	Reference Temperature: 25°C															
2	Rated Voltage	See the previous pages.	The rated voltage is defined as the maximum voltage which may be applied continuously to the capacitor. When AC voltage is superimposed on DC voltage, V^{P-P} or V^{O-P} , whichever is larger, should be maintained within the rated voltage range.															
3	Appearance	No defects or abnormalities	Using calipers															
4	Dimensions	Within the specified dimensions	Visual inspection															
5	Dielectric Strength	No defects or abnormalities	No failure should be observed when a voltage of 250% of the rated voltage is applied between the both terminations for 1 to 5 seconds, provided the charge/discharge current is less than 50mA.															
6	Insulation Resistance	10,000MΩ min.	The insulation resistance should be measured with a DC voltage not exceeding the rated voltage at normal temperature and humidity and within 2 minutes of charging.															
7	Capacitance	Within the specified tolerance	The capacitance/D.F. should be measured at reference temperature at the frequency and voltage shown in the table.															
8	Dissipation Factor (D.F.)	R7: 0.035 max.	<table border="1"> <thead> <tr> <th>Frequency</th> <th></th> </tr> </thead> <tbody> <tr> <td></td> <td>1±0.1kHz</td> </tr> <tr> <th>Voltage</th> <th></th> </tr> <tr> <td></td> <td>1±0.2Vrms</td> </tr> </tbody> </table>	Frequency			1±0.1kHz	Voltage			1±0.2Vrms							
Frequency																		
	1±0.1kHz																	
Voltage																		
	1±0.2Vrms																	
9	Capacitance Temperature Characteristics	No bias R7: Within +/-15% (-55 to +125°C)	<p>The capacitance change should be measured after 5min. at each specified temp. stage.</p> <ul style="list-style-type: none"> The ranges of capacitance change compared with the Reference Temperature value over the temperature ranges shown in the table should be within the specified ranges.* <p>In case of applying voltage, the capacitance change should be measured after 1 more min. with applying voltage in equilibration of each temp. stage.</p> <table border="1"> <thead> <tr> <th>Step</th> <th>Temperature (°C)</th> <th>Applying Voltage (V)</th> </tr> </thead> <tbody> <tr> <td>1</td> <td>Reference Temperature±2</td> <td rowspan="4">No bias</td> </tr> <tr> <td>2</td> <td>-55±3 (for R7) -30±3 (for F5)</td> </tr> <tr> <td>3</td> <td>Reference Temperature±2</td> </tr> <tr> <td>4</td> <td>125±3 (for R7) 85±3 (for F5)</td> </tr> </tbody> </table> <p>*Initial measurement for high dielectric constant type Perform a heat treatment at 150 +0/-10°C for one hour and then let sit for 24±2 hours at room temperature. Perform the initial measurement.</p>	Step	Temperature (°C)	Applying Voltage (V)	1	Reference Temperature±2	No bias	2	-55±3 (for R7) -30±3 (for F5)	3	Reference Temperature±2	4	125±3 (for R7) 85±3 (for F5)			
Step	Temperature (°C)	Applying Voltage (V)																
1	Reference Temperature±2	No bias																
2	-55±3 (for R7) -30±3 (for F5)																	
3	Reference Temperature±2																	
4	125±3 (for R7) 85±3 (for F5)																	
10	Mechanical Strength	Bond Strength Pull force: 0.03N min.	MIL-STD-883 Method 2011 Condition D Mount the capacitor on a gold metallized alumina substrate with Au-Sn (80/20) and bond a 25μm (0.0008 inch) gold wire to the capacitor terminal using an ultrasonic ball bond. Then, pull wire.															
		Die Shear Strength Die Shear force: 2N min.	MIL-STD-883 Method 2019 Mount the capacitor on a gold metallized alumina substrate with Au-Sn (80/20). Apply the force parallel to the substrate.															
11	Vibration Resistance	Appearance	No defects or abnormalities															
		Capacitance	Within the specified tolerance															
		D.F.	R7: 0.035 max.															
12	Temperature Cycle	Appearance	No defects or abnormalities															
		Capacitance Change	R7: Within ±7.5%															
		D.F.	R7: 0.035 max.															
		I.R.	10,000MΩ min.															
		Dielectric Strength	No defects															
			<p>Ramp frequency from 10 to 55Hz then return to 10Hz all within 1 minute. Amplitude: 1.5 mm (0.06 inch) max. total excursion. Apply this motion for a period of 2 hours in each of 3 mutually perpendicular directions (total 6 hours).</p> <table border="1"> <thead> <tr> <th>Step</th> <th>1</th> <th>2</th> <th>3</th> <th>4</th> </tr> </thead> <tbody> <tr> <td>Temp. (°C)</td> <td>Min. Operating Temp. +0/-3</td> <td>Room Temp.</td> <td>Max. Operating Temp. +3/-0</td> <td>Room Temp.</td> </tr> <tr> <td>Time (min.)</td> <td>30±3</td> <td>2 to 3</td> <td>30±3</td> <td>2 to 3</td> </tr> </tbody> </table>	Step	1	2	3	4	Temp. (°C)	Min. Operating Temp. +0/-3	Room Temp.	Max. Operating Temp. +3/-0	Room Temp.	Time (min.)	30±3	2 to 3	30±3	2 to 3
Step	1	2	3	4														
Temp. (°C)	Min. Operating Temp. +0/-3	Room Temp.	Max. Operating Temp. +3/-0	Room Temp.														
Time (min.)	30±3	2 to 3	30±3	2 to 3														

Continued on the following page. 

Specifications and Test Methods

Continued from the preceding page.

No.	Item	Specifications	Test Method
13	Humidity (Steady State)	Appearance	No defects or abnormalities
		Capacitance Change	R7: Within $\pm 12.5\%$
		D.F.	R7: 0.05 max.
		I.R.	1,000M Ω min.
14	Humidity Load	Appearance	No defects or abnormalities
		Capacitance Change	R7: Within $\pm 12.5\%$
		D.F.	R7: 0.05 max.
		I.R.	500M Ω min.
15	High Temperature Load	Appearance	No defects or abnormalities
		Capacitance Change	R7: Within $\pm 12.5\%$
		D.F.	R7: 0.05 max.
		I.R.	1,000M Ω min.

Set the capacitor for 500 \pm 12 hours at 40 \pm 20 $^{\circ}$ C, in 90 to 95% humidity. Take it out and set it for 24 \pm 2 hours at room temperature, then measure.

Apply the rated voltage for 500 \pm 12 hours at 40 \pm 2 $^{\circ}$ C, in 90 to 95% humidity and set it for 24 \pm 2 hours at room temperature, then measure. The charge/discharge current is less than 50mA.

A voltage treatment should be given to the capacitor, in which a DC voltage of 200% the rated voltage is applied for one hour at the maximum operating temperature $\pm 3^{\circ}$ C then it should be set for 24 \pm 2 hours at room temperature and the initial measurement should be conducted. Then apply the above mentioned voltage continuously for 1000 \pm 12 hours at the same temperature, remove it from the bath, and set it for 24 \pm 2 hours at room temperature, then measure. The charge/discharge current is less than 50mA.

Mounting for testing: The capacitors should be mounted on the substrate as shown below using die bonding and wire bonding when tests No.11 to 15 are performed.

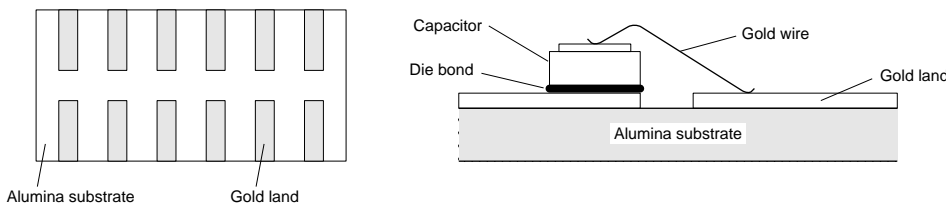

6

Chip Monolithic Ceramic Capacitors



Capacitor Arrays GNM Series

■ Features

1. High density mounting due to mounting space saving
2. Mounting cost saving

■ Applications

General electronic equipment

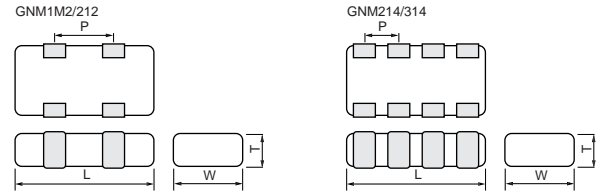

Part Number	Dimensions (mm)			
	L	W	T	P
GNM1M2	1.37 ±0.15	1.0 ±0.15	0.6 ±0.1 0.8 +0/-0.15	0.64 ±0.05
GNM212 GNM214	2.0 ±0.15	1.25 ±0.15	0.85 ±0.1 0.6 ±0.1	1.0 ±0.1 0.5 ±0.05
GNM314	3.2 ±0.15	1.6 ±0.15	0.8 ±0.1 1.0 ±0.1	0.8 ±0.1

Temperature Compensating Type

Part Number	GNM1M		GNM21	GNM31	
L x W	1.37x1.0		2.0x1.25	3.2x1.6	
TC	COG (5C)		COG (5C)	COG (5C)	
Rated Volt.	50 (1H)		50 (1H)	100 (2A)	50 (1H)
Capacitance, Capacitance Tolerance and T Dimension					
10pF(100)	K	0.6(2)	0.6(4)	0.8(4)	0.8(4)
15pF(150)	K	0.6(2)	0.6(4)	0.8(4)	0.8(4)
22pF(220)	K	0.6(2)	0.6(4)	0.8(4)	0.8(4)
27pF(270)	K	0.6(2)	0.6(4)	0.8(4)	0.8(4)
33pF(330)	K	0.6(2)	0.6(4)	0.8(4)	0.8(4)
39pF(390)	K	0.6(2)	0.6(4)	0.8(4)	0.8(4)
47pF(470)	K	0.6(2)	0.6(4)	0.8(4)	0.8(4)
68pF(680)	K	0.6(2)	0.6(4)	0.8(4)	0.8(4)
100pF(101)	K	0.6(2)	0.6(4)	0.8(4)	0.8(4)
150pF(151)	K	0.6(2)	0.6(4)	0.8(4)	0.8(4)
220pF(221)	K	0.6(2)	0.6(4)		0.8(4)
270pF(271)	K				0.8(4)
330pF(331)	K				0.8(4)

The part numbering code is shown in each (). The (4) code in T (mm) means number of elements (four).
 Dimensions are shown in mm and Rated Voltage in Vdc.

High Dielectric Constant Type GNM1M Series

Part Number	GNM1M						
L x W	1.37x1.0						
TC	X5R (R6)			X7R (R7)			
Rated Volt.	16 (1C)	10 (1A)	6.3 (0J)	50 (1H)	25 (1E)	16 (1C)	10 (1A)
Capacitance, Capacitance Tolerance and T Dimension							
1000pF(102)	M			0.6(2)			
2200pF(222)	K, M				0.6(2)		
4700pF(472)	K, M				0.6(2)		
10000pF(103)	M				0.6(2)		
22000pF(223)	K, M	0.6(2)	0.6(2)			0.6(2)	0.6(2)

Continued on the following page.

Continued from the preceding page.

Part Number	GNM1M						
L x W	1.37x1.0						
TC	X5R (R6)			X7R (R7)			
Rated Volt.	16 (1C)	10 (1A)	6.3 (0J)	50 (1H)	25 (1E)	16 (1C)	10 (1A)
Capacitance, Capacitance Tolerance and T Dimension							
47000pF(473)	K, M	0.6(2)	0.6(2)			0.6(2)	0.6(2)
0.10μF(104)	M		0.6(2)				
1.0μF(105)	M	0.8(2)	0.8(2)	0.8(2)			

The part numbering code is shown in each (). The (2) code in T (mm) means number of elements (two).
 Dimensions are shown in mm and Rated Voltage in Vdc.
 Please refer to Specifications and Test Methods (2) about 1.0μF products.

High Dielectric Constant Type GNM21 Series

Part Number	GNM21				
L x W	2.0x1.25				
TC	X5R (R6)		X7R (R7)		
Rated Volt.	16 (1C)	10 (1A)	50 (1H)	25 (1E)	16 (1C)
Capacitance, Capacitance Tolerance and T Dimension					
1000pF(102)	M		0.6(4)		
2200pF(222)	K, M			0.6(4)	
4700pF(472)	K, M			0.6(4)	
10000pF(103)	M			0.6(4)	
22000pF(223)	K, M				0.85(4)
47000pF(473)	K, M				0.85(4)
0.10μF(104)	M				0.85(4)
0.47μF(474)	M	0.85(2)			
1.0μF(105)	M	0.85(2)	0.85(4)		
2.2μF(225)	K, M		0.85(2)		

The part numbering code is shown in each (). The (2) code in T (mm) means number of elements (two).
 Dimensions are shown in mm and Rated Voltage in Vdc.
 Please refer to Specifications and Test Methods (2) about X5R, 10V products.

High Dielectric Constant Type GNM31 Series

Part Number	GNM31			
L x W	3.2x1.6			
TC	X7R (R7)		X5R (R6)	
Rated Volt.	100 (2A)	50 (1H)	16 (1C)	10 (1A)
Capacitance, Capacitance Tolerance and T Dimension				
220pF(221)	K, M	0.8(4)		
330pF(331)	K, M	0.8(4)		
470pF(471)	K, M	0.8(4)	0.8(4)	
680pF(681)	K, M	0.8(4)	0.8(4)	
1000pF(102)	K, M	0.8(4)	0.8(4)	
1500pF(152)	K, M	0.8(4)	0.8(4)	
2200pF(222)	K, M	0.8(4)	0.8(4)	
3300pF(332)	K, M	0.8(4)	0.8(4)	
4700pF(472)	K, M	0.8(4)	0.8(4)	
6800pF(682)	K, M		0.8(4)	
10000pF(103)	K, M		0.8(4)	

Continued on the following page.

 Continued from the preceding page.

Part Number	GNM31			
L x W	3.2x1.6			
TC	X7R (R7)			X5R (R6)
Rated Volt.	100 (2A)	50 (1H)	16 (1C)	10 (1A)
Capacitance, Capacitance Tolerance and T Dimension				
15000pF(153)	K, M		0.8(4)	
22000pF(223)	K, M		0.8(4)	
33000pF(333)	K, M		0.8(4)	
47000pF(473)	K, M		1.0(4)	
68000pF(683)	K, M		1.0(4)	
0.10μF(104)	K, M		1.0(4)	
1.0μF(105)	M			0.85(4)

The part numbering code is shown in each (). The (4) code in T (mm) means number of elements (four).
 Dimensions are shown in mm and Rated Voltage in Vdc.

GNM Series Specifications and Test Methods (1)

No.	Item	Specifications		Test Method																						
		Temperature Compensating Type	High Dielectric Type																							
1	Operating Temperature Range	5C: -55 to +125°C	R7: -55 to +125°C R6: -30 to +85°C																							
2	Rated Voltage	See the previous pages.		The rated voltage is defined as the maximum voltage which may be applied continuously to the capacitor. When AC voltage is superimposed on DC voltage, V^{P-P} or V^{O-P} , whichever is larger, should be maintained within the rated voltage range.																						
3	Appearance	No defects or abnormalities		Visual inspection																						
4	Dimensions	Within the specified dimensions		Using calipers																						
5	Dielectric Strength	No defects or abnormalities		No failure should be observed when 300% of the rated voltage (5C) or 250% of the rated voltage (R7) is applied between the terminations for 1 to 5 seconds, provided the charge/discharge current is less than 50mA.																						
6	Insulation Resistance	More than 10,000MΩ or 500Ω · F (Whichever is smaller)		The insulation resistance should be measured with a DC voltage not exceeding the rated voltage at 25°C and 75%RH max. and within 2 minutes of charging.																						
7	Capacitance	Within the specified tolerance		The capacitance/Q/D.F. should be measured at 25°C at the frequency and voltage shown in the table.																						
8	Q/ Dissipation Factor (D.F.)	30pF min.: $Q \geq 1000$ 30pF max.: $Q \geq 400+20C$ C: Nominal Capacitance (pF)	<table border="1" style="font-size: small;"> <tr> <th>Char.</th> <th>25V min.</th> <th>16V</th> <th>10V</th> <th>6.3V</th> </tr> <tr> <td>R7, R6</td> <td>0.025 max.</td> <td>0.035 max.</td> <td>0.035 max.</td> <td>0.05 max.</td> </tr> </table>	Char.	25V min.	16V	10V	6.3V	R7, R6	0.025 max.	0.035 max.	0.035 max.	0.05 max.	<table border="1" style="font-size: small;"> <tr> <th>Char.</th> <th>5C</th> <th>R7</th> </tr> <tr> <td>Item</td> <td></td> <td></td> </tr> <tr> <td>Frequency</td> <td>1±0.1MHz</td> <td>1±0.1kHz</td> </tr> <tr> <td>Voltage</td> <td>0.5 to 5Vrms</td> <td>1.0±0.2Vrms</td> </tr> </table>	Char.	5C	R7	Item			Frequency	1±0.1MHz	1±0.1kHz	Voltage	0.5 to 5Vrms	1.0±0.2Vrms
			Char.	25V min.	16V	10V	6.3V																			
R7, R6	0.025 max.	0.035 max.	0.035 max.	0.05 max.																						
Char.	5C	R7																								
Item																										
Frequency	1±0.1MHz	1±0.1kHz																								
Voltage	0.5 to 5Vrms	1.0±0.2Vrms																								
9	Capacitance Temperature Characteristics	Capacitance Change	<table border="1" style="font-size: small;"> <tr> <th>Char.</th> <th>Temp. Range</th> <th>Reference Temp.</th> <th>Cap. Change</th> </tr> <tr> <td>R7</td> <td>-55°C to +125°C</td> <td rowspan="2">25°C</td> <td rowspan="2">Within ±15%</td> </tr> <tr> <td>R6</td> <td>-55°C to +85°C</td> </tr> </table>	Char.	Temp. Range	Reference Temp.	Cap. Change	R7	-55°C to +125°C	25°C	Within ±15%	R6	-55°C to +85°C	The capacitance change should be measured after 5 min. at each specified temperature stage. (1) Temperature Compensating Type The temperature coefficient is determined using the capacitance measured in step 3 as a reference. When cycling the temperature sequentially from step1 through 5, the capacitance should be within the specified tolerance for the temperature coefficient and capacitance change as Table A. The capacitance drift is calculated by dividing the differences between the maximum and minimum measured values in the steps 1, 3 and 5 by the cap. value in step 3.												
		Char.	Temp. Range	Reference Temp.	Cap. Change																					
		R7	-55°C to +125°C	25°C	Within ±15%																					
R6	-55°C to +85°C																									
Temperature Coefficient	Within the specified tolerance (Table A)																									
Capacitance Drift	Within ±0.2% or ±0.05pF (Whichever is larger.)																									
10	Adhesive Strength of Termination	No removal of the terminations or other defect should occur.		Solder the capacitor to the test jig (glass epoxy board) shown in Fig.1 using a eutectic solder. Then apply 5N force in parallel with the test jig for 10±1 sec. The soldering should be done either with an iron or using the reflow method and should be conducted with care so that the soldering is uniform and free of defects such as heat shock.																						
			<table border="1" style="font-size: small;"> <tr> <th>Type</th> <th>a</th> <th>b</th> <th>c</th> <th>d</th> </tr> <tr> <td>GNM1M2</td> <td>0.5</td> <td>1.6</td> <td>0.32</td> <td>0.32</td> </tr> <tr> <td>GNM212</td> <td>0.6</td> <td>1.8</td> <td>0.5</td> <td>0.5</td> </tr> <tr> <td>GNM214</td> <td>0.6</td> <td>2.0</td> <td>0.25</td> <td>0.25</td> </tr> <tr> <td>GNM314</td> <td>0.8</td> <td>2.5</td> <td>0.4</td> <td>0.4</td> </tr> </table> <p style="text-align: right;">(in mm)</p>		Type	a	b	c	d	GNM1M2	0.5	1.6	0.32	0.32	GNM212	0.6	1.8	0.5	0.5	GNM214	0.6	2.0	0.25	0.25	GNM314	0.8
Type	a	b	c	d																						
GNM1M2	0.5	1.6	0.32	0.32																						
GNM212	0.6	1.8	0.5	0.5																						
GNM214	0.6	2.0	0.25	0.25																						
GNM314	0.8	2.5	0.4	0.4																						

Fig. 1

Continued on the following page.

GNM Series Specifications and Test Methods (1)

Continued from the preceding page.

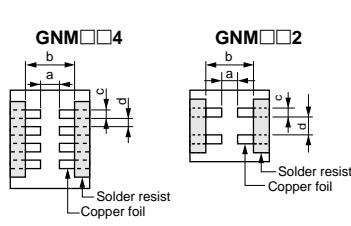
No.	Item	Specifications				Test Method																						
		Temperature Compensating Type	High Dielectric Type																									
11	Appearance	No defects or abnormalities				Solder the capacitor to the test jig (glass epoxy board) in the same manner and under the same conditions as (10). The capacitor should be subjected to a simple harmonic motion having a total amplitude of 1.5mm, the frequency being varied uniformly between the approximate limits of 10 and 55Hz. The frequency range, from 10 to 55Hz and return to 10Hz, should be traversed in approximately 1 minute. This motion should be applied for a period of 2 hours in each of 3 mutually perpendicular directions (total of 6 hours).																						
	Capacitance	Within the specified tolerance																										
11	Vibration Resistance	Q/D.F.	30pF min.: $Q \geq 1000$ 30pF max.: $Q \geq 400+20C$ C: Nominal Capacitance (pF)	Char.	25V min.	16V	10V	6.3V																				
				R7, R6	0.025 max.	0.035 max.	0.035 max.	0.05 max.																				
12	Deflection	No cracking or marking defects should occur.				Solder the capacitor on the test jig (glass epoxy board) shown in Fig. 2 using a eutectic solder. Then apply a force in the direction shown in Fig. 3 for 5±1 sec. The soldering should be done by the reflow method and should be conducted with care so that the soldering is uniform and free of defects such as heat shock.																						
		<table border="1" style="margin: 10px auto; border-collapse: collapse;"> <thead> <tr> <th>Type</th> <th>a</th> <th>b</th> <th>c</th> <th>d</th> </tr> </thead> <tbody> <tr> <td>GNM1M2</td> <td>2.0±0.05</td> <td>0.5±0.05</td> <td>0.32±0.05</td> <td>0.32±0.05</td> </tr> <tr> <td>GNM212</td> <td>2.0±0.05</td> <td>0.6±0.05</td> <td>0.5±0.05</td> <td>0.5±0.05</td> </tr> <tr> <td>GNM214</td> <td>2.0±0.05</td> <td>0.7±0.05</td> <td>0.3±0.05</td> <td>0.2±0.05</td> </tr> <tr> <td>GNM314</td> <td>2.5±0.05</td> <td>0.8±0.05</td> <td>0.4±0.05</td> <td>0.4±0.05</td> </tr> </tbody> </table> <p style="text-align: center;">(in mm)</p>					Type	a	b	c	d	GNM1M2	2.0±0.05	0.5±0.05	0.32±0.05	0.32±0.05	GNM212	2.0±0.05	0.6±0.05	0.5±0.05	0.5±0.05	GNM214	2.0±0.05	0.7±0.05	0.3±0.05	0.2±0.05	GNM314	2.5±0.05
Type	a	b	c	d																								
GNM1M2	2.0±0.05	0.5±0.05	0.32±0.05	0.32±0.05																								
GNM212	2.0±0.05	0.6±0.05	0.5±0.05	0.5±0.05																								
GNM214	2.0±0.05	0.7±0.05	0.3±0.05	0.2±0.05																								
GNM314	2.5±0.05	0.8±0.05	0.4±0.05	0.4±0.05																								
13	Solderability of Termination	75% of the terminations are to be soldered evenly and continuously.				Immerse the capacitor in a solution of ethanol (JIS-K-8101) and rosin (JIS-K-5902) (25% rosin in weight proportion). Preheat at 80 to 120°C for 10 to 30 seconds. After preheating, immerse in eutectic solder solution for 2±0.5 seconds at 230±5°C or Sn-3.0Ag-0.5Cu solder solution for 2±0.5 seconds at 245±5°C.																						
14	Resistance to Soldering Heat	The measured and observed characteristics should satisfy the specifications in the following table.				Preheat the capacitor at 120 to 150°C for 1 minute. Immerse the capacitor in a eutectic solder or Sn-3.0Ag-0.5Cu solder solution at 270±5°C for 10±0.5 seconds. Let sit at room temperature for 24±2 hours, then measure. • Initial measurement for high dielectric constant type Perform a heat treatment at 150+0/-10°C for one hour and then let sit for 24±2 hours at room temperature. Perform the initial measurement.																						
	Appearance	No marking defects																										
	Capacitance Change	Within ±2.5% or ±0.25pF (Whichever is larger)	R7, R6: Within ±7.5%																									
	Q/D.F.	30pF min.: $Q \geq 1000$ 30pF max.: $Q \geq 400+20C$ C: Nominal Capacitance (pF)	Char.	25V min.	16V		10V	6.3V																				
	I.R.	More than 10,000MΩ or 500Ω · F (Whichever is smaller)																										
	Dielectric Strength	No failure																										

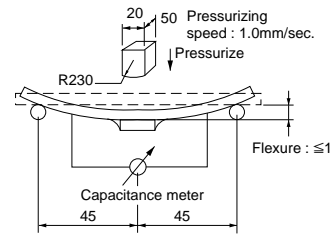

Fig. 3

Continued on the following page.

GNM Series Specifications and Test Methods (1)

Continued from the preceding page.

No.	Item	Specifications					Test Method	
		Temperature Compensating Type	High Dielectric Type					
15	Temperature Cycle	The measured and observed characteristics should satisfy the specifications in the following table.					Fix the capacitor to the supporting jig in the same manner and under the same conditions as (10). Perform the five cycles according to the four heat treatments listed in the following table. Let sit for 24±2 hours (temperature compensating type) or 48±4 hours (high dielectric constant type) at room temperature, then measure.	
	Appearance	No marking defects						
	Capacitance Change	Within ±2.5% or ±0.25pF (Whichever is larger)	R7, R6: Within ±7.5%					
	Q/D.F.	30pF min.: Q≥1000 30pF max.: Q≥400+20C C: Nominal Capacitance (pF)	Char.	25V min.	16V	10V		6.3V
			R7, R6	0.025 max.	0.035 max.	0.035 max.		0.05 max.
	I.R.	More than 10,000MΩ or 500Ω · F (Whichever is smaller)						
Dielectric Strength	No failure							
16	Humidity Steady State	The measured and observed characteristics should satisfy the specifications in the following table.					Sit the capacitor at 40±2°C and 90 to 95% humidity for 500±12 hours. Remove and let sit for 24±2 hours at room temperature, then measure.	
	Appearance	No marking defects						
	Capacitance Change	Within ±5% or ±0.5pF (Whichever is larger)	R7, R6: Within ±12.5%					
	Q/D.F.	30pF and over: Q≥350 10pF and over, 30pF and below: Q≥275+5C/2 10pF and below: Q≥200+10C C: Nominal Capacitance (pF)	Char.	25V min.	16V	10V/6.3V		
			R7, R6	0.05 max.	0.05 max.	0.05 max.		
	I.R.	More than 1,000MΩ or 50Ω · F (Whichever is smaller)						
Dielectric Strength	No failure							
17	Humidity Load	The measured and observed characteristics should satisfy the specifications in the following table.					Apply the rated voltage at 40±2°C and 90 to 95% humidity for 500±12 hours. Remove and let sit for 24±2 hours at room temperature, then measure. The charge/discharge current is less than 50mA.	
	Appearance	No marking defects						
	Capacitance Change	Within ±7.5% or ±0.75pF (Whichever is larger)	R7, R6: Within ±12.5%					
	Q/D.F.	30pF and over: Q≥200 30pF and below: Q≥100+10C/3 C: Nominal Capacitance (pF)	Char.	25V min.	16V	10V/6.3V		
			R7, R6	0.05 max.	0.05 max.	0.05 max.		
	I.R.	More than 500MΩ or 25Ω · F (Whichever is smaller)						
Dielectric Strength	No failure							

Continued on the following page.

7

GNM Series Specifications and Test Methods (1)

Continued from the preceding page.

No.	Item	Specifications				Test Method								
		Temperature Compensating Type	High Dielectric Type											
18	High Temperature Load	The measured and observed characteristics should satisfy the specifications in the following table.				Apply 200% of the rated voltage for 1000±12 hours at the maximum operating temperature ±3°C. Let sit for 24±2 hours at room temperature, then measure. The charge/discharge current is less than 50mA. • Initial measurement for high dielectric constant type. Apply 200% of the rated DC voltage for one hour at the maximum operating temperature ±3°C. Remove and let sit for 24±2 hours at room temperature. Perform initial measurement.								
	Appearance	No marking defects												
	Capacitance Change	Within ±3% or ±0.3pF (Whichever is larger)	R7, R6: Within ±12.5%											
	Q/D.F.	30pF and over: Q≥350 10pF and over, 30pF and below: Q≥275+5C/2 10pF and below: Q≥200+10C C: Nominal Capacitance (pF)	<table border="1" style="font-size: small; border-collapse: collapse;"> <thead> <tr> <th style="width: 5%;">Char.</th> <th style="width: 15%;">25V min.</th> <th style="width: 15%;">16V</th> <th style="width: 15%;">10V/6.3V</th> </tr> </thead> <tbody> <tr> <td style="text-align: center;">R7, R6</td> <td style="text-align: center;">0.04 max.</td> <td style="text-align: center;">0.05 max.</td> <td style="text-align: center;">0.05 max.</td> </tr> </tbody> </table>	Char.	25V min.		16V	10V/6.3V	R7, R6	0.04 max.	0.05 max.	0.05 max.		
	Char.	25V min.	16V	10V/6.3V										
R7, R6	0.04 max.	0.05 max.	0.05 max.											
I.R.	More than 1,000MΩ or 50Ω · F (Whichever is smaller)													

Table A

Char.	Nominal Values (ppm/°C) Note 1	Capacitance Change from 25°C (%)					
		-55°C		-30°C		-10°C	
		Max.	Min.	Max.	Min.	Max.	Min.
5C	0±30	0.58	-0.24	0.40	-0.17	0.25	-0.11

Note 1: Nominal values denote the temperature coefficient within a range of 25 to 125°C.

7

GNM Series Specifications and Test Methods (2)

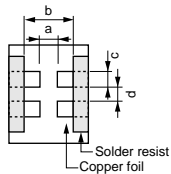
No.	Item	Specifications	Test Method																				
1	Operating Temperature Range	R6: -55°C to +85°C																					
2	Rated Voltage	See the previous pages.	The rated voltage is defined as the maximum voltage which may be applied continuously to the capacitor. When AC voltage is superimposed on DC voltage, V^{P-P} or V^{O-P} , whichever is larger, should be maintained within the rated voltage range.																				
3	Appearance	No defects or abnormalities	Visual inspection																				
4	Dimensions	Within the specified dimension	Using calipers																				
5	Dielectric Strength	No defects or abnormalities	No failure should be observed when 250% of the rated voltage is applied between the terminations for 1 to 5 seconds, provided the charge/discharge current is less than 50mA.																				
6	Insulation Resistance	50Ω · F min.	The insulation resistance should be measured with a DC voltage not exceeding the rated voltage at 25°C and 75%RH max. and within 1 minute of charging.																				
7	Capacitance	Within the specified tolerance	The capacitance/D.F. should be measured at 25°C at the frequency and voltage shown in the table.																				
8	Dissipation Factor (D.F.)	0.1 max.	<table border="1" style="margin-left: auto; margin-right: auto;"> <thead> <tr> <th>Capacitance</th> <th>Frequency</th> <th>Voltage</th> </tr> </thead> <tbody> <tr> <td>R6</td> <td>1±0.1kHz</td> <td>0.5±0.1Vrms</td> </tr> </tbody> </table>	Capacitance	Frequency	Voltage	R6	1±0.1kHz	0.5±0.1Vrms														
Capacitance	Frequency	Voltage																					
R6	1±0.1kHz	0.5±0.1Vrms																					
9	Capacitance Temperature Characteristics	<table border="1" style="margin-left: auto; margin-right: auto;"> <thead> <tr> <th>Char.</th> <th>Temp. Range</th> <th>Reference Temp.</th> <th>Cap. Change</th> </tr> </thead> <tbody> <tr> <td>R6</td> <td>-55 to +85°C</td> <td>25°C</td> <td>Within ±15%</td> </tr> </tbody> </table>	Char.	Temp. Range	Reference Temp.	Cap. Change	R6	-55 to +85°C	25°C	Within ±15%	<p>The capacitance change should be measured after 5 min. at each specified temperature stage.</p> <table border="1" style="margin-left: auto; margin-right: auto;"> <thead> <tr> <th>Step</th> <th>Temperature (°C)</th> </tr> </thead> <tbody> <tr> <td>1</td> <td>25±2</td> </tr> <tr> <td>2</td> <td>-55±3</td> </tr> <tr> <td>3</td> <td>25±2</td> </tr> <tr> <td>4</td> <td>85±3</td> </tr> <tr> <td>5</td> <td>25±2</td> </tr> </tbody> </table> <p>The ranges of capacitance change compared with the 25°C value over the temperature ranges shown in the table should be within the specified ranges.</p> <ul style="list-style-type: none"> Initial measurement for high dielectric constant type. Perform a heat treatment at 150+0/-10°C for one hour and then set for 24±2 hours at room temperature. Perform the initial measurement. 	Step	Temperature (°C)	1	25±2	2	-55±3	3	25±2	4	85±3	5	25±2
Char.	Temp. Range	Reference Temp.	Cap. Change																				
R6	-55 to +85°C	25°C	Within ±15%																				
Step	Temperature (°C)																						
1	25±2																						
2	-55±3																						
3	25±2																						
4	85±3																						
5	25±2																						
10	Adhesive Strength of Termination	<p>No removal of the terminations or other defects should occur.</p> <div style="text-align: center;">  <p>Fig. 1</p> </div>	<p>Solder the capacitor to the test jig (glass epoxy board) shown in Fig. 1 using a eutectic solder.</p> <p>Then apply 5N force in parallel with the test jig for 10±1 sec. The soldering should be done either with an iron or using the reflow method and should be conducted with care so that the soldering is uniform and free of defects such as heat shock.</p> <table border="1" style="margin-left: auto; margin-right: auto;"> <thead> <tr> <th>Type</th> <th>a</th> <th>b</th> <th>c</th> <th>d</th> </tr> </thead> <tbody> <tr> <td>GNM1M2</td> <td>0.5</td> <td>1.6</td> <td>0.32</td> <td>0.32</td> </tr> <tr> <td>GNM212</td> <td>0.6</td> <td>1.8</td> <td>0.5</td> <td>0.5</td> </tr> </tbody> </table> <p style="text-align: right;">(in mm)</p>	Type	a	b	c	d	GNM1M2	0.5	1.6	0.32	0.32	GNM212	0.6	1.8	0.5	0.5					
Type	a	b	c	d																			
GNM1M2	0.5	1.6	0.32	0.32																			
GNM212	0.6	1.8	0.5	0.5																			
11	Vibration	Appearance	No defects or abnormalities																				
		Capacitance	Within the specified tolerance																				
		D.F.	0.1 max.																				
			<p>Solder the capacitor to the test jig (glass epoxy board) in the same manner and under the same conditions as (10). The capacitor should be subjected to a simple harmonic motion having a total amplitude of 1.5mm, the frequency being varied uniformly between the approximate limits of 10 and 55Hz. The frequency range, from 10 to 55Hz and return to 10Hz, should be traversed in approximately 1 minute. This motion should be applied for a period of 2 hours in each of 3 mutually perpendicular directions (total of 6 hours).</p>																				

Continued on the following page.

GNM Series Specifications and Test Methods (2)

Continued from the preceding page.

No.	Item	Specifications	Test Method																
12	Deflection	No cracking or marking defects should occur. <div style="text-align: center; margin-top: 10px;"> <p>Fig. 3</p> </div>	Solder the capacitor to the test jig (glass epoxy board) shown in Fig. 2 using a eutectic solder. Then apply a force in the direction shown in Fig. 3. The soldering should be done by the reflow method and should be conducted with care so that the soldering is uniform and free of defects such as heat shock. <div style="text-align: center; margin-top: 10px;"> <table border="1" style="margin: 10px auto; border-collapse: collapse;"> <thead> <tr> <th>Type</th> <th>a</th> <th>b</th> <th>c</th> <th>d</th> </tr> </thead> <tbody> <tr> <td>GNM1M2</td> <td>2.0±0.5</td> <td>0.5±0.05</td> <td>0.32±0.05</td> <td>0.32±0.05</td> </tr> <tr> <td>GNM212</td> <td>2.0±0.05</td> <td>0.6±0.05</td> <td>0.5±0.05</td> <td>0.5±0.05</td> </tr> </tbody> </table> <p style="text-align: right;">(in mm)</p> <p>Fig. 2</p> </div>	Type	a	b	c	d	GNM1M2	2.0±0.5	0.5±0.05	0.32±0.05	0.32±0.05	GNM212	2.0±0.05	0.6±0.05	0.5±0.05	0.5±0.05	
		Type	a	b	c	d													
GNM1M2	2.0±0.5	0.5±0.05	0.32±0.05	0.32±0.05															
GNM212	2.0±0.05	0.6±0.05	0.5±0.05	0.5±0.05															
13	Solderability of Termination	75% of the terminations are to be soldered evenly and continuously.	Immerse the capacitor in a solution of ethanol (JIS-K-8101) and rosin (JIS-K-5902) (25% rosin in weight proportion). Preheat at 80 to 120°C for 10 to 30 seconds. After preheating, immerse in eutectic solder solution for 2±0.5 seconds at 230±5°C or Sn-3.0Ag-0.5Cu solder solution for 2±0.5 seconds at 245±5°C.																
14	Resistance to Soldering Heat	Appearance	No marking defects	Preheat the capacitor at 120 to 150°C for 1 minute. Immerse the capacitor in a eutectic solder or Sn-3.0Ag-0.5Cu solder solution at 270±5°C for 10±0.5 seconds. Let sit at room temperature for 24±2 hours, then measure. <ul style="list-style-type: none"> • Initial measurement Perform a heat treatment at 150 +0/-10°C for one hour and then let sit for 24±2 hours at room temperature. Perform the initial measurement. 															
		Capacitance Change	R6: Within ±7.5%																
		D.F.	0.1 max.																
		I.R.	50Ω · F min.																
		Dielectric Strength	No failure																
15	Temperature Cycle	Appearance	No marking defects	Fix the capacitor to the supporting jig in the same manner and under the same conditions as (10). Perform the five cycles according to the four heat treatments listed in the following table. Let sit for 24±2 hours at room temperature, then measure. <table border="1" style="margin: 10px auto; border-collapse: collapse;"> <thead> <tr> <th>Step</th> <th>1</th> <th>2</th> <th>3</th> <th>4</th> </tr> </thead> <tbody> <tr> <td>Temp. (°C)</td> <td>Min. Operating Temp.</td> <td>Room Temp.</td> <td>Max. Operating Temp.</td> <td>Room Temp.</td> </tr> <tr> <td>Time (min.)</td> <td>30±3</td> <td>2 to 3</td> <td>30±3</td> <td>2 to 3</td> </tr> </tbody> </table> <ul style="list-style-type: none"> • Initial measurement Perform a heat treatment at 150 +0/-10 °C for one hour and then let sit for 24±2 hours at room temperature. Perform the initial measurement. 	Step	1	2	3	4	Temp. (°C)	Min. Operating Temp.	Room Temp.	Max. Operating Temp.	Room Temp.	Time (min.)	30±3	2 to 3	30±3	2 to 3
		Step	1		2	3	4												
		Temp. (°C)	Min. Operating Temp.		Room Temp.	Max. Operating Temp.	Room Temp.												
		Time (min.)	30±3		2 to 3	30±3	2 to 3												
		Capacitance Change	R6: Within ±12.5%																
D.F.	0.1 max.																		
I.R.	50Ω · F min.																		
Dielectric Strength	No failure																		
16	High Temperature High Humidity (Steady)	Appearance	No marking defects	Apply the rated voltage at 40±2°C and 90 to 95% humidity for 500±12 hours. The charge/discharge current is less than 50mA. <ul style="list-style-type: none"> • Initial measurement Perform a heat treatment at 150 +0/-10°C for one hour and then let sit for 24±2 hours at room temperature. Perform the initial measurement. • Measurement after test Perform a heat treatment at 150 +0/-10°C for one hour and then let sit for 24±2 hours at room temperature, then measure. 															
		Capacitance Change	R6: Within ±12.5%																
		D.F.	0.2 max.																
		I.R.	12.5Ω · F min.																
		Dielectric Strength	No failure																
17	Durability	Appearance	No marking defects	Apply 125% of the rated voltage for 1000±12 hours at the maximum operating temperature ±3°C. Let sit for 24±2 hours at room temperature, then measure. The charge/discharge current is less than 50mA. <ul style="list-style-type: none"> • Initial measurement Perform a heat treatment at 150 +0/-10°C for one hour and then let sit for 24±2 hours at room temperature. Perform the initial measurement. • Measurement after test Perform a heat treatment at 150 +0/-10°C for one hour and then let sit for 24±2 hours at room temperature, then measure. 															
		Capacitance Change	R6: Within ±12.5%																
		D.F.	0.2 max.																
		I.R.	25Ω · F min.																
		Dielectric Strength	No failure																

7

Chip Monolithic Ceramic Capacitors



for Ultrasonic Sensors GRM Series

■ Features

1. Proper to compensate for ultrasonic sensor
2. Small chip size and high cap. value

■ Applications

Ultrasonic sensor
 (Back sonar, Corner sonar, etc.)

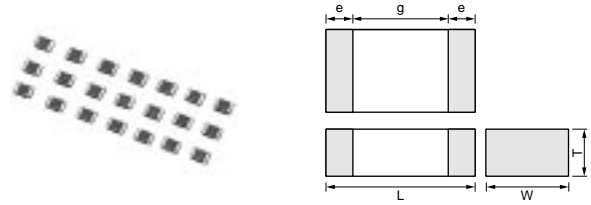

Part Number	Dimensions (mm)				
	L	W	T	e	g min.
GRM219	2.0 ±0.1	1.25 ±0.1	0.85 ±0.1	0.2 to 0.7	0.7

Part Number	TC Code	Rated Voltage (Vdc)	Capacitance (pF)	Length L (mm)	Width W (mm)	Thickness T (mm)
GRM2199E2A102KD42	ZLM (Murata)	100	1000 ±10%	2.0	1.25	0.85
GRM2199E2A152KD42	ZLM (Murata)	100	1500 ±10%	2.0	1.25	0.85

Specifications and Test Methods

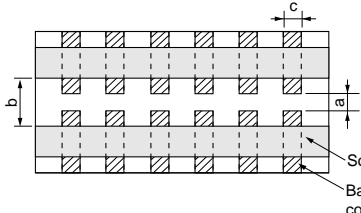
No.	Item	Specifications	Test Method												
1	Operating Temperature	-25 to +85°C	Reference Temperature: 20°C												
2	Rated Voltage	See the previous pages.	The rated voltage is defined as the maximum voltage which may be applied continuously to the capacitor. When AC voltage is superimposed on DC voltage, V^{P-P} or V^{O-P} , whichever is larger, should be maintained within the rated voltage range.												
3	Appearance	No defects or abnormalities	Visual inspection												
4	Dimensions	Within the specified dimensions	Using calipers												
5	Dielectric Strength	No defects or abnormalities	No failure should be observed when 300% of the rated voltage is applied between the terminations for 1 to 5 seconds, provided the charge/discharge current is less than 50mA.												
6	Insulation Resistance (I.R.)	More than 10,000MΩ	The insulation resistance should be measured with a DC voltage not exceeding the rated voltage at 20°C and 75%RH max. and within 2 minutes of charging.												
7	Capacitance	Within the specified tolerance	The capacitance/D.F. should be measured at 20°C with 1 ± 0.1 kHz in frequency and 1 ± 0.2 Vrms in voltage.												
8	Dissipation Factor (D.F.)	0.01 max.													
9	Capacitance Temperature Characteristics	Within $-4,700 \pm 1,999$ ppm/°C (at -25 to +20°C) Within $-4,700 \pm 999$ ppm/°C (at +20 to +85°C)	The temperature coefficient is determined using the capacitance measured in step 1 as a reference. When cycling the temperature sequentially from step 1 through 5, the capacitance should be within the specified tolerance for the temperature coefficient. The capacitance change should be measured after 5 min. at each specified temperature stage. <table border="1" style="margin-left: auto; margin-right: auto;"> <thead> <tr> <th>Step</th> <th>Temperature (°C)</th> </tr> </thead> <tbody> <tr> <td>1</td> <td>20±2</td> </tr> <tr> <td>2</td> <td>-25±3</td> </tr> <tr> <td>3</td> <td>20±2</td> </tr> <tr> <td>4</td> <td>85±3</td> </tr> <tr> <td>5</td> <td>20±2</td> </tr> </tbody> </table>	Step	Temperature (°C)	1	20±2	2	-25±3	3	20±2	4	85±3	5	20±2
Step	Temperature (°C)														
1	20±2														
2	-25±3														
3	20±2														
4	85±3														
5	20±2														
10	Adhesive Strength of Termination	No removal of the terminations or other defect should occur.	Solder the capacitor to the test jig (glass epoxy board) shown in Fig.1 using a eutectic solder. Then apply 10N force in the direction of the arrow. The soldering should be done either with an iron or using the reflow method and should be conducted with care so that the soldering is uniform and free of defects such as heat shock.  <table border="1" style="margin-left: auto; margin-right: auto;"> <thead> <tr> <th>Type</th> <th>a</th> <th>b</th> <th>c</th> </tr> </thead> <tbody> <tr> <td>GRM21</td> <td>1.2</td> <td>4.0</td> <td>1.65</td> </tr> </tbody> </table> <p style="text-align: right;">(in mm)</p>	Type	a	b	c	GRM21	1.2	4.0	1.65				
Type	a	b	c												
GRM21	1.2	4.0	1.65												
11	Vibration Resistance	Appearance	No defects or abnormalities												
		Capacitance	Within the specified tolerance												
		D.F.	0.01 max.												
			Solder the capacitor to the test jig (glass epoxy board) in the same manner and under the same conditions as (10). The capacitor should be subjected to a simple harmonic motion having a total amplitude of 1.5mm, the frequency being varied uniformly between the approximate limits of 10 and 55Hz. The frequency range, from 10 to 55Hz and return to 10Hz, should be traversed in approximately 1 minute. This motion should be applied for a period of 2 hours in each of 3 mutually perpendicular directions (total of 6 hours).												

Continued on the following page.

Specifications and Test Methods

Continued from the preceding page.

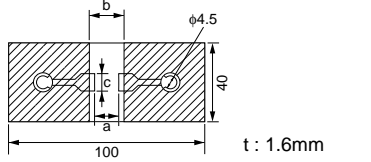
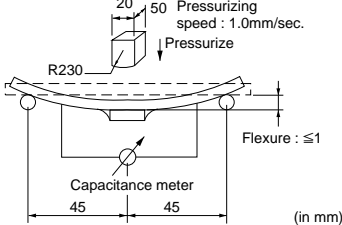
No.	Item	Specifications	Test Method					
12	Deflection	No cracking or marking defects should occur.	Solder the capacitor to the test jig (glass epoxy boards) shown in Fig. 2 using a eutectic solder. Then apply a force in the direction shown in Fig. 3. The soldering should be done by the reflow method and should be conducted with care so that the soldering is uniform and free of defects such as heat shock.					
		 <table border="1" style="margin: 10px auto; border-collapse: collapse;"> <thead> <tr> <th style="padding: 2px;">Type</th> <th style="padding: 2px;">a</th> <th style="padding: 2px;">b</th> <th style="padding: 2px;">c</th> </tr> </thead> <tbody> <tr> <td style="padding: 2px;">GRM21</td> <td style="padding: 2px;">1.2</td> <td style="padding: 2px;">4.0</td> <td style="padding: 2px;">1.65</td> </tr> </tbody> </table> <p style="text-align: center; margin-top: 5px;">(in mm)</p> <p style="text-align: center; margin-top: 5px;">Fig. 2</p>		Type	a	b	c	GRM21
Type	a	b	c					
GRM21	1.2	4.0	1.65					
		 <p style="text-align: center; margin-top: 5px;">(in mm)</p> <p style="text-align: center; margin-top: 5px;">Fig. 3</p>						
13	Solderability of Termination	75% of the terminations are to be soldered evenly and continuously.	Immerse the capacitor in a solution of ethanol (JIS-K-8101) and rosin (JIS-K-5902) (25% rosin in weight proportion). Preheat at 80 to 120°C for 10 to 30 seconds. After preheating, immerse in eutectic solder solution for 2±0.5 seconds at 230±5°C or Sn-3.0Ag-0.5Cu solder solution for 2±0.5 seconds at 245±5°C.					
14	Resistance to Soldering Heat	Appearance	No defects or abnormalities					
		Capacitance Change	Within ±7.5%					
		D.F.	0.01 max.					
		I.R.	More than 10,000MΩ					
		Dielectric Strength	No failure					
15	Temperature Cycle	Appearance	No defects or abnormalities					
		Capacitance Change	Within ±7.5%					
		D.F.	0.01 max.					
		I.R.	More than 10,000MΩ					
		Dielectric Strength	No failure					
16	Humidity, Steady State	Appearance	No defects or abnormalities					
		Capacitance Change	Within ±12.5%					
		D.F.	0.02 max.					
		I.R.	More than 1,000MΩ					
		Dielectric Strength	No failure					
17	Humidity Load	Appearance	No defects or abnormalities					
		Capacitance Change	Within ±12.5%					
		D.F.	0.02 max.					
		I.R.	More than 500MΩ					
18	High Temperature Load	Appearance	No defects or abnormalities					
		Capacitance Change	Within ±12.5%					
		D.F.	0.02 max.					
		I.R.	More than 1,000MΩ					

Chip Monolithic Ceramic Capacitors



Low ESL LLL/LLA/LLM Series

■ Features (Reversed Geometry Low ESL Type)

1. Low ESL, good for noise reduction for high frequency
2. Small, high cap

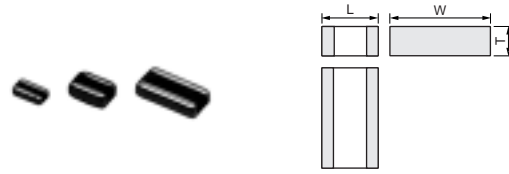

■ Applications

1. High speed microprocessor
2. High frequency digital equipment

Part Number	Dimensions (mm)		
	L	W	T
LLL153	0.5 ±0.05	1.0 ±0.05	0.3 ±0.05
LLL185	0.8 ±0.1	1.6 ±0.1	0.6 max.
LLL215	1.25 ±0.1	2.0 ±0.1	0.5 +0/-0.15
LLL216			0.6 ±0.1
LLL219	1.6 ±0.15	3.2 ±0.15	0.85 ±0.1
LLL315			0.5 +0/-0.15
LLL317			0.7 ±0.1
LLL31M			1.15 ±0.1
LLL31B			1.25 +0.15/-0.05

Reversed Geometry Low ESL Type

Part Number	LLL15				LLL18				LLL21				LLL31						
L x W	0.5x1.0				0.8x1.6				1.25x2.0				1.6x3.2						
TC	X6S (C8)		X7R (R7)		X7S (C7)		X7R (R7)		X7S (C7)		X7R (R7)		X7S (C7)						
Rated Volt.	6.3 (0J)	50 (1H)	25 (1E)	16 (1C)	10 (1A)	6.3 (0J)	4 (0G)	50 (1H)	25 (1E)	16 (1C)	10 (1A)	6.3 (0J)	4 (0G)	50 (1H)	25 (1E)	16 (1C)	10 (1A)	6.3 (0J)	4 (0G)
Capacitance (Capacitance part numbering code) and T (mm) Dimension (T Dimension part numbering code)																			
2200pF (222)	0.5 (5)																		
4700pF (472)	0.5 (5)							0.6 (6)											
10000pF (103)		0.5 (5)						0.6 (6)						0.7 (7)					
22000pF (223)		0.5 (5)						0.6 (6)						0.7 (7)					
47000pF (473)			0.5 (5)					0.6 (6)						0.7 (7)					
0.10μF (104)	0.3 (3)			0.5 (5)				0.6 (6)						1.15 (M)	0.7 (7)				
0.22μF (224)					0.5 (5)				0.85 (9)	0.6 (6)					1.15 (M)	0.7 (7)			
0.47μF (474)						0.5 (5)				0.85 (9)					1.15 (M)	0.7 (7)			
1.0μF (105)							0.5 (5)					0.85 (9)				1.15 (M)	0.7 (7)		
2.2μF (225)								0.5 (5)					0.85 (9)				1.15 (M)	0.7 (7)	
4.7μF (475)																		1.15 (M)	
10μF (106)																			1.25 (B)

The part numbering code is shown in ().

Dimensions are shown in mm and Rated Voltage in Vdc.

Please refer to Specifications and Test Method (2) about LLL15 Series and LLL18 Series 1.0μF/2.2μF type.

Reversed Geometry Low ESL Type Low Profile

Part Number	LLL18				LLL21						LLL31			
L x W	0.8x1.6				1.25x2.0						1.6x3.2			
TC	X7R (R7)		X7S (C7)		X7R (R7)				X7S (C7)		X7R (R7)			
Rated Volt.	25 (1E)	16 (1C)	10 (1A)	4 (0G)	50 (1H)	25 (1E)	16 (1C)	10 (1A)	6.3 (0J)	4 (0G)	50 (1H)	25 (1E)	16 (1C)	10 (1A)
Capacitance (Capacitance part numbering code) and T (mm) Dimension (T Dimension part numbering code)														
1000pF(102)					0.5(5)									
2200pF(222)					0.5(5)									
4700pF(472)					0.5(5)									
10000pF(103)	0.5(5)				0.5(5)						0.5(5)			
22000pF(223)		0.5(5)				0.5(5)					0.5(5)			
47000pF(473)		0.5(5)					0.5(5)					0.5(5)		
0.10μF(104)			0.5(5)				0.5(5)					0.5(5)		
0.22μF(224)				0.5(5)				0.5(5)					0.5(5)	
0.47μF(474)									0.5(5)					0.5(5)
1.0μF(105)										0.5(5)				

The part numbering code is shown in ().
 Dimensions are shown in mm and Rated Voltage in Vdc.

■ Features (Eight Terminals Low ESL Type)

1. Low ESL(100pH), suitable to decoupling capacitor for 1GHz clock speed IC.
2. Small, large cap

■ Applications

1. High speed microprocessor
2. High frequency digital equipment

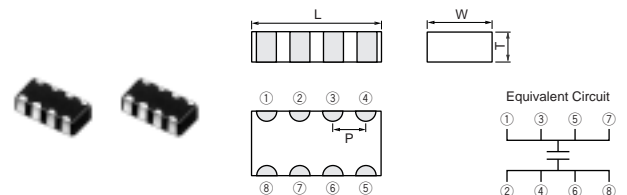

Part Number	Dimensions (mm)			
	L	W	T	P
LLA185	1.6 ±0.1	0.8 ±0.1	0.5 +0.05/-0.1	0.4 ±0.1
LLA215	2.0 ±0.1	1.25 ±0.1	0.5 +0.05/-0.1	0.5 ±0.05
LLA219	2.0 ±0.1	1.25 ±0.1	0.85 ±0.1	0.5 ±0.05
LLA315	3.2 ±0.15	1.6 ±0.15	0.5 +0.05/-0.1	0.8 ±0.1
LLA319	3.2 ±0.15	1.6 ±0.15	0.85 ±0.1	0.8 ±0.1
LLA31M	3.2 ±0.15	1.6 ±0.15	1.15 ±0.1	0.8 ±0.1

Eight Terminals Low ESL Type

Part Number	LLA18	LLA21						LLA31		
L x W	1.6x0.8	2.0x1.25						3.2x1.6		
TC	X7S (C7)	X7R (R7)				X7S (C7)		X7R (R7)		
Rated Volt.	4 (0G)	25 (1E)	16 (1C)	10 (1A)	6.3 (0J)	4 (0G)	16 (1C)	10 (1A)	4 (0G)	
Capacitance (Capacitance part numbering code) and T (mm) Dimension (T Dimension part numbering code)										
10000pF(103)		0.85(9)								
22000pF(223)		0.85(9)								
47000pF(473)		0.85(9)								
0.10μF(104)	0.5(5)		0.85(9)				0.85(9)			
0.22μF(224)	0.5(5)		0.85(9)				0.85(9)			
0.47μF(474)	0.5(5)			0.85(9)			0.85(9)			
1.0μF(105)	0.5(5)				0.85(9)			0.85(9)		
2.2μF(225)	0.5(5)					0.85(9)		1.15(M)	0.85(9)	
4.7μF(475)						0.85(9)				

The part numbering code is shown in ().
 Dimensions are shown in mm and Rated Voltage in Vdc.
 Please refer to Specifications and Test Method (2) about LLA18 Series 1.0μF/2.2μF type and LLA21 Series 4.7μF type.

Eight Terminals Low ESL Type Low Profile

Part Number	LLA21					LLA31		
L x W	2.0x1.25					3.2x1.6		
TC	X7R (R7)				X7S (C7)	X7R (R7)		
Rated Volt.	25 (1E)	16 (1C)	10 (1A)	6.3 (0J)	4 (0G)	16 (1C)	10 (1A)	6.3 (0J)
Capacitance (Capacitance part numbering code) and T (mm) Dimension (T Dimension part numbering code)								
10000pF(103)	0.5(5)							
22000pF(223)	0.5(5)							
47000pF(473)		0.5(5)						
0.10μF(104)		0.5(5)				0.5(5)		
0.22μF(224)			0.5(5)	0.5(5)		0.5(5)		
0.47μF(474)				0.5(5)			0.5(5)	
1.0μF(105)					0.5(5)			0.5(5)
2.2μF(225)					0.5(5)			0.5(5)
4.7μF(475)					0.5(5)			

The part numbering code is shown in ().

Dimensions are shown in mm and Rated Voltage in Vdc.

Please refer to Specifications and Test Method (2) about LLA21 Series (Low Profile) 2.2μF/4.7μF type.

9

■ Features (Ten Terminals Low ESL Type)

1. Low ESL(45pH), suitable to decoupling capacitor for 2GHz clock speed IC.
2. Small, large cap

■ Applications

1. High speed microprocessor
2. High frequency digital equipment

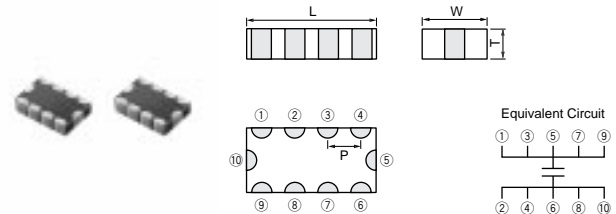

Part Number	Dimensions (mm)			
	L	W	T	P
LLM215	2.0 ±0.1	1.25 ±0.1	0.5 +0.05/-0.1	0.5 ±0.05
LLM315	3.2 ±0.15	1.6 ±0.15	0.5 +0.05/-0.1	0.8 ±0.1

Ten Terminals Low ESL Type Low Profile

Part Number	LLM21					LLM31		
L x W	2.0x1.25					3.2x1.6		
TC	X7R (R7)				X7S (C7)	X7R (R7)		
Rated Volt.	25 (1E)	16 (1C)	6.3 (0J)	4 (0G)	16 (1C)	10 (1A)	6.3 (0J)	
Capacitance (Capacitance part numbering code) and T (mm) Dimension (T Dimension part numbering code)								
10000pF(103)	0.5(5)							
22000pF(223)	0.5(5)							
47000pF(473)		0.5(5)						
0.10μF(104)		0.5(5)				0.5(5)		
0.22μF(224)			0.5(5)			0.5(5)		
0.47μF(474)			0.5(5)				0.5(5)	
1.0μF(105)					0.5(5)			
2.2μF(225)					0.5(5)			0.5(5)

The part numbering code is shown in ().

Dimensions are shown in mm and Rated Voltage in Vdc.

Please refer to Specifications and Test Method (2) about LLM21 Series (Low Profile) 2.2μF type.

LLL/LLA/LLM Series Specifications and Test Methods (1)

No.	Item	Specifications	Test Method												
1	Operating Temperature Range	R7, C7: -55 to +125°C													
2	Rated Voltage	See the previous pages.	The rated voltage is defined as the maximum voltage which may be applied continuously to the capacitor. When AC voltage is superimposed on DC voltage, V^{P-P} or V^{O-P} , whichever is larger, should be maintained within the rated voltage range.												
3	Appearance	No defects or abnormalities	Visual inspection												
4	Dimensions	Within the specified dimension	Using calipers												
5	Dielectric Strength	No defects or abnormalities	No failure should be observed when 250% of the rated voltage is applied between the terminations for 1 to 5 seconds, provided the charge/discharge current is less than 50mA.												
6	Insulation Resistance	More than 10,000MΩ or 500Ω · F (Whichever is smaller)	The insulation resistance should be measured with a DC voltage not exceeding the rated voltage at 25°C and 75%RH max. and within 2 minutes of charging.												
7	Capacitance	Within the specified tolerance	The capacitance/D.F. should be measured at 25°C at the frequency and voltage shown in the table.												
8	Dissipation Factor (D.F.)	W.V.: 25V min.; 0.025 max. W.V.: 16V max.; 0.035 max. *1	<table border="1" style="width: 100%; border-collapse: collapse; text-align: center;"> <thead> <tr> <th>Capacitance</th> <th>Frequency</th> <th>Voltage</th> </tr> </thead> <tbody> <tr> <td>$C \leq 10\mu\text{F}$ (10V min.)</td> <td>$1 \pm 0.1\text{kHz}$</td> <td>$1.0 \pm 0.2\text{Vrms}$</td> </tr> <tr> <td>$C \leq 10\mu\text{F}$ (6.3V max.)</td> <td>$1 \pm 0.1\text{kHz}$</td> <td>$0.5 \pm 0.1\text{Vrms}$</td> </tr> <tr> <td>$C > 10\mu\text{F}$</td> <td>$120 \pm 24\text{Hz}$</td> <td>$0.5 \pm 0.1\text{Vrms}$</td> </tr> </tbody> </table>	Capacitance	Frequency	Voltage	$C \leq 10\mu\text{F}$ (10V min.)	$1 \pm 0.1\text{kHz}$	$1.0 \pm 0.2\text{Vrms}$	$C \leq 10\mu\text{F}$ (6.3V max.)	$1 \pm 0.1\text{kHz}$	$0.5 \pm 0.1\text{Vrms}$	$C > 10\mu\text{F}$	$120 \pm 24\text{Hz}$	$0.5 \pm 0.1\text{Vrms}$
			Capacitance	Frequency	Voltage										
$C \leq 10\mu\text{F}$ (10V min.)	$1 \pm 0.1\text{kHz}$	$1.0 \pm 0.2\text{Vrms}$													
$C \leq 10\mu\text{F}$ (6.3V max.)	$1 \pm 0.1\text{kHz}$	$0.5 \pm 0.1\text{Vrms}$													
$C > 10\mu\text{F}$	$120 \pm 24\text{Hz}$	$0.5 \pm 0.1\text{Vrms}$													
<table border="1" style="width: 100%; border-collapse: collapse; text-align: center;"> <thead> <tr> <th>Step</th> <th>Temperature (°C)</th> </tr> </thead> <tbody> <tr> <td>1</td> <td>25 ± 2</td> </tr> <tr> <td>2</td> <td>-55 ± 3</td> </tr> <tr> <td>3</td> <td>25 ± 2</td> </tr> <tr> <td>4</td> <td>125 ± 3</td> </tr> <tr> <td>5</td> <td>25 ± 2</td> </tr> </tbody> </table>	Step	Temperature (°C)	1	25 ± 2	2	-55 ± 3	3	25 ± 2	4	125 ± 3	5	25 ± 2			
Step	Temperature (°C)														
1	25 ± 2														
2	-55 ± 3														
3	25 ± 2														
4	125 ± 3														
5	25 ± 2														
9	Capacitance Temperature Characteristics	<table border="1" style="width: 100%; border-collapse: collapse; text-align: center;"> <thead> <tr> <th>Char.</th> <th>Temp. Range (°C)</th> <th>Reference Temp.</th> <th>Cap.Change</th> </tr> </thead> <tbody> <tr> <td>R7</td> <td>-55 to +125</td> <td>25°C</td> <td>Within $\pm 15\%$</td> </tr> <tr> <td>C7</td> <td>-55 to +125</td> <td>25°C</td> <td>Within $\pm 22\%$</td> </tr> </tbody> </table>	Char.	Temp. Range (°C)	Reference Temp.	Cap.Change	R7	-55 to +125	25°C	Within $\pm 15\%$	C7	-55 to +125	25°C	Within $\pm 22\%$	<p>The capacitance change should be measured after 5 min. at each specified temperature stage.</p> <p>The ranges of capacitance change compared with the 25°C value over the temperature ranges shown in the table should be within the specified ranges.</p>
Char.	Temp. Range (°C)	Reference Temp.	Cap.Change												
R7	-55 to +125	25°C	Within $\pm 15\%$												
C7	-55 to +125	25°C	Within $\pm 22\%$												
10	Adhesive Strength of Termination	No removal of the terminations or other defect should occur.	Solder the capacitor to the test jig (glass epoxy board) using a eutectic solder. Then apply 10N* force in parallel with the test jig for 10±1 sec. The soldering should be done either with an iron or using the reflow method and should be conducted with care so that the soldering is uniform and free of defects such as heat shock. *LLL18 and LLA/LLM Series: 5N												
11	Vibration Resistance	Appearance	No defects or abnormalities												
		Capacitance	Within the specified tolerance												
		D.F.	W.V.: 25V min.; 0.025 max. W.V.: 16V max.; 0.035 max. *1												
12	Solderability of Termination	75% of the terminations are to be soldered evenly and continuously.	Immerse the capacitor in a solution of ethanol (JIS-K-8101) and rosin (JIS-K-5902) (25% rosin in weight proportion). Preheat at 80 to 120°C for 10 to 30 seconds. After preheating, immerse in eutectic solder solution for 2±0.5 seconds at 230±5°C, or Sn-3.0Ag-0.5Cu solder solution for 2±0.5 seconds at 245±5°C.												
13	Resistance to Soldering Heat	Appearance	No marking defects												
		Capacitance Change	Within $\pm 7.5\%$												
		D.F.	W.V.: 25V min.; 0.025 max. W.V.: 16V max.; 0.035 max. *1												
		I.R.	More than 10,000MΩ or 500Ω · F (Whichever is smaller)												
		Dielectric Strength	No failure												
			<p>Preheat the capacitor at 120 to 150°C for 1 minute. Immerse the capacitor in a eutectic solder or Sn-3.0Ag-0.5Cu solder solution at 270±5°C for 10±0.5 seconds. Let sit at room temperature for 24±2 hours, then measure.</p> <p>• Initial measurement. Perform a heat treatment at 150±5°C for one hour and then let sit for 24±2 hours at room temperature. Perform the initial measurement.</p>												

Continued on the following page.

LLL/LLA/LLM Series Specifications and Test Methods (1)

Continued from the preceding page.

No.	Item	Specifications	Test Method															
14	Temperature Cycle	Appearance	Fix the capacitor to the supporting jig in the same manner and under the same conditions as (10). Perform the five cycles according to the four heat treatments listed in the following table. Let sit for 24±2 hours at room temperature, then measure. <table border="1" style="margin-top: 10px;"> <thead> <tr> <th>Step</th> <th>1</th> <th>2</th> <th>3</th> <th>4</th> </tr> </thead> <tbody> <tr> <td>Temp. (°C)</td> <td>Min. Operating Temp. ± 3</td> <td>Room Temp.</td> <td>Max. Operating Temp. ± 3</td> <td>Room Temp.</td> </tr> <tr> <td>Time (min.)</td> <td>30±3</td> <td>2 to 3</td> <td>30±3</td> <td>2 to 3</td> </tr> </tbody> </table>	Step	1	2	3	4	Temp. (°C)	Min. Operating Temp. ± 3	Room Temp.	Max. Operating Temp. ± 3	Room Temp.	Time (min.)	30±3	2 to 3	30±3	2 to 3
		Step		1	2	3	4											
		Temp. (°C)		Min. Operating Temp. ± 3	Room Temp.	Max. Operating Temp. ± 3	Room Temp.											
		Time (min.)		30±3	2 to 3	30±3	2 to 3											
		Capacitance Change		Within ±7.5% *1														
D.F.	W.V.: 25V min.; 0.025 max. W.V.: 16V max.; 0.035 max. *1																	
I.R.	More than 10,000MΩ or 500Ω · F (Whichever is smaller)																	
	Dielectric Strength	No failure	• Initial measurement. Perform a heat treatment at 150±9 ₀ °C for one hour and then let sit for 24±2 hours at room temperature. Perform the initial measurement.															
15	Humidity (Steady State)	Appearance	Sit the capacitor at 40±2°C and 90 to 95% humidity for 500±12 hours. Remove and let sit for 24±2 hours at room temperature, then measure.															
		Capacitance Change		Within ±12.5% *1														
		D.F.		0.05 max. *1														
		I.R.		More than 1,000MΩ or 50Ω · F (Whichever is smaller)														
16	Humidity Load	Appearance	Apply the rated voltage at 40±2°C and 90 to 95% humidity for 500±12 hours. Remove and let sit for 24±2 hours at room temperature, then measure. The charge/discharge current is less than 50mA.															
		Capacitance Change		Within ±12.5% *1														
		D.F.		0.05 max. *1														
		I.R.		More than 500MΩ or 25Ω · F *1 (Whichever is smaller)														
		Dielectric Strength		No failure														
17	High Temperature Load	Appearance	Apply 200% of the rated voltage for 1000±12 hours at the maximum operating temperature ±3°C. Let sit for 24±2 hours at room temperature, then measure. The charge/discharge current is less than 50mA. •Initial measurement. Apply 200% of the rated DC voltage for one hour at the maximum operating temperature ±3°C. Remove and let sit for 24±2 hours at room temperature. Perform initial measurement. (*1)															
		Capacitance Change		Within ±12.5% *1														
		D.F.		W.V.: 25V min.; 0.04 max. W.V.: 16V max.; 0.05 max. *1														
		I.R.		More than 1,000MΩ or 50Ω · F *1 (Whichever is smaller)														
		Dielectric Strength		No failure														

*1: The figure indicates typical inspection. Please refer to individual specifications.

LLL/LLA/LLM Series Specifications and Test Methods (2)

No.	Item	Specifications	Test Method														
1	Operating Temperature Range	R7, C7: -55 to +125°C C8: -55 to +105°C															
2	Rated Voltage	See the previous pages.	The rated voltage is defined as the maximum voltage which may be applied continuously to the capacitor. When AC voltage is superimposed on DC voltage, V^{P-P} or V^{O-P} , whichever is larger, should be maintained within the rated voltage range.														
3	Appearance	No defects or abnormalities	Visual inspection														
4	Dimensions	Within the specified dimension	Using calipers														
5	Dielectric Strength	No defects or abnormalities	No failure should be observed when 250% of the rated voltage is applied between the terminations for 1 to 5 seconds, provided the charge/discharge current is less than 50mA.														
6	Insulation Resistance	50Ω · F min.	The insulation resistance should be measured with a DC voltage not exceeding the rated voltage at 25°C and 75%RH max. and within 1 minute of charging.														
7	Capacitance	Within the specified tolerance	The capacitance/D.F. should be measured at 25°C at the frequency and voltage shown in the table.														
8	Dissipation Factor (D.F.)	R7, C7, C8: 0.120 max.	<table border="1" style="margin-left: auto; margin-right: auto;"> <thead> <tr> <th>Capacitance</th> <th>Frequency</th> <th>Voltage</th> </tr> </thead> <tbody> <tr> <td>C≤10μF (10V min.)</td> <td>1±0.1kHz</td> <td>1.0±0.2Vrms</td> </tr> <tr> <td>C≤10μF (6.3V max.)</td> <td>1±0.1kHz</td> <td>0.5±0.1Vrms</td> </tr> <tr> <td>C>10μF</td> <td>120±24Hz</td> <td>0.5±0.1Vrms</td> </tr> </tbody> </table>	Capacitance	Frequency	Voltage	C≤10μF (10V min.)	1±0.1kHz	1.0±0.2Vrms	C≤10μF (6.3V max.)	1±0.1kHz	0.5±0.1Vrms	C>10μF	120±24Hz	0.5±0.1Vrms		
Capacitance	Frequency	Voltage															
C≤10μF (10V min.)	1±0.1kHz	1.0±0.2Vrms															
C≤10μF (6.3V max.)	1±0.1kHz	0.5±0.1Vrms															
C>10μF	120±24Hz	0.5±0.1Vrms															
9	Capacitance Temperature Characteristics	<table border="1" style="margin-left: auto; margin-right: auto;"> <thead> <tr> <th>Char.</th> <th>Temp. Range (°C)</th> <th>Reference Temp.</th> <th>Cap.Change</th> </tr> </thead> <tbody> <tr> <td>R7</td> <td>-55 to +125</td> <td rowspan="3" style="text-align: center;">25°C</td> <td>Within ±15%</td> </tr> <tr> <td>C7</td> <td>-55 to +125</td> <td>Within ±22%</td> </tr> <tr> <td>C8</td> <td>-55 to +105</td> <td>Within ±22%</td> </tr> </tbody> </table>	Char.	Temp. Range (°C)	Reference Temp.	Cap.Change	R7	-55 to +125	25°C	Within ±15%	C7	-55 to +125	Within ±22%	C8	-55 to +105	Within ±22%	The capacitance change should be measured after 5 min. at each specified temperature stage. The ranges of capacitance change compared with the 25°C value over the temperature ranges shown in the table should be within the specified ranges.
Char.	Temp. Range (°C)	Reference Temp.	Cap.Change														
R7	-55 to +125	25°C	Within ±15%														
C7	-55 to +125		Within ±22%														
C8	-55 to +105		Within ±22%														
10	Adhesive Strength of Termination	No removal of the terminations or other defect should occur.	Solder the capacitor to the test jig (glass epoxy board) using a eutectic solder. Then apply 10N* force in parallel with the test jig for 10±1 sec. The soldering should be done either with an iron or using the reflow method and should be conducted with care so that the soldering is uniform and free of defects such as heat shock. *5N (LLL15, LLL18, LLA, LLM Series)														
11	Vibration	Appearance	No defects or abnormalities														
		Capacitance	Within the specified tolerance														
		D.F.	R7, C7, C8: 0.120 max.														
12	Solderability of Termination	75% of the terminations are to be soldered evenly and continuously.	Immerse the capacitor in a solution of ethanol (JIS-K-8101) and rosin (JIS-K-5902) (25% rosin in weight proportion). Preheat at 80 to 120°C for 10 to 30 seconds. After preheating, immerse in eutectic solder solution for 2±0.5 seconds at 230±5°C, or Sn-3.0Ag-0.5Cu solder solution for 2±0.5 seconds at 245±5°C.														
13	Resistance to Soldering Heat	Appearance	No marking defects														
		Capacitance Change	R7, C7, C8: Within ±7.5%														
		D.F.	R7, C7, C8: 0.120 max.														
		I.R.	50Ω · F min.														
		Dielectric Strength	No failure														
			Preheat the capacitor at 120 to 150°C for 1 minute. Immerse the capacitor in a eutectic solder or Sn-3.0Ag-0.5Cu solder solution at 270±5°C for 10±0.5 seconds. Let sit at room temperature for 24±2 hours, then measure. • Initial measurement. Perform a heat treatment at 150±5°C for one hour and then let sit for 24±2 hours at room temperature. Perform the initial measurement.														

Continued on the following page.

LLL/LLA/LLM Series Specifications and Test Methods (2)

Continued from the preceding page.

No.	Item	Specifications	Test Method															
14	Temperature Sudden Change	Appearance	No marking defects															
		Capacitance Change	R7, C7, C8: Within $\pm 12.5\%$															
		D.F.	R7, C7, C8: 0.120 max.															
		I.R.	50 Ω · F min.															
		Dielectric Strength	No failure															
			<p>Fix the capacitor to the supporting jig in the same manner and under the same conditions as (10). Perform the five cycles according to the four heat treatments listed in the following table. Let sit for 24\pm2 hours at room temperature, then measure.</p> <table border="1"> <thead> <tr> <th>Step</th> <th>1</th> <th>2</th> <th>3</th> <th>4</th> </tr> </thead> <tbody> <tr> <td>Temp. (°C)</td> <td>Min. Operating Temp. ± 3</td> <td>Room Temp.</td> <td>Max. Operating Temp. ± 3</td> <td>Room Temp.</td> </tr> <tr> <td>Time (min.)</td> <td>30\pm3</td> <td>2 to 3</td> <td>30\pm3</td> <td>2 to 3</td> </tr> </tbody> </table> <p>• Initial measurement Perform a heat treatment at 150\pm9$^{\circ}$C for one hour and then let sit for 24\pm2 hours at room temperature. Perform the initial measurement.</p>	Step	1	2	3	4	Temp. (°C)	Min. Operating Temp. ± 3	Room Temp.	Max. Operating Temp. ± 3	Room Temp.	Time (min.)	30 \pm 3	2 to 3	30 \pm 3	2 to 3
Step	1	2	3	4														
Temp. (°C)	Min. Operating Temp. ± 3	Room Temp.	Max. Operating Temp. ± 3	Room Temp.														
Time (min.)	30 \pm 3	2 to 3	30 \pm 3	2 to 3														
15	High Temperature High Humidity (Steady State)	Appearance	No marking defects															
		Capacitance Change	R7, C7, C8: Within $\pm 12.5\%$															
		D.F.	R7, C7, C8: 0.2 max.															
		I.R.	12.5 Ω · F min.															
			<p>Apply the rated voltage at 40\pm2$^{\circ}$C and 90 to 95% humidity for 500\pm12 hours. The charge/discharge current is less than 50mA.</p> <p>• Initial measurement Perform a heat treatment at 150\pm9$^{\circ}$C for one hour and then let sit for 24\pm2 hours at room temperature. Perform the initial measurement.</p> <p>• Measurement after test Perform a heat treatment at 150\pm9$^{\circ}$C for one hour and then let sit for 24\pm2 hours at room temperature, then measure.</p>															
16	Durability	Appearance	No marking defects															
		Capacitance Change	R7, C7, C8: Within $\pm 12.5\%$															
		D.F.	R7, C7, C8: 0.2 max.															
		I.R.	25 Ω · F min.															
			<p>Apply 150% of the rated voltage for 1000\pm12 hours at the maximum operating temperature $\pm 3^{\circ}$C. The charge/discharge current is less than 50mA.</p> <p>• Initial measurement Perform a heat treatment at 150\pm9$^{\circ}$C for one hour and then let sit for 24\pm2 hours at room temperature. Perform the initial measurement.</p> <p>• Measurement after test Perform a heat treatment at 150\pm9$^{\circ}$C for one hour and then let sit for 24\pm2 hours at room temperature, then measure.</p>															

Chip Monolithic Ceramic Capacitors



High-Q GJM Series

■ Features

1. Mobile telecommunications and RF module, mainly
2. Quality improvement of telephone call, low power consumption, yield ratio improvement

■ Applications

VCO, PA, Mobile telecommunications

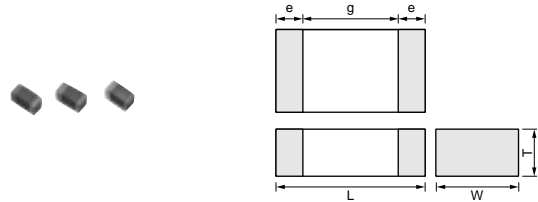

Part Number	Dimensions (mm)				
	L	W	T	e	g min.
GJM03	0.6 ±0.03	0.3 ±0.03	0.3 ±0.03	0.1 to 0.2	0.2
GJM15	1.0 ±0.05	0.5 ±0.05	0.5 ±0.05	0.15 to 0.3	0.4

Part Number	GJM03	GJM15
L x W [EIA]	0.6x0.3 [0201]	1.0x0.5 [0402]
TC	COG (5C)	COG (5C)
Rated Volt.	25 (1E)	50 (1H)
Capacitance (Capacitance part numbering code) and T (mm) Dimension (T Dimension part numbering code)		
0.20pF(R20)	0.3(3)	
0.30pF(R30)	0.3(3)	0.5(5)
0.40pF(R40)	0.3(3)	0.5(5)
0.50pF(R50)	0.3(3)	0.5(5)
0.60pF(R60)	0.3(3)	0.5(5)
0.70pF(R70)	0.3(3)	0.5(5)
0.75pF(R75)	0.3(3)	0.5(5)
0.80pF(R80)	0.3(3)	0.5(5)
0.90pF(R90)	0.3(3)	0.5(5)
1.0pF(1R0)	0.3(3)	0.5(5)
1.1pF(1R1)	0.3(3)	0.5(5)
1.2pF(1R2)	0.3(3)	0.5(5)
1.3pF(1R3)	0.3(3)	0.5(5)
1.4pF(1R4)	0.3(3)	0.5(5)
1.5pF(1R5)	0.3(3)	0.5(5)
1.6pF(1R6)	0.3(3)	0.5(5)
1.7pF(1R7)	0.3(3)	0.5(5)
1.8pF(1R8)	0.3(3)	0.5(5)
1.9pF(1R9)	0.3(3)	0.5(5)
2.0pF(2R0)	0.3(3)	0.5(5)
2.1pF(2R1)	0.3(3)	0.5(5)
2.2pF(2R2)	0.3(3)	0.5(5)
2.3pF(2R3)	0.3(3)	0.5(5)
2.4pF(2R4)	0.3(3)	0.5(5)
2.5pF(2R5)	0.3(3)	0.5(5)
2.6pF(2R6)	0.3(3)	0.5(5)
2.7pF(2R7)	0.3(3)	0.5(5)
2.8pF(2R8)	0.3(3)	0.5(5)
2.9pF(2R9)	0.3(3)	0.5(5)
3.0pF(3R0)	0.3(3)	0.5(5)
3.1pF(3R1)	0.3(3)	0.5(5)
3.2pF(3R2)	0.3(3)	0.5(5)
3.3pF(3R3)	0.3(3)	0.5(5)

10

Continued on the following page.

 Continued from the preceding page.

Part Number	GJM03	GJM15
L x W [EIA]	0.6x0.3 [0201]	1.0x0.5 [0402]
TC	COG (5C)	COG (5C)
Rated Volt.	25 (1E)	50 (1H)
Capacitance (Capacitance part numbering code) and T (mm) Dimension (T Dimension part numbering code)		
3.4pF(3R4)	0.3(3)	0.5(5)
3.5pF(3R5)	0.3(3)	0.5(5)
3.6pF(3R6)	0.3(3)	0.5(5)
3.7pF(3R7)	0.3(3)	0.5(5)
3.8pF(3R8)	0.3(3)	0.5(5)
3.9pF(3R9)	0.3(3)	0.5(5)
4.0pF(4R0)	0.3(3)	0.5(5)
4.1pF(4R1)	0.3(3)	0.5(5)
4.2pF(4R2)	0.3(3)	0.5(5)
4.3pF(4R3)	0.3(3)	0.5(5)
4.4pF(4R4)	0.3(3)	0.5(5)
4.5pF(4R5)	0.3(3)	0.5(5)
4.6pF(4R6)	0.3(3)	0.5(5)
4.7pF(4R7)	0.3(3)	0.5(5)
4.8pF(4R8)	0.3(3)	0.5(5)
4.9pF(4R9)	0.3(3)	0.5(5)
5.0pF(5R0)	0.3(3)	0.5(5)
5.1pF(5R1)	0.3(3)	0.5(5)
5.2pF(5R2)	0.3(3)	0.5(5)
5.3pF(5R3)	0.3(3)	0.5(5)
5.4pF(5R4)	0.3(3)	0.5(5)
5.5pF(5R5)	0.3(3)	0.5(5)
5.6pF(5R6)	0.3(3)	0.5(5)
5.7pF(5R7)	0.3(3)	0.5(5)
5.8pF(5R8)	0.3(3)	0.5(5)
5.9pF(5R9)	0.3(3)	0.5(5)
6.0pF(6R0)	0.3(3)	0.5(5)
6.1pF(6R1)	0.3(3)	0.5(5)
6.2pF(6R2)	0.3(3)	0.5(5)
6.3pF(6R3)	0.3(3)	0.5(5)
6.4pF(6R4)	0.3(3)	0.5(5)
6.5pF(6R5)	0.3(3)	0.5(5)
6.6pF(6R6)	0.3(3)	0.5(5)
6.7pF(6R7)	0.3(3)	0.5(5)
6.8pF(6R8)	0.3(3)	0.5(5)
6.9pF(6R9)		0.5(5)
7.0pF(7R0)		0.5(5)
7.1pF(7R1)		0.5(5)
7.2pF(7R2)		0.5(5)
7.3pF(7R3)		0.5(5)
7.4pF(7R4)		0.5(5)
7.5pF(7R5)		0.5(5)
7.6pF(7R6)		0.5(5)
7.7pF(7R7)		0.5(5)
7.8pF(7R8)		0.5(5)
7.9pF(7R9)		0.5(5)
8.0pF(8R0)		0.5(5)
8.1pF(8R1)		0.5(5)
8.2pF(8R2)		0.5(5)
8.3pF(8R3)		0.5(5)
8.4pF(8R4)		0.5(5)
8.5pF(8R5)		0.5(5)

Continued on the following page. 

Continued from the preceding page.

Part Number	GJM03	GJM15
L x W [EIA]	0.6x0.3 [0201]	1.0x0.5 [0402]
TC	COG (5C)	COG (5C)
Rated Volt.	25 (1E)	50 (1H)
Capacitance (Capacitance part numbering code) and T (mm) Dimension (T Dimension part numbering code)		
8.6pF(8R6)		0.5(5)
8.7pF(8R7)		0.5(5)
8.8pF(8R8)		0.5(5)
8.9pF(8R9)		0.5(5)
9.0pF(9R0)		0.5(5)
9.1pF(9R1)		0.5(5)
9.2pF(9R2)		0.5(5)
9.3pF(9R3)		0.5(5)
9.4pF(9R4)		0.5(5)
9.5pF(9R5)		0.5(5)
9.6pF(9R6)		0.5(5)
9.7pF(9R7)		0.5(5)
9.8pF(9R8)		0.5(5)
9.9pF(9R9)		0.5(5)
10pF(100)		0.5(5)
12pF(120)		0.5(5)
15pF(150)		0.5(5)
18pF(180)		0.5(5)

The part numbering code is shown in ().
 Dimensions are shown in mm and Rated Voltage in Vdc.

Chip Monolithic Ceramic Capacitors



Tight Tolerance High-Q GJM Series

■ Features

1. Mobile telecommunications and RF module, mainly
2. Quality improvement of telephone call, low power consumption, yield ratio improvement

■ Applications

VCO, PA, Mobile telecommunications

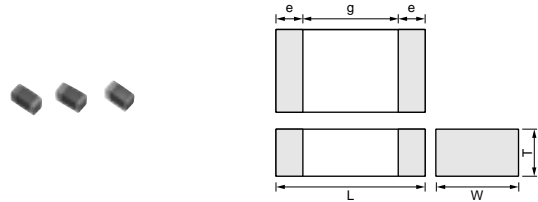

Part Number	Dimensions (mm)				
	L	W	T	e	g min.
GJM03	0.6 ±0.03	0.3 ±0.03	0.3 ±0.03	0.1 to 0.2	0.2
GJM15	1.0 ±0.05	0.5 ±0.05	0.5 ±0.05	0.15 to 0.3	0.4

Part Number	GJM03	GJM15
L x W [EIA]	0.6x0.3 [0201]	1.0x0.5 [0402]
TC	COG (5C)	COG (5C)
Rated Volt.	25 (1E)	50 (1H)

Capacitance, Capacitance Tolerance and T Dimension		
0.10pF(R10)	W, B	0.5(5)
0.20pF(R20)	W, B	0.3(3)
0.30pF(R30)	W, B	0.3(3)
0.40pF(R40)	W, B	0.3(3)
0.50pF(R50)	W, B	0.3(3)
0.60pF(R60)	W, B	0.3(3)
0.70pF(R70)	W, B	0.3(3)
0.80pF(R80)	W, B	0.3(3)
0.90pF(R90)	W, B	0.3(3)
1.0pF(1R0)	W, B	0.3(3)
1.1pF(1R1)	W, B	0.3(3)
1.2pF(1R2)	W, B	0.3(3)
1.3pF(1R3)	W, B	0.3(3)
1.4pF(1R4)	W, B	0.3(3)
1.5pF(1R5)	W, B	0.3(3)
1.6pF(1R6)	W, B	0.3(3)
1.7pF(1R7)	W, B	0.3(3)
1.8pF(1R8)	W, B	0.3(3)
1.9pF(1R9)	W, B	0.3(3)
2.0pF(2R0)	W, B	0.3(3)
2.1pF(2R1)	W, B	0.3(3)
2.2pF(2R2)	W, B	0.3(3)
2.3pF(2R3)	W, B	0.3(3)
2.4pF(2R4)	W, B	0.3(3)
2.5pF(2R5)	W, B	0.3(3)
2.6pF(2R6)	W, B	0.3(3)
2.7pF(2R7)	W, B	0.3(3)
2.8pF(2R8)	W, B	0.3(3)
2.9pF(2R9)	W, B	0.3(3)
3.0pF(3R0)	W, B	0.3(3)
3.1pF(3R1)	W, B	0.3(3)
3.2pF(3R2)	W, B	0.3(3)
3.3pF(3R3)	W, B	0.3(3)

Continued on the following page.

 Continued from the preceding page.

Part Number	GJM03		GJM15	
L x W [EIA]	0.6x0.3 [0201]		1.0x0.5 [0402]	
TC	COG (5C)		COG (5C)	
Rated Volt.	25 (1E)		50 (1H)	
Capacitance, Capacitance Tolerance and T Dimension				
3.4pF(3R4)	W, B	0.3(3)	0.5(5)	
3.5pF(3R5)	W, B	0.3(3)	0.5(5)	
3.6pF(3R6)	W, B	0.3(3)	0.5(5)	
3.7pF(3R7)	W, B	0.3(3)	0.5(5)	
3.8pF(3R8)	W, B	0.3(3)	0.5(5)	
3.9pF(3R9)	W, B	0.3(3)	0.5(5)	
4.0pF(4R0)	W, B	0.3(3)	0.5(5)	
4.1pF(4R1)	W, B	0.3(3)	0.5(5)	
4.2pF(4R2)	W, B	0.3(3)	0.5(5)	
4.3pF(4R3)	W, B	0.3(3)	0.5(5)	
4.4pF(4R4)	W, B	0.3(3)	0.5(5)	
4.5pF(4R5)	W, B	0.3(3)	0.5(5)	
4.6pF(4R6)	W, B	0.3(3)	0.5(5)	
4.7pF(4R7)	W, B	0.3(3)	0.5(5)	
4.8pF(4R8)	W, B	0.3(3)	0.5(5)	
4.9pF(4R9)	W, B	0.3(3)	0.5(5)	
5.0pF(5R0)	W, B	0.3(3)	0.5(5)	
5.1pF(5R1)	W, B, C	0.3(3)	0.5(5)	
5.2pF(5R2)	W, B, C	0.3(3)	0.5(5)	
5.3pF(5R3)	W, B, C	0.3(3)	0.5(5)	
5.4pF(5R4)	W, B, C	0.3(3)	0.5(5)	
5.5pF(5R5)	W, B, C	0.3(3)	0.5(5)	
5.6pF(5R6)	W, B, C	0.3(3)	0.5(5)	
5.7pF(5R7)	W, B, C	0.3(3)	0.5(5)	
5.8pF(5R8)	W, B, C	0.3(3)	0.5(5)	
5.9pF(5R9)	W, B, C	0.3(3)	0.5(5)	
6.0pF(6R0)	W, B, C	0.3(3)	0.5(5)	
6.1pF(6R1)	W, B, C	0.3(3)	0.5(5)	
6.2pF(6R2)	W, B, C	0.3(3)	0.5(5)	
6.3pF(6R3)	W, B, C	0.3(3)	0.5(5)	
6.4pF(6R4)	W, B, C	0.3(3)	0.5(5)	
6.5pF(6R5)	W, B, C	0.3(3)	0.5(5)	
6.6pF(6R6)	W, B, C	0.3(3)	0.5(5)	
6.7pF(6R7)	W, B, C	0.3(3)	0.5(5)	
6.8pF(6R8)	W, B, C	0.3(3)	0.5(5)	
6.9pF(6R9)	W, B, C		0.5(5)	
7.0pF(7R0)	W, B, C		0.5(5)	
7.1pF(7R1)	W, B, C		0.5(5)	
7.2pF(7R2)	W, B, C		0.5(5)	
7.3pF(7R3)	W, B, C		0.5(5)	
7.4pF(7R4)	W, B, C		0.5(5)	
7.5pF(7R5)	W, B, C		0.5(5)	
7.6pF(7R6)	W, B, C		0.5(5)	
7.7pF(7R7)	W, B, C		0.5(5)	
7.8pF(7R8)	W, B, C		0.5(5)	
7.9pF(7R9)	W, B, C		0.5(5)	
8.0pF(8R0)	W, B, C		0.5(5)	
8.1pF(8R1)	W, B, C		0.5(5)	
8.2pF(8R2)	W, B, C		0.5(5)	
8.3pF(8R3)	W, B, C		0.5(5)	
8.4pF(8R4)	W, B, C		0.5(5)	
8.5pF(8R5)	W, B, C		0.5(5)	

Continued on the following page. 

 Continued from the preceding page.

Part Number	GJM03		GJM15	
L x W [EIA]	0.6x0.3 [0201]		1.0x0.5 [0402]	
TC	COG (5C)		COG (5C)	
Rated Volt.	25 (1E)		50 (1H)	
Capacitance, Capacitance Tolerance and T Dimension				
8.6pF(8R6)	W, B, C		0.5(5)	
8.7pF(8R7)	W, B, C		0.5(5)	
8.8pF(8R8)	W, B, C		0.5(5)	
8.9pF(8R9)	W, B, C		0.5(5)	
9.0pF(9R0)	W, B, C		0.5(5)	
9.1pF(9R1)	W, B, C		0.5(5)	
9.2pF(9R2)	W, B, C		0.5(5)	
9.3pF(9R3)	W, B, C		0.5(5)	
9.4pF(9R4)	W, B, C		0.5(5)	
9.5pF(9R5)	W, B, C		0.5(5)	
9.6pF(9R6)	W, B, C		0.5(5)	
9.7pF(9R7)	W, B, C		0.5(5)	
9.8pF(9R8)	W, B, C		0.5(5)	
9.9pF(9R9)	W, B, C		0.5(5)	

The part numbering code is shown in ().
 Dimensions are shown in mm and Rated Voltage in Vdc.

Specifications and Test Methods

No.	Item	Specifications		Test Method												
		Temperature Compensating Type														
1	Operating Temperature Range	-55 to +125°C		Reference Temperature: 25°C (2C, 3C, 4C: 20°C)												
2	Rated Voltage	See the previous pages.		The rated voltage is defined as the maximum voltage which may be applied continuously to the capacitor. When AC voltage is superimposed on DC voltage, V^{P-P} or V^{O-P} , whichever is larger, should be maintained within the rated voltage range.												
3	Appearance	No defects or abnormalities		Visual inspection												
4	Dimensions	Within the specified dimensions		Using calipers												
5	Dielectric Strength	No defects or abnormalities		No failure should be observed when 300% of the rated voltage is applied between the terminations for 1 to 5 seconds, provided the charge/discharge current is less than 50mA.												
6	Insulation Resistance (I.R.)	10,000MΩ min. or 500Ω · F min. (Whichever is smaller)		The insulation resistance should be measured with a DC voltage not exceeding the rated voltage at 25°C and 75%RH max. and within 2 minutes of charging.												
7	Capacitance	Within the specified tolerance		The capacitance/Q should be measured at 25°C at the frequency and voltage shown in the table.												
8	Q	30pF max.: $Q \geq 400 + 20C$ C: Nominal Capacitance (pF)														
9	Capacitance Temperature Characteristics	Capacitance Change	Within the specified tolerance (Table A)	The capacitance change should be measured after 5 min. at each specified temperature stage. Temperature Compensating Type The temperature coefficient is determined using the capacitance measured in step 3 as a reference. When cycling the temperature sequentially from step 1 through 5, (5C: +25 to 125°C; other temp. coeffs.: +20 to 125°C) the capacitance should be within the specified tolerance for the temperature coefficient and capacitance change as Table A. The capacitance drift is calculated by dividing the differences between the maximum and minimum measured values in steps 1, 3 and 5 by the capacitance value in step 3.												
		Temperature Coefficient	Within the specified tolerance (Table A)													
		Capacitance Drift	Within $\pm 0.2\%$ or $\pm 0.05\text{pF}$ (Whichever is larger.)													
10	Adhesive Strength of Termination	No removal of the terminations or other defect should occur.		<p>Solder the capacitor to the test jig (glass epoxy board) shown in Fig. 1 using a eutectic solder. Then apply a 5N* force in parallel with the test jig for 10 ± 1 sec. The soldering should be done either with an iron or using the reflow method and should be conducted with care so that the soldering is uniform and free of defects such as heat shock.</p> <p style="text-align: right;">*2N (GJM03)</p>  <table border="1" style="margin-left: auto; margin-right: auto;"> <thead> <tr> <th>Type</th> <th>a</th> <th>b</th> <th>c</th> </tr> </thead> <tbody> <tr> <td>GJM03</td> <td>0.3</td> <td>0.9</td> <td>0.3</td> </tr> <tr> <td>GJM15</td> <td>0.4</td> <td>1.5</td> <td>0.5</td> </tr> </tbody> </table> <p style="text-align: right;">(in mm)</p>	Type	a	b	c	GJM03	0.3	0.9	0.3	GJM15	0.4	1.5	0.5
Type	a	b	c													
GJM03	0.3	0.9	0.3													
GJM15	0.4	1.5	0.5													

Fig. 1

Continued on the following page.

Specifications and Test Methods

Continued from the preceding page.

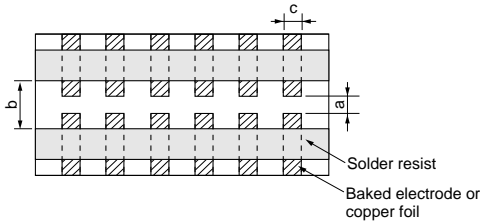
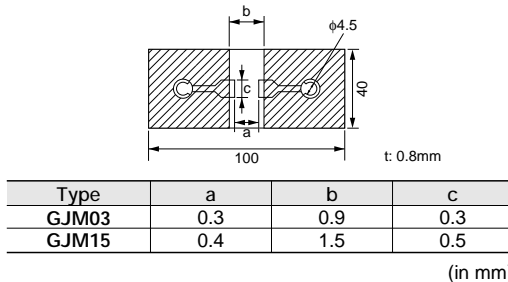
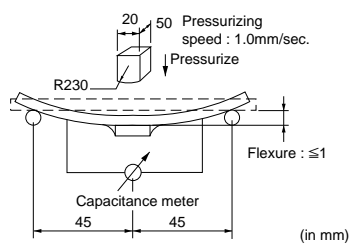
No.	Item	Specifications		Test Method															
		Temperature Compensating Type																	
11	Vibration Resistance	Appearance	No defects or abnormalities	Solder the capacitor to the test jig (glass epoxy board) in the same manner and under the same conditions as (10). The capacitor should be subjected to a simple harmonic motion having a total amplitude of 1.5mm, the frequency being varied uniformly between the approximate limits of 10 and 55Hz. The frequency range, from 10 to 55Hz and return to 10Hz, should be traversed in approximately 1 minute. This motion should be applied for a period of 2 hours in each of 3 mutually perpendicular directions (total of 6 hours).															
		Capacitance	Within the specified tolerance																
		Q	$Q \geq 400 + 20C$ C: Nominal Capacitance (pF)																
12	Deflection	No cracking or marking defects should occur.		Solder the capacitor to the test jig (glass epoxy boards) shown in Fig. 2 using a eutectic solder. Then apply a force in the direction shown in Fig. 3. The soldering should be done by the reflow method and should be conducted with care so that the soldering is uniform and free of defects such as heat shock.															
		 <table border="1" data-bbox="367 862 877 929"> <thead> <tr> <th>Type</th> <th>a</th> <th>b</th> <th>c</th> </tr> </thead> <tbody> <tr> <td>GJM03</td> <td>0.3</td> <td>0.9</td> <td>0.3</td> </tr> <tr> <td>GJM15</td> <td>0.4</td> <td>1.5</td> <td>0.5</td> </tr> </tbody> </table> <p style="text-align: center;">(in mm)</p>			Type	a	b	c	GJM03	0.3	0.9	0.3	GJM15	0.4	1.5	0.5			
Type	a	b	c																
GJM03	0.3	0.9	0.3																
GJM15	0.4	1.5	0.5																
		 <p style="text-align: center;">(in mm)</p>																	
13	Solderability of Termination	75% of the terminations are to be soldered evenly and continuously.		Immerse the capacitor in a solution of ethanol (JIS-K-8101) and rosin (JIS-K-5902) (25% rosin in weight proportion). Preheat at 80 to 120°C for 10 to 30 seconds. After preheating, immerse in eutectic solder solution for 2±0.5 seconds at 230±5°C or Sn-3.0Ag-0.5Cu solder solution for 2±0.5 seconds at 245±5°C.															
14	Resistance to Soldering Heat	The measured and observed characteristics should satisfy the specifications in the following table.		Preheat the capacitor at 120 to 150°C for 1 minute. Immerse the capacitor in a eutectic solder or Sn-3.0Ag-0.5Cu solder solution at 270±5°C for 10±0.5 seconds. Let sit at room temperature for 24±2 hours.															
		Appearance	No marking defects																
		Capacitance Change	Within ±2.5% or ±0.25pF (Whichever is larger)																
		Q	$Q \geq 400 + 20C$ C: Nominal Capacitance (pF)																
		I.R.	More than 10,000MΩ or 500Ω · F (Whichever is smaller)																
	Dielectric Strength	No failure																	
15	Temperature Cycle	The measured and observed characteristics should satisfy the specifications in the following table.		Fix the capacitor to the supporting jig in the same manner and under the same conditions as (10). Perform the five cycles according to the four heat treatments listed in the following table. Let sit for 24±2 hours at room temperature, then measure.															
		Appearance	No marking defects																
		Capacitance Change	Within ±2.5% or ±0.25pF (Whichever is larger)																
		Q	$Q \geq 400 + 20C$ C: Nominal Capacitance (pF)																
		I.R.	More than 10,000MΩ or 500Ω · F (Whichever is smaller)																
	Dielectric Strength	No failure																	
		<table border="1" data-bbox="933 1612 1452 1724"> <thead> <tr> <th>Step</th> <th>1</th> <th>2</th> <th>3</th> <th>4</th> </tr> </thead> <tbody> <tr> <td>Temp. (°C)</td> <td>Min. Operating Temp. $+30$</td> <td>Room Temp.</td> <td>Max. Operating Temp. $+30$</td> <td>Room Temp.</td> </tr> <tr> <td>Time (min.)</td> <td>30±3</td> <td>2 to 3</td> <td>30±3</td> <td>2 to 3</td> </tr> </tbody> </table>		Step	1	2	3	4	Temp. (°C)	Min. Operating Temp. $+30$	Room Temp.	Max. Operating Temp. $+30$	Room Temp.	Time (min.)	30±3	2 to 3	30±3	2 to 3	
Step	1	2	3	4															
Temp. (°C)	Min. Operating Temp. $+30$	Room Temp.	Max. Operating Temp. $+30$	Room Temp.															
Time (min.)	30±3	2 to 3	30±3	2 to 3															
16	Humidity, Steady State	The measured and observed characteristics should satisfy the specifications in the following table.		Let the capacitor sit at 40±2°C and 90 to 95% humidity for 500±12 hours. Remove and let sit for 24±2 hours (temperature compensating type) at room temperature, then measure.															
		Appearance	No marking defects																
		Capacitance Change	Within ±5% or ±0.5pF (Whichever is larger)																
		Q	10pF and over, 30pF and below: $Q \geq 275 + \frac{5}{2} C$ 10pF and below: $Q \geq 200 + 10C$ C: Nominal Capacitance (pF)																
	I.R.	More than 10,000MΩ or 500Ω · F (Whichever is smaller)																	

Continued on the following page. ↗

Specifications and Test Methods

Continued from the preceding page.

No.	Item	Specifications		Test Method
		Temperature Compensating Type		
17	Humidity Load	The measured and observed characteristics should satisfy the specifications in the following table.		Apply the rated voltage at 40±2°C and 90 to 95% humidity for 500±12 hours. Remove and let sit for 24±2 hours at room temperature, then measure. The charge/discharge current is less than 50mA.
		Appearance	No marking defects	
		Capacitance Change	Within ±7.5% or ±0.75pF (Whichever is larger)	
		Q	30pF and below: $Q \geq 100 + \frac{1}{3}C$ C: Nominal Capacitance (pF)	
		I.R.	More than 500MΩ or 25Ω · F (Whichever is smaller)	
	Dielectric Strength	No failure		
18	High Temperature Load	The measured and observed characteristics should satisfy the specifications in the following table.		Apply 200% of the rated voltage for 1000±12 hours at the maximum operating temperature ±3°C. Let sit for 24±2 hours (temperature compensating type) at room temperature, then measure. The charge/discharge current is less than 50mA.
		Appearance	No marking defects	
		Capacitance Change	Within ±3% or ±0.3pF (Whichever is larger)	
		Q	10pF and over, 30pF and below: $Q \geq 275 + \frac{5}{3}C$ 10pF and below: $Q \geq 200 + 10C$ C: Nominal Capacitance (pF)	
		I.R.	More than 1,000MΩ or 50Ω · F (Whichever is smaller)	
	Dielectric Strength	No failure		
19	ESR	0.5pF ≤ C ≤ 1pF: 350mΩ below 1pF < C ≤ 5pF: 300mΩ below 5pF < C ≤ 10pF: 250mΩ below		The ESR should be measured at room temperature, and frequency 1±0.2GHz with the equivalent of BOONTON Model 34A.
		10pF < C ≤ 20pF: 400mΩ below		The ESR should be measured at room temperature, and frequency 500±50MHz with the equivalent of HP8753B.

Table A
(1)

Char. Code	Temp. Coeff. (ppm/°C) *1	Capacitance Change from 25°C Value (%)					
		-55°C		-30°C		-10°C	
		Max.	Min.	Max.	Min.	Max.	Min.
5C	0±30	0.58	-0.24	0.40	-0.17	0.25	-0.11

*1: Nominal values denote the temperature coefficient within a range of 25 to 125°C.

(2)

Char.	Nominal Values (ppm/°C) *2	Capacitance Change from 20°C Value (%)					
		-55°C		-25°C		-10°C	
		Max.	Min.	Max.	Min.	Max.	Min.
2C	0±60	0.82	-0.45	0.49	-0.27	0.33	-0.18
3C	0±120	0.37	-0.90	0.82	-0.54	0.55	-0.36
4C	0±250	0.56	-0.88	1.54	-1.13	1.02	-0.75

*2: Nominal values denote the temperature coefficient within a range of 20 to 125°C.

Chip Monolithic Ceramic Capacitors



High Frequency GQM Series

■ Features

1. HiQ and low ESR at VHF, UHF, Microwave
2. Feature improvement, low power consumption for mobile telecommunications (Base station, terminal, etc.)

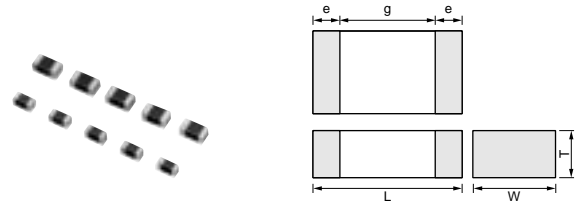

■ Applicatons

High frequency circuit (Mobile telecommunications, etc.)

Part Number	Dimensions (mm)				
	L	W	T	e	g min.
GQM188	1.6 ±0.1	0.8 ±0.1	0.8 ±0.1	0.2 to 0.5	0.5
GQM219	2.0 ±0.1	1.25 ±0.1	0.85 ±0.1	0.2 to 0.7	0.7

Part Number	GQM18		GQM21	
L x W	1.6x0.8		2.0x1.25	
TC	COG (5C)		COG (5C)	
Rated Volt.	100 (2A)	50 (1H)	100 (2A)	50 (1H)
Capacitance (Capacitance part numbering code) and T (mm) Dimension (T Dimension part numbering code)				
0.50pF(R50)	0.8(8)		0.85(9)	
0.75pF(R75)	0.8(8)		0.85(9)	
1.0pF(1R0)	0.8(8)		0.85(9)	
1.1pF(1R1)	0.8(8)		0.85(9)	
1.2pF(1R2)	0.8(8)		0.85(9)	
1.3pF(1R3)	0.8(8)		0.85(9)	
1.5pF(1R5)	0.8(8)		0.85(9)	
1.6pF(1R6)	0.8(8)		0.85(9)	
1.8pF(1R8)	0.8(8)		0.85(9)	
2.0pF(2R0)	0.8(8)		0.85(9)	
2.2pF(2R2)	0.8(8)		0.85(9)	
2.4pF(2R4)	0.8(8)		0.85(9)	
2.7pF(2R7)	0.8(8)		0.85(9)	
3.0pF(3R0)	0.8(8)		0.85(9)	
3.3pF(3R3)	0.8(8)		0.85(9)	
3.6pF(3R6)	0.8(8)		0.85(9)	
3.9pF(3R9)	0.8(8)		0.85(9)	
4.0pF(4R0)	0.8(8)		0.85(9)	
4.3pF(4R3)	0.8(8)		0.85(9)	
4.7pF(4R7)	0.8(8)		0.85(9)	
5.0pF(5R0)	0.8(8)		0.85(9)	
5.1pF(5R1)	0.8(8)		0.85(9)	
5.6pF(5R6)	0.8(8)		0.85(9)	
6.0pF(6R0)	0.8(8)		0.85(9)	
6.2pF(6R2)	0.8(8)		0.85(9)	
6.8pF(6R8)	0.8(8)		0.85(9)	
7.0pF(7R0)		0.8(8)	0.85(9)	
7.5pF(7R5)		0.8(8)	0.85(9)	
8.0pF(8R0)		0.8(8)	0.85(9)	
8.2pF(8R2)		0.8(8)	0.85(9)	
9.0pF(9R0)		0.8(8)	0.85(9)	
9.1pF(9R1)		0.8(8)	0.85(9)	
10pF(100)		0.8(8)	0.85(9)	

Continued on the following page.

Continued from the preceding page.

Part Number	GQM18		GQM21	
L x W	1.6x0.8		2.0x1.25	
TC	COG (5C)		COG (5C)	
Rated Volt.	100 (2A)	50 (1H)	100 (2A)	50 (1H)
Capacitance (Capacitance part numbering code) and T (mm) Dimension (T Dimension part numbering code)				
11pF(110)		0.8(8)	0.85(9)	
12pF(120)		0.8(8)	0.85(9)	
13pF(130)		0.8(8)	0.85(9)	
15pF(150)		0.8(8)	0.85(9)	
16pF(160)		0.8(8)	0.85(9)	
18pF(180)		0.8(8)	0.85(9)	
20pF(200)		0.8(8)		0.85(9)
22pF(220)		0.8(8)		0.85(9)
24pF(240)		0.8(8)		0.85(9)
27pF(270)		0.8(8)		0.85(9)
30pF(300)		0.8(8)		0.85(9)
33pF(330)		0.8(8)		0.85(9)
36pF(360)		0.8(8)		0.85(9)
39pF(390)		0.8(8)		0.85(9)
43pF(430)		0.8(8)		0.85(9)
47pF(470)		0.8(8)		0.85(9)
51pF(510)		0.8(8)		0.85(9)
56pF(560)		0.8(8)		0.85(9)
62pF(620)		0.8(8)		0.85(9)
68pF(680)		0.8(8)		0.85(9)
75pF(750)		0.8(8)		0.85(9)
82pF(820)		0.8(8)		0.85(9)
91pF(910)		0.8(8)		0.85(9)
100pF(101)		0.8(8)		0.85(9)

The part numbering code is shown in ().
 Dimensions are shown in mm and Rated Voltage in Vdc.

■ Q - Frequency Characteristics

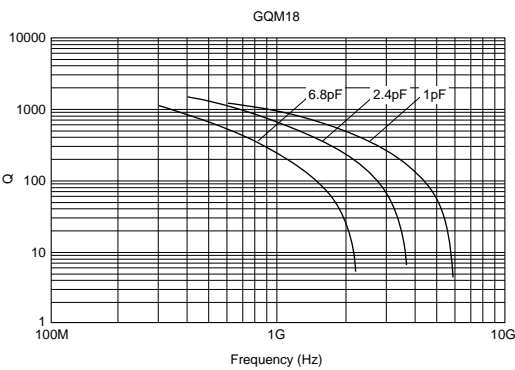

■ Resonant Frequency - Capacitance

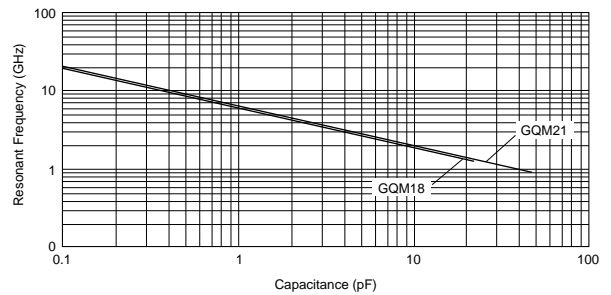

Specifications and Test Methods

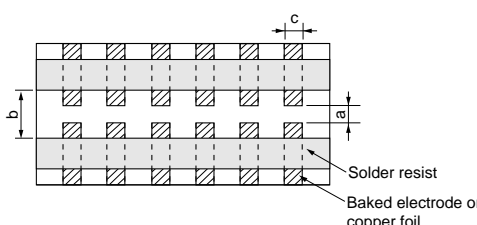
No.	Item	Specifications	Test Method																								
1	Operating Temperature	-55 to 125°C	Reference Temperature: 25°C (2C, 3C, 4C: 20°C)																								
2	Rated Voltage	See the previous page.	The rated voltage is defined as the maximum voltage which may be applied continuously to the capacitor. When AC voltage is superimposed on DC voltage, V^{P-P} or V^{O-P} , whichever is larger, should be maintained within the rated voltage range.																								
3	Appearance	No defects or abnormalities	Visual inspection																								
4	Dimension	Within the specified dimensions	Using calipers																								
5	Dielectric Strength	No defects or abnormalities	No failure should be observed when 300% of the rated voltage is applied between the terminations for 1 to 5 seconds, provided the charge/discharge current is less than 50mA.																								
6	Insulation Resistance	More than 10,000MΩ (Whichever is smaller)	The insulation resistance should be measured with a DC voltage not exceeding the rated voltage at 25°C and 75%RH max. and within 2 minutes of charging.																								
7	Capacitance	Within the specified tolerance	The capacitance/Q should be measured at 25°C at the frequency and voltage shown in the table.																								
8	Q	30pF min.: $Q \geq 1400$ 30pF max.: $Q \geq 800 + 20C$ C: Nominal Capacitance (pF)	<table border="1"> <tr> <td>Frequency</td> <td>1±0.1MHz</td> </tr> <tr> <td>Voltage</td> <td>0.5 to 5Vrms</td> </tr> </table>	Frequency	1±0.1MHz	Voltage	0.5 to 5Vrms																				
Frequency	1±0.1MHz																										
Voltage	0.5 to 5Vrms																										
9	Capacitance Temperature Characteristics	Capacitance Change	Within the specified tolerance (Table A)																								
		Temperature Coefficient	Within the specified tolerance (Table A)																								
		Capacitance Drift	Within ±0.2% or ±0.05pF (Whichever is larger)																								
10	Adhesive Strength of Termination	No removal of the terminations or other defect should occur.	<p>The temperature coefficient is determined using the capacitance measured in step 3 as a reference.</p> <p>When cycling the temperature sequentially from step 1 through 5 the capacitance should be within the specified tolerance for the temperature coefficient and capacitance change as in Table A. The capacitance drift is calculated by dividing the differences between the maximum and minimum measured values in the steps 1, 3 and 5 by the capacitance value in step 3.</p> <table border="1"> <thead> <tr> <th>Step</th> <th>Temperature (°C)</th> </tr> </thead> <tbody> <tr> <td>1</td> <td>Reference Temp. ±2</td> </tr> <tr> <td>2</td> <td>-55±3</td> </tr> <tr> <td>3</td> <td>Reference Temp. ±2</td> </tr> <tr> <td>4</td> <td>125±3</td> </tr> <tr> <td>5</td> <td>Reference Temp. ±2</td> </tr> </tbody> </table> <p>Solder the capacitor to the test jig (glass epoxy board) shown in Fig. 1 using a eutectic solder. Then apply 10N* force in parallel with the test jig for 10±1 sec. The soldering should be done either with an iron or using the reflow method and should be conducted with care so that the soldering is uniform and free of defects such as heat shock. *5N (GQM188)</p> <table border="1"> <thead> <tr> <th>Type</th> <th>a</th> <th>b</th> <th>c</th> </tr> </thead> <tbody> <tr> <td>GQM18</td> <td>1.0</td> <td>3.0</td> <td>1.2</td> </tr> <tr> <td>GQM21</td> <td>1.2</td> <td>4.0</td> <td>1.65</td> </tr> </tbody> </table> <p>(in mm)</p> <p>Fig. 1</p>	Step	Temperature (°C)	1	Reference Temp. ±2	2	-55±3	3	Reference Temp. ±2	4	125±3	5	Reference Temp. ±2	Type	a	b	c	GQM18	1.0	3.0	1.2	GQM21	1.2	4.0	1.65
		Step		Temperature (°C)																							
1	Reference Temp. ±2																										
2	-55±3																										
3	Reference Temp. ±2																										
4	125±3																										
5	Reference Temp. ±2																										
Type	a	b	c																								
GQM18	1.0	3.0	1.2																								
GQM21	1.2	4.0	1.65																								
																											
11	Vibration Resistance	Appearance	No defects or abnormalities																								
		Capacitance	Within the specified tolerance																								
		Q	30pF min.: $Q \geq 1400$ 30pF max.: $Q \geq 800 + 20C$ C: Nominal Capacitance (pF)																								
			Solder the capacitor to the test jig (glass epoxy board) in the same manner and under the same conditions as (10). The capacitor should be subjected to a simple harmonic motion having a total amplitude of 1.5mm, the frequency being varied uniformly between the approximate limits of 10 and 55Hz. The frequency range, from 10 to 55Hz and return to 10Hz, should be traversed in approximately 1 minute. This motion should be applied for a period of 2 hours in each of 3 mutually perpendicular directions (total of 6 hours).																								

Continued on the following page. 

Specifications and Test Methods

Continued from the preceding page.

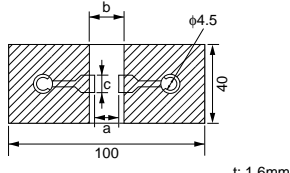
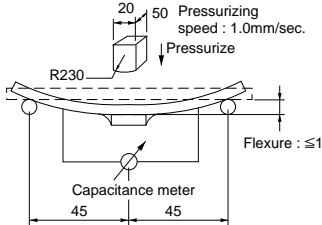
No.	Item	Specifications	Test Method													
12	Deflection	No crack or marked defect should occur.	Solder the capacitor on the test jig (glass epoxy board) shown in Fig. 2 using a eutectic solder. Then apply a force in the direction shown in Fig. 3. The soldering should be done by the reflow method and should be conducted with care so that the soldering is uniform and free of defects such as heat shock.													
		 <table border="1" style="margin: 10px auto; border-collapse: collapse;"> <thead> <tr> <th style="text-align: center;">Type</th> <th style="text-align: center;">a</th> <th style="text-align: center;">b</th> <th style="text-align: center;">c</th> </tr> </thead> <tbody> <tr> <td style="text-align: center;">GQM18</td> <td style="text-align: center;">1.0</td> <td style="text-align: center;">3.0</td> <td style="text-align: center;">1.2</td> </tr> <tr> <td style="text-align: center;">GQM21</td> <td style="text-align: center;">1.2</td> <td style="text-align: center;">4.0</td> <td style="text-align: center;">1.65</td> </tr> </tbody> </table> <p style="text-align: center;">(in mm)</p> <p style="text-align: center;">Fig. 2</p>		Type	a	b	c	GQM18	1.0	3.0	1.2	GQM21	1.2	4.0	1.65	
Type	a	b	c													
GQM18	1.0	3.0	1.2													
GQM21	1.2	4.0	1.65													
		 <p style="text-align: center;">Fig. 3</p>														
13	Solderability of Termination	75% of the terminations are to be soldered evenly and continuously.	Immerse the capacitor in a solution of ethanol (JIS-K-8101) and rosin (JIS-K-5902) (25% rosin in weight proportion). Preheat at 80 to 120°C for 10 to 30 seconds. After preheating, immerse in eutectic solder solution for 2±0.5 seconds at 230±5°C or Sn-3.0Ag-0.5Cu solder solution for 2±0.5 seconds at 245±5°C.													
14	Resistance to Soldering Heat	The measured and observed characteristics should satisfy the specifications in the following table.	Preheat the capacitor at 120 to 150°C for 1 minute. Immerse the capacitor in a eutectic solder or Sn-3.0Ag-0.5Cu solder solution at 270±5°C for 10±0.5 seconds. Let sit at room temperature for 24±2 hours.													
		<table border="1" style="width: 100%; border-collapse: collapse;"> <tr> <td style="width: 10%; text-align: center;">Appearance</td> <td>No marking defects</td> </tr> <tr> <td style="text-align: center;">Capacitance Change</td> <td>Within ±2.5% or ±0.25 pF (Whichever is larger)</td> </tr> <tr> <td style="text-align: center;">Q</td> <td>30pF min.: Q≥1400 30pF max.: Q≥800+20C C: Nominal Capacitance (pF)</td> </tr> <tr> <td style="text-align: center;">I.R.</td> <td>More than 10,000MΩ</td> </tr> <tr> <td style="text-align: center;">Dielectric Strength</td> <td>No failure</td> </tr> </table>		Appearance	No marking defects	Capacitance Change	Within ±2.5% or ±0.25 pF (Whichever is larger)	Q	30pF min.: Q≥1400 30pF max.: Q≥800+20C C: Nominal Capacitance (pF)	I.R.	More than 10,000MΩ	Dielectric Strength	No failure			
		Appearance		No marking defects												
		Capacitance Change		Within ±2.5% or ±0.25 pF (Whichever is larger)												
		Q		30pF min.: Q≥1400 30pF max.: Q≥800+20C C: Nominal Capacitance (pF)												
I.R.	More than 10,000MΩ															
Dielectric Strength	No failure															
The measured and observed characteristics should satisfy the specifications in the following table.	Fix the capacitor to the supporting jig in the same manner and under the same conditions as (10). Perform the five cycles according to the four heat treatments listed in the following table. Let sit for 24±2 hours at room temperature, then measure.															
<table border="1" style="width: 100%; border-collapse: collapse;"> <thead> <tr> <th style="text-align: center;">Step</th> <th style="text-align: center;">1</th> <th style="text-align: center;">2</th> <th style="text-align: center;">3</th> <th style="text-align: center;">4</th> </tr> </thead> <tbody> <tr> <td style="text-align: center;">Temp. (°C)</td> <td style="text-align: center;">Min. Operating Temp. +0/-3</td> <td style="text-align: center;">Room Temp.</td> <td style="text-align: center;">Max. Operating Temp. +3/-0</td> <td style="text-align: center;">Room Temp.</td> </tr> <tr> <td style="text-align: center;">Time (min.)</td> <td style="text-align: center;">30±3</td> <td style="text-align: center;">2 to 3</td> <td style="text-align: center;">30±3</td> <td style="text-align: center;">2 to 3</td> </tr> </tbody> </table>		Step	1	2	3	4	Temp. (°C)	Min. Operating Temp. +0/-3	Room Temp.	Max. Operating Temp. +3/-0	Room Temp.	Time (min.)	30±3	2 to 3	30±3	2 to 3
Step		1	2	3	4											
Temp. (°C)		Min. Operating Temp. +0/-3	Room Temp.	Max. Operating Temp. +3/-0	Room Temp.											
Time (min.)	30±3	2 to 3	30±3	2 to 3												
<table border="1" style="width: 100%; border-collapse: collapse;"> <tr> <td style="width: 10%; text-align: center;">Appearance</td> <td>No marking defects</td> </tr> <tr> <td style="text-align: center;">Capacitance Change</td> <td>Within ±2.5% or ±0.25pF (Whichever is larger)</td> </tr> <tr> <td style="text-align: center;">Q</td> <td>30pF min.: Q≥1400 30pF max.: Q≥800+20C C: Nominal Capacitance (pF)</td> </tr> <tr> <td style="text-align: center;">I.R.</td> <td>More than 10,000MΩ</td> </tr> <tr> <td style="text-align: center;">Dielectric Strength</td> <td>No failure</td> </tr> </table>	Appearance	No marking defects	Capacitance Change	Within ±2.5% or ±0.25pF (Whichever is larger)	Q	30pF min.: Q≥1400 30pF max.: Q≥800+20C C: Nominal Capacitance (pF)	I.R.	More than 10,000MΩ	Dielectric Strength	No failure						
Appearance	No marking defects															
Capacitance Change	Within ±2.5% or ±0.25pF (Whichever is larger)															
Q	30pF min.: Q≥1400 30pF max.: Q≥800+20C C: Nominal Capacitance (pF)															
I.R.	More than 10,000MΩ															
Dielectric Strength	No failure															
<table border="1" style="width: 100%; border-collapse: collapse;"> <tr> <td style="width: 10%; text-align: center;">Appearance</td> <td>No marking defects</td> </tr> <tr> <td style="text-align: center;">Capacitance Change</td> <td>Within ±5% or ±0.5pF (Whichever is larger)</td> </tr> <tr> <td style="text-align: center;">Q</td> <td>30pF min.: Q≥350 10pF and over, 30pF and below: Q≥275+5C/2 10pF max.: Q≥200+10C C: Nominal Capacitance (pF)</td> </tr> <tr> <td style="text-align: center;">I.R.</td> <td>More than 1,000MΩ</td> </tr> <tr> <td style="text-align: center;">Dielectric Strength</td> <td>No failure</td> </tr> </table>	Appearance	No marking defects	Capacitance Change	Within ±5% or ±0.5pF (Whichever is larger)	Q	30pF min.: Q≥350 10pF and over, 30pF and below: Q≥275+5C/2 10pF max.: Q≥200+10C C: Nominal Capacitance (pF)	I.R.	More than 1,000MΩ	Dielectric Strength	No failure						
Appearance	No marking defects															
Capacitance Change	Within ±5% or ±0.5pF (Whichever is larger)															
Q	30pF min.: Q≥350 10pF and over, 30pF and below: Q≥275+5C/2 10pF max.: Q≥200+10C C: Nominal Capacitance (pF)															
I.R.	More than 1,000MΩ															
Dielectric Strength	No failure															
16	Humidity Steady State	The measured and observed characteristics should satisfy the specifications in the following table.	Let the capacitor sit at 40±2°C and 90 to 95% humidity for 500±12 hours. Remove and let sit for 24±2 hours (temperature compensating type) at room temperature, then measure.													

Continued on the following page.

Specifications and Test Methods

Continued from the preceding page.

No.	Item	Specifications	Test Method	
17	Humidity Load	The measured and observed characteristics should satisfy the specifications in the following table.	Apply the rated voltage at 40±2°C and 90 to 95% humidity for 500±12 hours. Remove and let sit for 24±2 hours at room temperature then measure. The charge/discharge current is less than 50mA.	
		Appearance		No marking defects
		Capacitance Change		Within ±7.5% or ±0.75pF (Whichever is larger)
		Q		30pF min.: $Q \geq 200$ 30pF max.: $Q \geq 100 + 10C/3$ C: Nominal Capacitance (pF)
		I.R.		More than 500MΩ
18	High Temperature Load	The measured and observed characteristics should satisfy the specifications in the following table.	Apply 200% of the rated voltage for 1000±12 hours at the maximum operating temperature ±3°C. Let sit for 24±2 hours (temperature compensating type) at room temperature, then measure. The charge/discharge current is less than 50mA.	
		Appearance		No marking defects
		Capacitance Change		Within ±3% or ±0.3pF (Whichever is larger)
		Q		30pF min.: $Q \geq 350$ 10pF and over, 30pF and below: $Q \geq 275 + 5C/2$ 10pF max.: $Q \geq 200 + 10C$ C: Nominal Capacitance (pF)
		I.R.		More than 1,000MΩ
	Dielectric Strength	No failure		

Table A
(1)

Char.	Nominal Values (ppm/°C) *1	Capacitance Change from 25°C (%)					
		-55°C		-30°C		-10°C	
		Max.	Min.	Max.	Min.	Max.	Min.
5C	0±30	0.58	-0.24	0.40	-0.17	0.25	-0.11

*1: Nominal values denote the temperature coefficient within a range of 25 to 125°C.

Chip Monolithic Ceramic Capacitors



High Frequency Type ERB Series

■ Features (ERB Series)

1. Negligible inductance is achieved by its monolithic structure so the series can be used at frequencies above 1GHz.
2. Nickel barriered terminations of ERB series improve solderability and decrease solder leaching.
3. ERB18/21 series are designed for both flow and reflow soldering and ERB32 series are designed for reflow soldering.

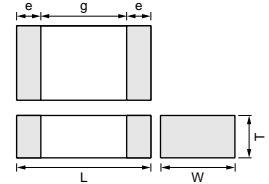

Part Number	Dimensions (mm)				
	L	W	T max.	e min.	g min.
ERB188	1.6±0.1	0.8±0.1	0.9	0.2	0.5
ERB21B	2.0±0.3	1.25±0.3	1.35	0.25	0.7
ERB32Q	3.2±0.3	2.5±0.3	1.7	0.3	1.0

■ Applications

High frequency and high-power circuits

Part Number	ERB18		ERB21				ERB32					
L x W	1.6x0.8		2.0x1.25				3.2x2.5					
TC	COG (5C)		COG (5C)				COG (5C)					
Rated Volt.	250 (2E)	200 (2D)	250 (2E)	200 (2D)	100 (2A)	50 (1H)	500 (2H)	300 (YD)	250 (2E)	200 (2D)	100 (2A)	50 (1H)
Capacitance (Capacitance part numbering code) and T (mm) Dimension (T Dimension part numbering code)												
0.50pF(50)	0.9(8)	0.9(8)	1.35(B)	1.35(B)			1.7(Q)					
0.75pF(75)	0.9(8)	0.9(8)	1.35(B)	1.35(B)			1.7(Q)					
1.0pF(1R0)	0.9(8)	0.9(8)	1.35(B)	1.35(B)			1.7(Q)					
1.1pF(1R1)	0.9(8)	0.9(8)	1.35(B)	1.35(B)			1.7(Q)					
1.2pF(1R2)	0.9(8)	0.9(8)	1.35(B)	1.35(B)			1.7(Q)					
1.3pF(1R3)	0.9(8)	0.9(8)	1.35(B)	1.35(B)			1.7(Q)					
1.5pF(1R5)	0.9(8)	0.9(8)	1.35(B)	1.35(B)			1.7(Q)					
1.6pF(1R6)	0.9(8)	0.9(8)	1.35(B)	1.35(B)			1.7(Q)					
1.8pF(1R8)	0.9(8)	0.9(8)	1.35(B)	1.35(B)			1.7(Q)					
2.0pF(2R0)	0.9(8)	0.9(8)	1.35(B)	1.35(B)			1.7(Q)					
2.2pF(2R2)	0.9(8)	0.9(8)	1.35(B)	1.35(B)			1.7(Q)					
2.4pF(2R4)	0.9(8)	0.9(8)	1.35(B)	1.35(B)			1.7(Q)					
2.7pF(2R7)	0.9(8)	0.9(8)	1.35(B)	1.35(B)			1.7(Q)					
3.0pF(3R0)	0.9(8)	0.9(8)	1.35(B)	1.35(B)			1.7(Q)					
3.3pF(3R3)	0.9(8)	0.9(8)	1.35(B)	1.35(B)			1.7(Q)					
3.6pF(3R6)	0.9(8)	0.9(8)	1.35(B)	1.35(B)			1.7(Q)					
3.9pF(3R9)	0.9(8)	0.9(8)	1.35(B)	1.35(B)			1.7(Q)					
4.0pF(4R0)	0.9(8)	0.9(8)	1.35(B)	1.35(B)			1.7(Q)					
4.3pF(4R3)	0.9(8)	0.9(8)	1.35(B)	1.35(B)			1.7(Q)					
4.7pF(4R7)	0.9(8)	0.9(8)	1.35(B)	1.35(B)			1.7(Q)					
5.0pF(5R0)	0.9(8)	0.9(8)	1.35(B)	1.35(B)			1.7(Q)					
5.1pF(5R1)	0.9(8)	0.9(8)	1.35(B)	1.35(B)			1.7(Q)					
5.6pF(5R6)	0.9(8)	0.9(8)	1.35(B)	1.35(B)			1.7(Q)					
6.0pF(6R0)	0.9(8)	0.9(8)	1.35(B)	1.35(B)			1.7(Q)					
6.2pF(6R2)	0.9(8)	0.9(8)	1.35(B)	1.35(B)			1.7(Q)					
6.8pF(6R8)	0.9(8)	0.9(8)	1.35(B)	1.35(B)			1.7(Q)					
7.0pF(7R0)	0.9(8)	0.9(8)	1.35(B)	1.35(B)			1.7(Q)					
7.5pF(7R5)	0.9(8)	0.9(8)	1.35(B)	1.35(B)			1.7(Q)					
8.0pF(8R0)	0.9(8)	0.9(8)	1.35(B)	1.35(B)			1.7(Q)					
8.2pF(8R2)	0.9(8)	0.9(8)	1.35(B)	1.35(B)			1.7(Q)					
9.0pF(9R0)	0.9(8)	0.9(8)	1.35(B)	1.35(B)			1.7(Q)					
9.1pF(9R1)	0.9(8)	0.9(8)	1.35(B)	1.35(B)			1.7(Q)					

Continued on the following page.

Continued from the preceding page.

Part Number	ERB18		ERB21				ERB32					
L x W	1.6x0.8		2.0x1.25				3.2x2.5					
TC	COG (5C)		COG (5C)				COG (5C)					
Rated Volt.	250 (2E)	200 (2D)	250 (2E)	200 (2D)	100 (2A)	50 (1H)	500 (2H)	300 (YD)	250 (2E)	200 (2D)	100 (2A)	50 (1H)
Capacitance (Capacitance part numbering code) and T (mm) Dimension (T Dimension part numbering code)												
10pF(100)	0.9(8)	0.9(8)	1.35(B)	1.35(B)			1.7(Q)					
11pF(110)	0.9(8)	0.9(8)	1.35(B)	1.35(B)			1.7(Q)					
12pF(120)	0.9(8)	0.9(8)	1.35(B)	1.35(B)			1.7(Q)					
13pF(130)	0.9(8)	0.9(8)	1.35(B)	1.35(B)			1.7(Q)					
15pF(150)	0.9(8)	0.9(8)	1.35(B)	1.35(B)			1.7(Q)					
16pF(160)	0.9(8)	0.9(8)	1.35(B)	1.35(B)			1.7(Q)					
18pF(180)	0.9(8)	0.9(8)	1.35(B)	1.35(B)			1.7(Q)					
20pF(200)	0.9(8)	0.9(8)	1.35(B)	1.35(B)			1.7(Q)					
22pF(220)	0.9(8)	0.9(8)	1.35(B)	1.35(B)			1.7(Q)					
24pF(240)	0.9(8)	0.9(8)	1.35(B)	1.35(B)			1.7(Q)					
27pF(270)	0.9(8)	0.9(8)	1.35(B)	1.35(B)			1.7(Q)					
30pF(300)	0.9(8)	0.9(8)	1.35(B)	1.35(B)			1.7(Q)					
33pF(330)	0.9(8)	0.9(8)	1.35(B)	1.35(B)			1.7(Q)					
36pF(360)	0.9(8)	0.9(8)	1.35(B)	1.35(B)			1.7(Q)					
39pF(390)	0.9(8)	0.9(8)	1.35(B)	1.35(B)			1.7(Q)					
43pF(430)	0.9(8)	0.9(8)	1.35(B)	1.35(B)			1.7(Q)					
47pF(470)	0.9(8)	0.9(8)	1.35(B)	1.35(B)			1.7(Q)					
51pF(510)	0.9(8)	0.9(8)	1.35(B)	1.35(B)			1.7(Q)					
56pF(560)	0.9(8)	0.9(8)	1.35(B)	1.35(B)			1.7(Q)					
62pF(620)	0.9(8)	0.9(8)	1.35(B)	1.35(B)			1.7(Q)					
68pF(680)	0.9(8)	0.9(8)	1.35(B)	1.35(B)			1.7(Q)					
75pF(750)	0.9(8)	0.9(8)	1.35(B)	1.35(B)			1.7(Q)					
82pF(820)	0.9(8)	0.9(8)	1.35(B)	1.35(B)			1.7(Q)					
91pF(910)	0.9(8)	0.9(8)	1.35(B)	1.35(B)			1.7(Q)					
100pF(101)	0.9(8)	0.9(8)	1.35(B)	1.35(B)			1.7(Q)					
110pF(111)						1.35(B)	1.7(Q)					
120pF(121)						1.35(B)	1.7(Q)					
130pF(131)						1.35(B)		1.7(Q)				
150pF(151)							1.35(B)	1.7(Q)				
160pF(161)							1.35(B)		1.7(Q)	1.7(Q)		
180pF(181)									1.7(Q)	1.7(Q)		
200pF(201)									1.7(Q)	1.7(Q)		
220pF(221)									1.7(Q)	1.7(Q)		
240pF(241)											1.7(Q)	
270pF(271)											1.7(Q)	
300pF(301)											1.7(Q)	
330pF(331)											1.7(Q)	
360pF(361)											1.7(Q)	
390pF(391)											1.7(Q)	
430pF(431)											1.7(Q)	
470pF(471)											1.7(Q)	
510pF(511)												1.7(Q)
560pF(561)												1.7(Q)
620pF(621)												1.7(Q)
680pF(681)												1.7(Q)
750pF(751)												1.7(Q)
820pF(821)												1.7(Q)
910pF(911)												1.7(Q)
1000pF(102)												1.7(Q)

The part numbering code is shown in ().
Dimensions are shown in mm and Rated Voltage in Vdc.

Specifications and Test Methods

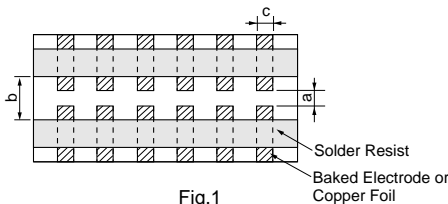
No.	Item	Specifications	Test Method																												
1	Operating Temperature Range	-55 to +125°C	Reference Temperature: 25°C																												
2	Rated Voltage	See the previous pages.	The rated voltage is defined as the maximum voltage which may be applied continuously to the capacitor. When AC voltage is superimposed on DC voltage, V^{P-P} or V^{O-P} , whichever is larger, should be maintained within the rated voltage range.																												
3	Appearance	No defects or abnormalities	Visual inspection																												
4	Dimensions	Within the specified dimension	Using calipers																												
5	Dielectric Strength	No defects or abnormalities	No failure should be observed when 300%(*) of the rated voltage is applied between the terminations for 1 to 5 seconds, provided the charge/discharge current is less than 50mA. (*) 300V: 250%, 500V: 200%																												
6	Insulation Resistance (I.R.)	1,000,000MΩ min. (C≤470pF) 100,000MΩ min. (C>470pF)	The insulation resistance should be measured with a DC voltage not exceeding the rated voltage at 25°C and standard humidity and within 2 minutes of charging.																												
7	Capacitance	Within the specified tolerance	The capacitance/Q should be measured at 25°C at the frequency and voltage shown in the table.																												
8	Q	$C \leq 220\text{pF} : Q \geq 10,000$ $220\text{pF} < C \leq 470\text{pF} : Q \geq 5,000$ $470\text{pF} < C \leq 1,000\text{pF} : Q \geq 3,000$ C: Nominal Capacitance (pF)	<table border="1" style="margin-left: auto; margin-right: auto;"> <tr> <td>Frequency</td> <td>1±0.1MHz</td> </tr> <tr> <td>Voltage</td> <td>1±0.2Vrms</td> </tr> </table>	Frequency	1±0.1MHz	Voltage	1±0.2Vrms																								
Frequency	1±0.1MHz																														
Voltage	1±0.2Vrms																														
9	Capacitance Temperature Characteristics	Capacitance Change	The temperature coefficient is determined using the capacitance measured in step 3 as a reference. When cycling the temperature sequentially from step 1 through 5, the capacitance should be within the specified tolerance for the temperature coefficient and capacitance change as Table A. The capacitance drift is calculated by dividing the differences between the maximum and minimum measured values in steps 1, 3 and 5 by the capacitance value in step 3.																												
		Temperature Coefficient																													
		Capacitance Drift		Within ±0.2% or ±0.05pF (Whichever is larger)																											
10	Adhesive Strength of Termination	No removal of the terminations or other defects should occur.	Solder the capacitor on the test jig (glass epoxy board) shown in Fig. 1 using an eutectic solder. Then apply 10N* force in parallel with the test jig for 10±1sec. The soldering should be done either with an iron or using the reflow method and should be conducted with care so that the soldering is uniform and free of defects such as heat shock.																												
																															
			<table border="1" style="margin-left: auto; margin-right: auto;"> <thead> <tr> <th>Step</th> <th>Temperature (°C)</th> </tr> </thead> <tbody> <tr> <td>1</td> <td>25±2</td> </tr> <tr> <td>2</td> <td>-55±3</td> </tr> <tr> <td>3</td> <td>25±2</td> </tr> <tr> <td>4</td> <td>125±3</td> </tr> <tr> <td>5</td> <td>25±2</td> </tr> </tbody> </table> <table border="1" style="margin-left: auto; margin-right: auto;"> <thead> <tr> <th>Type</th> <th>a</th> <th>b</th> <th>c</th> </tr> </thead> <tbody> <tr> <td>ERB18</td> <td>1.0</td> <td>3.0</td> <td>1.2</td> </tr> <tr> <td>ERB21</td> <td>1.2</td> <td>4.0</td> <td>1.65</td> </tr> <tr> <td>ERB32</td> <td>2.2</td> <td>5.0</td> <td>2.9</td> </tr> </tbody> </table> <p style="text-align: right;">(in mm) *5N (ERB188)</p>	Step	Temperature (°C)	1	25±2	2	-55±3	3	25±2	4	125±3	5	25±2	Type	a	b	c	ERB18	1.0	3.0	1.2	ERB21	1.2	4.0	1.65	ERB32	2.2	5.0	2.9
Step	Temperature (°C)																														
1	25±2																														
2	-55±3																														
3	25±2																														
4	125±3																														
5	25±2																														
Type	a	b	c																												
ERB18	1.0	3.0	1.2																												
ERB21	1.2	4.0	1.65																												
ERB32	2.2	5.0	2.9																												

Continued on the following page.

Specifications and Test Methods

Continued from the preceding page.

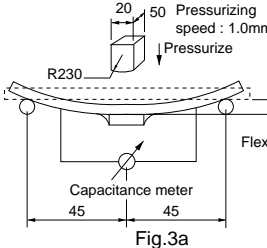
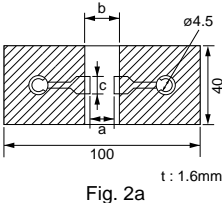
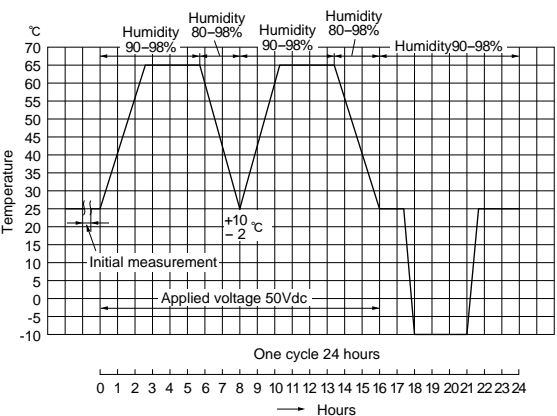
No.	Item	Specifications	Test Method																											
11	Appearance	No defects or abnormalities	Solder the capacitor to the test jig (glass epoxy board) in the same manner and under the same conditions as (10). The capacitor should be subjected to a simple harmonic motion having a total amplitude of 1.5mm, the frequency being varied uniformly between the approximate limits of 10 and 55Hz. The frequency range, from 10 to 55Hz and return to 10Hz, should be traversed in approximately 1 minute. This motion should be applied for a period of 2 hours in each of 3 mutually perpendicular directions (total of 6 hours).																											
	Capacitance	Within the specified tolerance																												
12	Vibration Resistance	Q	Satisfies the initial value. $C \leq 220\text{pF} : Q \geq 10,000$ $220\text{pF} < C \leq 470\text{pF} : Q \geq 5,000$ $470\text{pF} < C \leq 1,000\text{pF} : Q \geq 3,000$ C: Nominal Capacitance (pF)																											
		Deflection	No crack or marked defect should occur.  																											
13	Solderability of Termination	95% of the terminations are to be soldered evenly and continuously.	Solder the capacitor on the test jig (glass epoxy board) shown in Fig. 2a using an eutectic solder. Then apply a force in the direction shown in Fig. 3a. The soldering should be done by the reflow method and should be conducted with care so that the soldering is uniform and free of defects such as heat shock. <table border="1" data-bbox="938 667 1452 772"> <thead> <tr> <th>Type</th> <th>a</th> <th>b</th> <th>c</th> </tr> </thead> <tbody> <tr> <td>ERB18</td> <td>1.0</td> <td>3.0</td> <td>1.2</td> </tr> <tr> <td>ERB21</td> <td>1.2</td> <td>4.0</td> <td>1.65</td> </tr> <tr> <td>ERB32</td> <td>2.2</td> <td>5.0</td> <td>2.9</td> </tr> </tbody> </table> (in mm)	Type	a	b	c	ERB18	1.0	3.0	1.2	ERB21	1.2	4.0	1.65	ERB32	2.2	5.0	2.9											
Type	a	b	c																											
ERB18	1.0	3.0	1.2																											
ERB21	1.2	4.0	1.65																											
ERB32	2.2	5.0	2.9																											
14	Resistance to Soldering Heat	The measured and observed characteristics should satisfy the specifications in the following table. <table border="1" data-bbox="370 1041 880 1236"> <thead> <tr> <th>Item</th> <th>Specifications</th> </tr> </thead> <tbody> <tr> <td>Appearance</td> <td>No marked defect</td> </tr> <tr> <td>Capacitance Change</td> <td>Within $\pm 2.5\%$ or $\pm 0.25\text{pF}$ (Whichever is larger)</td> </tr> <tr> <td>Q</td> <td>$C \leq 220\text{pF} : Q \geq 10,000$ $220\text{pF} < C \leq 470\text{pF} : Q \geq 5,000$ $470\text{pF} < C \leq 1,000\text{pF} : Q \geq 3,000$</td> </tr> <tr> <td>Dielectric Strength</td> <td>No failure</td> </tr> </tbody> </table> C: Nominal Capacitance (pF)	Item	Specifications	Appearance	No marked defect	Capacitance Change	Within $\pm 2.5\%$ or $\pm 0.25\text{pF}$ (Whichever is larger)	Q	$C \leq 220\text{pF} : Q \geq 10,000$ $220\text{pF} < C \leq 470\text{pF} : Q \geq 5,000$ $470\text{pF} < C \leq 1,000\text{pF} : Q \geq 3,000$	Dielectric Strength	No failure	Preheat according to the conditions listed in the table below. Immerse the capacitor in an eutectic solder or Sn-3.0Ag-0.5Cu solder solution at $270 \pm 5^\circ\text{C}$ for 10 ± 0.5 seconds. Let sit at room temperature for 24 ± 2 hours. <table border="1" data-bbox="938 1115 1452 1198"> <thead> <tr> <th>Chip Size</th> <th>Preheat Condition</th> </tr> </thead> <tbody> <tr> <td>2.0x1.25mm max.</td> <td>1minute at 120 to 150°C</td> </tr> <tr> <td>3.2x2.5mm</td> <td>Each 1 minute at 100 to 120°C and then 170 to 200°C</td> </tr> </tbody> </table>	Chip Size	Preheat Condition	2.0x1.25mm max.	1minute at 120 to 150°C	3.2x2.5mm	Each 1 minute at 100 to 120°C and then 170 to 200°C											
Item	Specifications																													
Appearance	No marked defect																													
Capacitance Change	Within $\pm 2.5\%$ or $\pm 0.25\text{pF}$ (Whichever is larger)																													
Q	$C \leq 220\text{pF} : Q \geq 10,000$ $220\text{pF} < C \leq 470\text{pF} : Q \geq 5,000$ $470\text{pF} < C \leq 1,000\text{pF} : Q \geq 3,000$																													
Dielectric Strength	No failure																													
Chip Size	Preheat Condition																													
2.0x1.25mm max.	1minute at 120 to 150°C																													
3.2x2.5mm	Each 1 minute at 100 to 120°C and then 170 to 200°C																													
15	Temperature Cycle	The measured and observed characteristics should satisfy the specifications in the following table. <table border="1" data-bbox="370 1339 880 1556"> <thead> <tr> <th>Item</th> <th>Specifications</th> </tr> </thead> <tbody> <tr> <td>Appearance</td> <td>No marked defect</td> </tr> <tr> <td>Capacitance Change</td> <td>Within $\pm 5\%$ or $\pm 0.5\text{pF}$ (Whichever is larger)</td> </tr> <tr> <td>Q</td> <td>$C \geq 30\text{pF} : Q \geq 350$ $10\text{pF} \leq C < 30\text{pF} : Q \geq 275 + \frac{C}{10}$ $C < 10\text{pF} : Q \geq 200 + 10C$</td> </tr> <tr> <td>I.R.</td> <td>1,000MΩ min.</td> </tr> <tr> <td>Dielectric Strength</td> <td>No failure</td> </tr> </tbody> </table> C: Nominal Capacitance (pF)	Item	Specifications	Appearance	No marked defect	Capacitance Change	Within $\pm 5\%$ or $\pm 0.5\text{pF}$ (Whichever is larger)	Q	$C \geq 30\text{pF} : Q \geq 350$ $10\text{pF} \leq C < 30\text{pF} : Q \geq 275 + \frac{C}{10}$ $C < 10\text{pF} : Q \geq 200 + 10C$	I.R.	1,000MΩ min.	Dielectric Strength	No failure	Fix the capacitor to the supporting jig in the same manner and under the same conditions as (10). Perform the five cycles according to the four heat treatments listed in the following table. Let sit for 24 ± 2 hours at room temperature, then measure. <table border="1" data-bbox="938 1415 1452 1545"> <thead> <tr> <th>Step</th> <th>1</th> <th>2</th> <th>3</th> <th>4</th> </tr> </thead> <tbody> <tr> <td>Temp. (°C)</td> <td>Min. Operating Temp. +0/-3</td> <td>Room Temp.</td> <td>Max. Operating Temp. +3/-0</td> <td>Room Temp.</td> </tr> <tr> <td>Time (min.)</td> <td>30±3</td> <td>5 max.</td> <td>30±3</td> <td>5 max.</td> </tr> </tbody> </table>	Step	1	2	3	4	Temp. (°C)	Min. Operating Temp. +0/-3	Room Temp.	Max. Operating Temp. +3/-0	Room Temp.	Time (min.)	30±3	5 max.	30±3	5 max.
Item	Specifications																													
Appearance	No marked defect																													
Capacitance Change	Within $\pm 5\%$ or $\pm 0.5\text{pF}$ (Whichever is larger)																													
Q	$C \geq 30\text{pF} : Q \geq 350$ $10\text{pF} \leq C < 30\text{pF} : Q \geq 275 + \frac{C}{10}$ $C < 10\text{pF} : Q \geq 200 + 10C$																													
I.R.	1,000MΩ min.																													
Dielectric Strength	No failure																													
Step	1	2	3	4																										
Temp. (°C)	Min. Operating Temp. +0/-3	Room Temp.	Max. Operating Temp. +3/-0	Room Temp.																										
Time (min.)	30±3	5 max.	30±3	5 max.																										
16	Humidity	The measured and observed characteristics should satisfy the specifications in the following table. <table border="1" data-bbox="370 1774 880 1966"> <thead> <tr> <th>Item</th> <th>Specifications</th> </tr> </thead> <tbody> <tr> <td>Appearance</td> <td>No marked defect</td> </tr> <tr> <td>Capacitance Change</td> <td>Within $\pm 5\%$ or $\pm 0.5\text{pF}$ (Whichever is larger)</td> </tr> <tr> <td>Q</td> <td>$C \geq 30\text{pF} : Q \geq 350$ $10\text{pF} \leq C < 30\text{pF} : Q \geq 275 + \frac{C}{10}$ $C < 10\text{pF} : Q \geq 200 + 10C$</td> </tr> <tr> <td>I.R.</td> <td>1,000MΩ min.</td> </tr> </tbody> </table> C: Nominal Capacitance (pF)	Item	Specifications	Appearance	No marked defect	Capacitance Change	Within $\pm 5\%$ or $\pm 0.5\text{pF}$ (Whichever is larger)	Q	$C \geq 30\text{pF} : Q \geq 350$ $10\text{pF} \leq C < 30\text{pF} : Q \geq 275 + \frac{C}{10}$ $C < 10\text{pF} : Q \geq 200 + 10C$	I.R.	1,000MΩ min.	Apply the 24-hour heat (-10 to $+65^\circ\text{C}$) and humidity (80 to 100%) treatment shown below, 10 consecutive times. Remove, let sit for 24 ± 2 hours at room temperature, and measure. 																	
Item	Specifications																													
Appearance	No marked defect																													
Capacitance Change	Within $\pm 5\%$ or $\pm 0.5\text{pF}$ (Whichever is larger)																													
Q	$C \geq 30\text{pF} : Q \geq 350$ $10\text{pF} \leq C < 30\text{pF} : Q \geq 275 + \frac{C}{10}$ $C < 10\text{pF} : Q \geq 200 + 10C$																													
I.R.	1,000MΩ min.																													

Continued on the following page. ↗

Specifications and Test Methods

Continued from the preceding page.

No.	Item	Specifications	Test Method												
17	High Temperature Load	<p>The measured and observed characteristics should satisfy the specifications in the following table.</p> <table border="1" style="width: 100%; border-collapse: collapse; margin-bottom: 5px;"> <thead> <tr> <th style="width: 30%;">Item</th> <th style="width: 70%;">Specifications</th> </tr> </thead> <tbody> <tr> <td>Appearance</td> <td>No marked defect</td> </tr> <tr> <td>Capacitance Change</td> <td>Within $\pm 3\%$ or $\pm 0.3\text{pF}$ (Whichever is larger)</td> </tr> <tr> <td>Q</td> <td>$C \geq 30\text{pF} : Q \geq 350$ $10\text{pF} \leq C < 30\text{pF} : Q \geq 275 + \frac{5}{2} C$ $C < 10\text{pF} : Q \geq 200 + 10C$</td> </tr> <tr> <td>I.R.</td> <td>1,000MΩ min.</td> </tr> <tr> <td>Dielectric Strength</td> <td>No failure</td> </tr> </tbody> </table> <p style="text-align: right; margin-right: 50px;">C: Nominal Capacitance (pF)</p>	Item	Specifications	Appearance	No marked defect	Capacitance Change	Within $\pm 3\%$ or $\pm 0.3\text{pF}$ (Whichever is larger)	Q	$C \geq 30\text{pF} : Q \geq 350$ $10\text{pF} \leq C < 30\text{pF} : Q \geq 275 + \frac{5}{2} C$ $C < 10\text{pF} : Q \geq 200 + 10C$	I.R.	1,000M Ω min.	Dielectric Strength	No failure	<p>Apply 200% (500V only 150%) of the rated voltage for 1,000\pm12 hours at 125\pm3$^{\circ}$C. Remove and let sit for 24\pm2 hours at room temperature, then measure. The charge/discharge current is less than 50mA.</p>
Item	Specifications														
Appearance	No marked defect														
Capacitance Change	Within $\pm 3\%$ or $\pm 0.3\text{pF}$ (Whichever is larger)														
Q	$C \geq 30\text{pF} : Q \geq 350$ $10\text{pF} \leq C < 30\text{pF} : Q \geq 275 + \frac{5}{2} C$ $C < 10\text{pF} : Q \geq 200 + 10C$														
I.R.	1,000M Ω min.														
Dielectric Strength	No failure														

Table A-6

Char.	Nominal Values (ppm/ $^{\circ}$ C) Note 1	Capacitance Change from 25 $^{\circ}$ C (%)					
		-55		-30		-10	
		Max.	Min.	Max.	Min.	Max.	Min.
5C	0 \pm 30	0.58	-0.24	0.40	-0.17	0.25	-0.11

Note 1: Nominal values denote the temperature coefficient within a range of 25 to 125 $^{\circ}$ C (for 5C)

ERB Series Data

Q - Frequency Characteristics

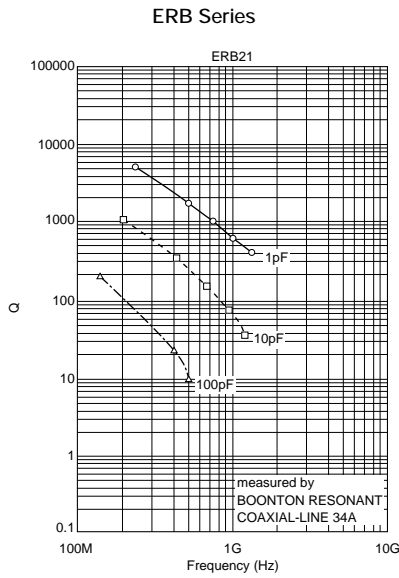

Impedance - Frequency Characteristics

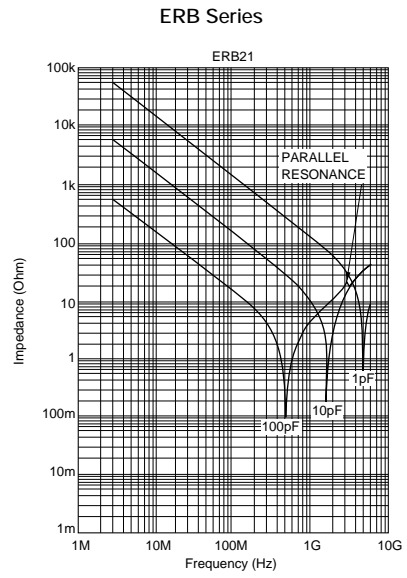

ESR - Frequency Characteristics

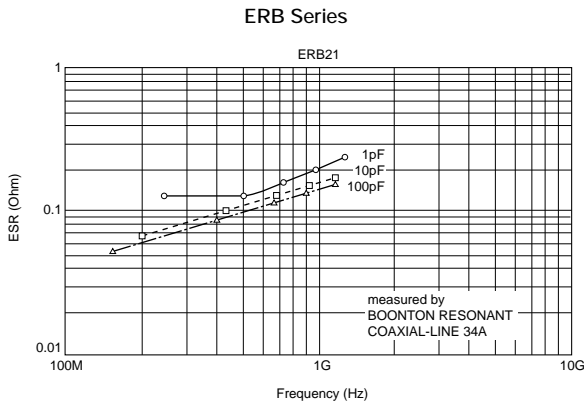

Resonant Frequency - Capacitance

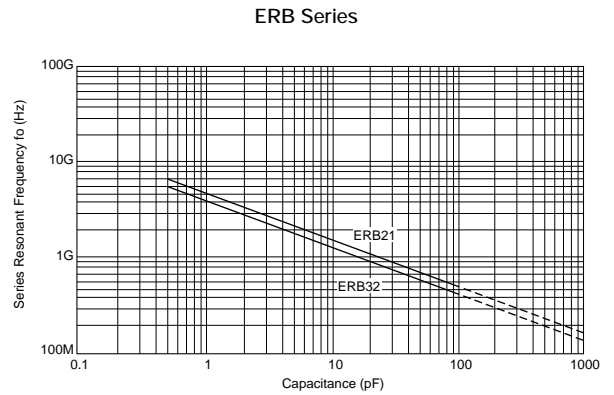

Allowable Voltage - Frequency

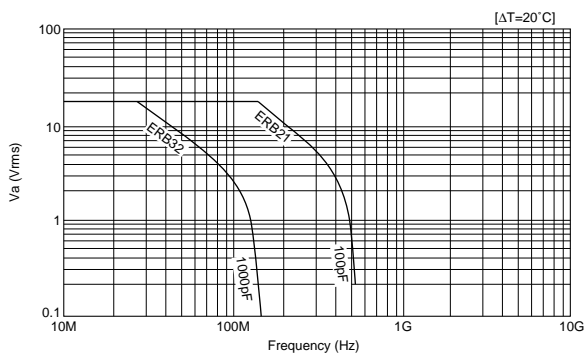

Allowable Current - Frequency

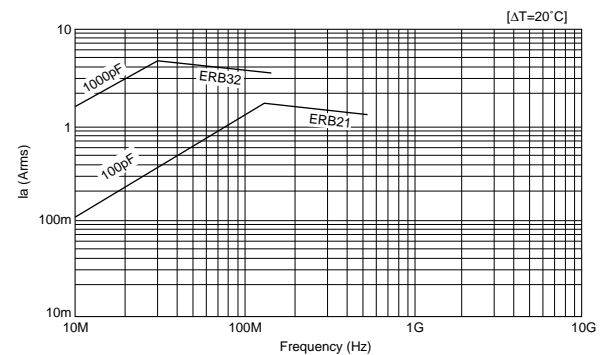

Continued on the following page.

ERB Series Data

Continued from the preceding page.

■ Allowable Apparent Power - Frequency

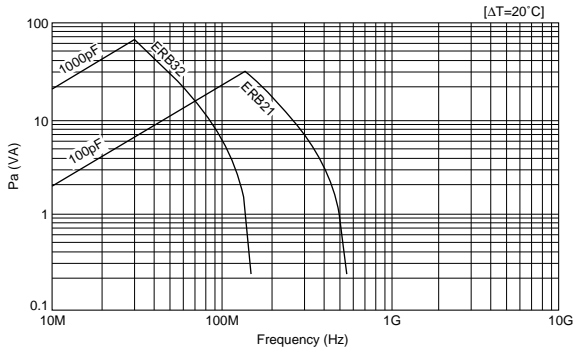

■ Allowable Effective Power - Frequency

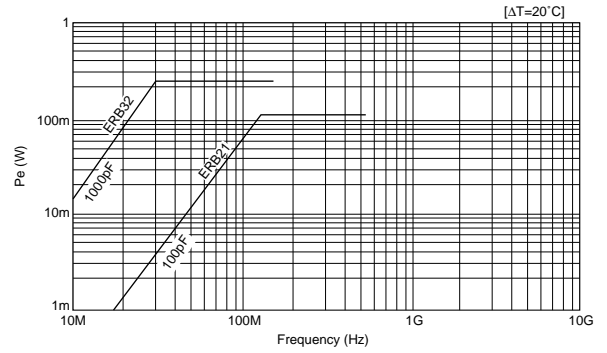

Package

■ Minimum Quantity Guide

Part Number	Dimensions (mm)			Quantity (pcs.)							
				ø180mm Reel		ø330mm Reel		Bulk Case	Bulk Bag		
	L	W	T	Paper Tape	Embossed Tape	Paper Tape	Embossed Tape				
Packaging Code				D	L	J	K	C	Bulk : B Tray : T		
For General Purpose	GRM02	0.4	0.2	0.2	20,000	-	-	-	-	1,000	
	GRM03	0.6	0.3	0.3	15,000	-	50,000	-	-	1,000	
	GRM15	1.0	0.5	0.25	10,000	-	50,000	-	-	1,000	
				0.5	10,000	-	50,000	-	50,000	1,000	
	GRM18	1.6	0.8	0.8	4,000	-	10,000	-	15,000 ¹⁾	1,000	
	GRM21	2.0	1.25	0.6	4,000	-	10,000	-	10,000	1,000	
				0.85/1.0	4,000	-	10,000	-	-	1,000	
	GRM31	3.2	1.6	1.25	-	3,000	-	10,000	5,000 ²⁾	1,000	
				0.6/0.85	4,000	-	10,000	-	-	1,000	
				1.15	-	3,000	-	10,000	-	1,000	
	GRM32	3.2	2.5	1.6	-	2,000	-	6,000	-	1,000	
				0.85	-	4,000	-	10,000	-	1,000	
				1.15	-	3,000	-	10,000	-	1,000	
				1.35	-	2,000	-	8,000	-	1,000	
	GRM43	4.5	3.2	1.6	-	2,000	-	6,000	-	1,000	
				1.8/2.0	-	1,000	-	4,000	-	1,000	
				2.5	-	1,000	-	4,000	-	1,000	
				1.15	-	1,000	-	5,000	-	1,000	
	GRM55	5.7	5.0	1.35/1.6	-	1,000	-	4,000	-	1,000	
				1.8/2.0	-	1,000	-	4,000	-	1,000	
				2.5	-	500	-	2,000	-	1,000	
				2.8	-	500	-	1,500	-	500	
	High Power Type	GJM03	0.6	0.3	0.3	15,000	-	50,000	-	-	1,000
		GJM15	1.0	0.5	0.5	10,000	-	50,000	-	50,000	1,000
High Frequency		GQM18	1.6	0.8	0.8	4,000	-	10,000	-	-	1,000
	GQM21	2.0	1.25	0.85	4,000	-	10,000	-	-	1,000	
	ERB18	1.6	0.8	0.9 max.	4,000	-	10,000	-	-	1,000	
	ERB21	2.0	1.25	1.35 max.	-	3,000	-	10,000	-	1,000	
	ERB32	3.2	2.5	1.7 max.	-	2,000	-	8,000	-	1,000	
	For Ultrasonic	GRM21	2.0	1.25	0.85	4,000	-	10,000	-	-	1,000
Microchip	GMA05	0.5	0.5	0.35	-	-	-	-	-	400 ³⁾	
	GMA08	0.8	0.8	0.5	-	-	-	-	-	400 ³⁾	
Array	GNM1M	1.37	1.0	0.6	4,000	-	10,000	-	-	1,000	
	GNM21	2.0	1.25	0.6/0.85	4,000	-	10,000	-	-	1,000	
				0.8	4,000	-	10,000	-	-	1,000	
Low ESL	LLL15	0.5	1.0	0.3	10,000	-	50,000	-	-	1,000	
				1.0	-	3,000	-	10,000	-	-	1,000
	LLL18	0.8	1.6	0.5	-	4,000	-	10,000	-	1,000	
				0.5/0.6	-	4,000	-	10,000	-	1,000	
	LLL21	1.25	2.0	0.85	-	3,000	-	10,000	-	1,000	
				0.5/0.7	-	4,000	-	10,000	-	1,000	
	LLL31	1.6	3.2	1.15	-	3,000	-	10,000	-	1,000	
				0.5	-	4,000	-	10,000	-	1,000	
	LLA18	1.6	0.8	0.5	-	4,000	-	10,000	-	1,000	
				0.5	-	4,000	-	10,000	-	1,000	
	LLA21	2.0	1.25	0.85	-	3,000	-	10,000	-	1,000	
				0.5	-	4,000	-	10,000	-	1,000	
				0.85	-	3,000	-	10,000	-	1,000	
	LLA31	3.2	1.6	0.5	-	4,000	-	10,000	-	1,000	
				1.15	-	3,000	-	10,000	-	1,000	
LLM21	2.0	1.25	0.5	-	4,000	-	10,000	-	1,000		
			0.85	-	3,000	-	10,000	-	1,000		
LLM31	3.2	1.6	0.5	-	4,000	-	10,000	-	1,000		
			1.15	-	3,000	-	10,000	-	1,000		

- 1) 68,000pF/0.1μF of 50V R7 rated are not available by bulk case.
 2) Dimension tolerance ±0.15mm rated are not available by bulk case.
 3) Tray

Continued on the following page. 

Package

Continued from the preceding page.

(3) Dimensions of Embossed Tape

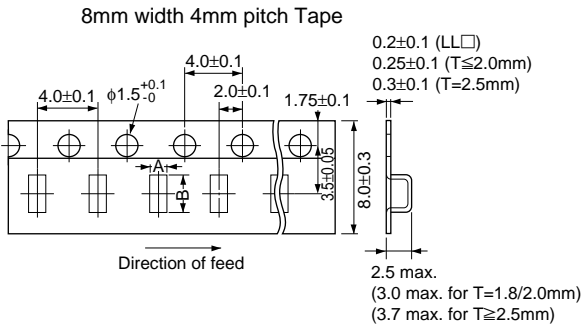

Part Number	A	B
LLL18, LLA18	1.05±0.1	1.85±0.1
GRM21, ERB21 (T≥1.0mm) LLL21 LLA21, LLM21	1.45±0.2	2.25±0.2
GRM31 (T≥1.15mm) LLL31 LLA31, LLM31 GJM31 (T≥1.0mm)	1.9±0.2	3.5±0.2
GRM32, ERB32 (T≥1.0mm)	2.8±0.2	3.5±0.2

*Nominal Value

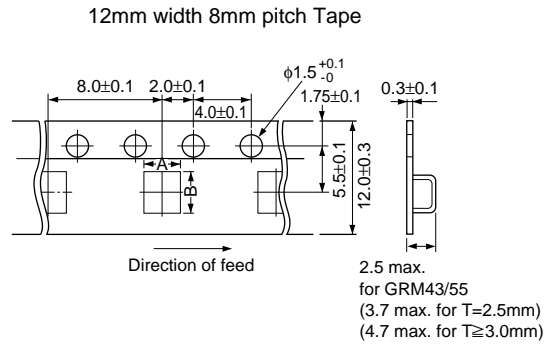

Part Number	A*	B*
GRM43	3.6	4.9
GRM55	5.2	6.1

*Nominal Value

(in mm)

(4) Taping Method

- Tapes for capacitors are wound clockwise. The sprocket holes are to the right as the tape is pulled toward the user.
- Part of the leader and part of the empty tape should be attached to the end of the tape as follows.
- The top tape and base tape are not attached at the end of the tape for a minimum of 5 pitches.
- Missing capacitors number within 0.1% of the number per reel or 1 pc, whichever is greater, and are not continuous.
- The top tape and bottom tape should not protrude beyond the edges of the tape and should not cover sprocket holes.
- Cumulative tolerance of sprocket holes, 10 pitches: ±0.3mm.
- Peeling off force: 0.1 to 0.6N* in the direction shown below.

*GRM02
GRM03 } : 0.05 to 0.5N
GJM03 }

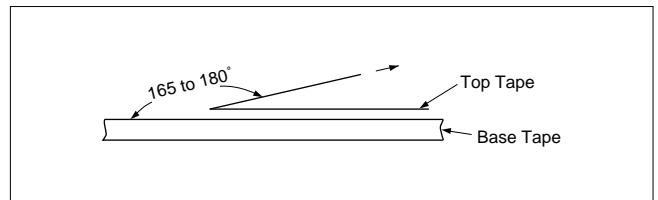
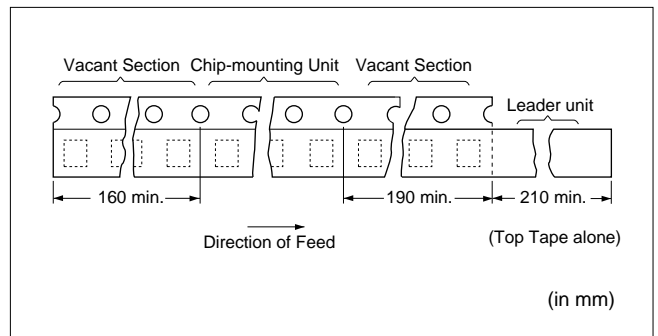

Continued on the following page. ↗

Package

☐ Continued from the preceding page.

■ Dimensions of Bulk Case Packaging

The bulk case uses antistatic materials. Please contact Murata for details.

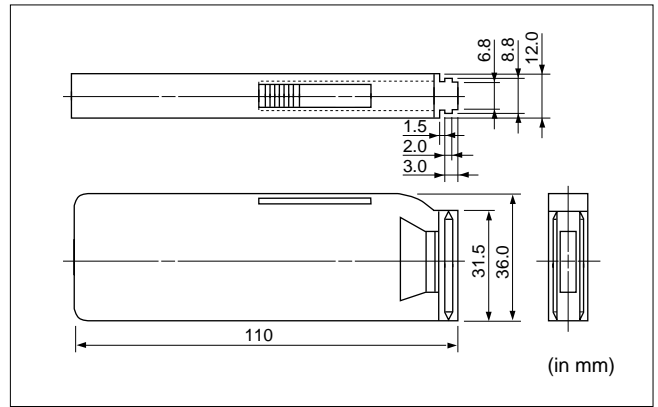

⚠ Caution

■ Storage and Operating Conditions

Chip monolithic ceramic capacitors (chips) can experience degradation of termination solderability when subjected to high temperature or humidity, or if exposed to sulfur or chlorine gases.

Storage environment must be at an ambient temperature of 5-40 degree C and an ambient humidity of 20-70%RH. Use chip within 6 months. If 6 months or more have elapsed, check solderability before use.

Use of Sn-Zn based solder will deteriorate reliability of MLCC.

Please contact Murata factory for the use of Sn-Zn based solder in advance.

FAILURE TO FOLLOW THE ABOVE CAUTIONS MAY RESULT, WORST CASE, IN A SHORT CIRCUIT AND CAUSE FUMING OR PARTIAL DISPERSION WHEN THE PRODUCT IS USED.

■ Handling

1. Inspection

Thrusting force of the test probe can flex the PCB, resulting in cracked chips or open solder joints.

Provide support pins on the back side of the PCB to prevent warping or flexing.

2. Board Separation (or depanelization)

(1) Board flexing at the time of separation causes cracked chips or broken solder.

(2) Severity of stresses imposed on the chip at the time of board break is in the order of:

Pushback<Slitter<V Slot<Perforator.

(3) Board separation must be performed using special jigs, not with hands.

3. Reel and bulk case

In the handling of reel and case, please be careful and do not drop it.

Do not use chips from a case which has been dropped.

FAILURE TO FOLLOW THE ABOVE CAUTIONS MAY RESULT, WORST CASE, IN A SHORT CIRCUIT AND FUMING WHEN THE PRODUCT IS USED.

⚠Caution

■ **⚠Caution (Soldering and Mounting)**

1. Mounting Position

Choose a mounting position that minimizes the stress imposed on the chip during flexing or bending of the board.

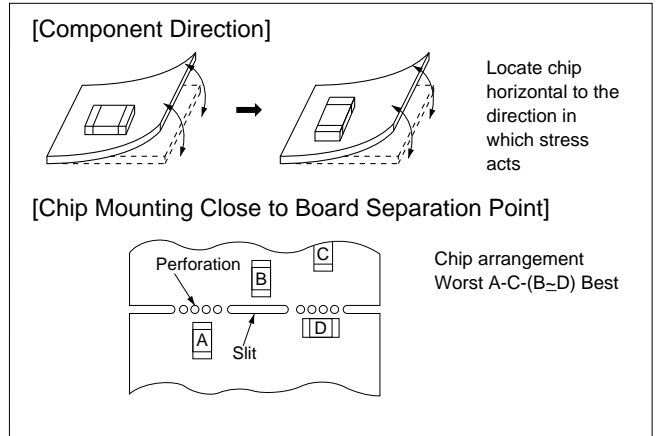

(Reference Data 2. Board bending strength for solder fillet height)
 (Reference Data 3. Temperature cycling for solder fillet height)
 (Reference Data 4. Board bending strength for board material)

2. Chip Placing

- An excessively low bottom dead point of the suction nozzle imposes great force on the chip during mounting, causing cracked chips. So adjust the suction nozzle's bottom dead point by correcting warp in the board. Normally, the suction nozzle's bottom dead point must be set on the upper surface of the board. Nozzle pressure for chip mounting must be a 1 to 3N static load.
- Dirt particles and dust accumulated between the suction nozzle and the cylinder inner wall prevent the nozzle from moving smoothly. This imposes great force on the chip during mounting, causing cracked chips. And the locating claw, when worn out, imposes uneven forces on the chip when positioning, causing cracked chips. The suction nozzle and the locating claw must be maintained, checked and replaced periodically.

(Reference Data 5. Break strength)

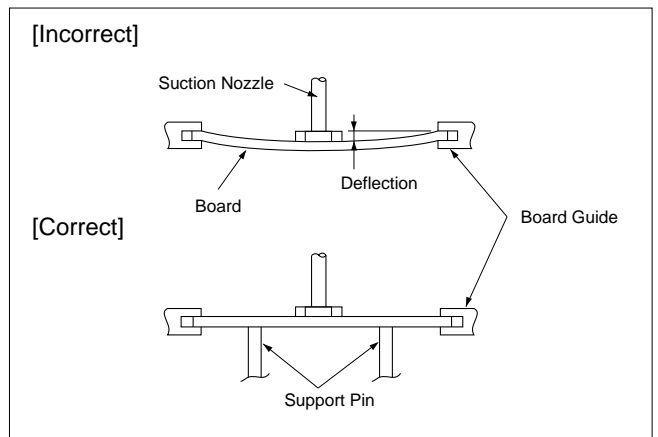

Continued on the following page. ↗

Caution

Continued from the preceding page.

3. Reflow Soldering

- When sudden heat is applied to the components, the mechanical strength of the components should go down because remarkable temperature change causes deformity inside components. In order to prevent mechanical damage in the components, preheating should be required for both of the components and the PCB board. Preheating conditions are shown in table 1. It is required to keep temperature differential between the soldering and the components surface (ΔT) as small as possible.
- Solderability of Tin plating termination chip might be deteriorated when low temperature soldering profile where peak solder temperature is below the Tin melting point is used. Please confirm the solderability of Tin plating termination chip before use.
- When components are immersed in solvent after mounting, be sure to maintain the temperature difference (ΔT) between the component and solvent within the range shown in the table 1.

Table 1

Part Number	Temperature Differential
GRM02/03/15/18/21/31 GJM03/15 LLL15/18/21/31 ERB18/21 GQM18/21	$\Delta T \leq 190^\circ\text{C}$
GRM32/43/55 LLA18/21/31 LLM21/31 GNM ERB32	$\Delta T \leq 130^\circ\text{C}$

Recommended Conditions

	Pb-Sn Solder		Lead Free Solder
	Infrared Reflow	Vapor Reflow	
Peak Temperature	230-250°C	230-240°C	240-260°C
Atmosphere	Air	Air	Air or N ₂

Pb-Sn Solder: Sn-37Pb

Lead Free Solder: Sn-3.0Ag-0.5Cu

● Optimum Solder Amount for Reflow Soldering

- Overly thick application of solder paste results in excessive fillet height solder. This makes the chip more susceptible to mechanical and thermal stress on the board and may cause cracked chips.
- Too little solder paste results in a lack of adhesive strength on the outer electrode, which may result in chips breaking loose from the PCB.
- Make sure the solder has been applied smoothly to the end surface to a height of 0.2mm min.

Inverting the PCB

Make sure not to impose an abnormal mechanical shock on the PCB.

[Standard Conditions for Reflow Soldering]

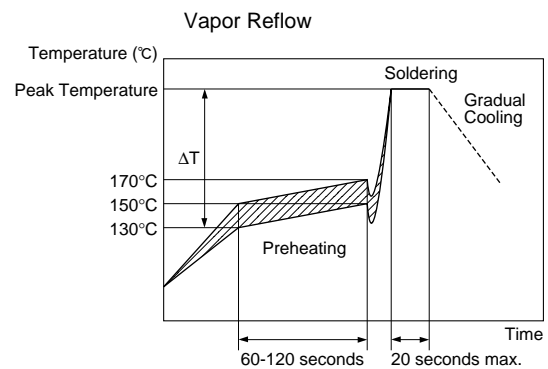
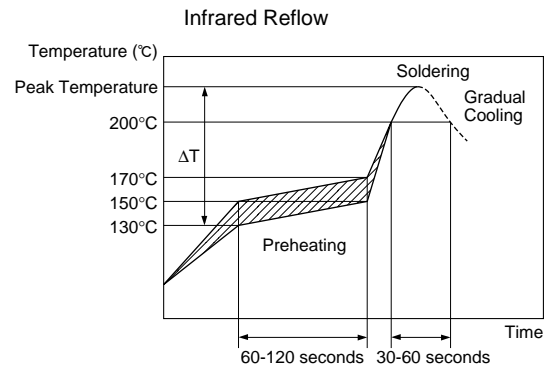

[Allowable Soldering Temperature and Time]

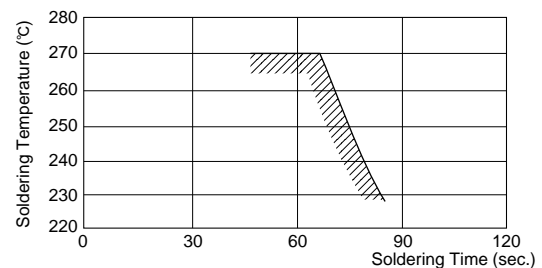

In case of repeated soldering, the accumulated soldering time must be within the range shown above.

[Optimum Solder Amount for Reflow Soldering]

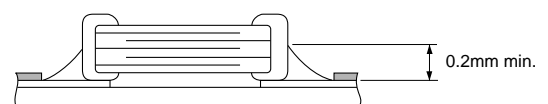



Continued from the preceding page.

4. Leaded Component Insertion

If the PCB is flexed when leaded components (such as transformers and ICs) are being mounted, chips may crack and solder joints may break.

Before mounting leaded components, support the PCB using backup pins or special jigs to prevent warping.

5. Flow Soldering

● When sudden heat is applied to the components, the mechanical strength of the components should go down because remarkable temperature change causes deformity inside components. And an excessively long soldering time or high soldering temperature results in leaching of the outer electrodes, causing poor adhesion or a reduction in capacitance value due to loss of contact between electrodes and end termination.

● In order to prevent mechanical damage in the components, preheating should be required for the both components and the PCB board. Preheating conditions are shown in table 2. It is required to keep temperature differential between the soldering and the components surface (ΔT) as small as possible.

When components are immersed in solvent after mounting, be sure to maintain the temperature difference between the component and solvent within the range shown in Table 2.

Do not apply flow soldering to chips not listed in Table 2.

Table 2

Part Number	Temperature Differential
GRM18/21/31	$\Delta T \leq 150^\circ\text{C}$
LLL21/31	
ERB18/21	
GQM18/21	

Recommended Conditions

	Pb-Sn Solder	Lead Free Solder
Peak Temperature	240-250°C	250-260°C
Atmosphere	Air	N ₂

Pb-Sn Solder: Sn-37Pb

Lead Free Solder: Sn-3.0Ag-0.5Cu

● Optimum Solder Amount for Flow Soldering

The top of the solder fillet should be lower than the thickness of components. If the solder amount is excessively big, the risk of cracking is higher during board bending or under any other stressful conditions.

[Standard Conditions for Flow Soldering]

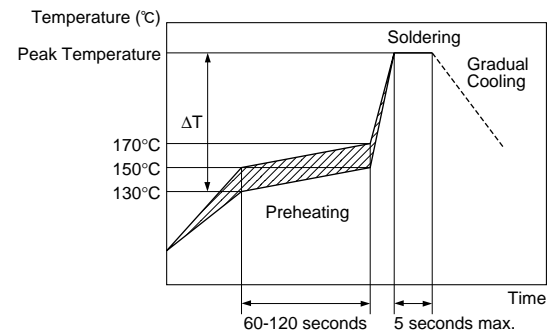

[Allowable Soldering Temperature and Time]

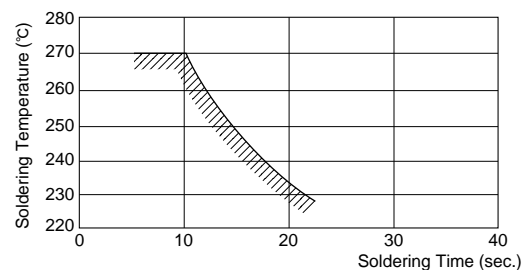

In case of repeated soldering, the accumulated soldering time must be within the range shown above.

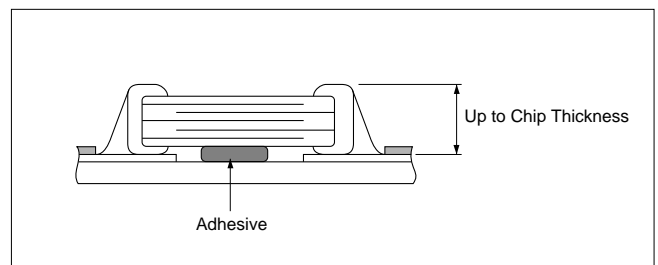

Continued on the following page. ↗

⚠ Caution

☒ Continued from the preceding page.

6. Correction with a Soldering Iron

(1) For Chip Type Capacitors

- When sudden heat is applied to the components by soldering iron, the mechanical strength of the components should go down because remarkable temperature change causes deformity inside components. In order to prevent mechanical damage in the components, preheating should be required for both of the components and the PCB board. Preheating conditions are shown in table 3. It is required to keep temperature differential between the soldering and the components surface (ΔT) as small as possible. After soldering, it is not allowed to cool it down rapidly.

Table 3

Part Number	Temperature Differential	Peak Temperature	Atmosphere
GRM15/18/21/31 GJM15 LLL15/18/21/31 GQM18/21 ERB18/21	$\Delta T \leq 190^\circ\text{C}$	300°C max. 3 seconds max. / termination	Air
GRM32/43/55 GNM LLA18/21/31 LLM21/31 ERB32	$\Delta T \leq 130^\circ\text{C}$	270°C max. 3 seconds max. / termination	Air

*Applicable for both Pb-Sn and Lead Free Solder.

Pb-Sn Solder: Sn-37Pb

Lead Free Solder: Sn-3.0Ag-0.5Cu

- Optimum Solder Amount when Corrections Are Made Using a Soldering Iron

The top of the solder fillet should be lower than the thickness of components. If the solder amount is excessively big, the risk of cracking is higher during board bending or under any other stressful conditions. Soldering iron $\phi 3\text{mm}$ or smaller should be required. And it is necessary to keep a distance between the soldering iron and the components without direct touch. Thread solder with $\phi 0.5\text{mm}$ or smaller is required for soldering.

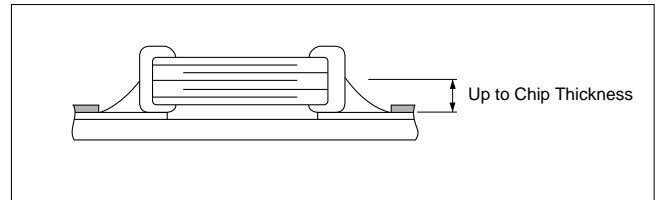

7. Washing

Excessive output of ultrasonic oscillation during cleaning causes PCBs to resonate, resulting in cracked chips or broken solder. Take note not to vibrate PCBs.

FAILURE TO FOLLOW THE ABOVE CAUTIONS MAY RESULT, WORST CASE, IN A SHORT CIRCUIT AND FUMING WHEN THE PRODUCT IS USED.

Notice

■ Rating

Die Bonding/Wire Bonding (GMA Series)

1. Die Bonding of Capacitors

- Use the following materials Brazing alloy:
Au-Sn (80/20) 300 to 320 degree C in N₂ atmosphere
- Mounting
 - (1) Control the temperature of the substrate so that it matches the temperature of the brazing alloy.
 - (2) Place brazing alloy on substrate and place the capacitor on the alloy. Hold the capacitor and gently apply the load. Be sure to complete the operation in 1 minute.

2. Wire Bonding

- Wire
 - Gold wire:
20 micro m (0.0008 inch), 25 micro m (0.001 inch) diameter
- Bonding
 - (1) Thermocompression, ultrasonic ball bonding.
 - (2) Required stage temperature : 200 to 250 degree C
 - (3) Required wedge or capillary weight : 0.5N to 2N.
 - (4) Bond the capacitor and base substrate or other devices with gold wire.

Notice

■ Notice (Soldering and Mounting)

1. PCB Design

(1) Notice for Pattern Forms

Unlike leaded components, chip components are susceptible to flexing stresses since they are mounted directly on the substrate.

They are also more sensitive to mechanical and thermal stresses than leaded components.

Excess solder fillet height can multiply these stresses and cause chip cracking. When designing substrates, take land patterns and dimensions into consideration to eliminate the possibility of excess solder fillet height.

Pattern Forms

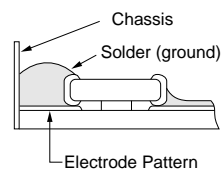
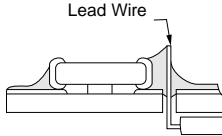
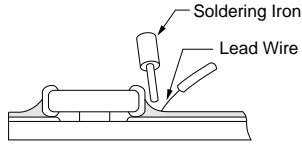
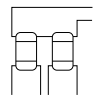
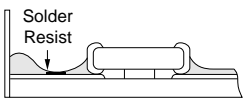
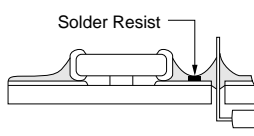
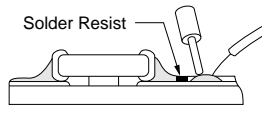
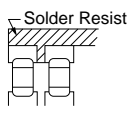
	Placing Close to Chassis	Placing of Chip Components and Leaded Components	Placing of Leaded Components after Chip Component	Lateral Mounting
Prohibited				
Correct				

Continued on the following page. 

Notice

Continued from the preceding page.

(2) Land Dimensions

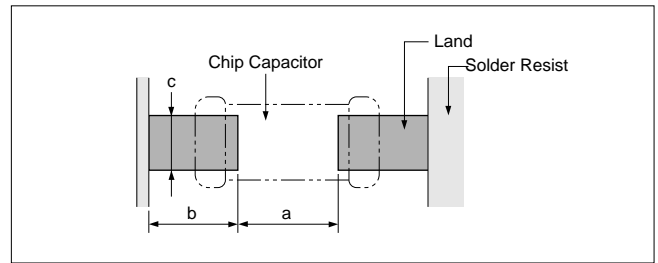

Table 1 Flow Soldering Method

Part Number	Dimensions	Dimensions (L×W)	a	b	c
GRM18 GQM18		1.6×0.8	0.6–1.0	0.8–0.9	0.6–0.8
GRM21 GQM21		2.0×1.25	1.0–1.2	0.9–1.0	0.8–1.1
GRM31		3.2×1.6	2.2–2.6	1.0–1.1	1.0–1.4
LLL21		1.25×2.0	0.4–0.7	0.5–0.7	1.4–1.8
LLL31		1.6×3.2	0.6–1.0	0.8–0.9	2.6–2.8
ERB18		1.6×0.8	0.6–1.0	0.8–0.9	0.6–0.8
ERB21		2.0×1.25	1.0–1.2	0.9–1.0	0.8–1.1

(in mm)

Table 2 Reflow Soldering Method

Part Number	Dimensions	Dimensions (L×W)	a	b	c
GRM02		0.4×0.2	0.16–0.2	0.12–0.18	0.2–0.23
GRM03 GJM03		0.6×0.3	0.2–0.3	0.2–0.35	0.2–0.4
GRM15 GJM15		1.0×0.5	0.3–0.5	0.35–0.45	0.4–0.6
GRM18 GQM18		1.6×0.8	0.6–0.8	0.6–0.7	0.6–0.8
GRM21 GQM21		2.0×1.25	1.0–1.2	0.6–0.7	0.8–1.1
GRM31		3.2×1.6	2.2–2.4	0.8–0.9	1.0–1.4
GRM32		3.2×2.5	2.0–2.4	1.0–1.2	1.8–2.3
GRM43		4.5×3.2	3.0–3.5	1.2–1.4	2.3–3.0
GRM55		5.7×5.0	4.0–4.6	1.4–1.6	3.5–4.8
LLL15		0.5×1.0	0.15–0.2	0.2–0.3	0.7–1.0
LLL18		0.8×1.6	0.2–0.4	0.3–0.4	1.0–1.4
LLL21		1.25×2.0	0.4–0.6	0.3–0.5	1.4–1.8
LLL31		1.6×3.2	0.6–0.8	0.6–0.7	2.6–2.8
ERB18		1.6×0.8	0.6–0.8	0.6–0.7	0.6–0.8
ERB21		2.0×1.25	1.0–1.2	0.6–0.7	0.8–1.1
ERB32		3.2×2.5	2.0–2.4	1.0–1.2	1.8–2.3

(in mm)

Continued on the following page.

Notice

Continued from the preceding page.

● GNM, LLA Series for Reflow Soldering Method

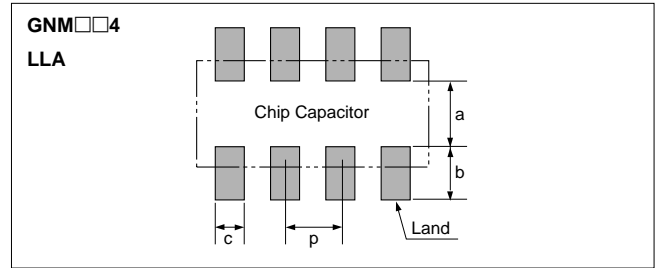
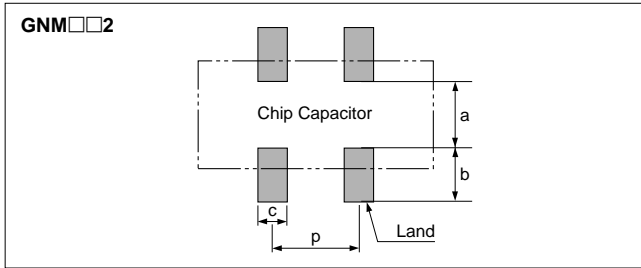

Table 3 GNM, LLA Series for Reflow Soldering Land Dimensions

Part Number	Dimensions (mm)					
	L	W	a	b	c	p
GNM1M2	1.37	1.0	0.4 to 0.5	0.35 to 0.45	0.3 to 0.35	0.64
GNM212	2.0	1.25	0.6 to 0.7	0.5 to 0.7	0.4 to 0.5	1.0
GNM214	2.0	1.25	0.6 to 0.7	0.5 to 0.7	0.25 to 0.35	0.5
GNM314	3.2	1.6	0.8 to 1.0	0.7 to 0.9	0.3 to 0.4	0.8
LLA18	1.6	0.8	0.3 to 0.4	0.25 to 0.4	0.2 to 0.28	0.4
LLA21	2.0	1.25	0.7 to 0.8	0.4 to 0.6	0.2 to 0.3	0.5
LLA31	3.2	1.6	0.8 to 1.0	0.7 to 0.9	0.3 to 0.4	0.8

● LLM Series for Reflow Soldering Method

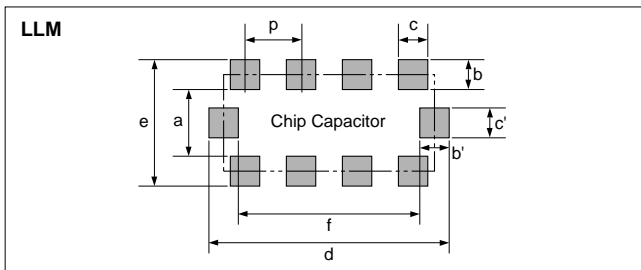

Table 4 LLM Series for Reflow Soldering Land Dimensions

Part Number	Dimensions (mm)						
	a	b, b'	c, c'	d	e	f	p
LLM21	0.6 to 0.8	(0.3 to 0.5)	0.3	2.0 to 2.6	1.3 to 1.8	1.4 to 1.6	0.5
LLM31	1.0	(0.3 to 0.5)	0.4	3.2 to 3.6	1.6 to 2.0	2.6	0.8

$$b=(c-e)/2, b'=(d-f)/2$$

2. Adhesive Application

- Thin or insufficient adhesive causes chips to loosen or become disconnected when flow soldered. The amount of adhesive must be more than dimension c shown in the drawing at right to obtain enough bonding strength. The chip's electrode thickness and land thickness must be taken into consideration.
- Low viscosity adhesive causes chips to slip after mounting. Adhesive must have a viscosity of 5000Pa·s (500ps) min. (at 25°C)
- Adhesive Coverage*

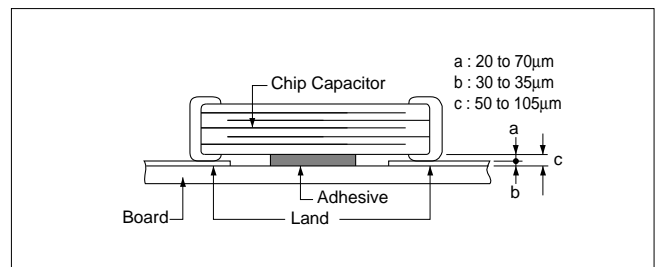

Part Number	Adhesive Coverage*
GRM18, GQM18	0.05mg min.
GRM21, LLL21, GQM21	0.1mg min.
GRM31, LLL31	0.15mg min.

*Nominal Value

Continued on the following page. ↗

Notice

☒ Continued from the preceding page.

3. Adhesive Curing

Insufficient curing of the adhesive causes chips to disconnect during flow soldering and causes deteriorated insulation resistance between outer electrodes due to moisture absorption.

Control curing temperature and time in order to prevent insufficient hardening.

Inverting the PCB

Make sure not to impose an abnormal mechanical shock on the PCB.

4. Flux Application

- An excessive amount of flux generates a large quantity of flux gas, causing deteriorated solderability. So apply flux thinly and evenly throughout. (A foaming system is generally used for flow soldering).
- Flux containing too high a percentage of halide may cause corrosion of the outer electrodes unless sufficiently

cleaned. Use flux with a halide content of 0.2wt% max. But do not use strong acidic flux.

Wash thoroughly because water soluble flux causes deteriorated insulation resistance between outer electrodes unless sufficiently cleaned.

5. Flow Soldering

- Set temperature and time to ensure that leaching of the outer electrode does not exceed 25% of the chip end area as a single chip (full length of the edge A-B-C-D shown below) and 25% of the length A-B shown below as mounted on substrate.

[As a Single Chip]

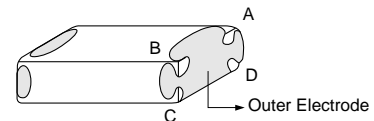

[As Mounted on Substrate]

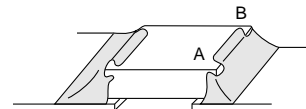

(Reference Data 6. Thermal shock)

(Reference Data 7. Solder heat resistance)

■ Others

1. Resin Coating

When selecting resin materials, select those with low contraction.

2. Circuit Design

These capacitors in this catalog are not safety recognized products

3. Remarks

The above notices are for standard applications and conditions. Contact us when the products are used in special mounting conditions. Select optimum conditions for operation as they determine the reliability of the product after assembly.

The data herein are given in typical values, not guaranteed ratings.

Reference Data

1. Solderability

(1) Test Method

Subject the chip capacitor to the following conditions.
 Then apply flux (an ethanol solution of 25% rosin) to the chip and dip it in 230°C eutectic solder for 2 seconds.

Conditions:

Expose prepared at room temperature (for 6 months and 12 months, respectively)

Prepared at high temperature (for 100 hours at 85°C)

Prepared left at high humidity (for 100 hours under 90%RH to 95%RH at 40°C)

(2) Test Samples

GRM21 : Products for flow/reflow soldering.

(3) Acceptance Criteria

With a 60-power optical microscope, measure the surface area of the outer electrode that is covered with solder.

(4) Results

Refer to Table 1.

Table 1

Sample	Initial State	Prepared at Room Temperature		Prepared at High Temperature for 100 Hours at 85°C	Prepared at High Humidity for 100 Hours at 90 to 95% RH and 40°C
		6 months	12 months		
GRM21 for flow/reflow soldering	95 to 100%	95 to 100%	95%	90 to 95%	95%

2. Board Bending Strength for Solder Fillet Height

(1) Test Method

Solder the chip capacitor to the test PCB with the amount of solder paste necessary to achieve the fillet heights.
 Then bend the PCB using the method illustrated and measure capacitance.

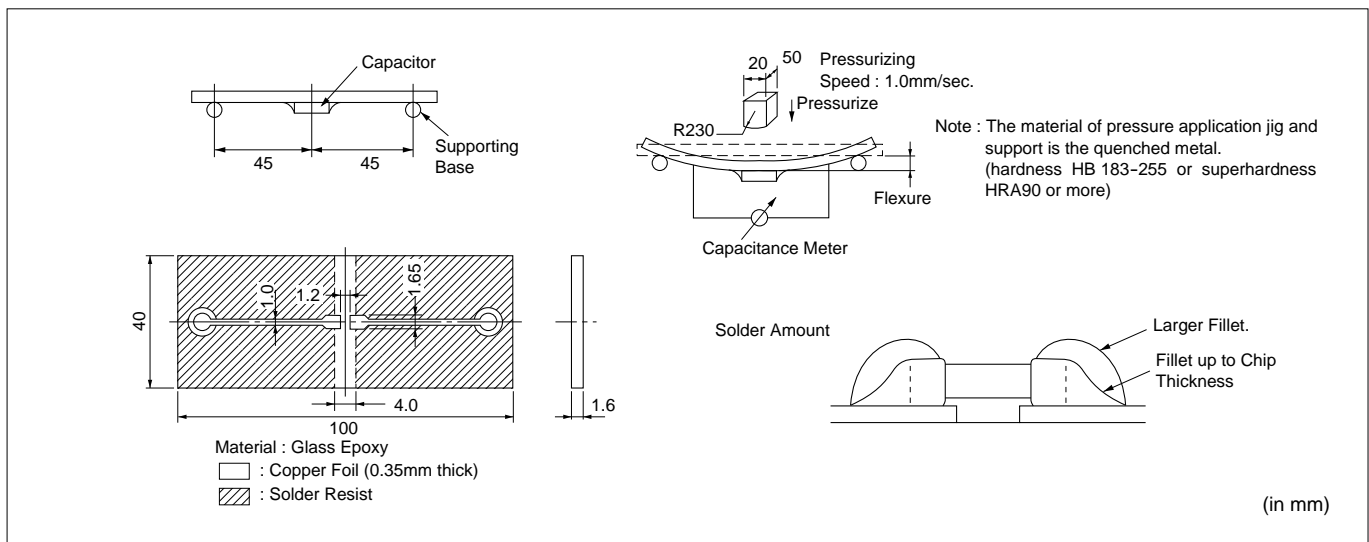

(2) Test Samples

GRM21: 5C/R7/F5 Characteristics T=0.6mm

(3) Acceptance Criteria

Products should be determined to be defective if the change in capacitance has exceeded the values specified in Table 2.

Table 2

Characteristics	Change in Capacitance
5C	Within $\pm 5\%$ or $\pm 0.5\text{pF}$, whichever is greater
R7	Within $\pm 12.5\%$
F5	Within $\pm 20\%$

Continued on the following page.

Reference Data

Continued from the preceding page.

(4) Results

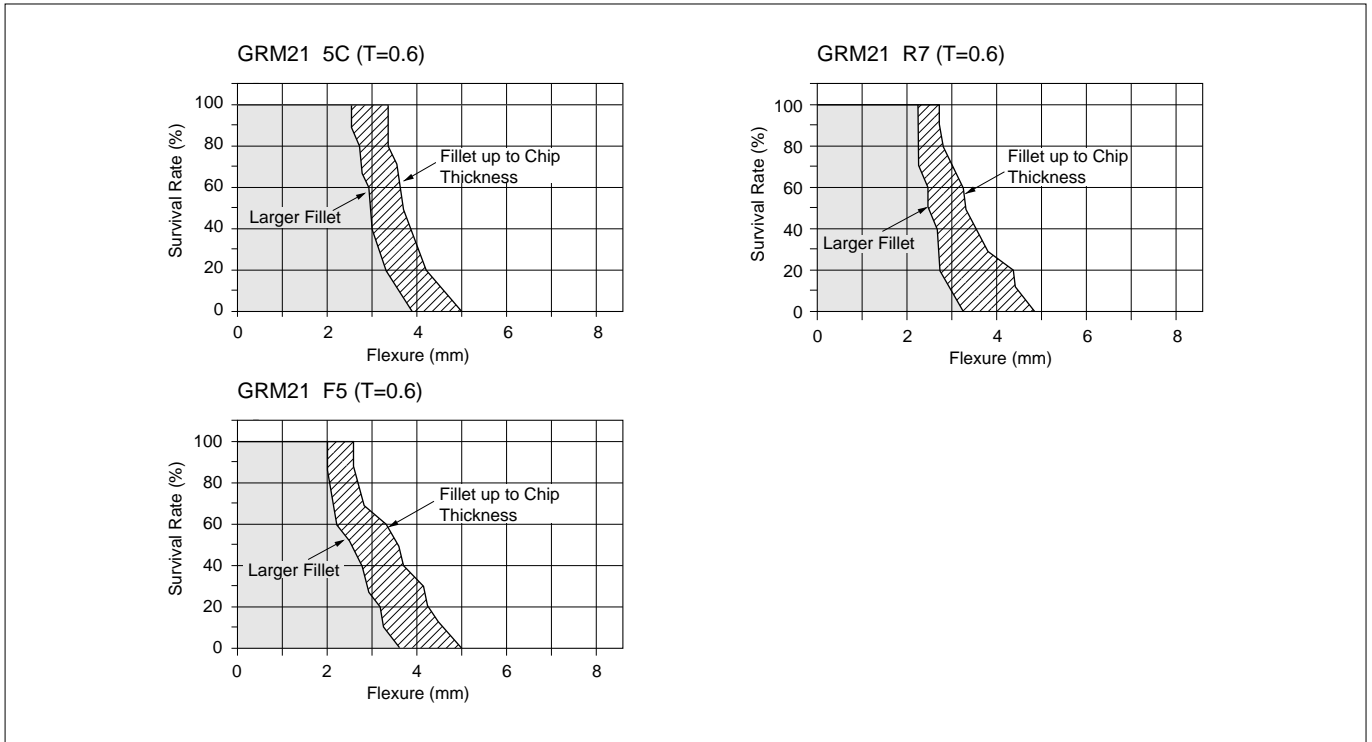

3. Temperature Cycling for Solder Fillet Height

(1) Test Method

Solder the chips to the substrate of various test fixtures using sufficient amounts of solder to achieve the required fillet height. Then subject the fixtures to the cycle illustrated below 200 times.

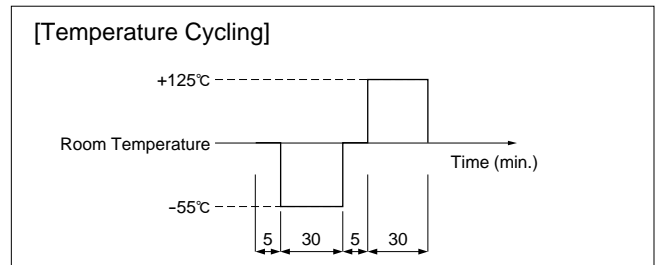

① Solder Amount

Alumina substrates are typically designed for reflow soldering.

Glass epoxy or paper phenol substrates are typically used for flow soldering.

② Material

- Alumina (Thickness: 0.64mm)
- Glass epoxy (Thickness: 1.64mm)
- Paper phenol (Thickness: 1.64mm)

[Solder Amount]		Alumina	Glass Epoxy or Paper Phenol
Solder Amount	①		
	②		
	③		
Solder to be used		6X4 Eutectic solder	

③ Land Dimension

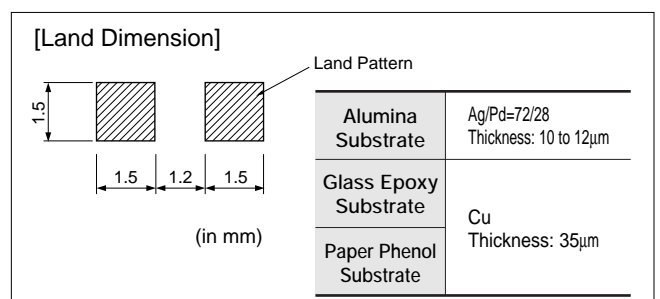

Continued on the following page.

Reference Data

Continued from the preceding page.

(2) Test Samples

GRM21 5C/R7/F5 Characteristics T=0.6mm

(3) Acceptance Criteria

Products are determined to be defective if the change in capacitance has exceeded the values specified in Table 3.

Table 3

Characteristics	Change in Capacitance
5C	Within $\pm 2.5\%$ or $\pm 0.25\text{pF}$, whichever is greater
R7	Within $\pm 7.5\%$
F5	Within $\pm 20\%$

(4) Results

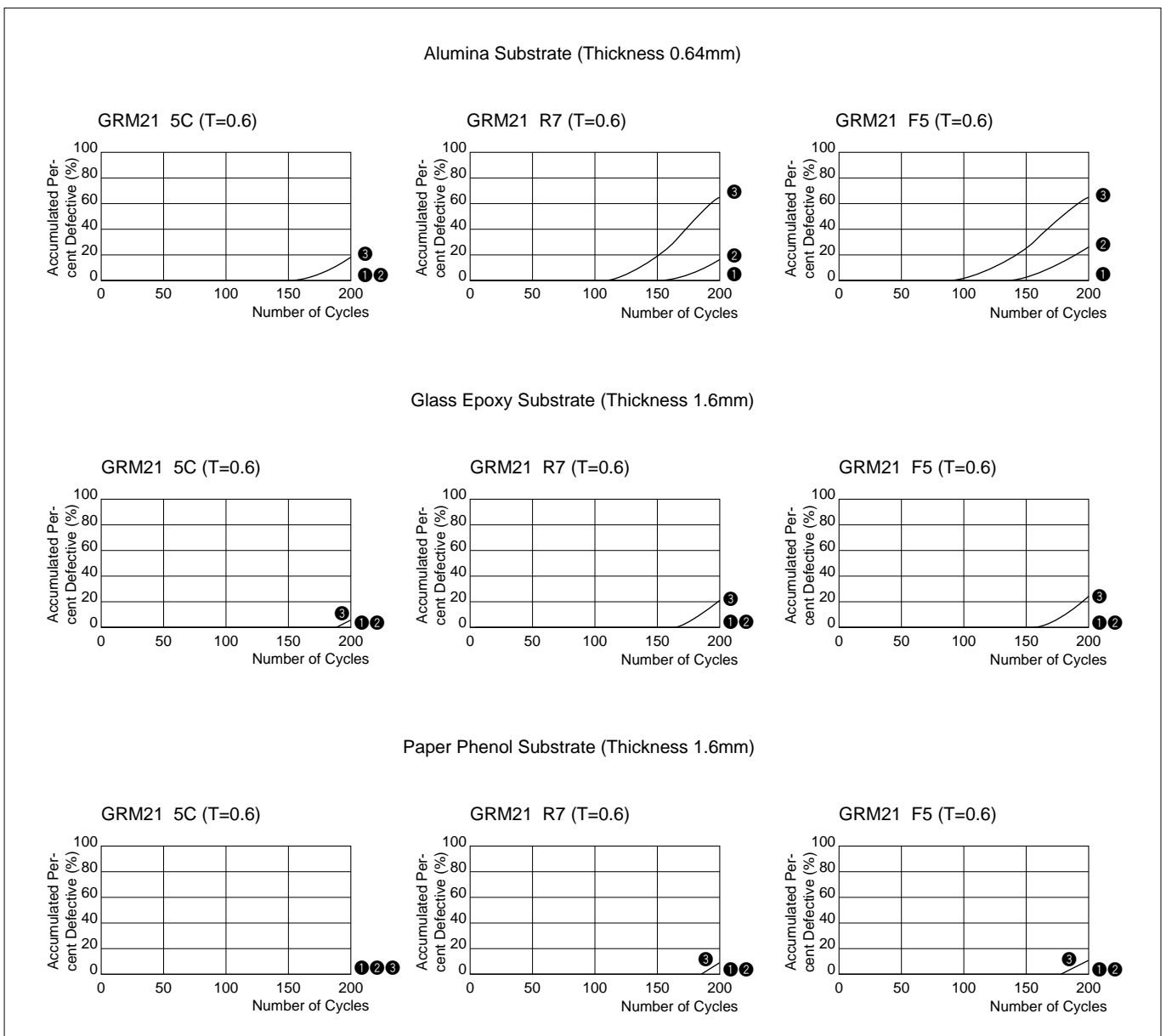

Continued on the following page.

Reference Data

Continued from the preceding page.

4. Board Bending Strength for Board Material

(1) Test Method

Solder the chip to the test board. Then bend the board using the method illustrated below, to measure capacitance.

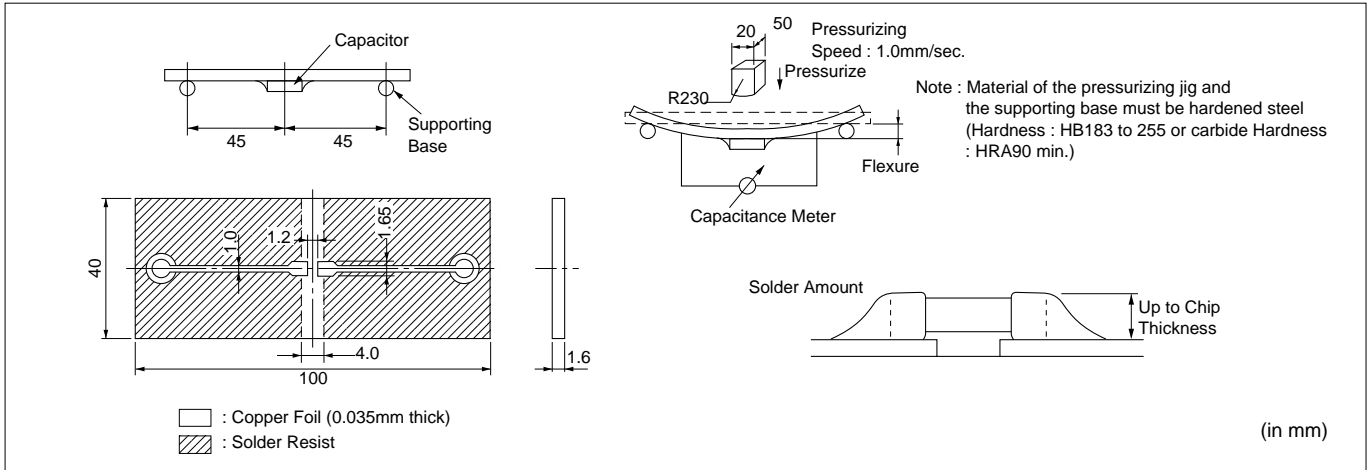

(2) Test Samples

GRM21 5C/R7/F5 Characteristics T=0.6mm typical

(3) Acceptance Criteria

Products should be determined to be defective if the change in capacitance has exceeded the values specified in Table 4.

Table 4

Characteristics	Change in Capacitance
5C	Within $\pm 5\%$ or $\pm 0.5\text{pF}$, whichever is greater
R7	Within $\pm 12.5\%$
F5	Within $\pm 20\%$

(4) Results

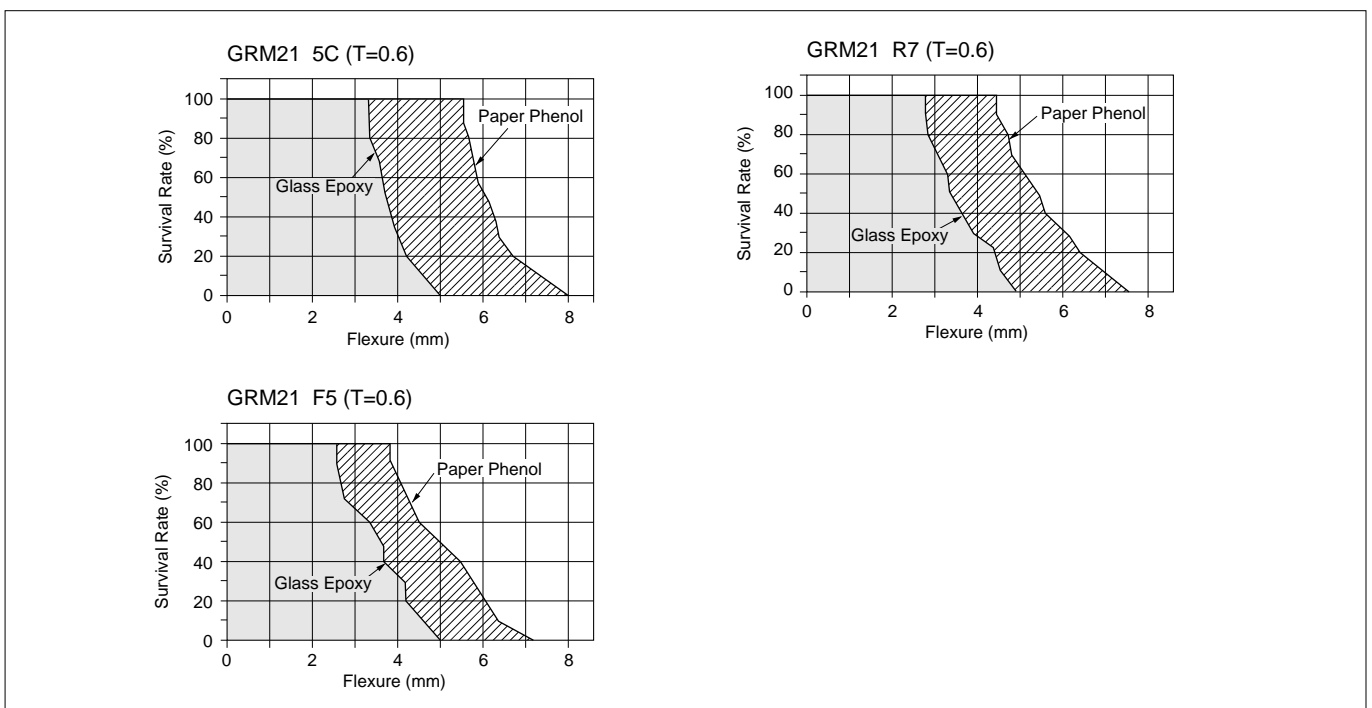

Continued on the following page.

Reference Data

☐ Continued from the preceding page.

5. Break Strength

(1) Test Method

Place the chip on a steel plate as illustrated on the right. Increase load applied to a point near the center of the test sample.

(2) Test Samples

GRM21 5C/R7/F5 Characteristics
 GRM31 5C/R7/F5 Characteristics

(3) Acceptance Criteria

Define the load that has caused the chip to break or crack, as the bending force.

(4) Explanation

Break strength, P, is proportionate to the square of the thickness of the ceramic element and is expressed as a curve of secondary degree.

The formula is:

$$P = \frac{2\gamma WT^2}{3L} \quad (\text{N})$$

W: Width of ceramic element (mm)
 T: Thickness of element (mm)
 L: Distance between fulcrums (mm)
 γ : Bending stress (N/mm²)

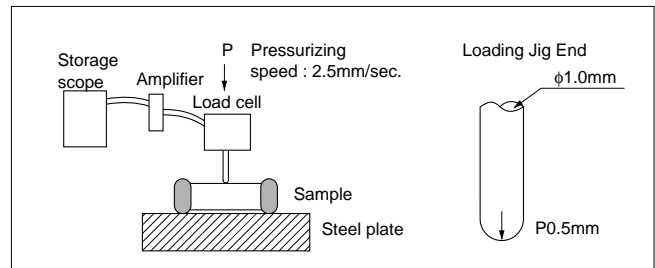

Chip Size	L	W	γ		
			5C Characteristics	R7 Characteristics	F5 Characteristics
GRM21	1.5	1.2	300	180	160
GRM31	2.7	1.5			

(in mm)

(5) Results

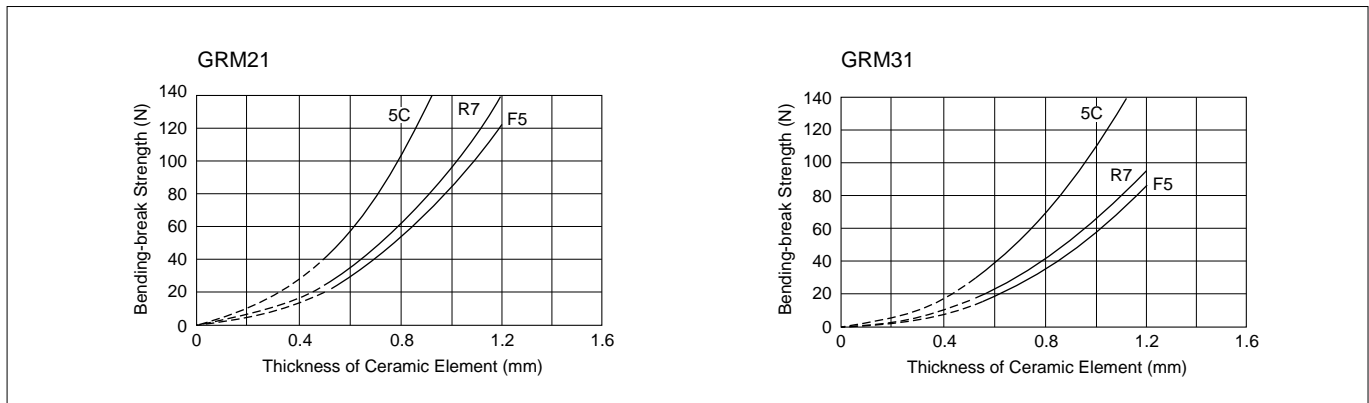

6. Thermal Shock

(1) Test method

After applying flux (an ethanol solution of 25% rosin), dip the chip in a solder bath (6X4 eutectic solder) in accordance with the following conditions:

(2) Test samples

GRM21 5C/R7/F5 Characteristics T=0.6mm typical

(3) Acceptance criteria

Visually inspect the test sample with a 60-power optical microscope. Chips exhibiting breaks or cracks should be determined to be defective.

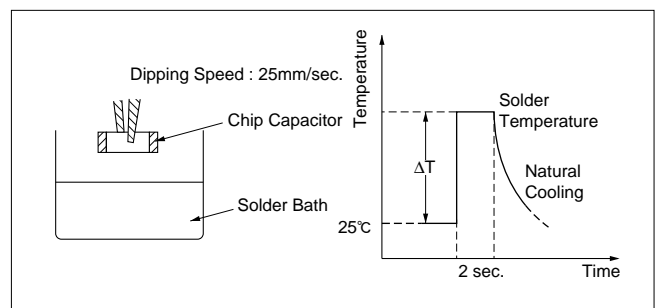

Continued on the following page. ☞

Reference Data

Continued from the preceding page.

(4) Results

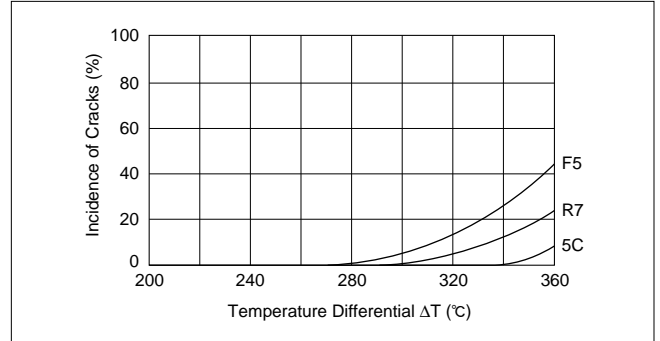

7. Solder Heat Resistance

(1) Test Method

① Reflow soldering:

Apply about 300 μm of solder paste over the alumina substrate. After reflow soldering, remove the chip and check for leaching that may have occurred on the outer electrode.

② Flow soldering:

After dipping the test sample with a pair of tweezers in wave solder (eutectic solder), check for leaching that may have occurred on the outer electrode.

③ Dip soldering:

After dipping the test sample with a pair of tweezers in static solder (eutectic solder), check for leaching that may have occurred on the outer electrode.

④ Flux to be used: An ethanol solution of 25% rosin.

(2) Test samples

GRM21: For flow/reflow soldering T=0.6mm

(3) Acceptance criteria

The starting time of leaching should be defined as the time when the outer electrode has lost 25% of the total edge length of A-B-C-D as illustrated:

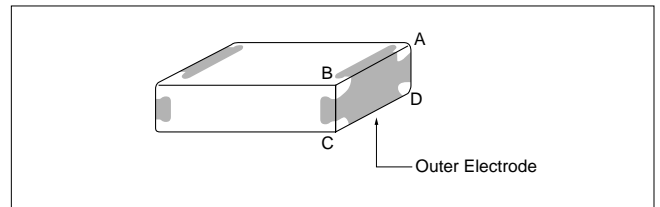

(4) Results

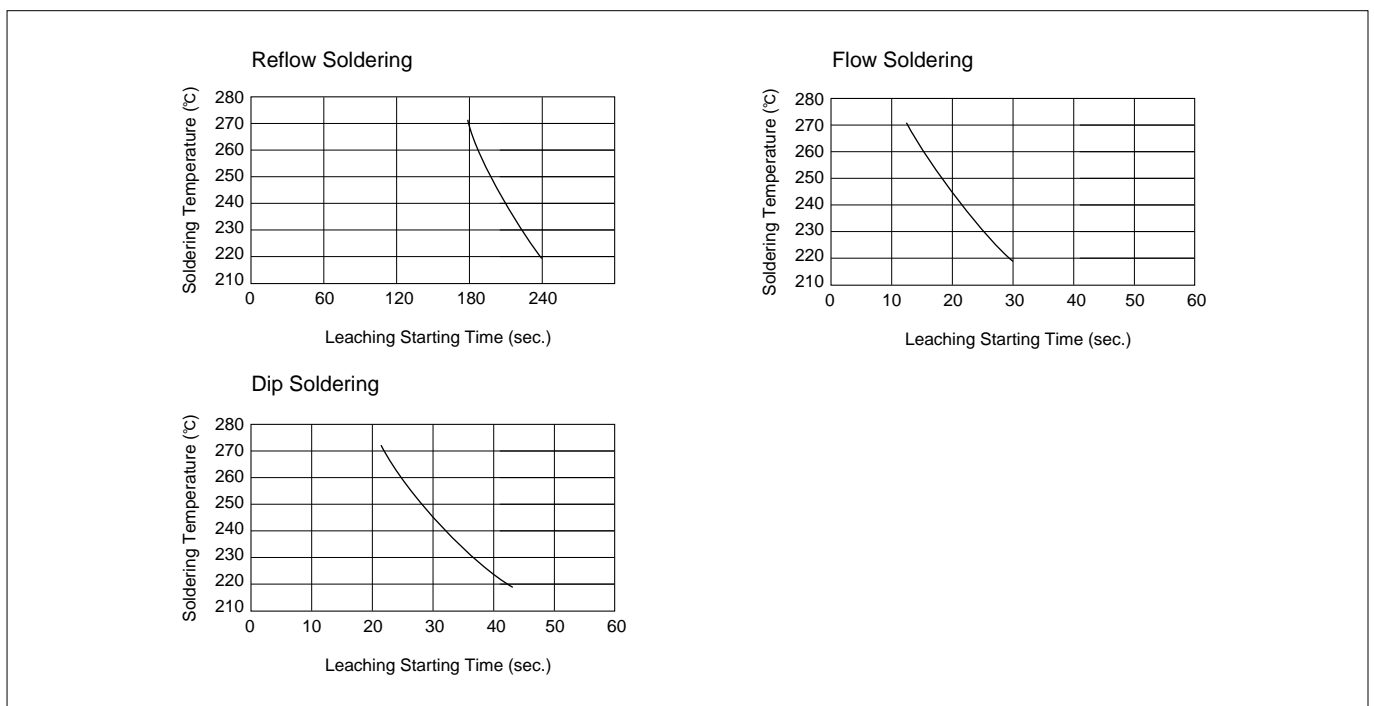

Continued on the following page. ↗

Reference Data

Continued from the preceding page.

8. Thermal Shock when Making Corrections with a Soldering Iron

(1) Test Method

Apply a soldering iron meeting the conditions below to the soldered joint of a chip that has been soldered to a paper phenol board, while supplying wire solder. (Note: the soldering iron tip should not directly touch the ceramic element of the chip.)

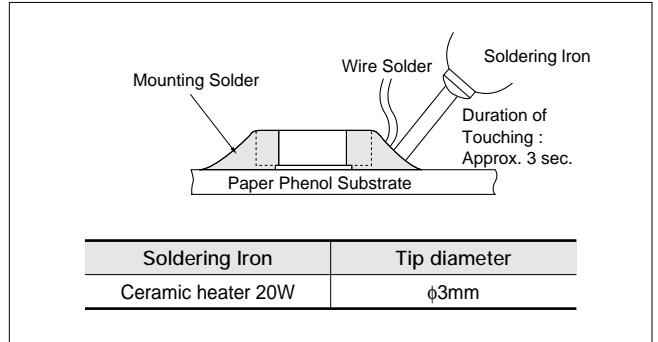

(2) Test Samples

GRM21 5C/R7/F5 Characteristics T=0.6mm

(3) Acceptance Criteria for Defects

Observe the appearance of the test sample with a 60-power optical microscope. Those units displaying any breaks or cracks are determined to be defective.

(4) Results

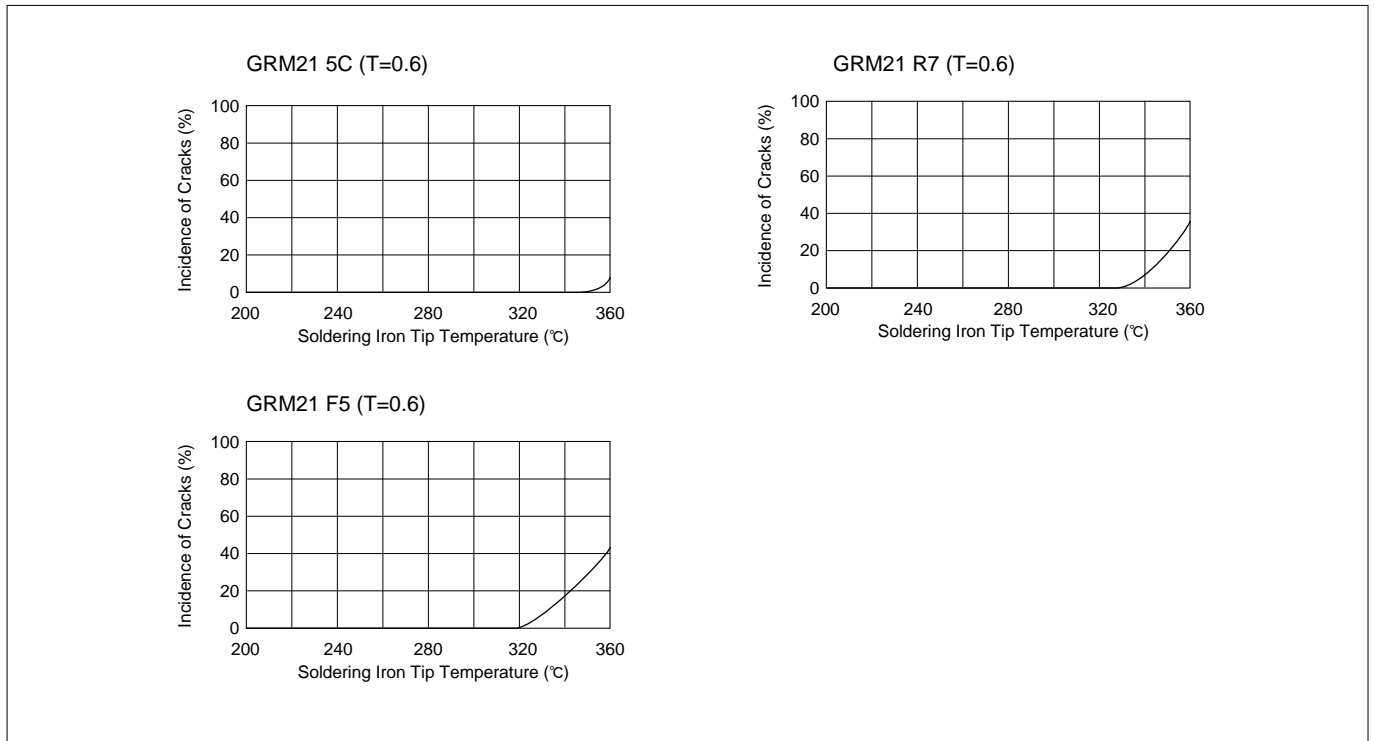

Chip Monolithic Ceramic Capacitors



Medium Voltage Low Dissipation Factor

■ Features

1. Low-loss and suitable for high frequency circuits
2. Murata's original internal electrode structure realizes high flash-over voltage.
3. A new monolithic structure for small, surface-mountable devices capable of operating at high voltage levels
4. Sn-plated external electrodes realize good solderability.
5. Use the GRM21/31 type with flow or reflow soldering, and other types with reflow soldering only.

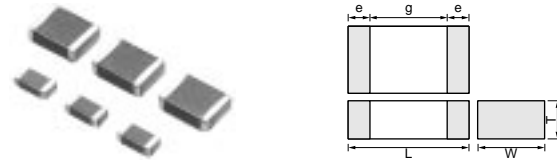

Part Number	Dimensions (mm)				
	L	W	T	e min.	g min.
GRM21A	2.0 ±0.2	1.25 ±0.2	1.0 +0, -0.3	0.3	0.7
GRM31A	3.2 ±0.2	1.6 ±0.2	1.25 +0, -0.3		1.5*
GRM31B			1.0 +0, -0.3		
GRM32A	3.2 ±0.2	2.5 ±0.2	1.25 +0, -0.3		
GRM32B			1.0 +0, -0.3		
GRM42A	4.5 ±0.3	2.0 ±0.2	1.0 +0, -0.3		

* GRM31A7U3D, GRM32A7U3D, GRM32B7U3D : 1.8mm min.

■ Applications

Ideal for use on high frequency pulse circuits such as snubber circuits for switching power supplies, DC-DC converters, ballasts (inverter fluorescent lamps), etc.

Part Number	Rated Voltage (V)	TC Code (Standard)	Capacitance (pF)	Length L (mm)	Width W (mm)	Thickness T (mm)	Electrode g min. (mm)	Electrode e (mm)
GRM21A7U2E101JW31D	DC250	U2J (EIA)	100 ±5%	2.0	1.25	1.0	0.7	0.3 min.
GRM21A7U2E151JW31D	DC250	U2J (EIA)	150 ±5%	2.0	1.25	1.0	0.7	0.3 min.
GRM21A7U2E221JW31D	DC250	U2J (EIA)	220 ±5%	2.0	1.25	1.0	0.7	0.3 min.
GRM21A7U2E331JW31D	DC250	U2J (EIA)	330 ±5%	2.0	1.25	1.0	0.7	0.3 min.
GRM21A7U2E471JW31D	DC250	U2J (EIA)	470 ±5%	2.0	1.25	1.0	0.7	0.3 min.
GRM21A7U2E681JW31D	DC250	U2J (EIA)	680 ±5%	2.0	1.25	1.0	0.7	0.3 min.
GRM21A7U2E102JW31D	DC250	U2J (EIA)	1000 ±5%	2.0	1.25	1.0	0.7	0.3 min.
GRM21A7U2E152JW31D	DC250	U2J (EIA)	1500 ±5%	2.0	1.25	1.0	0.7	0.3 min.
GRM21A7U2E222JW31D	DC250	U2J (EIA)	2200 ±5%	2.0	1.25	1.0	0.7	0.3 min.
GRM31A7U2E332JW31D	DC250	U2J (EIA)	3300 ±5%	3.2	1.6	1.0	1.5	0.3 min.
GRM31A7U2E472JW31D	DC250	U2J (EIA)	4700 ±5%	3.2	1.6	1.0	1.5	0.3 min.
GRM31B7U2E682JW31L	DC250	U2J (EIA)	6800 ±5%	3.2	1.6	1.25	1.5	0.3 min.
GRM31B7U2E103JW31L	DC250	U2J (EIA)	10000 ±5%	3.2	1.6	1.25	1.5	0.3 min.
GRM31A7U2J100JW31D	DC630	U2J (EIA)	10 ±5%	3.2	1.6	1.0	1.5	0.3 min.
GRM31A7U2J150JW31D	DC630	U2J (EIA)	15 ±5%	3.2	1.6	1.0	1.5	0.3 min.
GRM31A7U2J220JW31D	DC630	U2J (EIA)	22 ±5%	3.2	1.6	1.0	1.5	0.3 min.
GRM31A7U2J330JW31D	DC630	U2J (EIA)	33 ±5%	3.2	1.6	1.0	1.5	0.3 min.
GRM31A7U2J470JW31D	DC630	U2J (EIA)	47 ±5%	3.2	1.6	1.0	1.5	0.3 min.
GRM31A7U2J680JW31D	DC630	U2J (EIA)	68 ±5%	3.2	1.6	1.0	1.5	0.3 min.
GRM31A7U2J101JW31D	DC630	U2J (EIA)	100 ±5%	3.2	1.6	1.0	1.5	0.3 min.
GRM31A7U2J151JW31D	DC630	U2J (EIA)	150 ±5%	3.2	1.6	1.0	1.5	0.3 min.
GRM31A7U2J221JW31D	DC630	U2J (EIA)	220 ±5%	3.2	1.6	1.0	1.5	0.3 min.
GRM31A7U2J331JW31D	DC630	U2J (EIA)	330 ±5%	3.2	1.6	1.0	1.5	0.3 min.
GRM31A7U2J471JW31D	DC630	U2J (EIA)	470 ±5%	3.2	1.6	1.0	1.5	0.3 min.
GRM31A7U2J681JW31D	DC630	U2J (EIA)	680 ±5%	3.2	1.6	1.0	1.5	0.3 min.
GRM31A7U2J102JW31D	DC630	U2J (EIA)	1000 ±5%	3.2	1.6	1.0	1.5	0.3 min.
GRM32A7U2J152JW31D	DC630	U2J (EIA)	1500 ±5%	3.2	2.5	1.0	1.5	0.3 min.
GRM32A7U2J222JW31D	DC630	U2J (EIA)	2200 ±5%	3.2	2.5	1.0	1.5	0.3 min.
GRM31A7U3A100JW31D	DC1000	U2J (EIA)	10 ±5%	3.2	1.6	1.0	1.5	0.3 min.
GRM31A7U3A150JW31D	DC1000	U2J (EIA)	15 ±5%	3.2	1.6	1.0	1.5	0.3 min.
GRM31A7U3A220JW31D	DC1000	U2J (EIA)	22 ±5%	3.2	1.6	1.0	1.5	0.3 min.
GRM31A7U3A330JW31D	DC1000	U2J (EIA)	33 ±5%	3.2	1.6	1.0	1.5	0.3 min.

Continued on the following page.

 Continued from the preceding page.

Part Number	Rated Voltage (V)	TC Code (Standard)	Capacitance (pF)	Length L (mm)	Width W (mm)	Thickness T (mm)	Electrode g min. (mm)	Electrode e (mm)
GRM31A7U3A470JW31D	DC1000	U2J (EIA)	47 ±5%	3.2	1.6	1.0	1.5	0.3 min.
GRM31A7U3A680JW31D	DC1000	U2J (EIA)	68 ±5%	3.2	1.6	1.0	1.5	0.3 min.
GRM31A7U3A101JW31D	DC1000	U2J (EIA)	100 ±5%	3.2	1.6	1.0	1.5	0.3 min.
GRM31A7U3A151JW31D	DC1000	U2J (EIA)	150 ±5%	3.2	1.6	1.0	1.5	0.3 min.
GRM31A7U3A221JW31D	DC1000	U2J (EIA)	220 ±5%	3.2	1.6	1.0	1.5	0.3 min.
GRM31A7U3A331JW31D	DC1000	U2J (EIA)	330 ±5%	3.2	1.6	1.0	1.5	0.3 min.
GRM31B7U3A471JW31L	DC1000	U2J (EIA)	470 ±5%	3.2	1.6	1.25	1.5	0.3 min.
GRM31A7U3D100JW31D	DC2000	U2J (EIA)	10 ±5%	3.2	1.6	1.0	1.8	0.3 min.
GRM31A7U3D120JW31D	DC2000	U2J (EIA)	12 ±5%	3.2	1.6	1.0	1.8	0.3 min.
GRM31A7U3D150JW31D	DC2000	U2J (EIA)	15 ±5%	3.2	1.6	1.0	1.8	0.3 min.
GRM31A7U3D180JW31D	DC2000	U2J (EIA)	18 ±5%	3.2	1.6	1.0	1.8	0.3 min.
GRM31A7U3D220JW31D	DC2000	U2J (EIA)	22 ±5%	3.2	1.6	1.0	1.8	0.3 min.
GRM31A7U3D270JW31D	DC2000	U2J (EIA)	27 ±5%	3.2	1.6	1.0	1.8	0.3 min.
GRM31A7U3D330JW31D	DC2000	U2J (EIA)	33 ±5%	3.2	1.6	1.0	1.8	0.3 min.
GRM31A7U3D390JW31D	DC2000	U2J (EIA)	39 ±5%	3.2	1.6	1.0	1.8	0.3 min.
GRM31A7U3D470JW31D	DC2000	U2J (EIA)	47 ±5%	3.2	1.6	1.0	1.8	0.3 min.
GRM31A7U3D560JW31D	DC2000	U2J (EIA)	56 ±5%	3.2	1.6	1.0	1.8	0.3 min.
GRM31A7U3D680JW31D	DC2000	U2J (EIA)	68 ±5%	3.2	1.6	1.0	1.8	0.3 min.
GRM32A7U3D820JW31D	DC2000	U2J (EIA)	82 ±5%	3.2	2.5	1.0	1.8	0.3 min.
GRM32A7U3D101JW31D	DC2000	U2J (EIA)	100 ±5%	3.2	2.5	1.0	1.8	0.3 min.
GRM32A7U3D121JW31D	DC2000	U2J (EIA)	120 ±5%	3.2	2.5	1.0	1.8	0.3 min.
GRM32A7U3D151JW31D	DC2000	U2J (EIA)	150 ±5%	3.2	2.5	1.0	1.8	0.3 min.
GRM32B7U3D181JW31L	DC2000	U2J (EIA)	180 ±5%	3.2	2.5	1.25	1.8	0.3 min.
GRM32B7U3D221JW31L	DC2000	U2J (EIA)	220 ±5%	3.2	2.5	1.25	1.8	0.3 min.
GRM42A7U3F270JW31L	DC3150	U2J (EIA)	27 ±5%	4.5	2.0	1.0	2.9	0.3 min.
GRM42A7U3F330JW31L	DC3150	U2J (EIA)	33 ±5%	4.5	2.0	1.0	2.9	0.3 min.
GRM42A7U3F390JW31L	DC3150	U2J (EIA)	39 ±5%	4.5	2.0	1.0	2.9	0.3 min.
GRM42A7U3F470JW31L	DC3150	U2J (EIA)	47 ±5%	4.5	2.0	1.0	2.9	0.3 min.
GRM42A7U3F560JW31L	DC3150	U2J (EIA)	56 ±5%	4.5	2.0	1.0	2.9	0.3 min.
GRM42A7U3F680JW31L	DC3150	U2J (EIA)	68 ±5%	4.5	2.0	1.0	2.9	0.3 min.
GRM42A7U3F820JW31L	DC3150	U2J (EIA)	82 ±5%	4.5	2.0	1.0	2.9	0.3 min.
GRM42A7U3F101JW31L	DC3150	U2J (EIA)	100 ±5%	4.5	2.0	1.0	2.9	0.3 min.

Specifications and Test Methods

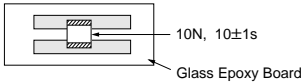
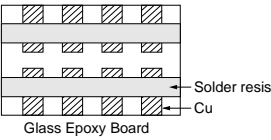
No.	Item	Specifications	Test Method												
1	Operating Temperature Range	-55 to +125°C	—												
2	Appearance	No defects or abnormalities	Visual inspection												
3	Dimensions	Within the specified dimension	Using calipers												
4	Dielectric Strength	No defects or abnormalities	<p>No failure should be observed when voltage in Table is applied between the terminations for 1 to 5 sec., provided the charge/discharge current is less than 50mA.</p> <table border="1" style="width: 100%; border-collapse: collapse;"> <thead> <tr> <th>Rated voltage</th> <th>Test voltage</th> </tr> </thead> <tbody> <tr> <td>DC250V</td> <td>200% of the rated voltage</td> </tr> <tr> <td>DC630V</td> <td>150% of the rated voltage</td> </tr> <tr> <td>DC1kV, DC2kV</td> <td>120% of the rated voltage</td> </tr> <tr> <td>DC3.15kV</td> <td>DC4095V</td> </tr> </tbody> </table>	Rated voltage	Test voltage	DC250V	200% of the rated voltage	DC630V	150% of the rated voltage	DC1kV, DC2kV	120% of the rated voltage	DC3.15kV	DC4095V		
Rated voltage	Test voltage														
DC250V	200% of the rated voltage														
DC630V	150% of the rated voltage														
DC1kV, DC2kV	120% of the rated voltage														
DC3.15kV	DC4095V														
5	Insulation Resistance (I.R.)	More than 10,000MΩ	The insulation resistance should be measured with DC500±50V (DC250±25V in case of rated voltage: DC250V) and within 60±5 sec. of charging.												
6	Capacitance	Within the specified tolerance	<p>The capacitance/Q should be measured at the frequency and voltage shown as follows.</p> <table border="1" style="width: 100%; border-collapse: collapse;"> <thead> <tr> <th>Capacitance</th> <th>Frequency</th> <th>Voltage</th> </tr> </thead> <tbody> <tr> <td>C<1,000pF</td> <td>1±0.2MHz</td> <td>AC0.5 to 5V(r.m.s.)</td> </tr> <tr> <td>C≥1,000pF</td> <td>1±0.2kHz</td> <td>AC1±0.2V(r.m.s.)</td> </tr> </tbody> </table>	Capacitance	Frequency	Voltage	C<1,000pF	1±0.2MHz	AC0.5 to 5V(r.m.s.)	C≥1,000pF	1±0.2kHz	AC1±0.2V(r.m.s.)			
Capacitance	Frequency	Voltage													
C<1,000pF	1±0.2MHz	AC0.5 to 5V(r.m.s.)													
C≥1,000pF	1±0.2kHz	AC1±0.2V(r.m.s.)													
7	Q	1,000 min.													
8	Capacitance Temperature Characteristics	Temp. Coefficient -750±120 ppm/°C (Temp. Range: +25 to +125°C) -750+120, -347 ppm/°C (Temp. Range: -55 to +25°C)	<p>The capacitance measurement should be made at each step specified in Table.</p> <table border="1" style="width: 100%; border-collapse: collapse;"> <thead> <tr> <th>Step</th> <th>Temperature (°C)</th> </tr> </thead> <tbody> <tr> <td>1</td> <td>25±2</td> </tr> <tr> <td>2</td> <td>Min. Operating Temp.±3</td> </tr> <tr> <td>3</td> <td>25±2</td> </tr> <tr> <td>4</td> <td>Max. Operating Temp.±2</td> </tr> <tr> <td>5</td> <td>25±2</td> </tr> </tbody> </table>	Step	Temperature (°C)	1	25±2	2	Min. Operating Temp.±3	3	25±2	4	Max. Operating Temp.±2	5	25±2
Step	Temperature (°C)														
1	25±2														
2	Min. Operating Temp.±3														
3	25±2														
4	Max. Operating Temp.±2														
5	25±2														
9	Adhesive Strength of Termination	No removal of the terminations or other defect should occur.	<p>Solder the capacitor to the testing jig (glass epoxy board) shown in Fig. 1. Then apply 10N force in the direction of the arrow. The soldering should be done using the reflow method and should be conducted with care so that the soldering is uniform and free of defects such as heat shock.</p> <div style="text-align: center;">  <p>10N, 10±1s Glass Epoxy Board</p> </div> <p style="text-align: center;">Fig. 1</p>												
10	Vibration Resistance	Appearance	No defects or abnormalities												
		Capacitance	Within the specified tolerance												
		Q	1,000 min.												
			<p>Solder the capacitor to the test jig (glass epoxy board). The capacitor should be subjected to a simple harmonic motion having a total amplitude of 1.5mm, the frequency being varied uniformly between the approximate limits of 10 and 55Hz. The frequency range, from 10 to 55Hz and return to 10Hz, should be traversed in approximately 1 min. This motion should be applied for a period of 2 hrs. in each of 3 mutually perpendicular directions (total of 6 hrs.).</p> <div style="text-align: center;">  <p>Solder resist Cu Glass Epoxy Board</p> </div>												

Continued on the following page. ↗

Specifications and Test Methods

Continued from the preceding page.

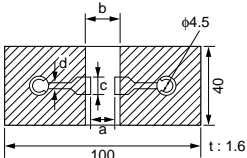
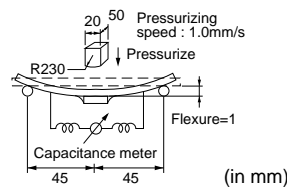
No.	Item	Specifications	Test Method																							
11	Deflection	No cracking or marking defects should occur.	Solder the capacitor to the testing jig (glass epoxy board) shown in Fig. 2. Then apply a force in the direction shown in Fig. 3. The soldering should be done using the reflow method and should be conducted with care so that the soldering is uniform and free of defects such as heat shock.																							
		 <table border="1" data-bbox="367 504 877 649"> <thead> <tr> <th rowspan="2">L×W (mm)</th> <th colspan="4">Dimension (mm)</th> </tr> <tr> <th>a</th> <th>b</th> <th>c</th> <th>d</th> </tr> </thead> <tbody> <tr> <td>2.0×1.25</td> <td>1.2</td> <td>4.0</td> <td>1.65</td> <td rowspan="4">1.0</td> </tr> <tr> <td>3.2×1.6</td> <td>2.2</td> <td>5.0</td> <td>2.0</td> </tr> <tr> <td>3.2×2.5</td> <td>2.2</td> <td>5.0</td> <td>2.9</td> </tr> <tr> <td>4.5×2.0</td> <td>3.5</td> <td>7.0</td> <td>2.4</td> </tr> </tbody> </table> <p style="text-align: center;">Fig. 2</p>		L×W (mm)	Dimension (mm)				a	b	c	d	2.0×1.25	1.2	4.0	1.65	1.0	3.2×1.6	2.2	5.0	2.0	3.2×2.5	2.2	5.0	2.9	4.5×2.0
L×W (mm)	Dimension (mm)																									
	a	b	c	d																						
2.0×1.25	1.2	4.0	1.65	1.0																						
3.2×1.6	2.2	5.0	2.0																							
3.2×2.5	2.2	5.0	2.9																							
4.5×2.0	3.5	7.0	2.4																							
			 <p style="text-align: center;">Fig. 3</p>																							
12	Solderability of Termination	75% of the terminations are to be soldered evenly and continuously.	Immerse the capacitor in a solution of ethanol (JIS-K-8101) and rosin (JIS-K-5902) (25% rosin in weight proportion). Immerse in solder solution for 2±0.5 sec. Immersing speed: 25±2.5mm/s Temp. of solder: 245±5°C Lead Free Solder (Sn-3.0Ag-0.5Cu) 235±5°C H60A or H63A Eutectic Solder																							
13	Resistance to Soldering Heat	Appearance	No marking defects	Preheat the capacitor at 120 to 150°C* for 1 min. Immerse the capacitor in solder solution at 260±5°C for 10±1 sec. Let sit at room condition* for 24±2 hrs., then measure. •Immersing speed: 25±2.5mm/s *Preheating for more than 3.2×2.5mm																						
		Capacitance Change	Within ±2.5%																							
		Q	1,000 min.																							
		I.R.	More than 10,000MΩ																							
		Dielectric Strength	In accordance with item No.4																							
14	Temperature Cycle	Appearance	No marking defects	Fix the capacitor to the supporting jig (glass epoxy board) shown in Fig. 4. Perform the 5 cycles according to the 4 heat treatments listed in the following table. Let sit for 24±2 hrs. at room condition*, then measure.																						
		Capacitance Change	Within ±2.5%																							
		Q	500 min.																							
		I.R.	More than 10,000MΩ																							
		Dielectric Strength	In accordance with item No.4																							
15	Humidity (Steady State)	Appearance	No marking defects	Let the capacitor sit at 40±2°C and relative humidity of 90 to 95% for 500±24 hrs. Remove and let sit for 24±2 hrs. at room condition*, then measure.																						
		Capacitance Change	Within ±5.0%																							
		Q	350 min.																							
		I.R.	More than 1,000MΩ																							
		Dielectric Strength	In accordance with item No.4																							
16	Life	Appearance	No marking defects	Apply 120% of the rated voltage for 1,000±48 hrs. at maximum operating temperature ±3°C. Remove and let sit for 24±2 hrs. at room condition*, then measure. The charge/discharge current is less than 50mA.																						
		Capacitance Change	Within ±3.0%																							
		Q	350 min.																							
		I.R.	More than 1,000MΩ																							
		Dielectric Strength	In accordance with item No.4																							

* "Room condition" Temperature: 15 to 35°C, Relative humidity: 45 to 75%, Atmospheric pressure: 86 to 106kPa

Chip Monolithic Ceramic Capacitors



Medium Voltage High Capacitance for General Use

■ Features

1. A new monolithic structure for small, high capacitance capable of operating at high voltage levels
2. Sn-plated external electrodes realizes good solderability.
3. Use the GRM18/21/31 types with flow or reflow soldering, and other types with reflow soldering only.

■ Applications

1. Ideal for use on diode-snubber circuits for switching power supplies
2. Ideal for use as primary-secondary coupling for DC-DC converter
3. Ideal for use on line filters and ringer detectors for telephones, facsimiles and modems

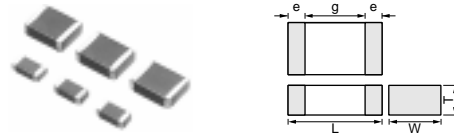

Part Number	Dimensions (mm)					
	L	W	T	e	g min.	
GRM188	1.6 ±0.1	0.8 ±0.1	0.8 ±0.1	0.2 to 0.5	0.4	
GRM21A	2.0 ±0.2	1.25 ±0.2	1.0 +0,-0.3			
GRM21B			1.25 ±0.2	0.3 min.	1.2	
GRM31B	3.2 ±0.2	1.6 ±0.2	1.25 +0,-0.3			
GRM31C			1.6 ±0.2			
GRM32Q	3.2 ±0.3	2.5 ±0.2	1.5 +0,-0.3			
GRM32D			2.0 +0,-0.3			
GRM43Q	4.5 ±0.4	3.2 ±0.3	1.5 +0,-0.3			
GRM43D			2.0 +0,-0.3			
GRM55D	5.7 ±0.4	5.0 ±0.4	2.0 +0,-0.3			3.2

Part Number	Rated Voltage (V)	TC Code (Standard)	Capacitance	Length L (mm)	Width W (mm)	Thickness T (mm)	Electrode g min. (mm)	Electrode e (mm)
GRM188R72E221KW07D	DC250	X7R (EIA)	220pF ±10%	1.6	0.8	0.8	0.4	0.2 to 0.5
GRM188R72E331KW07D	DC250	X7R (EIA)	330pF ±10%	1.6	0.8	0.8	0.4	0.2 to 0.5
GRM188R72E471KW07D	DC250	X7R (EIA)	470pF ±10%	1.6	0.8	0.8	0.4	0.2 to 0.5
GRM188R72E681KW07D	DC250	X7R (EIA)	680pF ±10%	1.6	0.8	0.8	0.4	0.2 to 0.5
GRM188R72E102KW07D	DC250	X7R (EIA)	1000pF ±10%	1.6	0.8	0.8	0.4	0.2 to 0.5
GRM21AR72E102KW01D	DC250	X7R (EIA)	1000pF ±10%	2.0	1.25	1.0	0.7	0.3 min.
GRM188R72E152KW07D	DC250	X7R (EIA)	1500pF ±10%	1.6	0.8	0.8	0.4	0.2 to 0.5
GRM21AR72E152KW01D	DC250	X7R (EIA)	1500pF ±10%	2.0	1.25	1.0	0.7	0.3 min.
GRM188R72E222KW07D	DC250	X7R (EIA)	2200pF ±10%	1.6	0.8	0.8	0.4	0.2 to 0.5
GRM21AR72E222KW01D	DC250	X7R (EIA)	2200pF ±10%	2.0	1.25	1.0	0.7	0.3 min.
GRM21AR72E332KW01D	DC250	X7R (EIA)	3300pF ±10%	2.0	1.25	1.0	0.7	0.3 min.
GRM21AR72E472KW01D	DC250	X7R (EIA)	4700pF ±10%	2.0	1.25	1.0	0.7	0.3 min.
GRM21AR72E682KW01D	DC250	X7R (EIA)	6800pF ±10%	2.0	1.25	1.0	0.7	0.3 min.
GRM21BR72E103KW03L	DC250	X7R (EIA)	10000pF ±10%	2.0	1.25	1.25	0.7	0.3 min.
GRM31BR72E153KW01L	DC250	X7R (EIA)	15000pF ±10%	3.2	1.6	1.25	1.2	0.3 min.
GRM31BR72E223KW01L	DC250	X7R (EIA)	22000pF ±10%	3.2	1.6	1.25	1.2	0.3 min.
GRM31CR72E333KW03L	DC250	X7R (EIA)	33000pF ±10%	3.2	1.6	1.6	1.2	0.3 min.
GRM31CR72E473KW03L	DC250	X7R (EIA)	47000pF ±10%	3.2	1.6	1.6	1.2	0.3 min.
GRM31BR72E683KW01L	DC250	X7R (EIA)	68000pF ±10%	3.2	1.6	1.25	1.2	0.3 min.
GRM32QR72E683KW01L	DC250	X7R (EIA)	68000pF ±10%	3.2	2.5	1.5	1.2	0.3 min.
GRM31CR72E104KW03L	DC250	X7R (EIA)	0.10µF ±10%	3.2	1.6	1.6	1.2	0.3 min.
GRM32DR72E104KW01L	DC250	X7R (EIA)	0.10µF ±10%	3.2	2.5	2.0	1.2	0.3 min.
GRM43QR72E154KW01L	DC250	X7R (EIA)	0.15µF ±10%	4.5	3.2	1.5	2.2	0.3 min.
GRM32DR72E224KW01L	DC250	X7R (EIA)	0.22µF ±10%	3.2	2.5	2.0	1.2	0.3 min.
GRM43DR72E224KW01L	DC250	X7R (EIA)	0.22µF ±10%	4.5	3.2	2.0	2.2	0.3 min.
GRM43DR72E334KW01L	DC250	X7R (EIA)	0.33µF ±10%	4.5	3.2	2.0	2.2	0.3 min.
GRM55DR72E334KW01L	DC250	X7R (EIA)	0.33µF ±10%	5.7	5.0	2.0	3.2	0.3 min.
GRM43DR72E474KW01L	DC250	X7R (EIA)	0.47µF ±10%	4.5	3.2	2.0	2.2	0.3 min.
GRM55DR72E474KW01L	DC250	X7R (EIA)	0.47µF ±10%	5.7	5.0	2.0	3.2	0.3 min.
GRM55DR72E105KW01L	DC250	X7R (EIA)	1.0µF ±10%	5.7	5.0	2.0	3.2	0.3 min.
GRM31BR72J102KW01L	DC630	X7R (EIA)	1000pF ±10%	3.2	1.6	1.25	1.2	0.3 min.
GRM31BR72J152KW01L	DC630	X7R (EIA)	1500pF ±10%	3.2	1.6	1.25	1.2	0.3 min.

Continued on the following page.

 Continued from the preceding page.

Part Number	Rated Voltage (V)	TC Code (Standard)	Capacitance	Length L (mm)	Width W (mm)	Thickness T (mm)	Electrode g min. (mm)	Electrode e (mm)
GRM31BR72J222KW01L	DC630	X7R (EIA)	2200pF ±10%	3.2	1.6	1.25	1.2	0.3 min.
GRM31BR72J332KW01L	DC630	X7R (EIA)	3300pF ±10%	3.2	1.6	1.25	1.2	0.3 min.
GRM31BR72J472KW01L	DC630	X7R (EIA)	4700pF ±10%	3.2	1.6	1.25	1.2	0.3 min.
GRM31BR72J682KW01L	DC630	X7R (EIA)	6800pF ±10%	3.2	1.6	1.25	1.2	0.3 min.
GRM31BR72J103KW01L	DC630	X7R (EIA)	10000pF ±10%	3.2	1.6	1.25	1.2	0.3 min.
GRM31CR72J153KW03L	DC630	X7R (EIA)	15000pF ±10%	3.2	1.6	1.6	1.2	0.3 min.
GRM32QR72J223KW01L	DC630	X7R (EIA)	22000pF ±10%	3.2	2.5	1.5	1.2	0.3 min.
GRM32DR72J333KW01L	DC630	X7R (EIA)	33000pF ±10%	3.2	2.5	2.0	1.2	0.3 min.
GRM32DR72J473KW01L	DC630	X7R (EIA)	47000pF ±10%	3.2	2.5	2.0	1.2	0.3 min.
GRM43QR72J683KW01L	DC630	X7R (EIA)	68000pF ±10%	4.5	3.2	1.5	2.2	0.3 min.
GRM43DR72J104KW01L	DC630	X7R (EIA)	0.10μF ±10%	4.5	3.2	2.0	2.2	0.3 min.
GRM55DR72J154KW01L	DC630	X7R (EIA)	0.15μF ±10%	5.7	5.0	2.0	3.2	0.3 min.
GRM55DR72J224KW01L	DC630	X7R (EIA)	0.22μF ±10%	5.7	5.0	2.0	3.2	0.3 min.
GRM31BR73A471KW01L	DC1000	X7R (EIA)	470pF ±10%	3.2	1.6	1.25	1.2	0.3 min.
GRM31BR73A102KW01L	DC1000	X7R (EIA)	1000pF ±10%	3.2	1.6	1.25	1.2	0.3 min.
GRM31BR73A152KW01L	DC1000	X7R (EIA)	1500pF ±10%	3.2	1.6	1.25	1.2	0.3 min.
GRM31BR73A222KW01L	DC1000	X7R (EIA)	2200pF ±10%	3.2	1.6	1.25	1.2	0.3 min.
GRM31BR73A332KW01L	DC1000	X7R (EIA)	3300pF ±10%	3.2	1.6	1.25	1.2	0.3 min.
GRM31BR73A472KW01L	DC1000	X7R (EIA)	4700pF ±10%	3.2	1.6	1.25	1.2	0.3 min.
GRM32QR73A682KW01L	DC1000	X7R (EIA)	6800pF ±10%	3.2	2.5	1.5	1.2	0.3 min.
GRM32QR73A103KW01L	DC1000	X7R (EIA)	10000pF ±10%	3.2	2.5	1.5	1.2	0.3 min.
GRM32DR73A153KW01L	DC1000	X7R (EIA)	15000pF ±10%	3.2	2.5	2.0	1.2	0.3 min.
GRM32DR73A223KW01L	DC1000	X7R (EIA)	22000pF ±10%	3.2	2.5	2.0	1.2	0.3 min.
GRM43DR73A333KW01L	DC1000	X7R (EIA)	33000pF ±10%	4.5	3.2	2.0	2.2	0.3 min.
GRM43DR73A473KW01L	DC1000	X7R (EIA)	47000pF ±10%	4.5	3.2	2.0	2.2	0.3 min.
GRM55DR73A104KW01L	DC1000	X7R (EIA)	0.10μF ±10%	5.7	5.0	2.0	3.2	0.3 min.

Specifications and Test Methods

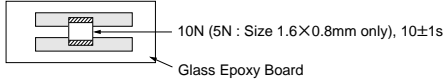
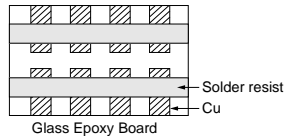
No.	Item	Specifications	Test Method									
1	Operating Temperature Range	-55 to +125°C	—									
2	Appearance	No defects or abnormalities	Visual inspection									
3	Dimensions	Within the specified dimensions	Using calipers									
4	Dielectric Strength	No defects or abnormalities	No failure should be observed when 150% of the rated voltage (200% of the rated voltage in case of rated voltage: DC250V, 120% of the rated voltage in case of rated voltage: DC1kV) is applied between the terminations for 1 to 5 sec., provided the charge/discharge current is less than 50mA.									
5	Insulation Resistance (I.R.)	C≥0.01μF: More than 100MΩ • μF C<0.01μF: More than 10,000MΩ	The insulation resistance should be measured with DC500±50V (DC250±25V in case of rated voltage: DC250V) and within 60±5 sec. of charging.									
6	Capacitance	Within the specified tolerance	The capacitance/D.F. should be measured at a frequency of 1±0.2kHz and a voltage of AC1±0.2V(r.m.s.)									
7	Dissipation Factor (D.F.)	0.025 max.										
8	Capacitance Temperature Characteristics	Cap. Change Within ±15% (Temp. Range: -55 to +125°C)	The capacitance measurement should be made at each step specified in Table.									
			<table border="1" style="width: 100%; border-collapse: collapse; margin-left: 20px;"> <thead> <tr> <th style="width: 15%;">Step</th> <th style="width: 85%;">Temperature (°C)</th> </tr> </thead> <tbody> <tr> <td style="text-align: center;">1</td> <td style="text-align: center;">25±2</td> </tr> <tr> <td style="text-align: center;">2</td> <td style="text-align: center;">Min. Operating Temp.±3</td> </tr> <tr> <td style="text-align: center;">3</td> <td style="text-align: center;">25±2</td> </tr> <tr> <td style="text-align: center;">4</td> <td style="text-align: center;">Max. Operating Temp.±2</td> </tr> <tr> <td style="text-align: center;">5</td> <td style="text-align: center;">25±2</td> </tr> </tbody> </table> <p>•Pretreatment Perform a heat treatment at 150±5°C for 60±5 min. and then let sit for 24±2 hrs. at room condition*.</p>	Step	Temperature (°C)	1	25±2	2	Min. Operating Temp.±3	3	25±2	4
Step	Temperature (°C)											
1	25±2											
2	Min. Operating Temp.±3											
3	25±2											
4	Max. Operating Temp.±2											
5	25±2											
9	Adhesive Strength of Termination	No removal of the terminations or other defect should occur.	<p>Solder the capacitor to the testing jig (glass epoxy board) shown in Fig. 1. Then apply 10N force in the direction of the arrow. The soldering should be done using the reflow method and should be conducted with care so that the soldering is uniform and free of defects such as heat shock.</p> <div style="text-align: center;">  <p>Fig. 1</p> </div>									
10	Vibration Resistance	Appearance	No defects or abnormalities									
		Capacitance	Within the specified tolerance									
		D.F.	0.025 max.									
			<p>Solder the capacitor to the test jig (glass epoxy board). The capacitor should be subjected to a simple harmonic motion having a total amplitude of 1.5mm, the frequency being varied uniformly between the approximate limits of 10 and 55Hz. The frequency range, from 10 to 55Hz and return to 10Hz, should be traversed in approximately 1 min. This motion should be applied for a period of 2 hrs. in each of 3 mutually perpendicular directions (total of 6 hrs.).</p> <div style="text-align: center;">  </div>									

* "Room condition" Temperature: 15 to 35°C, Relative humidity: 45 to 75%, Atmospheric pressure: 86 to 106kPa

Continued on the following page.

Specifications and Test Methods

Continued from the preceding page.

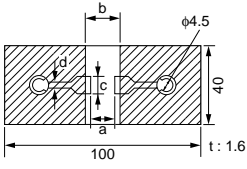
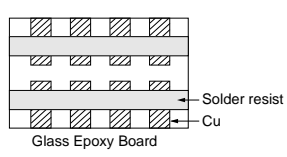
No.	Item	Specifications	Test Method																																
11	Deflection	No cracking or marking defects should occur.	Solder the capacitor to the testing jig (glass epoxy board) shown in Fig. 2. Then apply a force in the direction shown in Fig. 3. The soldering should be done using the reflow method and should be conducted with care so that the soldering is uniform and free of defects such as heat shock.																																
		 <table border="1" data-bbox="367 504 877 705"> <thead> <tr> <th>LxW (mm)</th> <th colspan="4">Dimension (mm)</th> </tr> <tr> <th></th> <th>a</th> <th>b</th> <th>c</th> <th>d</th> </tr> </thead> <tbody> <tr> <td>1.6x0.8</td> <td>1.0</td> <td>3.0</td> <td>1.2</td> <td rowspan="6">1.0</td> </tr> <tr> <td>2.0x1.25</td> <td>1.2</td> <td>4.0</td> <td>1.65</td> </tr> <tr> <td>3.2x1.6</td> <td>2.2</td> <td>5.0</td> <td>2.0</td> </tr> <tr> <td>3.2x2.5</td> <td>2.2</td> <td>5.0</td> <td>2.9</td> </tr> <tr> <td>4.5x3.2</td> <td>3.5</td> <td>7.0</td> <td>3.7</td> </tr> <tr> <td>5.7x5.0</td> <td>4.5</td> <td>8.0</td> <td>5.6</td> </tr> </tbody> </table> <p>Fig. 2</p>		LxW (mm)	Dimension (mm)					a	b	c	d	1.6x0.8	1.0	3.0	1.2	1.0	2.0x1.25	1.2	4.0	1.65	3.2x1.6	2.2	5.0	2.0	3.2x2.5	2.2	5.0	2.9	4.5x3.2	3.5	7.0	3.7	5.7x5.0
LxW (mm)	Dimension (mm)																																		
	a	b	c	d																															
1.6x0.8	1.0	3.0	1.2	1.0																															
2.0x1.25	1.2	4.0	1.65																																
3.2x1.6	2.2	5.0	2.0																																
3.2x2.5	2.2	5.0	2.9																																
4.5x3.2	3.5	7.0	3.7																																
5.7x5.0	4.5	8.0	5.6																																
12	Solderability of Termination	75% of the terminations are to be soldered evenly and continuously.	Immerse the capacitor in a solution of ethanol (JIS-K-8101) and rosin (JIS-K-5902) (25% rosin in weight proportion). Immerse in solder solution for 2±0.5 sec. Immersing speed: 25±2.5mm/s Temp. of solder: 245±5°C Lead Free Solder (Sn-3.0Ag-0.5Cu) 235±5°C H60A or H63A Eutectic Solder																																
13	Resistance to Soldering Heat	Appearance	No marking defects	Preheat the capacitor at 120 to 150°C* for 1 min. Immerse the capacitor in solder solution at 260±5°C for 10±1 sec. Let sit at room condition* for 24±2 hrs., then measure. •Immersing speed: 25±2.5mm/s •Pretreatment Perform a heat treatment at 150±18°C for 60±5 min. and then let sit for 24±2 hrs. at room condition*.																															
		Capacitance Change	Within ±10%																																
		D.F.	0.025 max.																																
		I.R.	C≥0.01μF: More than 100MΩ • μF C<0.01μF: More than 10,000MΩ																																
		Dielectric Strength	In accordance with item No.4																																
			*Preheating for more than 3.2x2.5mm <table border="1" data-bbox="925 1120 1452 1209"> <thead> <tr> <th>Step</th> <th>Temperature</th> <th>Time</th> </tr> </thead> <tbody> <tr> <td>1</td> <td>100 to 120°C</td> <td>1 min.</td> </tr> <tr> <td>2</td> <td>170 to 200°C</td> <td>1 min.</td> </tr> </tbody> </table>	Step	Temperature	Time	1	100 to 120°C	1 min.	2	170 to 200°C	1 min.																							
Step	Temperature	Time																																	
1	100 to 120°C	1 min.																																	
2	170 to 200°C	1 min.																																	
14	Temperature Cycle	Appearance	No marking defects	Fix the capacitor to the supporting jig (glass epoxy board) shown in Fig. 4. Perform the 5 cycles according to the 4 heat treatments listed in the following table. Let sit for 24±2 hrs. at room condition*, then measure.																															
		Capacitance Change	Within ±7.5%																																
		D.F.	0.025 max.																																
		I.R.	C≥0.01μF: More than 100MΩ • μF C<0.01μF: More than 10,000MΩ																																
		Dielectric Strength	In accordance with item No.4																																
			<table border="1" data-bbox="925 1344 1452 1478"> <thead> <tr> <th>Step</th> <th>Temperature (°C)</th> <th>Time (min.)</th> </tr> </thead> <tbody> <tr> <td>1</td> <td>Min. Operating Temp.±3</td> <td>30±3</td> </tr> <tr> <td>2</td> <td>Room Temp.</td> <td>2 to 3</td> </tr> <tr> <td>3</td> <td>Max. Operating Temp.±2</td> <td>30±3</td> </tr> <tr> <td>4</td> <td>Room Temp.</td> <td>2 to 3</td> </tr> </tbody> </table> •Pretreatment Perform a heat treatment at 150±18°C for 60±5 min. and then let sit for 24±2 hrs. at room condition*.	Step	Temperature (°C)	Time (min.)	1	Min. Operating Temp.±3	30±3	2	Room Temp.	2 to 3	3	Max. Operating Temp.±2	30±3	4	Room Temp.	2 to 3																	
Step	Temperature (°C)	Time (min.)																																	
1	Min. Operating Temp.±3	30±3																																	
2	Room Temp.	2 to 3																																	
3	Max. Operating Temp.±2	30±3																																	
4	Room Temp.	2 to 3																																	
			 <p>Fig. 4</p>																																
15	Humidity (Steady State)	Appearance	No marking defects	Let the capacitor sit at 40±2°C and relative humidity of 90 to 95% for 500±24 hrs. Remove and let sit for 24±2 hrs. at room condition*, then measure. •Pretreatment Perform a heat treatment at 150±18°C for 60±5 min. and then let sit for 24±2 hrs. at room condition*.																															
		Capacitance Change	Within ±15%																																
		D.F.	0.05 max.																																
		I.R.	C≥0.01μF: More than 10MΩ • μF C<0.01μF: More than 1,000MΩ																																
		Dielectric Strength	In accordance with item No.4																																

* "Room condition" Temperature: 15 to 35°C, Relative humidity: 45 to 75%, Atmospheric pressure: 86 to 106kPa

Continued on the following page. 

Specifications and Test Methods

Continued from the preceding page.

No.	Item	Specifications	Test Method
16	Life	Appearance	Apply 120% of the rated voltage (150% of the rated voltage in case of rated voltage: DC250V, 110% of the rated voltage in case of rated voltage: DC1kV) for 1,000 ^{±4} hrs. at maximum operating temperature ±3°C. Remove and let sit for 24 ±2 hrs. at room condition*, then measure. The charge/discharge current is less than 50mA. •Pretreatment Apply test voltage for 60±5 min. at test temperature. Remove and let sit for 24±2 hrs. at room condition*.
	Capacitance Change	Within ±15% (rated voltage: DC250V, DC630V) Within ±20% (rated voltage: DC1kV)	
	D.F.	0.05 max.	
	I.R.	C≥0.01μF: More than 10MΩ • μF C<0.01μF: More than 1,000MΩ	
	Dielectric Strength	In accordance with item No.4	
17	Humidity Loading (Application: DC250V, DC630V item)	Appearance	Apply the rated voltage at 40±2°C and relative humidity of 90 to 95% for 500 ^{±2} hrs. Remove and let sit for 24±2 hrs. at room condition*, then measure. •Pretreatment Apply test voltage for 60±5 min. at test temperature. Remove and let sit for 24±2 hrs. at room condition*.
	Capacitance Change	Within ±15%	
	D.F.	0.05 max.	
	I.R.	C≥0.01μF: More than 10MΩ • μF C<0.01μF: More than 1,000MΩ	
	Dielectric Strength	In accordance with item No.4	

* "Room condition" Temperature: 15 to 35°C, Relative humidity: 45 to 75%, Atmospheric pressure: 86 to 106kPa

Chip Monolithic Ceramic Capacitors



Only for LCD Backlight Inverter Circuit

■ Features

1. Low-loss and suitable for high frequency circuits
2. Murata's original internal electrode structure realizes high flash-over voltage.
3. A new monolithic structure for small, surface-mountable devices capable of operating at high voltage levels.
4. Sn-plated external electrodes realize good solderability.
5. Only for reflow soldering
6. The capacitors less than 22pF can be applied maximum 4.0kV peak to peak at 100kHz or less only for the ballast or the resonance usage in the LCD backlight inverter circuit.

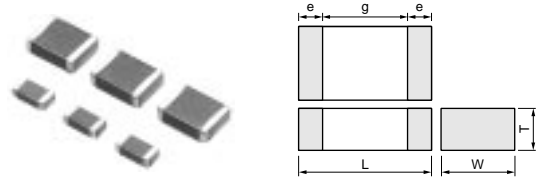

Part Number	Dimensions (mm)				
	L	W	T	e min.	g min.
GRM42A	4.5 ±0.3	2.0 ±0.2	1.0 +0, -0.3	0.3	2.9

■ Applications

Ideal for use as the ballast in LCD backlight inverter.

Part Number	Rated Voltage (V)	TC Code (Standard)	Capacitance (pF)	Length L (mm)	Width W (mm)	Thickness T (mm)	Electrode g min. (mm)	Electrode e (mm)
GRM42A5C3F050DW01L	DC3150	COG (EIA)	5.0 ±0.5pF	4.5	2.0	1.0	2.9	0.3 min.
GRM42A5C3F100JW01L	DC3150	COG (EIA)	10 ±5%	4.5	2.0	1.0	2.9	0.3 min.
GRM42A5C3F120JW01L	DC3150	COG (EIA)	12 ±5%	4.5	2.0	1.0	2.9	0.3 min.
GRM42A5C3F150JW01L	DC3150	COG (EIA)	15 ±5%	4.5	2.0	1.0	2.9	0.3 min.
GRM42A5C3F180JW01L	DC3150	COG (EIA)	18 ±5%	4.5	2.0	1.0	2.9	0.3 min.
GRM42A5C3F220JW01L	DC3150	COG (EIA)	22 ±5%	4.5	2.0	1.0	2.9	0.3 min.
GRM42A5C3F270JW01L	DC3150	COG (EIA)	27 ±5%	4.5	2.0	1.0	2.9	0.3 min.
GRM42A5C3F330JW01L	DC3150	COG (EIA)	33 ±5%	4.5	2.0	1.0	2.9	0.3 min.
GRM42A5C3F390JW01L	DC3150	COG (EIA)	39 ±5%	4.5	2.0	1.0	2.9	0.3 min.
GRM42A5C3F470JW01L	DC3150	COG (EIA)	47 ±5%	4.5	2.0	1.0	2.9	0.3 min.

Specifications and Test Methods

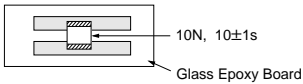
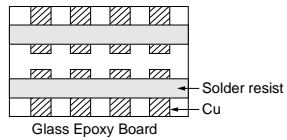
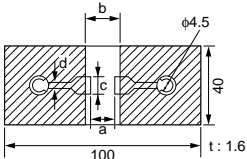
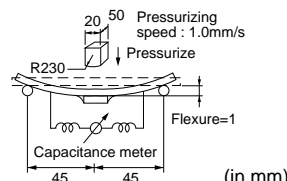
No.	Item	Specifications	Test Method														
1	Operating Temperature Range	-55 to +125°C	—														
2	Appearance	No defects or abnormalities	Visual inspection														
3	Dimensions	Within the specified dimension	Using calipers														
4	Dielectric Strength	No defects or abnormalities	No failure should be observed when DC4095V is applied between the terminations for 1 to 5 sec., provided the charge/discharge current is less than 50mA.														
5	Insulation Resistance (I.R.)	More than 10,000MΩ	The insulation resistance should be measured with DC500±50V and within 60±5 sec. of charging.														
6	Capacitance	Within the specified tolerance	The capacitance/Q should be measured at a frequency of 1±0.2MHz and a voltage of AC0.5 to 5V(r.m.s.)														
7	Q	1,000 min.															
8	Capacitance Temperature Characteristics	Temp. Coefficient 0±30 ppm/°C (Temp. Range: +25 to +125°C) 0+30, -72 ppm/°C (Temp. Range: -55 to +25°C)	The capacitance measurement should be made at each step specified in Table.														
			<table border="1" style="margin: auto; border-collapse: collapse;"> <thead> <tr style="background-color: #e0e0e0;"> <th style="width: 10%;">Step</th> <th style="width: 90%;">Temperature (°C)</th> </tr> </thead> <tbody> <tr> <td style="text-align: center;">1</td> <td style="text-align: center;">25±2</td> </tr> <tr> <td style="text-align: center;">2</td> <td style="text-align: center;">Min. Operating Temp.±3</td> </tr> <tr> <td style="text-align: center;">3</td> <td style="text-align: center;">25±2</td> </tr> <tr> <td style="text-align: center;">4</td> <td style="text-align: center;">Max. Operating Temp.±2</td> </tr> <tr> <td style="text-align: center;">5</td> <td style="text-align: center;">25±2</td> </tr> </tbody> </table>	Step	Temperature (°C)	1	25±2	2	Min. Operating Temp.±3	3	25±2	4	Max. Operating Temp.±2	5	25±2		
Step	Temperature (°C)																
1	25±2																
2	Min. Operating Temp.±3																
3	25±2																
4	Max. Operating Temp.±2																
5	25±2																
9	Adhesive Strength of Termination	No removal of the terminations or other defect should occur.	<p>Solder the capacitor to the testing jig (glass epoxy board) shown in Fig. 1. Then apply 10N force in the direction of the arrow. The soldering should be done using the reflow method and should be conducted with care so that the soldering is uniform and free of defects such as heat shock.</p> <div style="text-align: center;">  <p>10N, 10±1s Glass Epoxy Board</p> </div> <p style="text-align: center;">Fig. 1</p>														
10	Vibration Resistance	Appearance	No defects or abnormalities														
		Capacitance	Within the specified tolerance														
		Q	1,000 min.														
			<p>Solder the capacitor to the test jig (glass epoxy board). The capacitor should be subjected to a simple harmonic motion having a total amplitude of 1.5mm, the frequency being varied uniformly between the approximate limits of 10 and 55Hz. The frequency range, from 10 to 55Hz and return to 10Hz, should be traversed in approximately 1 min. This motion should be applied for a period of 2 hrs. in each of 3 mutually perpendicular directions (total of 6 hrs.).</p> <div style="text-align: center;">  <p>Solder resist Cu Glass Epoxy Board</p> </div>														
11	Deflection	No cracking or marking defects should occur.	<p>Solder the capacitor to the testing jig (glass epoxy board) shown in Fig. 2. Then apply a force in the direction shown in Fig. 3. The soldering should be done using the reflow method and should be conducted with care so that the soldering is uniform and free of defects such as heat shock.</p> <div style="text-align: center;">  <p style="text-align: center;">t: 1.6</p> <table border="1" style="margin: auto; border-collapse: collapse;"> <thead> <tr style="background-color: #e0e0e0;"> <th rowspan="2">L×W (mm)</th> <th colspan="4">Dimension (mm)</th> </tr> <tr style="background-color: #e0e0e0;"> <th>a</th> <th>b</th> <th>c</th> <th>d</th> </tr> </thead> <tbody> <tr> <td style="text-align: center;">4.5×2.0</td> <td style="text-align: center;">3.5</td> <td style="text-align: center;">7.0</td> <td style="text-align: center;">2.4</td> <td style="text-align: center;">1.0</td> </tr> </tbody> </table> <p style="text-align: center;">Fig. 2</p> </div>	L×W (mm)	Dimension (mm)				a	b	c	d	4.5×2.0	3.5	7.0	2.4	1.0
		L×W (mm)			Dimension (mm)												
a	b		c	d													
4.5×2.0	3.5	7.0	2.4	1.0													
			<div style="text-align: center;">  <p style="text-align: center;">20 50 Pressurizing speed: 1.0mm/s Pressurize R230 Flexure=1 Capacitance meter 45 45 (in mm)</p> </div> <p style="text-align: center;">Fig. 3</p>														

Continued on the following page.

Specifications and Test Methods

Continued from the preceding page.

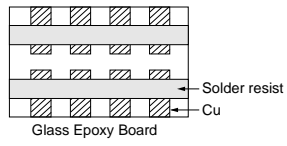
No.	Item	Specifications	Test Method															
12	Solderability of Termination	75% of the terminations are to be soldered evenly and continuously.	Immerse the capacitor in a solution of ethanol (JIS-K-8101) and rosin (JIS-K-5902) (25% rosin in weight proportion). Immerse in solder solution for 2±0.5 sec. Immersing speed: 25±2.5mm/s Temp. of solder: 245±5°C Lead Free Solder (Sn-3.0Ag-0.5Cu) 235±5°C H60A or H63A Eutectic Solder															
13	Resistance to Soldering Heat	Appearance	No marking defects															
		Capacitance Change	Within ±2.5%															
		Q	1,000 min.															
		I.R.	More than 10,000MΩ															
		Dielectric Strength	In accordance with item No.4															
			Preheat the capacitor as table. Immerse the capacitor in solder solution at 260±5°C for 10±1 sec. Let sit at room condition* for 24±2 hrs., then measure. •Immersing speed: 25±2.5mm/s															
			*Preheating															
			<table border="1"> <thead> <tr> <th>Step</th> <th>Temperature</th> <th>Time</th> </tr> </thead> <tbody> <tr> <td>1</td> <td>100 to 120°C</td> <td>1 min.</td> </tr> <tr> <td>2</td> <td>170 to 200°C</td> <td>1 min.</td> </tr> </tbody> </table>	Step	Temperature	Time	1	100 to 120°C	1 min.	2	170 to 200°C	1 min.						
Step	Temperature	Time																
1	100 to 120°C	1 min.																
2	170 to 200°C	1 min.																
14	Temperature Cycle	Appearance	No marking defects															
		Capacitance Change	Within ±2.5%															
		Q	1,000 min.															
		I.R.	More than 10,000MΩ															
		Dielectric Strength	In accordance with item No.4															
			Fix the capacitor to the supporting jig (glass epoxy board) shown in Fig. 4. Perform the 5 cycles according to the 4 heat treatments listed in the following table. Let sit for 24±2 hrs. at room condition*, then measure.															
			<table border="1"> <thead> <tr> <th>Step</th> <th>Temperature (°C)</th> <th>Time (min.)</th> </tr> </thead> <tbody> <tr> <td>1</td> <td>Min. Operating Temp.±3</td> <td>30±3</td> </tr> <tr> <td>2</td> <td>Room Temp.</td> <td>2 to 3</td> </tr> <tr> <td>3</td> <td>Max. Operating Temp.±2</td> <td>30±3</td> </tr> <tr> <td>4</td> <td>Room Temp.</td> <td>2 to 3</td> </tr> </tbody> </table>	Step	Temperature (°C)	Time (min.)	1	Min. Operating Temp.±3	30±3	2	Room Temp.	2 to 3	3	Max. Operating Temp.±2	30±3	4	Room Temp.	2 to 3
Step	Temperature (°C)	Time (min.)																
1	Min. Operating Temp.±3	30±3																
2	Room Temp.	2 to 3																
3	Max. Operating Temp.±2	30±3																
4	Room Temp.	2 to 3																
			 <p style="text-align: center;">Fig. 4</p>															
15	Humidity (Steady State)	Appearance	No marking defects															
		Capacitance Change	Within ±5.0%															
		Q	350 min.															
		I.R.	More than 1,000MΩ															
		Dielectric Strength	In accordance with item No.4															
			Let the capacitor sit at 40±2°C and relative humidity of 90 to 95% for 500 ^{±24} hrs. Remove and let sit for 24±2 hrs. at room condition*, then measure.															
16	Life	Appearance	No marking defects															
		Capacitance Change	Within ±3.0%															
		Q	350 min.															
		I.R.	More than 1,000MΩ															
		Dielectric Strength	In accordance with item No.4															
			Apply 120% of the rated voltage for 1,000 ^{±48} hrs. at maximum operating temperature ±3°C. Remove and let sit for 24±2 hrs. at room condition*, then measure. The charge/discharge current is less than 50mA.															

* "Room condition" Temperature: 15 to 35°C, Relative humidity: 45 to 75%, Atmospheric pressure: 86 to 106kPa

Chip Monolithic Ceramic Capacitors



Only for Information Devices/Tip & Ring

■ Features

1. These items are designed specifically for telecommunications devices (IEEE802.3) in Ethernet LAN and primary-secondary coupling for DC-DC converter.
2. A new monolithic structure for small, high capacitance capable of operating at high voltage levels
3. Sn-plated external electrodes realizes good solderability.
4. Only for reflow soldering
5. The low-profile type (thickness: 1.5mm max.) is available. Fit for use on thinner type equipment.

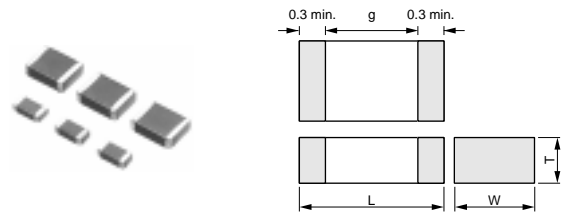

Part Number	Dimensions (mm)			
	L	W	T	g min.
GR442Q	4.5 ±0.3	2.0 ±0.2	1.5 +0, -0.3	2.5
GR443D	4.5 ±0.4	3.2 ±0.3	2.0 +0, -0.3	
GR443Q			1.5 +0, -0.3	
GR455D	5.7 ±0.4	5.0 ±0.4	2.0 +0, -0.3	3.2

■ Applications

1. Ideal for use on telecommunications devices in Ethernet LAN
2. Ideal for use as primary-secondary coupling for DC-DC converter

Part Number	Rated Voltage (V)	TC Code (Standard)	Capacitance (pF)	Length L (mm)	Width W (mm)	Thickness T (mm)	Electrode g min. (mm)	Electrode e (mm)
GR442QR73D101KW01L	DC2000	X7R (EIA)	100 ±10%	4.5	2.0	1.5	2.5	0.3 min.
GR442QR73D121KW01L	DC2000	X7R (EIA)	120 ±10%	4.5	2.0	1.5	2.5	0.3 min.
GR442QR73D151KW01L	DC2000	X7R (EIA)	150 ±10%	4.5	2.0	1.5	2.5	0.3 min.
GR442QR73D181KW01L	DC2000	X7R (EIA)	180 ±10%	4.5	2.0	1.5	2.5	0.3 min.
GR442QR73D221KW01L	DC2000	X7R (EIA)	220 ±10%	4.5	2.0	1.5	2.5	0.3 min.
GR442QR73D271KW01L	DC2000	X7R (EIA)	270 ±10%	4.5	2.0	1.5	2.5	0.3 min.
GR442QR73D331KW01L	DC2000	X7R (EIA)	330 ±10%	4.5	2.0	1.5	2.5	0.3 min.
GR442QR73D391KW01L	DC2000	X7R (EIA)	390 ±10%	4.5	2.0	1.5	2.5	0.3 min.
GR442QR73D471KW01L	DC2000	X7R (EIA)	470 ±10%	4.5	2.0	1.5	2.5	0.3 min.
GR442QR73D561KW01L	DC2000	X7R (EIA)	560 ±10%	4.5	2.0	1.5	2.5	0.3 min.
GR442QR73D681KW01L	DC2000	X7R (EIA)	680 ±10%	4.5	2.0	1.5	2.5	0.3 min.
GR442QR73D821KW01L	DC2000	X7R (EIA)	820 ±10%	4.5	2.0	1.5	2.5	0.3 min.
GR442QR73D102KW01L	DC2000	X7R (EIA)	1000 ±10%	4.5	2.0	1.5	2.5	0.3 min.
GR442QR73D122KW01L	DC2000	X7R (EIA)	1200 ±10%	4.5	2.0	1.5	2.5	0.3 min.
GR442QR73D152KW01L	DC2000	X7R (EIA)	1500 ±10%	4.5	2.0	1.5	2.5	0.3 min.
GR443QR73D182KW01L	DC2000	X7R (EIA)	1800 ±10%	4.5	3.2	1.5	2.5	0.3 min.
GR443QR73D222KW01L	DC2000	X7R (EIA)	2200 ±10%	4.5	3.2	1.5	2.5	0.3 min.
GR443QR73D272KW01L	DC2000	X7R (EIA)	2700 ±10%	4.5	3.2	1.5	2.5	0.3 min.
GR443QR73D332KW01L	DC2000	X7R (EIA)	3300 ±10%	4.5	3.2	1.5	2.5	0.3 min.
GR443QR73D392KW01L	DC2000	X7R (EIA)	3900 ±10%	4.5	3.2	1.5	2.5	0.3 min.
GR443DR73D472KW01L	DC2000	X7R (EIA)	4700 ±10%	4.5	3.2	2.0	2.5	0.3 min.
GR455DR73D103KW01L	DC2000	X7R (EIA)	10000 ±10%	5.7	5.0	2.0	3.2	0.3 min.

Specifications and Test Methods

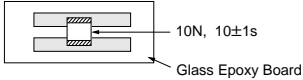
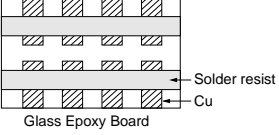
No.	Item	Specifications	Test Method												
1	Operating Temperature Range	-55 to +125°C	-												
2	Appearance	No defects or abnormalities	Visual inspection												
3	Dimensions	Within the specified dimensions	Using calipers												
4	Dielectric Strength	No defects or abnormalities	No failure should be observed when voltage in table is applied between the terminations, provided the charge/discharge current is less than 50mA. <table border="1"> <thead> <tr> <th>Rated voltage</th> <th>Test Voltage</th> <th>Time</th> </tr> </thead> <tbody> <tr> <td rowspan="2">DC2kV</td> <td>120% of the rated voltage</td> <td>60±1 sec.</td> </tr> <tr> <td>AC1500V(r.m.s.)</td> <td>60±1 sec.</td> </tr> </tbody> </table>	Rated voltage	Test Voltage	Time	DC2kV	120% of the rated voltage	60±1 sec.	AC1500V(r.m.s.)	60±1 sec.				
Rated voltage	Test Voltage	Time													
DC2kV	120% of the rated voltage	60±1 sec.													
	AC1500V(r.m.s.)	60±1 sec.													
5	Pulse Voltage	No self healing breakdowns or flash-overs have taken place in the capacitor.	10 impulse of alternating polarity is subjected. (5 impulse for each polarity) The interval between impulse is 60 sec. Applied Voltage: 2.5kV zero to peak												
6	Insulation Resistance (I.R.)	More than 6,000MΩ	The insulation resistance should be measured with DC500±50V and within 60±5 sec. of charging.												
7	Capacitance	Within the specified tolerance	The capacitance/D.F. should be measured at a frequency of 1±0.2kHz and a voltage of AC1±0.2V(r.m.s.)												
8	Dissipation Factor (D.F.)	0.025 max.													
9	Capacitance Temperature Characteristics	Cap. Change within ±15% (Temp. Range: -55 to +125°C)	The capacitance measurement should be made at each step specified in Table. <table border="1"> <thead> <tr> <th>Step</th> <th>Temperature (°C)</th> </tr> </thead> <tbody> <tr> <td>1</td> <td>25±2</td> </tr> <tr> <td>2</td> <td>Min. Operating Temp.±3</td> </tr> <tr> <td>3</td> <td>25±2</td> </tr> <tr> <td>4</td> <td>Max. Operating Temp.±2</td> </tr> <tr> <td>5</td> <td>25±2</td> </tr> </tbody> </table> <p>•Pretreatment Perform a heat treatment at 150±9°C for 60±5 min. and then let sit for 24±2 hrs. at room condition*.</p>	Step	Temperature (°C)	1	25±2	2	Min. Operating Temp.±3	3	25±2	4	Max. Operating Temp.±2	5	25±2
Step	Temperature (°C)														
1	25±2														
2	Min. Operating Temp.±3														
3	25±2														
4	Max. Operating Temp.±2														
5	25±2														
10	Adhesive Strength of Termination	No removal of the terminations or other defect should occur.	Solder the capacitor to the testing jig (glass epoxy board) shown in Fig. 1. Then apply 10N force in the direction of the arrow. The soldering should be done using the reflow method and should be conducted with care so that the soldering is uniform and free of defects such as heat shock.  <p>Fig. 1</p>												
11	Vibration Resistance	Appearance	No defects or abnormalities												
		Capacitance	Within the specified tolerance												
	D.F.	0.025 max.	Solder the capacitor to the test jig (glass epoxy board). The capacitor should be subjected to a simple harmonic motion having a total amplitude of 1.5mm, the frequency being varied uniformly between the approximate limits of 10 and 55Hz. The frequency range, from 10 to 55Hz and return to 10Hz, should be traversed in approximately 1 min. This motion should be applied for a period of 2 hrs. in each of 3 mutually perpendicular directions (total of 6 hrs.). 												

* "Room condition" Temperature: 15 to 35°C, Relative humidity: 45 to 75%, Atmospheric pressure: 86 to 106kPa

Continued on the following page. 

Specifications and Test Methods

Continued from the preceding page.

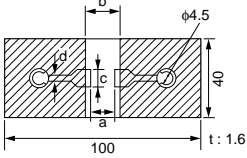
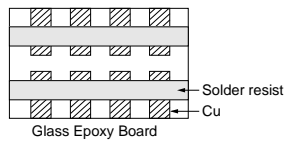
No.	Item	Specifications	Test Method															
12	Deflection	No cracking or marking defects should occur.	Solder the capacitor to the testing jig (glass epoxy board) shown in Fig. 2. Then apply a force in the direction shown in Fig. 3. The soldering should be done using the reflow method and should be conducted with care so that the soldering is uniform and free of defects such as heat shock.															
		 <table border="1" style="margin: 10px auto; border-collapse: collapse;"> <thead> <tr> <th rowspan="2">L×W (mm)</th> <th colspan="4">Dimension (mm)</th> </tr> <tr> <th>a</th> <th>b</th> <th>c</th> <th>d</th> </tr> </thead> <tbody> <tr> <td>4.5×2.0</td> <td>3.5</td> <td>7.0</td> <td>2.4</td> <td rowspan="2" style="text-align: center;">1.0</td> </tr> <tr> <td>4.5×3.2</td> <td>3.5</td> <td>7.0</td> <td>3.7</td> </tr> </tbody> </table> <p style="text-align: center;">Fig. 2</p>		L×W (mm)	Dimension (mm)				a	b	c	d	4.5×2.0	3.5	7.0	2.4	1.0	4.5×3.2
L×W (mm)	Dimension (mm)																	
	a	b	c	d														
4.5×2.0	3.5	7.0	2.4	1.0														
4.5×3.2	3.5	7.0	3.7															
13	Solderability of Termination	75% of the terminations are to be soldered evenly and continuously.	Immerse the capacitor in a solution of ethanol (JIS-K-8101) and rosin (JIS-K-5902) (25% rosin in weight proportion). Immerse in solder solution for 2±0.5 sec. Immersing speed: 25±2.5mm/s Temp. of solder: 245±5°C Lead Free Solder (Sn-3.0Ag-0.5Cu) 235±5°C H60A or H63A Eutectic Solder															
14	Resistance to Soldering Heat	Appearance	No marking defects															
		Capacitance Change	Within ±10%															
		D.F.	0.025 max.															
		I.R.	More than 1,000MΩ															
		Dielectric Strength	In accordance with item No.4															
			Preheat the capacitor as table. Immerse the capacitor in solder solution at 260±5°C for 10±1 sec. Let sit at room condition* for 24±2 hrs., then measure. •Immersing speed: 25±2.5mm/s •Pretreatment Perform a heat treatment at 150±18°C for 60±5 min. and then let sit for 24±2 hrs. at room condition*.															
			*Preheating <table border="1" style="margin: 10px auto; border-collapse: collapse;"> <thead> <tr> <th>Step</th> <th>Temperature</th> <th>Time</th> </tr> </thead> <tbody> <tr> <td>1</td> <td>100 to 120°C</td> <td>1 min.</td> </tr> <tr> <td>2</td> <td>170 to 200°C</td> <td>1 min.</td> </tr> </tbody> </table>	Step	Temperature	Time	1	100 to 120°C	1 min.	2	170 to 200°C	1 min.						
Step	Temperature	Time																
1	100 to 120°C	1 min.																
2	170 to 200°C	1 min.																
15	Temperature Cycle	Appearance	No marking defects															
		Capacitance Change	Within ±15%															
		D.F.	0.05 max.															
		I.R.	More than 3,000MΩ															
		Dielectric Strength	In accordance with item No.4															
			Fix the capacitor to the supporting jig (glass epoxy board) shown in Fig. 4. Perform the 5 cycles according to the 4 heat treatments listed in the following table. Let sit for 24±2 hrs. at room condition*, then measure. <table border="1" style="margin: 10px auto; border-collapse: collapse;"> <thead> <tr> <th>Step</th> <th>Temperature (°C)</th> <th>Time (min.)</th> </tr> </thead> <tbody> <tr> <td>1</td> <td>Min. Operating Temp.±3</td> <td>30±3</td> </tr> <tr> <td>2</td> <td>Room Temp.</td> <td>2 to 3</td> </tr> <tr> <td>3</td> <td>Max. Operating Temp.±2</td> <td>30±3</td> </tr> <tr> <td>4</td> <td>Room Temp.</td> <td>2 to 3</td> </tr> </tbody> </table>	Step	Temperature (°C)	Time (min.)	1	Min. Operating Temp.±3	30±3	2	Room Temp.	2 to 3	3	Max. Operating Temp.±2	30±3	4	Room Temp.	2 to 3
Step	Temperature (°C)	Time (min.)																
1	Min. Operating Temp.±3	30±3																
2	Room Temp.	2 to 3																
3	Max. Operating Temp.±2	30±3																
4	Room Temp.	2 to 3																
			•Pretreatment Perform a heat treatment at 150±18°C for 60±5 min. and then let sit for 24±2 hrs. at room condition*.															
			 <p style="text-align: center;">Fig. 4</p>															
16	Humidity (Steady State)	Appearance	No marking defects															
		Capacitance Change	Within ±15%															
		D.F.	0.05 max.															
		I.R.	More than 1,000MΩ															
		Dielectric Strength	In accordance with item No.4															
			Let the capacitor sit at 40±2°C and relative humidity of 90 to 95% for 500±24 hrs. Remove and let sit for 24±2 hrs. at room condition*, then measure. •Pretreatment Perform a heat treatment at 150±18°C for 60±5 min. and then let sit for 24±2 hrs. at room condition*.															

* "Room condition" Temperature: 15 to 35°C, Relative humidity: 45 to 75%, Atmospheric pressure: 86 to 106kPa

Continued on the following page.

Specifications and Test Methods

☐ Continued from the preceding page.

No.	Item	Specifications	Test Method
17	Appearance	No marking defects	Apply 110% of the rated voltage for 1,000 ^{±48} hrs. at maximum operating temperature ±3°C. Remove and let sit for 24 ±2 hrs. at room condition*, then measure. The charge/discharge current is less than 50mA. •Pretreatment Apply test voltage for 60±5 min. at test temperature. Remove and let sit for 24±2 hrs. at room condition*.
	Capacitance Change	Within ±20%	
	D.F.	0.05 max.	
	I.R.	More than 2,000MΩ	
	Dielectric Strength	In accordance with item No.4	

* "Room condition" Temperature: 15 to 35°C, Relative humidity: 45 to 75%, Atmospheric pressure: 86 to 106kPa

Chip Monolithic Ceramic Capacitors



Only for Camera Flash Circuit

■ Features

1. Suitable for the trigger of the flash circuit, because real capacitance is stable during operating voltage
2. The thin type fit for thinner camera.
3. Sn-plated external electrodes realizes good solderability.
4. For flow and reflow soldering

■ Applications

For strobe circuit

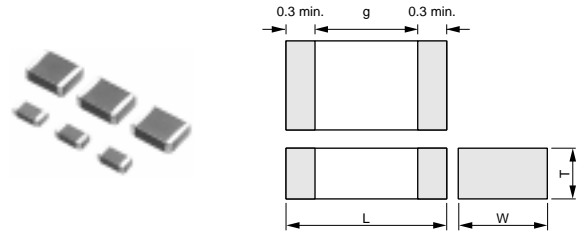

Part Number	Dimensions (mm)			
	L	W	T	g min.
GR731A	3.2 ±0.2	1.6 ±0.2	1.0 +0, -0.3	1.2
GR731B			1.25 +0, -0.3	
GR731C			1.6 ±0.2	

Part Number	Rated Voltage (V)	TC Code (Standard)	Capacitance (pF)	Length L (mm)	Width W (mm)	Thickness T (mm)	Electrode g min. (mm)	Electrode e (mm)
GR731AW0BB103KW01D	DC350	-	10000 ±10%	3.2	1.6	1.0	1.2	0.3 min.
GR731AW0BB153KW01D	DC350	-	15000 ±10%	3.2	1.6	1.0	1.2	0.3 min.
GR731BW0BB223KW01L	DC350	-	22000 ±10%	3.2	1.6	1.25	1.2	0.3 min.
GR731BW0BB333KW01L	DC350	-	33000 ±10%	3.2	1.6	1.25	1.2	0.3 min.
GR731CW0BB473KW03L	DC350	-	47000 ±10%	3.2	1.6	1.6	1.2	0.3 min.

Specifications and Test Methods

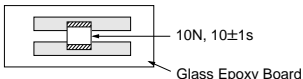
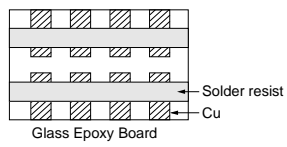
No.	Item	Specifications	Test Method												
1	Operating Temperature Range	-55 to +125°C	—												
2	Appearance	No defects or abnormalities	Visual inspection												
3	Dimensions	Within the specified dimensions	Using calipers												
4	Dielectric Strength	No defects or abnormalities	No failure should be observed when DC500V is applied between the terminations for 1 to 5 sec., provided the charge/discharge current is less than 50mA.												
5	Insulation Resistance (I.R.)	C ≥ 0.01μF: More than 100MΩ • μF C < 0.01μF: More than 10,000MΩ	The insulation resistance should be measured with DC250±50V and within 60±5 sec. of charging.												
6	Capacitance	Within the specified tolerance	The capacitance/D.F. should be measured at a frequency of 1±0.2kHz and a voltage of AC1±0.2V(r.m.s.)												
7	Dissipation Factor (D.F.)	0.025 max.													
8	Capacitance Temperature Characteristics	Cap. Change Within ±10% (Apply DC350V bias) Within ±33% (No DC bias) (Temp. Range : -55 to +125°C)	<p>The capacitance measurement should be made at each step specified in Table.</p> <table border="1"> <thead> <tr> <th>Step</th> <th>Temperature (°C)</th> </tr> </thead> <tbody> <tr> <td>1</td> <td>25±2</td> </tr> <tr> <td>2</td> <td>Min. Operating Temp.±3</td> </tr> <tr> <td>3</td> <td>25±2</td> </tr> <tr> <td>4</td> <td>Max. Operating Temp.±2</td> </tr> <tr> <td>5</td> <td>25±2</td> </tr> </tbody> </table> <p>•Pretreatment Perform a heat treatment at 150 ± 9.0 °C for 60±5 min. and then let sit for 24±2 hrs. at room condition*.</p>	Step	Temperature (°C)	1	25±2	2	Min. Operating Temp.±3	3	25±2	4	Max. Operating Temp.±2	5	25±2
Step	Temperature (°C)														
1	25±2														
2	Min. Operating Temp.±3														
3	25±2														
4	Max. Operating Temp.±2														
5	25±2														
9	Adhesive Strength of Termination	No removal of the terminations or other defect should occur.	<p>Solder the capacitor to the testing jig (glass epoxy board) shown in Fig. 1. Then apply 10N force in the direction of the arrow. The soldering should be done using the reflow method and should be conducted with care so that the soldering is uniform and free of defects such as heat shock.</p>  <p>Fig. 1</p>												
10	Appearance	No defects or abnormalities	<p>Solder the capacitor to the test jig (glass epoxy board). The capacitor should be subjected to a simple harmonic motion having a total amplitude of 1.5mm, the frequency being varied uniformly between the approximate limits of 10 and 55Hz. The frequency range, from 10 to 55Hz and return to 10Hz, should be traversed in approximately 1 min. This motion should be applied for a period of 2 hrs. in each of 3 mutually perpendicular directions (total of 6 hrs.).</p> 												
	Capacitance	Within the specified tolerance													
	D.F.	0.025 max.													

* "Room condition" Temperature: 15 to 35°C, Relative humidity: 45 to 75%, Atmospheric pressure: 86 to 106kPa

Continued on the following page. 

Specifications and Test Methods

Continued from the preceding page.

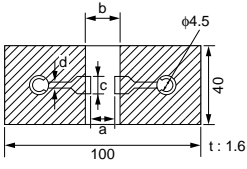
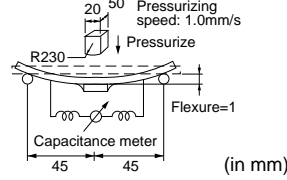
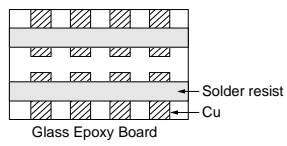
No.	Item	Specifications	Test Method															
11	Deflection	No cracking or marking defects should occur.	Solder the capacitor to the testing jig (glass epoxy board) shown in Fig. 2. Then apply a force in the direction shown in Fig. 3. The soldering should be done using the reflow method and should be conducted with care so that the soldering is uniform and free of defects such as heat shock.															
		 <table border="1" style="margin: 10px auto; border-collapse: collapse;"> <thead> <tr> <th rowspan="2">L×W (mm)</th> <th colspan="4">Dimension (mm)</th> </tr> <tr> <th>a</th> <th>b</th> <th>c</th> <th>d</th> </tr> </thead> <tbody> <tr> <td>3.2×1.6</td> <td>2.2</td> <td>5.0</td> <td>2.0</td> <td>1.0</td> </tr> </tbody> </table> <p style="text-align: center;">Fig. 2</p>		L×W (mm)	Dimension (mm)				a	b	c	d	3.2×1.6	2.2	5.0	2.0	1.0	
L×W (mm)	Dimension (mm)																	
	a	b	c	d														
3.2×1.6	2.2	5.0	2.0	1.0														
			 <p style="text-align: center;">Fig. 3</p>															
12	Solderability of Termination	75% of the terminations are to be soldered evenly and continuously.	Immerse the capacitor in a solution of ethanol (JIS-K-8101) and rosin (JIS-K-5902) (25% rosin in weight proportion). Immerse in solder solution for 2±0.5 sec. Immersing speed: 25±2.5mm/s Temp. of solder: 245±5°C Lead Free Solder (Sn-3.0Ag-0.5Cu) 235±5°C H60A or H63A Eutectic Solder															
13	Resistance to Soldering Heat	Appearance	No marking defects	Preheat the capacitor at 120 to 150°C* for 1 min. Immerse the capacitor in solder solution at 260±5°C for 10±1 sec. Let sit at room condition* for 24±2 hrs., then measure. •Immersing speed: 25±2.5mm/s •Pretreatment Perform a heat treatment at 150±1.8°C for 60±5 min. and then let sit for 24±2 hrs. at room condition*.														
		Capacitance Change	Within ±10%															
		D.F.	0.025 max.															
		I.R.	C≥0.01μF: More than 100MΩ • μF C<0.01μF: More than 10,000MΩ															
		Dielectric Strength	In accordance with item No.4															
14	Temperature Cycle	Appearance	No marking defects	Fix the capacitor to the supporting jig (glass epoxy board) shown in Fig. 4. Perform the 5 cycles according to the 4 heat treatments listed in the following table. Let sit for 24±2 hrs. at room condition*, then measure.														
		Capacitance Change	Within ±7.5%															
		D.F.	0.025 max.															
		I.R.	C≥0.01μF: More than 100MΩ • μF C<0.01μF: More than 10,000MΩ															
		Dielectric Strength	In accordance with item No.4															
			<table border="1" style="margin: 10px auto; border-collapse: collapse;"> <thead> <tr> <th>Step</th> <th>Temperature (°C)</th> <th>Time (min.)</th> </tr> </thead> <tbody> <tr> <td>1</td> <td>Min. Operating Temp.±3</td> <td>30±3</td> </tr> <tr> <td>2</td> <td>Room Temp.</td> <td>2 to 3</td> </tr> <tr> <td>3</td> <td>Max. Operating Temp.±2</td> <td>30±3</td> </tr> <tr> <td>4</td> <td>Room Temp.</td> <td>2 to 3</td> </tr> </tbody> </table> <p>•Pretreatment Perform a heat treatment at 150±1.8°C for 60±5 min. and then let sit for 24±2 hrs. at room condition*.</p>  <p style="text-align: center;">Fig. 4</p>	Step	Temperature (°C)	Time (min.)	1	Min. Operating Temp.±3	30±3	2	Room Temp.	2 to 3	3	Max. Operating Temp.±2	30±3	4	Room Temp.	2 to 3
Step	Temperature (°C)	Time (min.)																
1	Min. Operating Temp.±3	30±3																
2	Room Temp.	2 to 3																
3	Max. Operating Temp.±2	30±3																
4	Room Temp.	2 to 3																
15	Humidity (Steady State)	Appearance	No marking defects	Let the capacitor sit at 40±2°C and relative humidity of 90 to 95% for 500±24 hrs. Remove and let sit for 24±2 hrs. at room condition*, then measure. •Pretreatment Perform a heat treatment at 150±1.8°C for 60±5 min. and then let sit for 24±2 hrs. at room condition*.														
		Capacitance Change	Within ±15%															
		D.F.	0.05 max.															
		I.R.	C≥0.01μF: More than 10MΩ • μF C<0.01μF: More than 1,000MΩ															
		Dielectric Strength	In accordance with item No.4															

* "Room condition" Temperature: 15 to 35°C, Relative humidity: 45 to 75%, Atmospheric pressure: 86 to 106kPa

Continued on the following page.

Specifications and Test Methods

Continued from the preceding page.

No.	Item	Specifications	Test Method
16	Life	Appearance	No marking defects
		Capacitance Change	Within ±15%
		D.F.	0.05 max.
		I.R.	C≥0.01μF: More than 10MΩ • μF C<0.01μF: More than 1,000MΩ
		Dielectric Strength	In accordance with item No.4
			Apply DC350V for 1,000 ^{±4} hrs. at maximum operating temperature ±3°C. Remove and let sit for 24 ±2 hrs. at room condition*, then measure. The charge/discharge current is less than 50mA. •Pretreatment Apply test voltage for 60±5 min. at test temperature. Remove and let sit for 24±2 hrs. at room condition*.
17	Humidity Loading	Appearance	No marking defects
		Capacitance Change	Within ±15%
		D.F.	0.05 max.
		I.R.	C≥0.01μF: More than 10MΩ • μF C<0.01μF: More than 1,000MΩ
		Dielectric Strength	In accordance with item No.4
			Apply the rated voltage at 40±2°C and relative humidity of 90 to 95% for 500 ^{±2} hrs. Remove and let sit for 24±2 hrs. at room condition*, then measure. •Pretreatment Apply test voltage for 60±5 min. at test temperature. Remove and let sit for 24±2 hrs. at room condition*.

* "Room condition" Temperature: 15 to 35°C, Relative humidity: 45 to 75%, Atmospheric pressure: 86 to 106kPa

Chip Monolithic Ceramic Capacitors



AC250V (r.m.s.) Type (Which Meet Japanese Law)

■ Features

1. Chip monolithic ceramic capacitor for AC lines
2. A new monolithic structure for small, high capacitance capable of operating at high voltage levels
3. Sn-plated external electrodes realizes good solderability.
4. Only for reflow soldering
5. Capacitance 0.01 to 0.1uF for connecting lines and 470 to 4700pF for connecting lines to earth

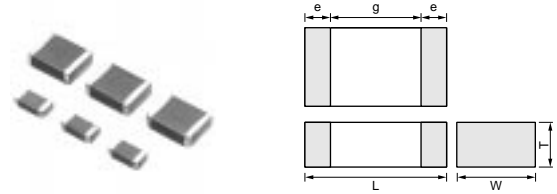

Part Number	Dimensions (mm)				
	L	W	T	e min.	g min.
GA242Q	4.5 ±0.3	2.0 ±0.2	1.5 +0, -0.3	0.3	2.5
GA243D	4.5 ±0.4	3.2 ±0.3	2.0 +0, -0.3		
GA243Q			1.5 +0, -0.3		3.2
GA255D	5.7 ±0.4	5.0 ±0.4	2.0 +0, -0.3		

■ Applications

Noise suppression filters for switching power supplies, telephones, facsimiles, modems

■ Reference standard

GA2 series obtains no safety approval.
 This series is based on JIS C 5102, JIS C 5150, and the standards of the electrical appliance and material safety law of Japan (separated table 4).

Part Number	Rated Voltage (V)	TC Code (Standard)	Capacitance	Length L (mm)	Width W (mm)	Thickness T (mm)	Electrode g min. (mm)	Electrode e (mm)
GA242QR7E2471MW01L	AC250 (r.m.s.)	X7R (EIA)	470pF ±20%	4.5	2.0	1.5	2.5	0.3 min.
GA242QR7E2102MW01L	AC250 (r.m.s.)	X7R (EIA)	1000pF ±20%	4.5	2.0	1.5	2.5	0.3 min.
GA243QR7E2222MW01L	AC250 (r.m.s.)	X7R (EIA)	2200pF ±20%	4.5	3.2	1.5	2.5	0.3 min.
GA243QR7E2332MW01L	AC250 (r.m.s.)	X7R (EIA)	3300pF ±20%	4.5	3.2	1.5	2.5	0.3 min.
GA243DR7E2472MW01L	AC250 (r.m.s.)	X7R (EIA)	4700pF ±20%	4.5	3.2	2.0	2.5	0.3 min.
GA243QR7E2103MW01L	AC250 (r.m.s.)	X7R (EIA)	10000pF ±20%	4.5	3.2	1.5	2.5	0.3 min.
GA243QR7E2223MW01L	AC250 (r.m.s.)	X7R (EIA)	22000pF ±20%	4.5	3.2	1.5	2.5	0.3 min.
GA243DR7E2473MW01L	AC250 (r.m.s.)	X7R (EIA)	47000pF ±20%	4.5	3.2	2.0	2.5	0.3 min.
GA255DR7E2104MW01L	AC250 (r.m.s.)	X7R (EIA)	0.10uF ±20%	5.7	5.0	2.0	3.2	0.3 min.

Specifications and Test Methods

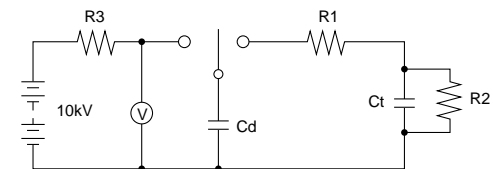
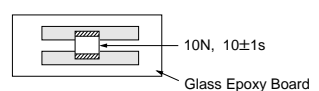
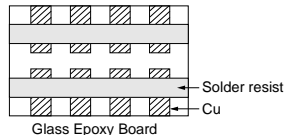
No.	Item	Specifications	Test Method												
1	Operating Temperature Range	-55 to +125°C	—												
2	Appearance	No defects or abnormalities	Visual inspection												
3	Dimensions	Within the specified dimensions	Using calipers												
4	Dielectric Strength	No defects or abnormalities	No failure should be observed when voltage in table is applied between the terminations for 60±1 sec., provided the charge/discharge current is less than 50mA. <table border="1"> <thead> <tr> <th>Nominal Capacitance</th> <th>Test voltage</th> </tr> </thead> <tbody> <tr> <td>C≥10,000pF</td> <td>AC575V (r.m.s.)</td> </tr> <tr> <td>C<10,000pF</td> <td>AC1500V (r.m.s.)</td> </tr> </tbody> </table>	Nominal Capacitance	Test voltage	C≥10,000pF	AC575V (r.m.s.)	C<10,000pF	AC1500V (r.m.s.)						
Nominal Capacitance	Test voltage														
C≥10,000pF	AC575V (r.m.s.)														
C<10,000pF	AC1500V (r.m.s.)														
5	Insulation Resistance (I.R.)	More than 2,000MΩ	The insulation resistance should be measured with DC500±50V and within 60±5 sec. of charging.												
6	Capacitance	Within the specified tolerance	The capacitance/D.F. should be measured at a frequency of 1±0.2kHz and a voltage of AC1±0.2V (r.m.s.)												
7	Dissipation Factor (D.F.)	0.025 max.													
8	Capacitance Temperature Characteristics	Cap. Change Within ±15% (Temp. Range: -55 to +125°C)	The capacitance measurement should be made at each step specified in Table. <table border="1"> <thead> <tr> <th>Step</th> <th>Temperature (°C)</th> </tr> </thead> <tbody> <tr> <td>1</td> <td>25±2</td> </tr> <tr> <td>2</td> <td>Min. Operating Temp.±3</td> </tr> <tr> <td>3</td> <td>25±2</td> </tr> <tr> <td>4</td> <td>Max. Operating Temp.±2</td> </tr> <tr> <td>5</td> <td>25±2</td> </tr> </tbody> </table> <p>•Pretreatment Perform a heat treatment at 150 ± 10°C for 60±5 min. and then let sit for 24±2 hrs. at room condition*.</p>	Step	Temperature (°C)	1	25±2	2	Min. Operating Temp.±3	3	25±2	4	Max. Operating Temp.±2	5	25±2
Step	Temperature (°C)														
1	25±2														
2	Min. Operating Temp.±3														
3	25±2														
4	Max. Operating Temp.±2														
5	25±2														
9	Discharge Test (Application: Nominal Capacitance C<10,000pF)	Appearance No defects or abnormalities	As in Fig., discharge is made 50 times at 5 sec. intervals from the capacitor (Cd) charged at DC voltage of specified.  Ct: Capacitor under test Cd: 0.001μF R1: 1,000Ω R2: 100MΩ R3: Surge resistance												
10	Adhesive Strength of Termination	No removal of the terminations or other defects should occur.	Solder the capacitor to the testing jig (glass epoxy board) shown in Fig. 1. Then apply 10N force in the direction of the arrow. The soldering should be done using the reflow method and should be conducted with care so that the soldering is uniform and free of defects such as heat shock.  Fig. 1												
11	Vibration Resistance	Appearance	No defects or abnormalities												
		Capacitance	Within the specified tolerance												
	D.F.	0.025 max.	Solder the capacitor to the test jig (glass epoxy board). The capacitor should be subjected to a simple harmonic motion having a total amplitude of 1.5mm, the frequency being varied uniformly between the approximate limits of 10 and 55Hz. The frequency range, from 10 to 55Hz and return to 10Hz, should be traversed in approximately 1 min. This motion should be applied for a period of 2 hrs. in each of 3 mutually perpendicular directions (total of 6 hrs.). 												

* "Room condition" Temperature: 15 to 35°C, Relative humidity: 45 to 75%, Atmospheric pressure: 86 to 106kPa

Continued on the following page. 

Specifications and Test Methods

Continued from the preceding page.

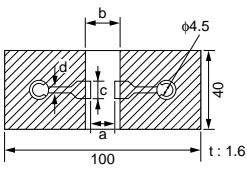
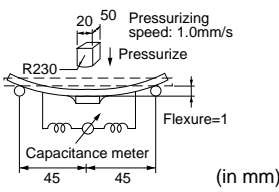
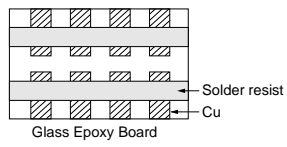
No.	Item	Specifications	Test Method																			
12	Deflection	No cracking or marking defects should occur.	Solder the capacitor to the testing jig (glass epoxy board) shown in Fig. 2. Then apply a force in the direction shown in Fig. 3. The soldering should be done using the reflow method and should be conducted with care so that the soldering is uniform and free of defects such as heat shock.																			
		 <table border="1" style="margin: 10px auto; border-collapse: collapse;"> <thead> <tr> <th rowspan="2">L×W (mm)</th> <th colspan="4">Dimension (mm)</th> </tr> <tr> <th>a</th> <th>b</th> <th>c</th> <th>d</th> </tr> </thead> <tbody> <tr> <td>4.5×2.0</td> <td>3.5</td> <td>7.0</td> <td>2.4</td> <td rowspan="3" style="text-align: center; vertical-align: middle;">1.0</td> </tr> <tr> <td>4.5×3.2</td> <td>3.5</td> <td>7.0</td> <td>3.7</td> </tr> <tr> <td>5.7×5.0</td> <td>4.5</td> <td>8.0</td> <td>5.6</td> </tr> </tbody> </table> <p style="text-align: center;">Fig. 2</p>		L×W (mm)	Dimension (mm)				a	b	c	d	4.5×2.0	3.5	7.0	2.4	1.0	4.5×3.2	3.5	7.0	3.7	5.7×5.0
L×W (mm)	Dimension (mm)																					
	a	b	c	d																		
4.5×2.0	3.5	7.0	2.4	1.0																		
4.5×3.2	3.5	7.0	3.7																			
5.7×5.0	4.5	8.0	5.6																			
13	Solderability of Termination	75% of the terminations are to be soldered evenly and continuously.	Immerse the capacitor in a solution of ethanol (JIS-K-8101) and rosin (JIS-K-5902) (25% rosin in weight proportion). Immerse in solder solution for 2±0.5 sec. Immersing speed: 25±2.5mm/s Temp. of solder: 245±5°C Lead Free Solder (Sn-3.0Ag-0.5Cu) 235±5°C H60A or H63A Eutectic Solder																			
14	Humidity Insulation	Appearance	No marking defects																			
		Capacitance Change	Within ±15%																			
		D.F.	0.05 max.																			
		I.R.	More than 1,000MΩ																			
		Dielectric Strength	In accordance with item No.4																			
 <p style="text-align: center;">Fig. 3</p>																						
15	Resistance to Soldering Heat	Appearance	No marking defects																			
		Capacitance Change	Within ±10%																			
		D.F.	0.025 max.																			
		I.R.	More than 2,000MΩ																			
		Dielectric Strength	In accordance with item No.4																			
Preheat the capacitor as table. Immerse the capacitor in solder solution at 260±5°C for 10±1 sec. Let sit at room condition* for 24±2 hrs., then measure. •Immersing speed: 25±2.5mm/s •Pretreatment Perform a heat treatment at 150±18°C for 60±5 min. and then let sit for 24±2 hrs. at room condition*. *Preheating																						
			<table border="1" style="margin: 0 auto; border-collapse: collapse;"> <thead> <tr> <th>Step</th> <th>Temperature</th> <th>Time</th> </tr> </thead> <tbody> <tr> <td style="text-align: center;">1</td> <td style="text-align: center;">100 to 120°C</td> <td style="text-align: center;">1 min.</td> </tr> <tr> <td style="text-align: center;">2</td> <td style="text-align: center;">170 to 200°C</td> <td style="text-align: center;">1 min.</td> </tr> </tbody> </table>	Step	Temperature	Time	1	100 to 120°C	1 min.	2	170 to 200°C	1 min.										
Step	Temperature	Time																				
1	100 to 120°C	1 min.																				
2	170 to 200°C	1 min.																				
16	Temperature Cycle	Appearance	No marking defects																			
		Capacitance Change	Within ±15%																			
		D.F.	0.05 max.																			
		I.R.	More than 2,000MΩ																			
		Dielectric Strength	In accordance with item No.4																			
Fix the capacitor to the supporting jig (glass epoxy board) shown in Fig. 4. Perform the 5 cycles according to the 4 heat treatments listed in the following table. Let sit for 24±2 hrs. at room condition*, then measure.																						
			<table border="1" style="margin: 0 auto; border-collapse: collapse;"> <thead> <tr> <th>Step</th> <th>Temperature (°C)</th> <th>Time (min.)</th> </tr> </thead> <tbody> <tr> <td style="text-align: center;">1</td> <td style="text-align: center;">Min. Operating Temp.±3</td> <td style="text-align: center;">30±3</td> </tr> <tr> <td style="text-align: center;">2</td> <td style="text-align: center;">Room Temp.</td> <td style="text-align: center;">2 to 3</td> </tr> <tr> <td style="text-align: center;">3</td> <td style="text-align: center;">Max. Operating Temp.±2</td> <td style="text-align: center;">30±3</td> </tr> <tr> <td style="text-align: center;">4</td> <td style="text-align: center;">Room Temp.</td> <td style="text-align: center;">2 to 3</td> </tr> </tbody> </table>	Step	Temperature (°C)	Time (min.)	1	Min. Operating Temp.±3	30±3	2	Room Temp.	2 to 3	3	Max. Operating Temp.±2	30±3	4	Room Temp.	2 to 3				
Step	Temperature (°C)	Time (min.)																				
1	Min. Operating Temp.±3	30±3																				
2	Room Temp.	2 to 3																				
3	Max. Operating Temp.±2	30±3																				
4	Room Temp.	2 to 3																				
•Pretreatment Perform a heat treatment at 150±18°C for 60±5 min. and then let sit for 24±2 hrs. at room condition*.																						
 <p style="text-align: center;">Fig. 4</p>																						

* "Room condition" Temperature: 15 to 35°C, Relative humidity: 45 to 75%, Atmospheric pressure: 86 to 106kPa

Continued on the following page.

Specifications and Test Methods

Continued from the preceding page.

No.	Item	Specifications	Test Method									
17	Humidity (Steady State)	Appearance	No marking defects									
		Capacitance Change	Within $\pm 15\%$									
		D.F.	0.05 max.									
		I.R.	More than 1,000M Ω									
		Dielectric Strength	In accordance with item No.4									
			Let the capacitor sit at $40\pm 2^\circ\text{C}$ and relative humidity of 90 to 95% for 500 ± 24 hrs. Remove and let sit for 24 ± 2 hrs. at room condition*, then measure. •Pretreatment Perform a heat treatment at $150\pm 18^\circ\text{C}$ for 60 ± 5 min. and then let sit for 24 ± 2 hrs. at room condition*.									
18	Life	Appearance	No marking defects									
		Capacitance Change	Within $\pm 20\%$									
		D.F.	0.05 max.									
		I.R.	More than 1,000M Ω									
		Dielectric Strength	In accordance with item No.4									
			Apply voltage and time as Table at $85\pm 2^\circ\text{C}$. Remove and let sit for 24 ± 2 hrs. at room condition*, then measure. The charge / discharge current is less than 50mA. <table border="1" style="margin-left: auto; margin-right: auto;"> <thead> <tr> <th>Nominal Capacitance</th> <th>Test Time</th> <th>Test voltage</th> </tr> </thead> <tbody> <tr> <td>$\geq 10,000\text{pF}$</td> <td>$1,000\pm 48$ hrs.</td> <td>AC300V (r.m.s.)</td> </tr> <tr> <td>$< 10,000\text{pF}$</td> <td>$1,500\pm 48$ hrs.</td> <td>AC500V (r.m.s.)*</td> </tr> </tbody> </table> * Except that once each hour the voltage is increased to AC1,000V (r.m.s.) for 0.1 sec. •Pretreatment Apply test voltage for 60 ± 5 min. at test temperature. Remove and let sit for 24 ± 2 hrs. at room condition*.	Nominal Capacitance	Test Time	Test voltage	$\geq 10,000\text{pF}$	$1,000\pm 48$ hrs.	AC300V (r.m.s.)	$< 10,000\text{pF}$	$1,500\pm 48$ hrs.	AC500V (r.m.s.)*
Nominal Capacitance	Test Time	Test voltage										
$\geq 10,000\text{pF}$	$1,000\pm 48$ hrs.	AC300V (r.m.s.)										
$< 10,000\text{pF}$	$1,500\pm 48$ hrs.	AC500V (r.m.s.)*										
19	Humidity Loading	Appearance	No marking defects									
		Capacitance Change	Within $\pm 15\%$									
		D.F.	0.05 max.									
		I.R.	More than 1,000M Ω									
		Dielectric Strength	In accordance with item No.4									
			Apply the rated voltage at $40\pm 2^\circ\text{C}$ and relative humidity of 90 to 95% for 500 ± 24 hrs. Remove and let sit for 24 ± 2 hrs. at room condition*, then measure. •Pretreatment Apply test voltage for 60 ± 5 min. at test temperature. Remove and let sit for 24 ± 2 hrs. at room condition*.									

* "Room condition" Temperature: 15 to 35°C, Relative humidity: 45 to 75%, Atmospheric pressure: 86 to 106kPa

Chip Monolithic Ceramic Capacitors



Safety Standard Recognized Type GC (UL, IEC60384-14 Class X1/Y2)

■ Features

1. Chip monolithic ceramic capacitor (certified as conforming to safety standards) for AC lines
2. A new monolithic structure for small, high capacitance capable of operating at high voltage levels
3. Compared to lead type capacitors, this new capacitor is greatly downsized and low-profiled to 1/10 or less in volume, and 1/4 or less in height.
4. The type GC can be used as an X1-class and Y2-class capacitor, line-by-pass capacitor of UL1414.
5. +125 degree C guaranteed
6. Only for reflow soldering

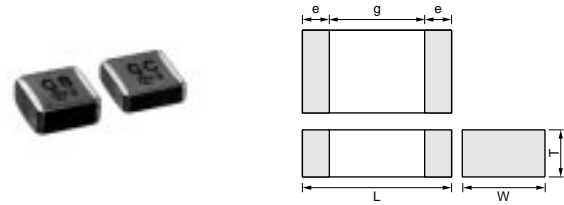

Part Number	Dimensions (mm)				
	L	W	T	e min.	g min.
GA355D	5.7 ±0.4	5.0 ±0.4	2.0 ±0.3	0.3	4.0

■ Applications

1. Ideal for use as Y capacitor or X capacitor for various switching power supplies
2. Ideal for modem applications

■ Standard Recognition

	Standard No.	Status of Recognition		Rated Voltage
		Type GB	Type GC	
UL	UL1414	—	◎*	AC250V (r.m.s.)
BSI	EN132400	—	◎	
VDE		◎	◎	
SEV		◎	◎	
SEMKO		◎	◎	
EN132400 Class		X2	X1, Y2	

*: Line By-pass only

Part Number	Rated Voltage (V)	TC Code (Standard)	Capacitance (pF)	Length L (mm)	Width W (mm)	Thickness T (mm)	Electrode g min. (mm)	Electrode e (mm)
GA355DR7GC101KY02L	AC250 (r.m.s.)	X7R (EIA)	100 ±10%	5.7	5.0	2.0	4.0	0.3 min.
GA355DR7GC151KY02L	AC250 (r.m.s.)	X7R (EIA)	150 ±10%	5.7	5.0	2.0	4.0	0.3 min.
GA355DR7GC221KY02L	AC250 (r.m.s.)	X7R (EIA)	220 ±10%	5.7	5.0	2.0	4.0	0.3 min.
GA355DR7GC331KY02L	AC250 (r.m.s.)	X7R (EIA)	330 ±10%	5.7	5.0	2.0	4.0	0.3 min.

Chip Monolithic Ceramic Capacitors



Safety Standard Recognized Type GD (IEC60384-14 Class Y3)

■ Features

1. Available for equipment based on IEC/EN60950 and UL1950
2. The type GD can be used as a Y3-class capacitor.
3. A new monolithic structure for small, high capacitance capable of operating at high voltage levels
4. +125 degree C guaranteed
5. Only for reflow soldering
6. The low-profile type (thickness: 1.5mm max.) is available. Fit for use on thinner type equipment.

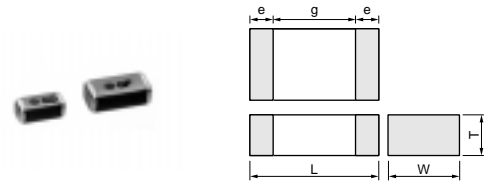

Part Number	Dimensions (mm)				
	L	W	T	e min.	g min.
GA342A	4.5 ±0.3	2.0 ±0.2	1.0 +0, -0.3	0.3	2.5
GA342D			2.0 ±0.3		
GA342Q			1.5 +0, -0.3		
GA343D	4.5 ±0.4	3.2 ±0.3	2.0 +0, -0.3		
GA343Q			1.5 +0, -0.3		

■ Applications

1. Ideal for use on line filters and couplings for DAA modems without transformers
2. Ideal for use on line filters for information equipment

■ Standard Recognition

	Standard No.	Class	Status of Recognition	Rated Voltage
			Type GD	
SEMKO	EN132400	Y3	⊙	AC250V(r.m.s.)

Applications

Size	Switching power supplies	Communication network devices such as a modem
4.5×3.2mm and under	—	⊙

Part Number	Rated Voltage (V)	TC Code (Standard)	Capacitance (pF)	Length L (mm)	Width W (mm)	Thickness T (mm)	Electrode g min. (mm)	Electrode e (mm)
GA342D1XGD100JY02L	AC250 (r.m.s.)	SL (JIS)	10 ±5%	4.5	2.0	2.0	2.5	0.3 min.
GA342D1XGD120JY02L	AC250 (r.m.s.)	SL (JIS)	12 ±5%	4.5	2.0	2.0	2.5	0.3 min.
GA342D1XGD150JY02L	AC250 (r.m.s.)	SL (JIS)	15 ±5%	4.5	2.0	2.0	2.5	0.3 min.
GA342D1XGD180JY02L	AC250 (r.m.s.)	SL (JIS)	18 ±5%	4.5	2.0	2.0	2.5	0.3 min.
GA342D1XGD220JY02L	AC250 (r.m.s.)	SL (JIS)	22 ±5%	4.5	2.0	2.0	2.5	0.3 min.
GA342A1XGD270JW31L	AC250 (r.m.s.)	SL (JIS)	27 ±5%	4.5	2.0	1.0	2.5	0.3 min.
GA342A1XGD330JW31L	AC250 (r.m.s.)	SL (JIS)	33 ±5%	4.5	2.0	1.0	2.5	0.3 min.
GA342A1XGD390JW31L	AC250 (r.m.s.)	SL (JIS)	39 ±5%	4.5	2.0	1.0	2.5	0.3 min.
GA342A1XGD470JW31L	AC250 (r.m.s.)	SL (JIS)	47 ±5%	4.5	2.0	1.0	2.5	0.3 min.
GA342A1XGD560JW31L	AC250 (r.m.s.)	SL (JIS)	56 ±5%	4.5	2.0	1.0	2.5	0.3 min.
GA342A1XGD680JW31L	AC250 (r.m.s.)	SL (JIS)	68 ±5%	4.5	2.0	1.0	2.5	0.3 min.
GA342A1XGD820JW31L	AC250 (r.m.s.)	SL (JIS)	82 ±5%	4.5	2.0	1.0	2.5	0.3 min.
GA342QR7GD101KW01L	AC250 (r.m.s.)	X7R (EIA)	100 ±10%	4.5	2.0	1.5	2.5	0.3 min.
GA342QR7GD151KW01L	AC250 (r.m.s.)	X7R (EIA)	150 ±10%	4.5	2.0	1.5	2.5	0.3 min.
GA342QR7GD221KW01L	AC250 (r.m.s.)	X7R (EIA)	220 ±10%	4.5	2.0	1.5	2.5	0.3 min.
GA342QR7GD331KW01L	AC250 (r.m.s.)	X7R (EIA)	330 ±10%	4.5	2.0	1.5	2.5	0.3 min.
GA342QR7GD471KW01L	AC250 (r.m.s.)	X7R (EIA)	470 ±10%	4.5	2.0	1.5	2.5	0.3 min.
GA342QR7GD681KW01L	AC250 (r.m.s.)	X7R (EIA)	680 ±10%	4.5	2.0	1.5	2.5	0.3 min.
GA342QR7GD102KW01L	AC250 (r.m.s.)	X7R (EIA)	1000 ±10%	4.5	2.0	1.5	2.5	0.3 min.
GA342QR7GD152KW01L	AC250 (r.m.s.)	X7R (EIA)	1500 ±10%	4.5	2.0	1.5	2.5	0.3 min.
GA343QR7GD182KW01L	AC250 (r.m.s.)	X7R (EIA)	1800 ±10%	4.5	3.2	1.5	2.5	0.3 min.
GA343QR7GD222KW01L	AC250 (r.m.s.)	X7R (EIA)	2200 ±10%	4.5	3.2	1.5	2.5	0.3 min.
GA343DR7GD472KW01L	AC250 (r.m.s.)	X7R (EIA)	4700 ±10%	4.5	3.2	2.0	2.5	0.3 min.

Chip Monolithic Ceramic Capacitors



Safety Standard Recognized Type GF (IEC60384-14 Class Y2, X1/Y2)

■ Features

1. Available for equipment based on IEC/EN60950 and UL1950. Besides, the GA352/355 types are available for equipment based on IEC/EN60065, UL1492, and UL6500
2. The type GF can be used as a Y2-class capacitor.
3. A new monolithic structure for small, high capacitance capable of operating at high voltage levels
4. +125 degree C guaranteed
5. Only for reflow soldering
6. The low-profile type (thickness: 1.5mm max.) is available. Fit for use on thinner type equipment.

■ Applications

1. Ideal for use on line filters and couplings for DAA modems without transformers
2. Ideal for use on line filters for information equipment
3. Ideal for use as Y capacitor or X capacitor for various switching power supplies (GA352/355 types only)

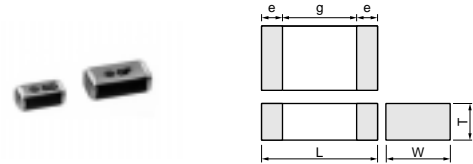

Part Number	Dimensions (mm)					
	L	W	T	e min.	g min.	
GA342A	4.5 ±0.3	2.0 ±0.2	1.0 +0, -0.3	0.3	2.5	
GA342D			2.0 ±0.2*			
GA342Q			1.5 +0, -0.3			
GA352Q	5.7 ±0.4	5.0 ±0.4	1.5 +0, -0.3			4.0
GA355D			2.0 +0, -0.3			
GA355Q			1.5 +0, -0.3			

* GA342D1X : 2.0±0.3

■ Standard Recognition

	Standard No.	Class	Status of Recognition		Rated Voltage
			Type GF		
			Size : 4.5x2.0mm	Size : 5.7x2.8mm and over	
UL	UL1414	X1, Y2	—	⊙	AC250V (r.m.s.)
SEMKO	EN132400	Y2	⊙	⊙	

Applications

Size	Switching power supplies	Communication network devices such as a modem
4.5x2.0mm	—	⊙
5.7x2.8mm and over	⊙	⊙

Part Number	Rated Voltage (V)	TC Code (Standard)	Capacitance (pF)	Length L (mm)	Width W (mm)	Thickness T (mm)	Electrode g min. (mm)	Electrode e (mm)
GA342D1XGF100JY02L	AC250 (r.m.s.)	SL (JIS)	10 ±5%	4.5	2.0	2.0	2.5	0.3 min.
GA342D1XGF120JY02L	AC250 (r.m.s.)	SL (JIS)	12 ±5%	4.5	2.0	2.0	2.5	0.3 min.
GA342D1XGF150JY02L	AC250 (r.m.s.)	SL (JIS)	15 ±5%	4.5	2.0	2.0	2.5	0.3 min.
GA342D1XGF180JY02L	AC250 (r.m.s.)	SL (JIS)	18 ±5%	4.5	2.0	2.0	2.5	0.3 min.
GA342D1XGF220JY02L	AC250 (r.m.s.)	SL (JIS)	22 ±5%	4.5	2.0	2.0	2.5	0.3 min.
GA342A1XGF270JW31L	AC250 (r.m.s.)	SL (JIS)	27 ±5%	4.5	2.0	1.0	2.5	0.3 min.
GA342A1XGF330JW31L	AC250 (r.m.s.)	SL (JIS)	33 ±5%	4.5	2.0	1.0	2.5	0.3 min.
GA342A1XGF390JW31L	AC250 (r.m.s.)	SL (JIS)	39 ±5%	4.5	2.0	1.0	2.5	0.3 min.
GA342A1XGF470JW31L	AC250 (r.m.s.)	SL (JIS)	47 ±5%	4.5	2.0	1.0	2.5	0.3 min.
GA342A1XGF560JW31L	AC250 (r.m.s.)	SL (JIS)	56 ±5%	4.5	2.0	1.0	2.5	0.3 min.
GA342A1XGF680JW31L	AC250 (r.m.s.)	SL (JIS)	68 ±5%	4.5	2.0	1.0	2.5	0.3 min.
GA342A1XGF820JW31L	AC250 (r.m.s.)	SL (JIS)	82 ±5%	4.5	2.0	1.0	2.5	0.3 min.
GA342QR7GF101KW01L	AC250 (r.m.s.)	X7R (EIA)	100 ±10%	4.5	2.0	1.5	2.5	0.3 min.
GA342QR7GF151KW01L	AC250 (r.m.s.)	X7R (EIA)	150 ±10%	4.5	2.0	1.5	2.5	0.3 min.
GA342DR7GF221KW02L	AC250 (r.m.s.)	X7R (EIA)	220 ±10%	4.5	2.0	2.0	2.5	0.3 min.
GA342DR7GF331KW02L	AC250 (r.m.s.)	X7R (EIA)	330 ±10%	4.5	2.0	2.0	2.5	0.3 min.
GA352QR7GF471KW01L	AC250 (r.m.s.)	X7R (EIA)	470 ±10%	5.7	2.8	1.5	4.0	0.3 min.
GA352QR7GF681KW01L	AC250 (r.m.s.)	X7R (EIA)	680 ±10%	5.7	2.8	1.5	4.0	0.3 min.
GA352QR7GF102KW01L	AC250 (r.m.s.)	X7R (EIA)	1000 ±10%	5.7	2.8	1.5	4.0	0.3 min.
GA352QR7GF152KW01L	AC250 (r.m.s.)	X7R (EIA)	1500 ±10%	5.7	2.8	1.5	4.0	0.3 min.
GA355QR7GF182KW01L	AC250 (r.m.s.)	X7R (EIA)	1800 ±10%	5.7	5.0	1.5	4.0	0.3 min.
GA355QR7GF222KW01L	AC250 (r.m.s.)	X7R (EIA)	2200 ±10%	5.7	5.0	1.5	4.0	0.3 min.
GA355QR7GF332KW01L	AC250 (r.m.s.)	X7R (EIA)	3300 ±10%	5.7	5.0	1.5	4.0	0.3 min.
GA355DR7GF472KW01L	AC250 (r.m.s.)	X7R (EIA)	4700 ±10%	5.7	5.0	2.0	4.0	0.3 min.

Chip Monolithic Ceramic Capacitors



Safety Standard Recognized Type GB (IEC60384-14 Class X2)

■ Features

1. The type GB can be used as an X2-class capacitor.
2. Chip monolithic ceramic capacitor (certified as conforming to safety standards) for AC lines
3. A new monolithic structure for small, high capacitance capable of operating at high voltage levels
4. Compared to lead type capacitors, this new capacitor is greatly downsized and low-profiled to 1/10 or less in volume, and 1/4 or less in height.
5. +125 degree C guaranteed
6. Only for reflow soldering

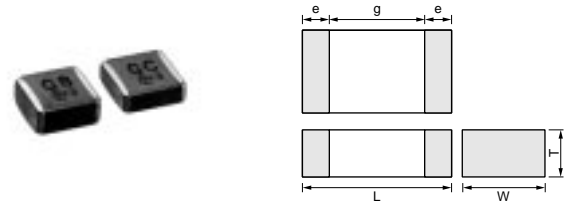

Part Number	Dimensions (mm)				
	L	W	T	e min.	g min.
GA355D	5.7 ±0.4	5.0 ±0.4	2.0 ±0.3	0.3	4.0
GA355X			2.7 ±0.3		

■ Applications

Ideal for use as X capacitor for various switching power supplies

■ Standard Recognition

	Standard No.	Status of Recognition		Rated Voltage
		Type GB	Type GC	
UL	UL1414	—	◎*	AC250V (r.m.s.)
BSI	EN132400	—	◎	
VDE		◎	◎	
SEV		◎	◎	
SEMKO		◎	◎	
EN132400 Class		X2	X1, Y2	

*: Line By-pass only

Part Number	Rated Voltage (V)	TC Code (Standard)	Capacitance (pF)	Length L (mm)	Width W (mm)	Thickness T (mm)	Electrode g min. (mm)	Electrode e (mm)
GA355DR7GB103KY02L	AC250 (r.m.s.)	X7R (EIA)	10000 ±10%	5.7	5.0	2.0	4.0	0.3 min.
GA355DR7GB153KY02L	AC250 (r.m.s.)	X7R (EIA)	15000 ±10%	5.7	5.0	2.0	4.0	0.3 min.
GA355DR7GB223KY02L	AC250 (r.m.s.)	X7R (EIA)	22000 ±10%	5.7	5.0	2.0	4.0	0.3 min.
GA355XR7GB333KY06L	AC250 (r.m.s.)	X7R (EIA)	33000 ±10%	5.7	5.0	2.7	4.0	0.3 min.

GA3 Series Specifications and Test Methods

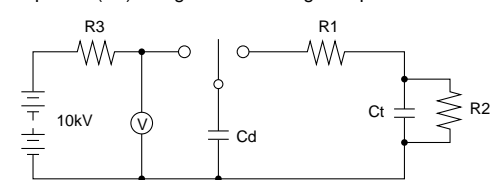
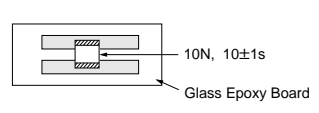
No.	Item	Specifications	Test Method																				
1	Operating Temperature Range	-55 to +125°C	-																				
2	Appearance	No defects or abnormalities	Visual inspection																				
3	Dimensions	Within the specified dimensions	Using calipers																				
4	Dielectric Strength	No defects or abnormalities	No failure should be observed when voltage in table is applied between the terminations for 60±1 sec., provided the charge/discharge current is less than 50mA. <table border="1" style="margin-left: auto; margin-right: auto; border-collapse: collapse;"> <thead> <tr> <th colspan="2" style="text-align: center;">Test Voltage</th> </tr> </thead> <tbody> <tr> <td style="text-align: center;">Type GB</td> <td style="text-align: center;">DC1075V</td> </tr> <tr> <td style="text-align: center;">Type GC/GD/GF</td> <td style="text-align: center;">AC1500V (r.m.s.)</td> </tr> </tbody> </table>	Test Voltage		Type GB	DC1075V	Type GC/GD/GF	AC1500V (r.m.s.)														
Test Voltage																							
Type GB	DC1075V																						
Type GC/GD/GF	AC1500V (r.m.s.)																						
5	Pulse Voltage (Application: Type GD/GF)	No self healing breakdowns or flash-overs have taken place in the capacitor.	10 impulse of alternating polarity is subjected. (5 impulse for each polarity) The interval between impulse is 60 sec. Applied Voltage: 2.5kV zero to peak																				
6	Insulation Resistance (I.R.)	More than 6,000MΩ	The insulation resistance should be measured with DC500±50V and within 60±5 sec. of charging.																				
7	Capacitance	Within the specified tolerance																					
8	Dissipation Factor (D.F.) Q	<table border="1" style="margin-left: auto; margin-right: auto; border-collapse: collapse;"> <thead> <tr> <th style="text-align: center;">Char.</th> <th style="text-align: center;">Specification</th> </tr> </thead> <tbody> <tr> <td style="text-align: center;">X7R</td> <td style="text-align: center;">D.F. ≤ 0.025</td> </tr> <tr> <td style="text-align: center;">SL</td> <td style="text-align: center;">Q ≥ 400+20C*2 (C < 30pF) Q ≥ 1000 (C ≥ 30pF)</td> </tr> </tbody> </table>	Char.	Specification	X7R	D.F. ≤ 0.025	SL	Q ≥ 400+20C*2 (C < 30pF) Q ≥ 1000 (C ≥ 30pF)	The capacitance/Q/D.F. should be measured at a frequency of 1±0.2kHz (SL char.: 1±0.2MHz) and a voltage of AC1±0.2V (r.m.s.).														
Char.	Specification																						
X7R	D.F. ≤ 0.025																						
SL	Q ≥ 400+20C*2 (C < 30pF) Q ≥ 1000 (C ≥ 30pF)																						
9	Capacitance Temperature Characteristics	<table border="1" style="margin-left: auto; margin-right: auto; border-collapse: collapse;"> <thead> <tr> <th style="text-align: center;">Char.</th> <th style="text-align: center;">Capacitance Change</th> </tr> </thead> <tbody> <tr> <td style="text-align: center;">X7R</td> <td style="text-align: center;">Within ±15%</td> </tr> </tbody> </table> Temperature characteristic guarantee is -55 to +125°C <table border="1" style="margin-left: auto; margin-right: auto; border-collapse: collapse;"> <thead> <tr> <th style="text-align: center;">Char.</th> <th style="text-align: center;">Temperature Coefficient</th> </tr> </thead> <tbody> <tr> <td style="text-align: center;">SL</td> <td style="text-align: center;">+350 to -1000ppm/°C</td> </tr> </tbody> </table> Temperature characteristic guarantee is +20 to +85°C	Char.	Capacitance Change	X7R	Within ±15%	Char.	Temperature Coefficient	SL	+350 to -1000ppm/°C	The capacitance measurement should be made at each step specified in Table. <table border="1" style="margin-left: auto; margin-right: auto; border-collapse: collapse;"> <thead> <tr> <th style="text-align: center;">Step</th> <th style="text-align: center;">Temperature (°C)</th> </tr> </thead> <tbody> <tr> <td style="text-align: center;">1</td> <td style="text-align: center;">25±2 (20±2 for SL char.)</td> </tr> <tr> <td style="text-align: center;">2</td> <td style="text-align: center;">Min. Operating Temp. ±3</td> </tr> <tr> <td style="text-align: center;">3</td> <td style="text-align: center;">25±2 (20±2 for SL char.)</td> </tr> <tr> <td style="text-align: center;">4</td> <td style="text-align: center;">Max. Operating Temp. ±2</td> </tr> <tr> <td style="text-align: center;">5</td> <td style="text-align: center;">25±2 (20±2 for SL char.)</td> </tr> </tbody> </table> SL char. : The capacitance should be measured at even 85°C between step 3 and step 4. •Pretreatment for X7R char. Perform a heat treatment at 150 ± 1.8 °C for 60±5 min. and then let sit for 24±2 hrs. at room condition*1.	Step	Temperature (°C)	1	25±2 (20±2 for SL char.)	2	Min. Operating Temp. ±3	3	25±2 (20±2 for SL char.)	4	Max. Operating Temp. ±2	5	25±2 (20±2 for SL char.)
Char.	Capacitance Change																						
X7R	Within ±15%																						
Char.	Temperature Coefficient																						
SL	+350 to -1000ppm/°C																						
Step	Temperature (°C)																						
1	25±2 (20±2 for SL char.)																						
2	Min. Operating Temp. ±3																						
3	25±2 (20±2 for SL char.)																						
4	Max. Operating Temp. ±2																						
5	25±2 (20±2 for SL char.)																						
10	Appearance	No defects or abnormalities	As in Fig., discharge is made 50 times at 5 sec. intervals from the capacitor (Cd) charged at DC voltage of specified. <div style="text-align: center;">  <p style="font-size: small;">Ct: Capacitor under test Cd: 0.001μF R1: 1,000Ω R2: 100MΩ R3: Surge resistance</p> </div>																				
	I.R.	More than 1,000MΩ																					
	Dielectric Strength	In accordance with item No.4																					
11	Adhesive Strength of Termination	No removal of the terminations or other defect should occur.	Solder the capacitor to the testing jig (glass epoxy board) shown in Fig. 1. Then apply 10N force in the direction of the arrow. The soldering should be done using the reflow method and should be conducted with care so that the soldering is uniform and free of defects such as heat shock. <div style="text-align: center;">  <p style="font-size: small;">10N, 10±1s Glass Epoxy Board</p> </div> <p style="text-align: center;">Fig. 1</p>																				

*1 "Room condition" Temperature: 15 to 35°C, Relative humidity: 45 to 75%, Atmospheric pressure: 86 to 106kPa
 *2 "C" expresses nominal capacitance value (pF).

Continued on the following page.

GA3 Series Specifications and Test Methods

Continued from the preceding page.

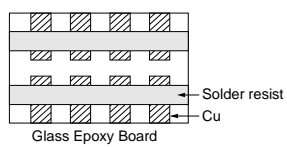
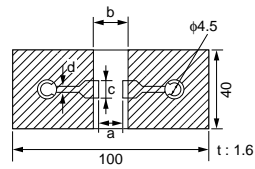
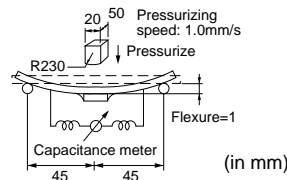
No.	Item	Specifications	Test Method																								
12	Appearance	No defects or abnormalities	Solder the capacitor to the test jig (glass epoxy board). The capacitor should be subjected to a simple harmonic motion having a total amplitude of 1.5mm, the frequency being varied uniformly between the approximate limits of 10 and 55Hz. The frequency range, from 10 to 55Hz and return to 10Hz, should be traversed in approximately 1 min. This motion should be applied for a period of 2 hrs. in each of 3 mutually perpendicular directions (total of 6 hrs.).																								
	Capacitance	Within the specified tolerance																									
13	Vibration Resistance	D.F.																									
		Q																									
13	Deflection	No cracking or marking defects should occur.	Solder the capacitor to the testing jig (glass epoxy board) shown in Fig. 2. Then apply a force in the direction shown in Fig. 3. The soldering should be done using the reflow method and should be conducted with care so that the soldering is uniform and free of defects such as heat shock.																								
		 <table border="1" data-bbox="367 884 877 1030"> <thead> <tr> <th>LxW (mm)</th> <th colspan="4">Dimension (mm)</th> </tr> <tr> <th></th> <th>a</th> <th>b</th> <th>c</th> <th>d</th> </tr> </thead> <tbody> <tr> <td>4.5x2.0</td> <td>3.5</td> <td>7.0</td> <td>2.4</td> <td rowspan="4">1.0</td> </tr> <tr> <td>4.5x3.2</td> <td>3.5</td> <td>7.0</td> <td>3.7</td> </tr> <tr> <td>5.7x2.8</td> <td>4.5</td> <td>8.0</td> <td>3.2</td> </tr> <tr> <td>5.7x5.0</td> <td>4.5</td> <td>8.0</td> <td>5.6</td> </tr> </tbody> </table> <p>Fig. 2</p>		LxW (mm)	Dimension (mm)					a	b	c	d	4.5x2.0	3.5	7.0	2.4	1.0	4.5x3.2	3.5	7.0	3.7	5.7x2.8	4.5	8.0	3.2	5.7x5.0
LxW (mm)	Dimension (mm)																										
	a	b	c	d																							
4.5x2.0	3.5	7.0	2.4	1.0																							
4.5x3.2	3.5	7.0	3.7																								
5.7x2.8	4.5	8.0	3.2																								
5.7x5.0	4.5	8.0	5.6																								
14	Solderability of Termination	75% of the terminations are to be soldered evenly and continuously.	 <p>Fig. 3</p>																								
		Immerse the capacitor in a solution of ethanol (JIS-K-8101) and rosin (JIS-K-5902) (25% rosin in weight proportion). Immerse in solder solution for 2±0.5 sec. Immersing speed: 25±2.5mm/s Temp. of solder: 245±5°C Lead Free Solder (Sn-3.0Ag-0.5Cu) 235±5°C H60A or H63A Eutectic Solder																									
15	Appearance	No marking defects	Preheat the capacitor as table. Immerse the capacitor in solder solution at 260±5°C for 10±1 sec. Let sit at room condition*1 for 24±2 hrs., then measure. •Immersing speed: 25±2.5mm/s •Pretreatment for X7R char. Perform a heat treatment at 150±18°C for 60±5 min. and then let sit for 24±2 hrs. at room condition*1.																								
	Capacitance Change	<table border="1" data-bbox="351 1288 702 1388"> <thead> <tr> <th>Char.</th> <th>Capacitance Change</th> </tr> </thead> <tbody> <tr> <td>X7R</td> <td>Within ±10%</td> </tr> <tr> <td>SL</td> <td>Within ±2.5% or ±0.25pF (Whichever is larger)</td> </tr> </tbody> </table>		Char.	Capacitance Change	X7R	Within ±10%	SL	Within ±2.5% or ±0.25pF (Whichever is larger)																		
	Char.	Capacitance Change																									
	X7R	Within ±10%																									
SL	Within ±2.5% or ±0.25pF (Whichever is larger)																										
I.R.	More than 1,000MΩ																										
Dielectric Strength	In accordance with item No.4																										
			<p>*Preheating</p> <table border="1" data-bbox="933 1456 1452 1534"> <thead> <tr> <th>Step</th> <th>Temperature</th> <th>Time</th> </tr> </thead> <tbody> <tr> <td>1</td> <td>100 to 120°C</td> <td>1 min.</td> </tr> <tr> <td>2</td> <td>170 to 200°C</td> <td>1 min.</td> </tr> </tbody> </table>	Step	Temperature	Time	1	100 to 120°C	1 min.	2	170 to 200°C	1 min.															
Step	Temperature	Time																									
1	100 to 120°C	1 min.																									
2	170 to 200°C	1 min.																									

*1 "Room condition" Temperature: 15 to 35°C, Relative humidity: 45 to 75%, Atmospheric pressure: 86 to 106kPa

*2 "C" expresses nominal capacitance value (pF).

Continued on the following page. 

GA3 Series Specifications and Test Methods

Continued from the preceding page.

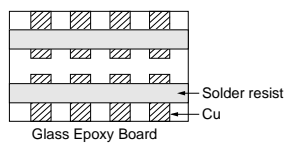
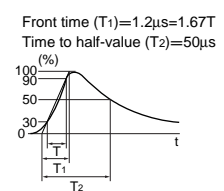
No.	Item	Specifications	Test Method															
16	Temperature Cycle	Appearance	No marking defects															
		Capacitance Change	<table border="1" style="width: 100%; border-collapse: collapse;"> <thead> <tr> <th style="width: 20%;">Char.</th> <th>Capacitance Change</th> </tr> </thead> <tbody> <tr> <td>X7R</td> <td>Within $\pm 15\%$</td> </tr> <tr> <td>SL</td> <td>Within $\pm 2.5\%$ or $\pm 0.25\text{pF}$ (Whichever is larger)</td> </tr> </tbody> </table>	Char.	Capacitance Change	X7R	Within $\pm 15\%$	SL	Within $\pm 2.5\%$ or $\pm 0.25\text{pF}$ (Whichever is larger)									
			Char.	Capacitance Change														
		X7R	Within $\pm 15\%$															
		SL	Within $\pm 2.5\%$ or $\pm 0.25\text{pF}$ (Whichever is larger)															
D.F. Q	<table border="1" style="width: 100%; border-collapse: collapse;"> <thead> <tr> <th style="width: 20%;">Char.</th> <th>Specification</th> </tr> </thead> <tbody> <tr> <td>X7R</td> <td>D.F. ≤ 0.05</td> </tr> <tr> <td>SL</td> <td>$Q \geq 400 + 20C^{*2}$ (C < 30pF) $Q \geq 1000$ (C $\geq 30\text{pF}$)</td> </tr> </tbody> </table>	Char.	Specification	X7R	D.F. ≤ 0.05	SL	$Q \geq 400 + 20C^{*2}$ (C < 30pF) $Q \geq 1000$ (C $\geq 30\text{pF}$)											
	Char.	Specification																
X7R	D.F. ≤ 0.05																	
SL	$Q \geq 400 + 20C^{*2}$ (C < 30pF) $Q \geq 1000$ (C $\geq 30\text{pF}$)																	
I.R.	More than 3,000M Ω																	
Dielectric Strength	In accordance with item No.4																	
			<p>Fix the capacitor to the supporting jig (glass epoxy board) shown in Fig. 4. Perform the 5 cycles according to the 4 heat treatments listed in the following table. Let sit for 24± 2 hrs. at room condition*1, then measure.</p> <table border="1" style="width: 100%; border-collapse: collapse; margin-bottom: 10px;"> <thead> <tr> <th style="width: 15%;">Step</th> <th style="width: 55%;">Temperature (°C)</th> <th style="width: 30%;">Time (min.)</th> </tr> </thead> <tbody> <tr> <td>1</td> <td>Min. Operating Temp. ± 3</td> <td>30± 3</td> </tr> <tr> <td>2</td> <td>Room Temp.</td> <td>2 to 3</td> </tr> <tr> <td>3</td> <td>Max. Operating Temp. ± 2</td> <td>30± 3</td> </tr> <tr> <td>4</td> <td>Room Temp.</td> <td>2 to 3</td> </tr> </tbody> </table> <p>•Pretreatment for X7R char. Perform a heat treatment at 150$\pm 1,8$°C for 60± 5 min. and then let sit for 24± 2 hrs. at room condition*1.</p> <div style="text-align: center;">  <p style="font-size: small;">Solder resist Cu Glass Epoxy Board</p> </div> <p style="text-align: center;">Fig. 4</p>	Step	Temperature (°C)	Time (min.)	1	Min. Operating Temp. ± 3	30 ± 3	2	Room Temp.	2 to 3	3	Max. Operating Temp. ± 2	30 ± 3	4	Room Temp.	2 to 3
Step	Temperature (°C)	Time (min.)																
1	Min. Operating Temp. ± 3	30 ± 3																
2	Room Temp.	2 to 3																
3	Max. Operating Temp. ± 2	30 ± 3																
4	Room Temp.	2 to 3																
17	Humidity (Steady State)	Appearance	No marking defects															
		Capacitance Change	<table border="1" style="width: 100%; border-collapse: collapse;"> <thead> <tr> <th style="width: 20%;">Char.</th> <th>Capacitance Change</th> </tr> </thead> <tbody> <tr> <td>X7R</td> <td>Within $\pm 15\%$</td> </tr> <tr> <td>SL</td> <td>Within $\pm 5.0\%$ or $\pm 0.5\text{pF}$ (Whichever is larger)</td> </tr> </tbody> </table>	Char.	Capacitance Change	X7R	Within $\pm 15\%$	SL	Within $\pm 5.0\%$ or $\pm 0.5\text{pF}$ (Whichever is larger)									
			Char.	Capacitance Change														
		X7R	Within $\pm 15\%$															
		SL	Within $\pm 5.0\%$ or $\pm 0.5\text{pF}$ (Whichever is larger)															
D.F. Q	<table border="1" style="width: 100%; border-collapse: collapse;"> <thead> <tr> <th style="width: 20%;">Char.</th> <th>Specification</th> </tr> </thead> <tbody> <tr> <td>X7R</td> <td>D.F. ≤ 0.05</td> </tr> <tr> <td>SL</td> <td>$Q \geq 275 + 5/2C^{*2}$ (C < 30pF) $Q \geq 350$ (C $\geq 30\text{pF}$)</td> </tr> </tbody> </table>	Char.	Specification	X7R	D.F. ≤ 0.05	SL	$Q \geq 275 + 5/2C^{*2}$ (C < 30pF) $Q \geq 350$ (C $\geq 30\text{pF}$)											
	Char.	Specification																
X7R	D.F. ≤ 0.05																	
SL	$Q \geq 275 + 5/2C^{*2}$ (C < 30pF) $Q \geq 350$ (C $\geq 30\text{pF}$)																	
I.R.	More than 3,000M Ω																	
Dielectric Strength	In accordance with item No.4																	
			<p>Before this test, the test shown in the following is performed. -Item 11 Adhesive Strength of Termination (applied force is 5N) -Item 13 Deflection</p> <p>Let the capacitor sit at 40± 2°C and relative humidity of 90 to 95% for 500± 24 hrs. Remove and let sit for 24± 2 hrs. at room condition*1, then measure.</p> <p>•Pretreatment for X7R char. Perform a heat treatment at 150$\pm 1,8$°C for 60± 5 min. and then let sit for 24± 2 hrs. at room condition*1.</p>															
18	Life	Appearance	No marking defects															
		Capacitance Change	<table border="1" style="width: 100%; border-collapse: collapse;"> <thead> <tr> <th style="width: 20%;">Char.</th> <th>Capacitance Change</th> </tr> </thead> <tbody> <tr> <td>X7R</td> <td>Within $\pm 20\%$</td> </tr> <tr> <td>SL</td> <td>Within $\pm 3.0\%$ or $\pm 0.3\text{pF}$ (Whichever is larger)</td> </tr> </tbody> </table>	Char.	Capacitance Change	X7R	Within $\pm 20\%$	SL	Within $\pm 3.0\%$ or $\pm 0.3\text{pF}$ (Whichever is larger)									
			Char.	Capacitance Change														
		X7R	Within $\pm 20\%$															
		SL	Within $\pm 3.0\%$ or $\pm 0.3\text{pF}$ (Whichever is larger)															
D.F. Q	<table border="1" style="width: 100%; border-collapse: collapse;"> <thead> <tr> <th style="width: 20%;">Char.</th> <th>Specification</th> </tr> </thead> <tbody> <tr> <td>X7R</td> <td>D.F. ≤ 0.05</td> </tr> <tr> <td>SL</td> <td>$Q \geq 275 + 5/2C^{*2}$ (C < 30pF) $Q \geq 350$ (C $\geq 30\text{pF}$)</td> </tr> </tbody> </table>	Char.	Specification	X7R	D.F. ≤ 0.05	SL	$Q \geq 275 + 5/2C^{*2}$ (C < 30pF) $Q \geq 350$ (C $\geq 30\text{pF}$)											
	Char.	Specification																
X7R	D.F. ≤ 0.05																	
SL	$Q \geq 275 + 5/2C^{*2}$ (C < 30pF) $Q \geq 350$ (C $\geq 30\text{pF}$)																	
I.R.	More than 3,000M Ω																	
Dielectric Strength	In accordance with item No.4																	
			<p>Before this test, the test shown in the following is performed. -Item 11 Adhesive Strength of Termination (apply force is 5N) -Item 13 Deflection</p> <p>Impulse Voltage Each individual capacitor should be subjected to a 2.5kV (Type GC/GF: 5kV) Impulse (the voltage value means zero to peak) for three times. Then the capacitors are applied to life test.</p> <div style="text-align: right;">  <p style="font-size: x-small;">Front time (T1)=1.2μs=1.67T Time to half-value (T2)=50μs</p> </div> <p>Apply voltage as Table for 1,000 hrs. at 125$\pm 2,8$°C, relative humidity 50% max.</p> <table border="1" style="width: 100%; border-collapse: collapse; margin-bottom: 10px;"> <thead> <tr> <th style="width: 15%;">Type</th> <th>Applied Voltage</th> </tr> </thead> <tbody> <tr> <td>GB</td> <td>AC312.5V (r.m.s.), except that once each hour the voltage is increased to AC1,000V (r.m.s.) for 0.1 sec.</td> </tr> <tr> <td>GD</td> <td rowspan="2">AC425V (r.m.s.), except that once each hour the voltage is increased to AC1,000V (r.m.s.) for 0.1 sec.</td> </tr> <tr> <td>GF</td> </tr> </tbody> </table> <p>Let sit for 24± 2 hrs. at room condition*1, then measure. •Pretreatment for X7R char. Perform a heat treatment at 150$\pm 1,8$°C for 60± 5 min. and then let sit for 24± 2 hrs. at room condition*1.</p>	Type	Applied Voltage	GB	AC312.5V (r.m.s.), except that once each hour the voltage is increased to AC1,000V (r.m.s.) for 0.1 sec.	GD	AC425V (r.m.s.), except that once each hour the voltage is increased to AC1,000V (r.m.s.) for 0.1 sec.	GF								
Type	Applied Voltage																	
GB	AC312.5V (r.m.s.), except that once each hour the voltage is increased to AC1,000V (r.m.s.) for 0.1 sec.																	
GD	AC425V (r.m.s.), except that once each hour the voltage is increased to AC1,000V (r.m.s.) for 0.1 sec.																	
GF																		

*1 "Room condition" Temperature: 15 to 35°C, Relative humidity: 45 to 75%, Atmospheric pressure: 86 to 106kPa

*2 "C" expresses nominal capacitance value (pF).

Continued on the following page.

GA3 Series Specifications and Test Methods

Continued from the preceding page.

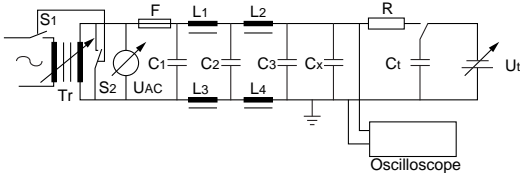
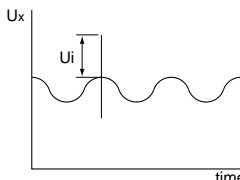
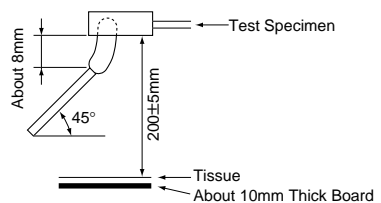
No.	Item	Specifications	Test Method																		
19	Appearance	No marking defects	Before this test, the test shown in the following is performed. -Item 11 Adhesive Strength of Termination (apply force is 5N) -Item 13 Deflection Apply the rated voltage at $40\pm 2^{\circ}\text{C}$ and relative humidity of 90 to 95% for $500\pm 2^{\circ}\text{hrs}$. Remove and let sit for 24 ± 2 hrs. at room condition*, then measure. •Pretreatment for X7R char. Perform a heat treatment at $150\pm 1,8^{\circ}\text{C}$ for 60 ± 5 min. and then let sit for 24 ± 2 hrs. at room condition*.																		
	Capacitance Change	Char.		Capacitance Change																	
		X7R		Within $\pm 15\%$																	
	D.F. Q	SL		Within $\pm 5.0\%$ or $\pm 0.5\text{pF}$ (Whichever is larger)																	
		Char.		Specification																	
X7R	D.F. ≤ 0.05																				
SL	$Q \geq 275 + 5/2C^{*2}$ (C < 30pF) $Q \geq 350$ (C $\geq 30\text{pF}$)																				
I.R.	More than 3,000M Ω																				
Dielectric Strength	In accordance with item No.4																				
20	Active Flammability	The cheesecloth should not be on fire.	The capacitor should be individually wrapped in at least one but not more than two complete layers of cheesecloth. The capacitor should be subjected to 20 discharges. The interval between successive discharges should be 5 sec. The UAC should be maintained for 2 min. after the last discharge.  <table border="0"> <tr> <td>C1,2 : $1\mu\text{F}\pm 10\%$</td> <td>C3 : $0.033\mu\text{F}\pm 5\%$ 10kV</td> </tr> <tr> <td>L1 to 4 : 1.5mH$\pm 20\%$ 16A Rod core choke</td> <td></td> </tr> <tr> <td>Ct : $3\mu\text{F}\pm 5\%$ 10kV</td> <td>R : $100\Omega\pm 2\%$</td> </tr> <tr> <td>Cx : Capacitor under test</td> <td>UAC : $U_R\pm 5\%$</td> </tr> <tr> <td>F : Fuse, Rated 16A</td> <td>UR : Rated Voltage</td> </tr> <tr> <td></td> <td>Ut : Voltage applied to Ct</td> </tr> </table>  <table border="1"> <thead> <tr> <th>Type</th> <th>Ui</th> </tr> </thead> <tbody> <tr> <td>GB, GD</td> <td>2.5kV</td> </tr> <tr> <td>GC, GF</td> <td>5kV</td> </tr> </tbody> </table>	C1,2 : $1\mu\text{F}\pm 10\%$	C3 : $0.033\mu\text{F}\pm 5\%$ 10kV	L1 to 4 : 1.5mH $\pm 20\%$ 16A Rod core choke		Ct : $3\mu\text{F}\pm 5\%$ 10kV	R : $100\Omega\pm 2\%$	Cx : Capacitor under test	UAC : $U_R\pm 5\%$	F : Fuse, Rated 16A	UR : Rated Voltage		Ut : Voltage applied to Ct	Type	Ui	GB, GD	2.5kV	GC, GF	5kV
				C1,2 : $1\mu\text{F}\pm 10\%$	C3 : $0.033\mu\text{F}\pm 5\%$ 10kV																
L1 to 4 : 1.5mH $\pm 20\%$ 16A Rod core choke																					
Ct : $3\mu\text{F}\pm 5\%$ 10kV	R : $100\Omega\pm 2\%$																				
Cx : Capacitor under test	UAC : $U_R\pm 5\%$																				
F : Fuse, Rated 16A	UR : Rated Voltage																				
	Ut : Voltage applied to Ct																				
Type	Ui																				
GB, GD	2.5kV																				
GC, GF	5kV																				
21	Passive Flammability	The burning time should not exceed 30 sec. The tissue paper should not ignite.	The capacitor under test should be held in the flame in the position which best promotes burning. Each specimen should only be exposed once to the flame. Time of exposure to flame: 30 sec. Length of flame : $12\pm 1\text{mm}$ Gas burner : Length 35mm min. : Inside Dia. $0.5\pm 0.1\text{mm}$: Outside Dia. 0.9mm max. Gas : Butane gas Purity 95% min. 																		

*1 "Room condition" Temperature: 15 to 35 $^{\circ}\text{C}$, Relative humidity: 45 to 75%, Atmospheric pressure: 86 to 106kPa

*2 "C" expresses nominal capacitance value (pF).

GRM/GR4/GR7/GA2/GA3 Series Data (Typical Example)

■ Capacitance - Temperature Characteristics

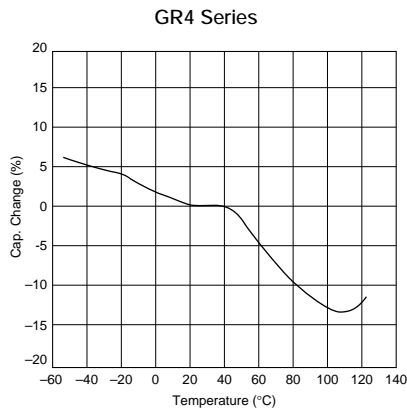
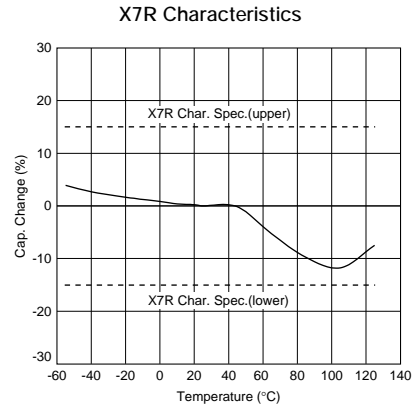
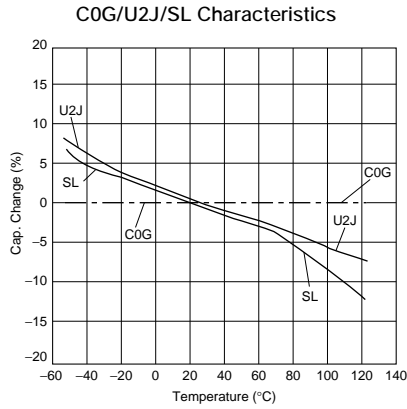

■ Impedance - Frequency Characteristics

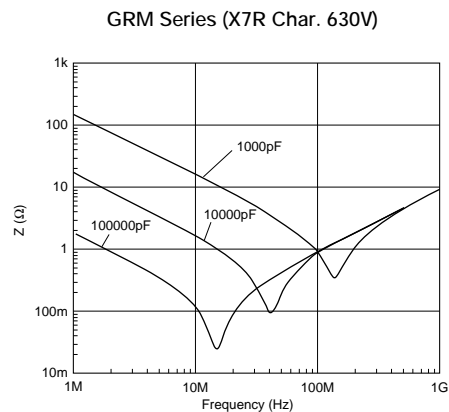
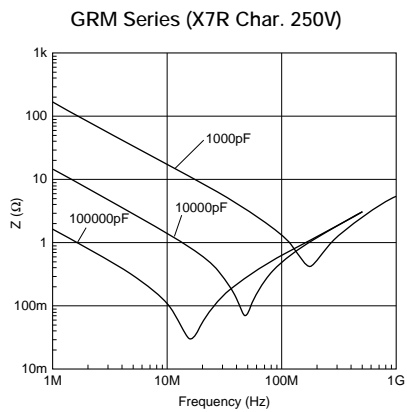

Continued on the following page.

GRM/GR4/GR7/GA2/GA3 Series Data (Typical Example)

Continued from the preceding page.

■ Impedance - Frequency Characteristics

GR4 Series

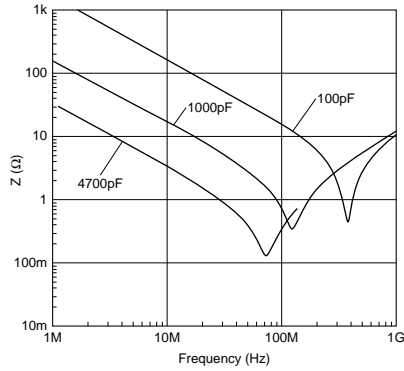

GR7 Series

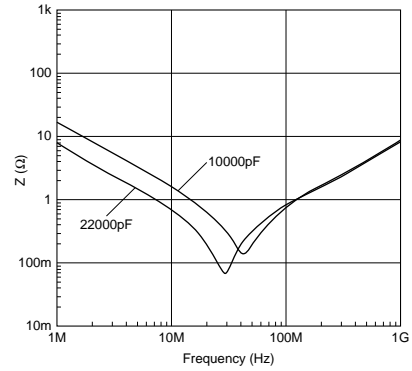

GA2 Series

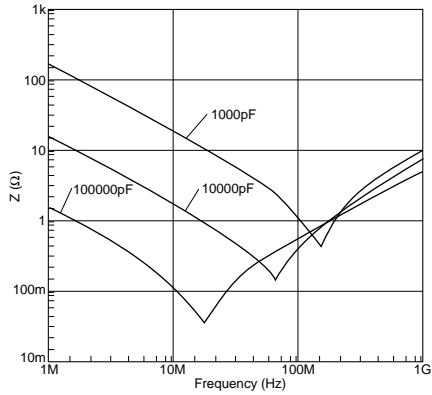

GA3 Series (Type GD)

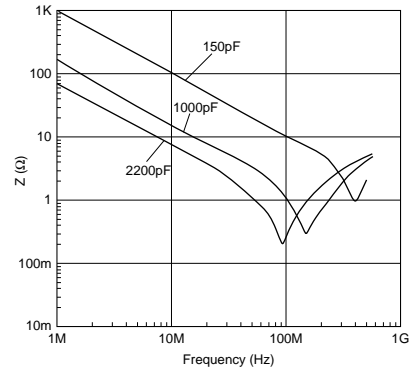

GA3 Series (Type GF)

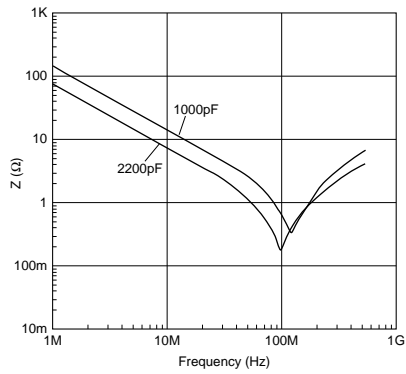

GA3 Series (Type GB)

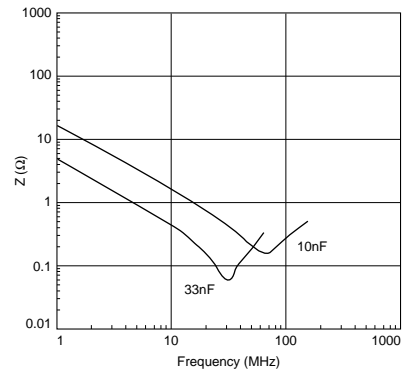

GRM/GR4/GR7/GA2/GA3 Series Data (Typical Example)

■ Capacitance - AC Voltage Characteristics

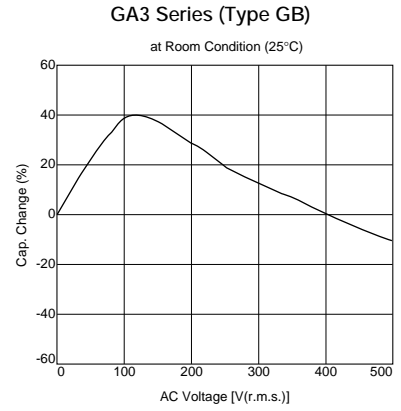
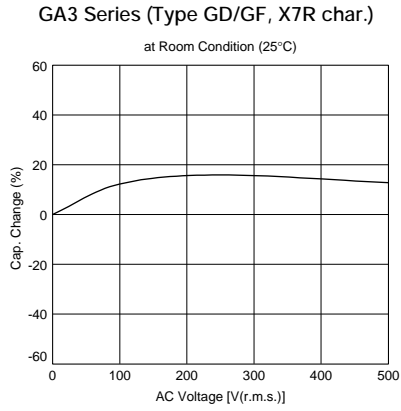

Package

Taping is standard packaging method.

■ Minimum Quantity Guide

Part Number		Dimensions (mm)			Quantity (pcs.)	
		L	W	T	ø180mm Reel	
Paper Tape	Embossed Tape					
Medium-voltage	GRM18	1.6	0.8	0.8	4,000	-
	GRM21	2.0	1.25	1.0	4,000	-
				1.25	-	3,000
	GRM31/GR731	3.2	1.6	1.0	4,000	-
				1.25	-	3,000
				1.6	-	2,000
	GRM32	3.2	2.5	1.0	4,000	-
				1.25	-	3,000
				1.5	-	2,000
	GRM42/GR442	4.5	2.0	2.0	-	1,000
				1.0	-	3,000
				1.5	-	2,000
GRM43/GR443	4.5	3.2	2.0	-	2,000	
			1.5	-	1,000	
			2.5	-	500	
GRM55/GR455	5.7	5.0	2.0	-	1,000	
AC250V	GA242	4.5	2.0	1.5	-	2,000
	GA243	4.5	3.2	1.5	-	1,000
				2.0	-	1,000
GA255	5.7	5.0	2.0	-	1,000	
Safety Std. Recognition	GA342	4.5	2.0	1.0	-	3,000
				1.5	-	2,000
				2.0	-	2,000
	GA343	4.5	3.2	1.5	-	1,000
				2.0	-	1,000
	GA352	5.7	2.8	1.5	-	1,000
	GA355	5.7	5.0	1.5	-	1,000
2.0				-	1,000	
			2.7	-	500	

■ Tape Carrier Packaging

(1) Appearance of Taping

① Embossed Tape

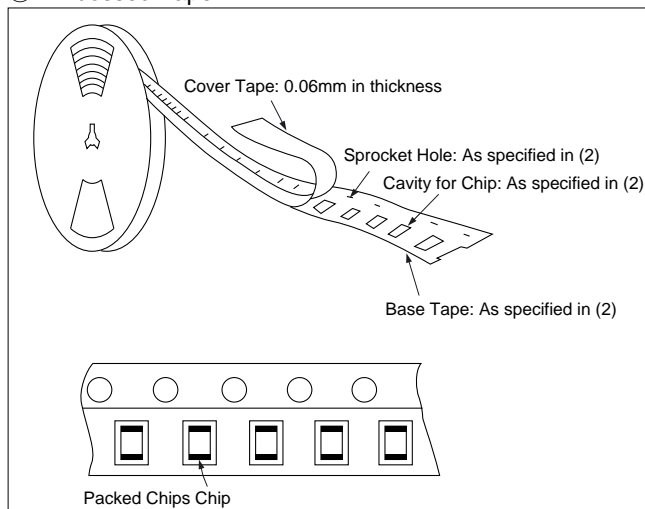

② Paper Tape

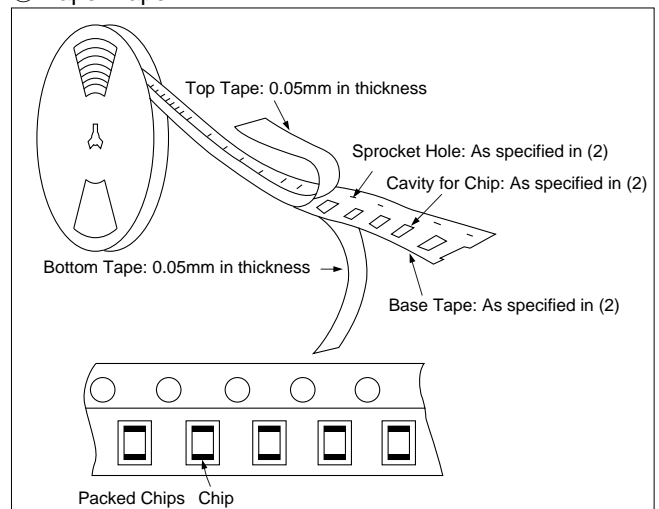

Continued on the following page.

Package

Continued from the preceding page.

(2) Dimensions of Tape

① Embossed Tape

8mm width 4mm pitch Tape

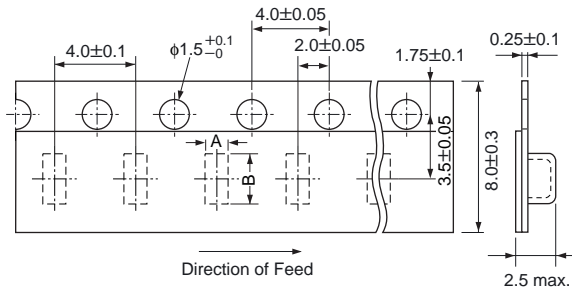

Part Number	A*	B*
GRM21 (T≥1.25mm)	1.45	2.25
GRM31/GR731 (T≥1.25mm)	2.0	3.6
GRM32 (T≥1.25mm)	2.9	3.6

*Nominal Value

12mm width 8mm/4mm pitch Tape

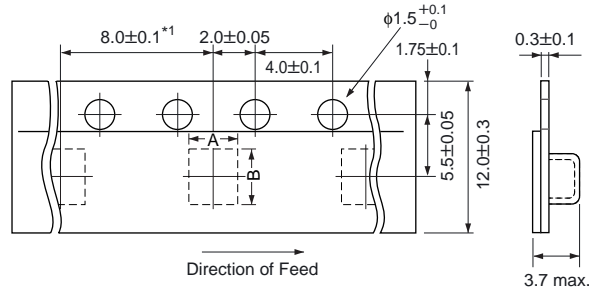

Part Number	A*	B*
GRM42/GR442/GA242/GA342	2.5	5.1
GRM43/GR443/GA243/GA343	3.6	4.9
GA352	3.2	6.1
GRM55/GR455/GA255/GA355	5.4	6.1

*1 4.0±0.1mm in case of GRM42/GR442/GA242/GA342

*Nominal Value

(in mm)

② Paper Tape

8mm width 4mm pitch Tape

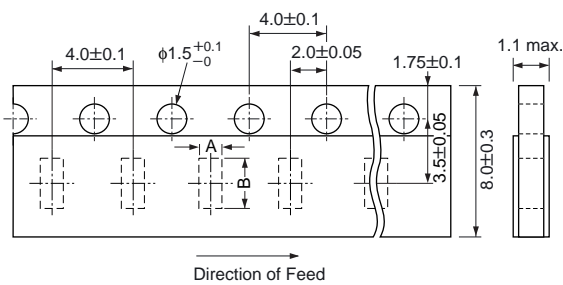

Part Number	A*	B*
GRM18	1.05	1.85
GRM21 (T=1.0mm)	1.45	2.25
GRM31/GR731 (T=1.0mm)	2.0	3.6
GRM32 (T=1.0mm)	2.9	3.6

*Nominal value
(in mm)

(3) Dimensions of Reel

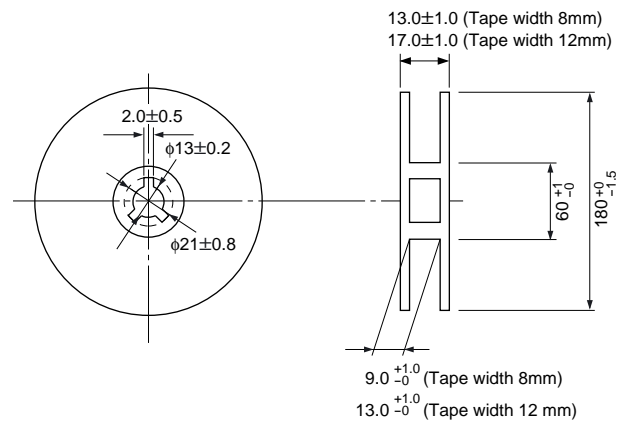

(in mm)

Continued on the following page. ↗

Package

☐ Continued from the preceding page.

(4) Taping Method

- ① Tapes for capacitors are wound clockwise. The sprocket holes are to the right as the tape is pulled toward the user.
- ② Part of the leader and part of the empty tape should be attached to the end of the tape as shown at right.
- ③ The top tape or cover tape and base tape are not attached at the end of the tape for a minimum of 5 pitches.
- ④ Missing capacitors number within 0.1% of the number per reel or 1 pc, whichever is greater, and are not continuous.
- ⑤ The top tape or cover tape and bottom tape should not protrude beyond the edges of the tape and should not cover sprocket holes.
- ⑥ Cumulative tolerance of sprocket holes, 10 pitches: $\pm 0.3\text{mm}$.
- ⑦ Peeling off force: 0.1 to 0.6N in the direction shown at right.

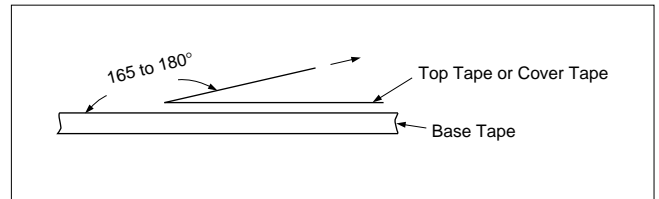
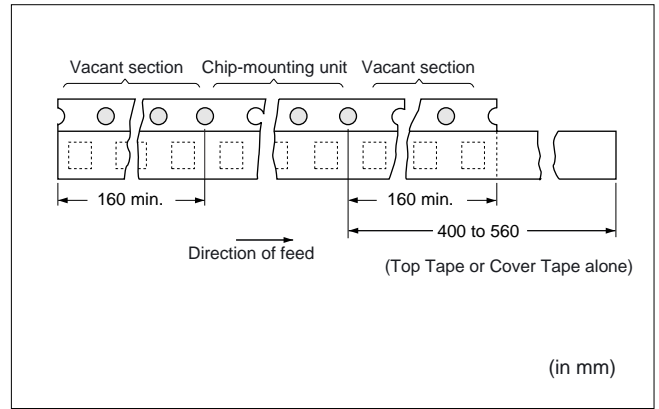



■ Storage and Operating Conditions

Operating and storage environment

Do not use or store capacitors in a corrosive atmosphere, especially where chloride gas, sulfide gas, acid, alkali, salt or the like are present. And avoid exposure to moisture. Before cleaning, bonding or molding this product, verify that these processes do not affect product quality by testing the performance of a cleaned, bonded or molded product in the intended equipment. Store the capacitors

where the temperature and relative humidity do not exceed 5 to 40 degrees centigrade and 20 to 70%. Use capacitors within 6 months after delivered. Check the solderability after 6 months or more.

FAILURE TO FOLLOW THE ABOVE CAUTIONS MAY RESULT, WORST CASE, IN A SHORT CIRCUIT AND CAUSE FUMING OR PARTIAL DISPERSION WHEN THE PRODUCT IS USED.

■ Handling

1. Vibration and impact

Do not expose a capacitor to excessive shock or vibration during use.

2. Do not directly touch the chip capacitor, especially the ceramic body. Residue from hands/fingers may create a short circuit environment.

FAILURE TO FOLLOW THE ABOVE CAUTIONS MAY RESULT, WORST CASE, IN A SHORT CIRCUIT AND CAUSE FUMING OR PARTIAL DISPERSION WHEN THE PRODUCT IS USED.

⚠ Caution

■ Caution (Rating)

1. Operating Voltage

When DC-rated capacitors are to be used in AC or ripple current circuits, be sure to maintain the V_{p-p} value of the applied voltage or the V_{o-p} which contains DC bias within the rated voltage range.

When the voltage is applied to the circuit, starting or stopping may generate irregular voltage for a transit period because of resonance or switching. Be sure to use a capacitor with a rated voltage range that includes these irregular voltages.

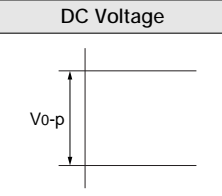
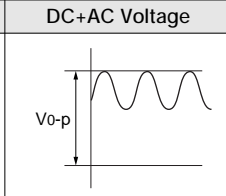
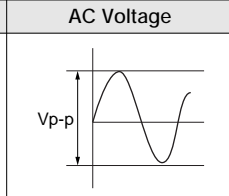
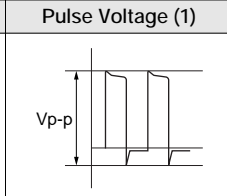
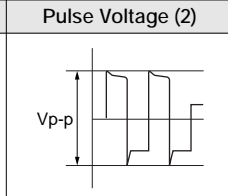
Voltage	DC Voltage	DC+AC Voltage	AC Voltage	Pulse Voltage (1)	Pulse Voltage (2)
Positional Measurement					

2. Operating Temperature, Self-generated Heat, and Lead Reduction at High-frequency voltage condition

Keep the surface temperature of a capacitor below the upper limit of its rated operating temperature range.

Be sure to take into account the heat generated by the capacitor itself. When the capacitor is used in a high-frequency voltage, pulse voltage, it may self-generate heat due to dielectric loss.

(1) In case of X7R char.

Applied voltage should be the load such as self-generated heat is within 20°C on the condition of atmosphere temperature 25°C . When measuring, use a thermocouple of small thermal capacity -K of $\phi 0.1\text{mm}$ in conditions where the capacitor is not affected by radiant heat from other components or surrounding ambient fluctuations. Excessive heat may lead to deterioration of the capacitor's characteristics and reliability. (Never attempt to perform measurement with the cooling fan running. Otherwise, accurate measurement cannot be ensured.)

Continued on the following page. 



Continued from the preceding page.

(2) In case of C0G, U2J char.

Due to the low self-heating characteristics of low-dissipation capacitors, the allowable electric power of these capacitors is generally much higher than that of X7R characteristic capacitors.

When a high frequency voltage which cause 20°C self heating to the capacitor is applied, it will exceed capacitor's allowable electric power.

<C0G char.>

Therefore, in case of C0G char., the frequency of the applied sine wave voltage should be less than 100kHz. The applied voltage should be less than the value shown in figure at right. The capacitors less than 22pF can be applied maximum 4.0kV peak to peak at 100kHz or less only for the ballast or the resonance usage in the LCD backlight inverter circuit.

<U2J char.>

In case of U2J char., the frequency of the applied sine wave voltage should be less than 500kHz (less than 100kHz in case of rated voltage: DC3.15kV). The applied voltage should be less than the value shown in figure below.

<Capacitor selection tool>

We are also offering free software the "capacitor selection tool: Murata Medium Voltage Capacitors Selection Tool by Voltage Form (*)" which will assist you in selecting a suitable capacitor.

The temperature of the surface of capacitor: 125°C or less (including self-heating)

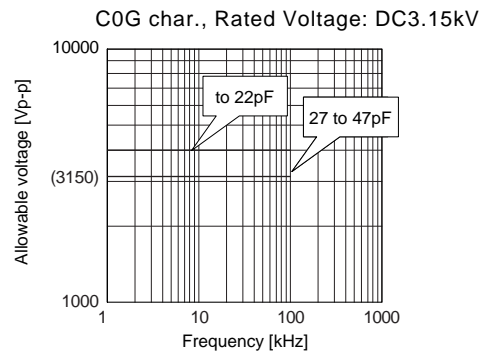

The sine-wave frequency VS allowable voltage

The software can be downloaded from Murata's Internet Website (http://www.murata.com/designlib/mmcsv_e.html). By inputting capacitance values and applied voltage waveform of the specific capacitor series, this software will calculate the capacitor's power consumption and list suitable capacitors (non-sine wave is also available).

* As of Jul. 2006, subject series are below.
 - Temperature Characteristics C0G, U2J

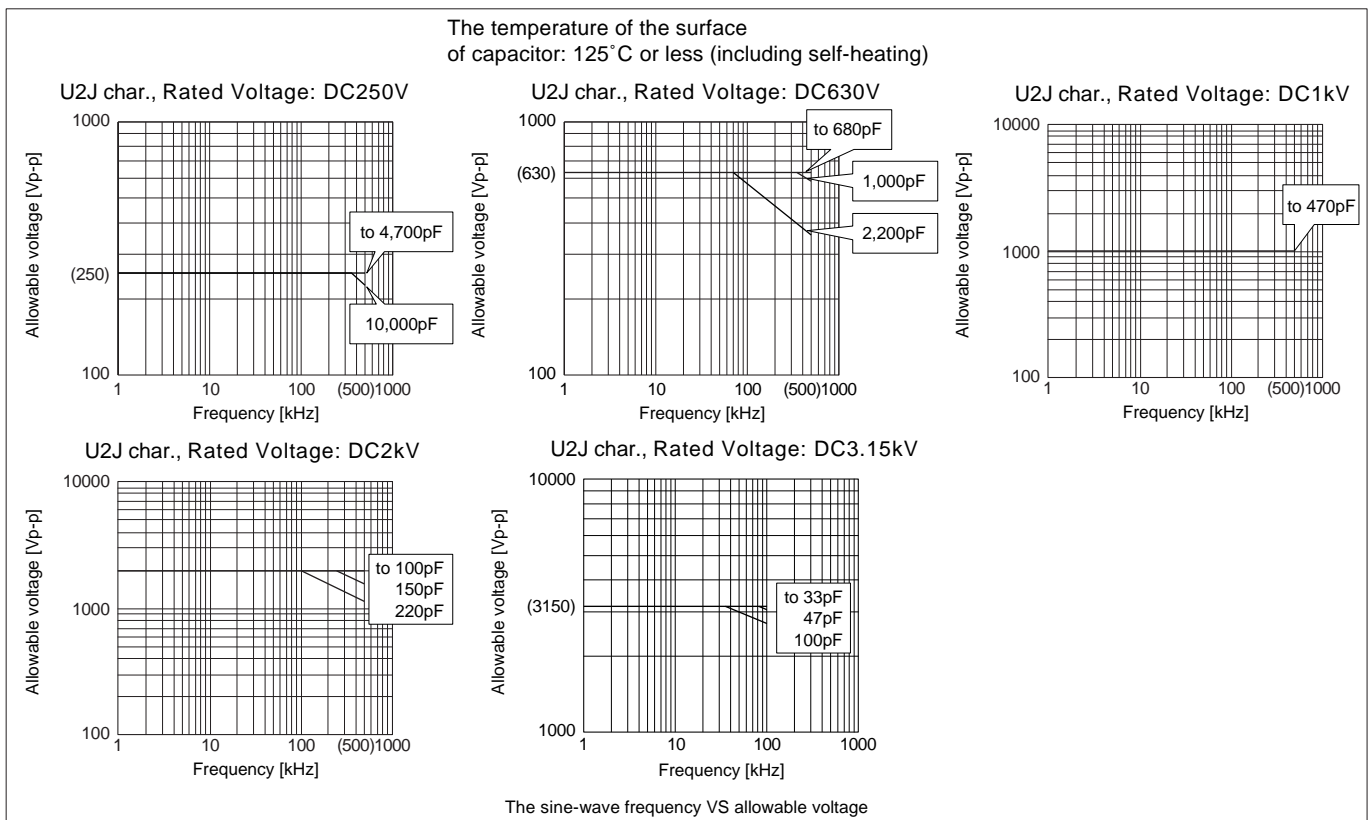

The sine-wave frequency VS allowable voltage

Continued on the following page. ↗

⚠ Caution

☐ Continued from the preceding page.

3. Fail-safe

Failure of a capacitor may result in a short circuit. Be sure to provide an appropriate fail-safe function such as a fuse on your product to help eliminate possible electric shock, fire, or fumes.

Please consider using fuses on each AC line if the capacitors are used between the AC input lines and earth (line bypass capacitors), to prepare for the worst case, such as a short circuit.

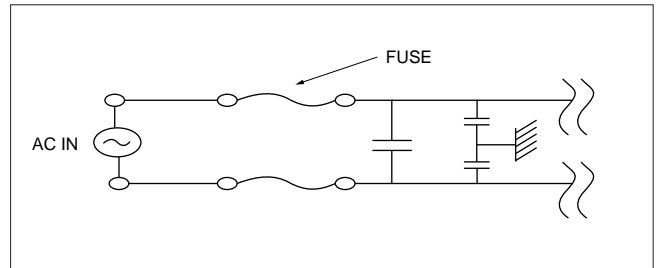

4. Test condition for AC withstanding Voltage

(1) Test Equipment

Tests for AC withstanding voltage should be made with equipment capable of creating a wave similar to a 50/60 Hz sine wave.

If the distorted sine wave or overload exceeding the specified voltage value is applied, a defect may be caused.

(2) Voltage applied method

The capacitor's leads or terminals should be firmly connected to the output of the withstanding voltage test equipment, and then the voltage should be raised from near zero to the test voltage. If the test voltage is applied directly to the capacitor without raising it from near zero, it should be applied with the zero cross*. At the end of the test time, the test voltage should be reduced to near zero, and then the capacitor's leads or terminals should be taken off the output of the withstanding voltage test equipment. If the test voltage is applied directly to the capacitor without raising it from near zero, surge voltage may occur and cause a defect.

*ZERO CROSS is the point where voltage sine wave pass 0V.

- See the figure at right -

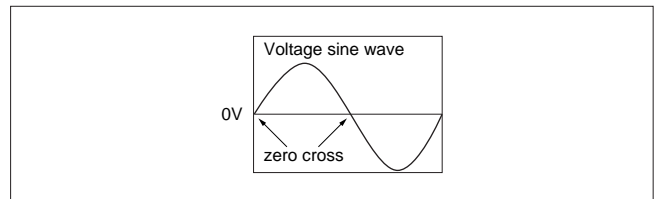

FAILURE TO FOLLOW THE ABOVE CAUTIONS MAY RESULT, WORST CASE, IN A SHORT CIRCUIT AND CAUSE FUMING OR PARTIAL DISPERSION WHEN THE PRODUCT IS USED.

Caution

Caution (Soldering and Mounting)

1. Vibration and Impact

Do not expose a capacitor to excessive shock or vibration during use.

2. Circuit Board Material

In case that ceramic chip capacitor is soldered on the metal board, such as Aluminum board, the stress of heat expansion and contraction might cause the crack of ceramic capacitor, due to the difference of thermal expansion coefficient between metal board and ceramic chip.

3. Land Layout for Cropping PC Board

Choose a mounting position that minimizes the stress imposed on the chip during flexing or bending of the board.

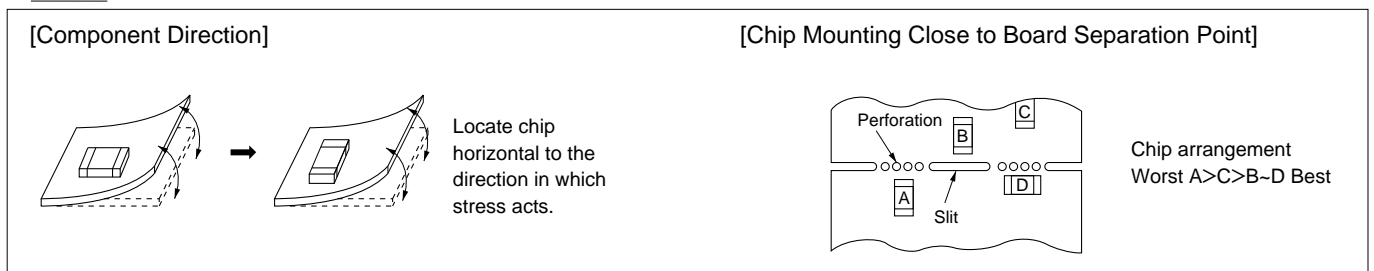

Continued on the following page.

Caution

Continued from the preceding page.

4. Reflow Soldering

- When sudden heat is given to the components, the mechanical strength of the components should go down because remarkable temperature change causes deformity of components inside. In order to prevent mechanical damage in the components, preheating should be required for both of the components and the PCB board. Preheating conditions are shown in Table 1. It is required to keep temperature differential between the soldering and the components surface (ΔT) as small as possible.
- Solderability of Tin plating termination chip might be deteriorated when low temperature soldering profile where peak solder temperature is below the Tin melting point is used. Please confirm the solderability of Tin plating termination chip before use.
- When components are immersed in solvent after mounting, be sure to maintain the temperature difference (ΔT) between the component and solvent within the range shown in the Table 1.

Table 1

Part Number	Temperature Differential
G□□18/21/31	$\Delta T \leq 190^\circ\text{C}$
G□□32/42/43/52/55	$\Delta T \leq 130^\circ\text{C}$

Recommended Conditions

	Pb-Sn Solder		Lead Free Solder
	Infrared Reflow	Vapor Reflow	
Peak Temperature	230-250°C	230-240°C	240-260°C
Atmosphere	Air	Air	Air or N ₂

Pb-Sn Solder: Sn-37Pb

Lead Free Solder: Sn-3.0Ag-0.5Cu

Optimum Solder Amount for Reflow Soldering

- Overly thick application of solder paste results in excessive fillet height solder. This makes the chip more susceptible to mechanical and thermal stress on the board and may cause cracked chips.
- Too little solder paste results in a lack of adhesive strength on the outer electrode, which may result in chips breaking loose from the PCB.
- Make sure the solder has been applied smoothly to the end surface to a height of 0.2mm min.

Inverting the PCB

Make sure not to impose an abnormal mechanical shock on the PCB.

[Standard Conditions for Reflow Soldering]

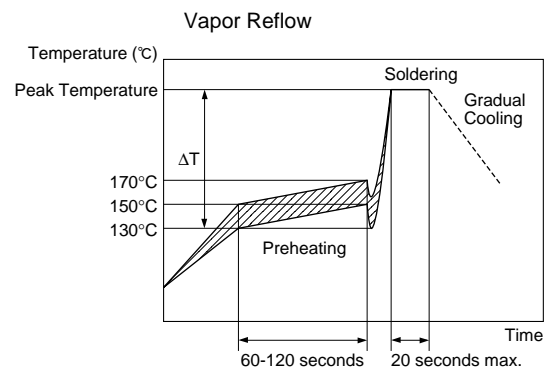
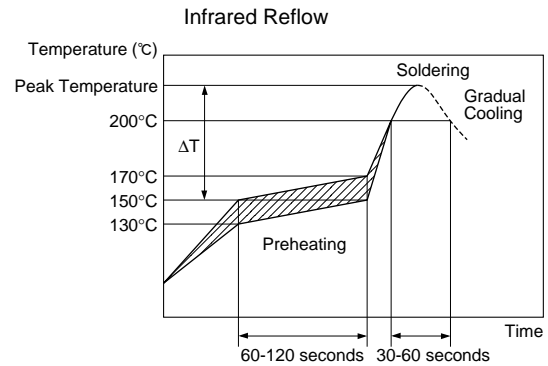

[Allowable Soldering Temperature and Time]

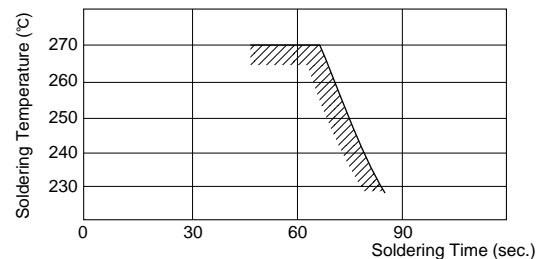

In case of repeated soldering, the accumulated soldering time must be within the range shown above.

[Optimum Solder Amount for Reflow Soldering]

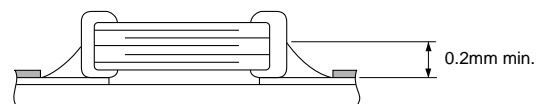



Continued from the preceding page.

5. Flow Soldering

- When sudden heat is given to the components, the mechanical strength of the components should go down because remarkable temperature change causes deformity of components inside. And an excessively long soldering time or high soldering temperature results in leaching by the outer electrodes, causing poor adhesion or a reduction in capacitance value due to loss of contact between electrodes and end termination.
- In order to prevent mechanical damage in the components, preheating should be required for both of the components and the PCB board. Preheating conditions are shown in Table 2. It is required to keep temperature differential between the soldering and the components surface (ΔT) as small as possible.
- When components are immersed in solvent after mounting, be sure to maintain the temperature difference between the component and solvent within the range shown in Table 2.
Do not apply flow soldering to chips not listed in Table 2.

Table 2

Part Number	Temperature Differential
G□□18/21/31	$\Delta T \leq 150^\circ\text{C}$

Recommended Conditions

	Pb-Sn Solder	Lead Free Solder
Peak Temperature	240-250°C	250-260°C
Atmosphere	Air	N ₂

Pb-Sn Solder: Sn-37Pb
 Lead Free Solder: Sn-3.0Ag-0.5Cu

- Optimum Solder Amount for Flow Soldering
 The top of the solder fillet should be lower than the thickness of components. If the solder amount is excessively big, the risk of cracking is higher during board bending or under any other stressful conditions.

[Standard Conditions for Flow Soldering]

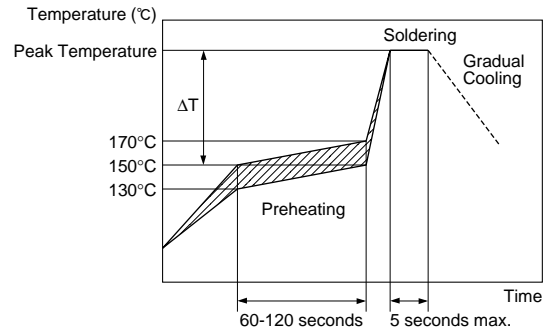

[Allowable Soldering Temperature and Time]

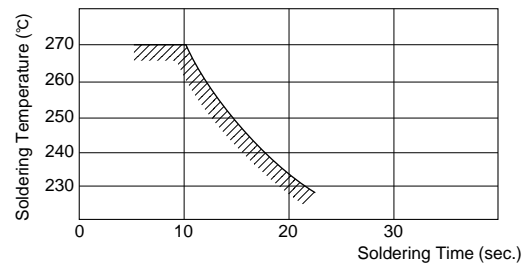

In case of repeated soldering, the accumulated soldering time must be within the range shown above.

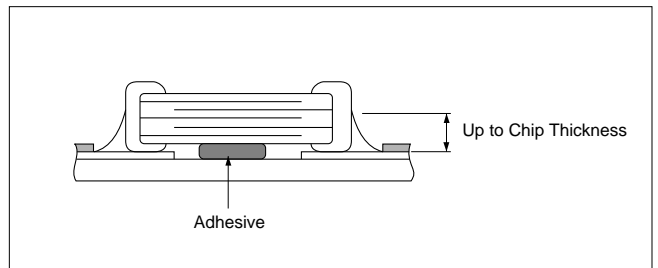

Continued on the following page. ↗

⚠ Caution

☐ Continued from the preceding page.

6. Correction with a Soldering Iron

(1) For Chip Type Capacitors

- When sudden heat is applied to the components by soldering iron, the mechanical strength of the components should go down because remarkable temperature change causes deformity of components inside. In order to prevent mechanical damage in the components, preheating should be required for both of the components and the PCB board. Preheating conditions are shown in Table 3. It is required to keep temperature differential between the soldering and the components surface (ΔT) as small as possible. After soldering, it should not be allowed to cool down rapidly.

Table 3

Part Number	Temperature Differential	Peak Temperature	Atmosphere
G□□18/21/31	$\Delta T \leq 190^\circ\text{C}$	300°C max. 3 sec. max. / termination (both sides total 6 sec. max.)	Air
G□□32/42/43/ 52/55	$\Delta T \leq 130^\circ\text{C}$	270°C max. 3 sec. max. / termination (both sides total 6 sec. max.)	Air

*Applicable for both Pb-Sn and Lead Free Solder.

Pb-Sn Solder: Sn-37Pb

Lead Free Solder: Sn-3.0Ag-0.5Cu

- Optimum Solder Amount when Corrections Are Made Using a Soldering Iron

The top of the solder fillet should be lower than the thickness of components. If the solder amount is excessively big, the risk of cracking is higher during board bending or under any other stressful conditions. Soldering iron $\phi 3\text{mm}$ or smaller should be required. And it is necessary to keep a distance between the soldering iron and the components without direct touch. Thread solder with $\phi 0.5\text{mm}$ or smaller is required for soldering.

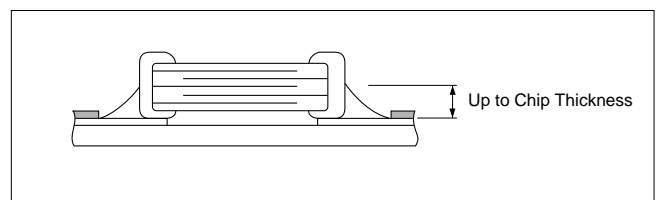

7. Washing

Excessive output of ultrasonic oscillation during cleaning causes PCBs to resonate, resulting in cracked chips or broken solder. Take note not to vibrate PCBs.

FAILURE TO FOLLOW THE ABOVE CAUTIONS MAY RESULT, WORST CASE, IN A SHORT CIRCUIT AND FUMING WHEN THE PRODUCT IS USED.

Notice

■ Notice (Soldering and Mounting)

1. Construction of Board Pattern

After installing chips, if solder is excessively applied to the circuit board, mechanical stress will cause destruction resistance characteristics to lower. To prevent this, be extremely careful in determining shape and dimension before designing the circuit board diagram.

Construction and Dimensions of Pattern (Example)

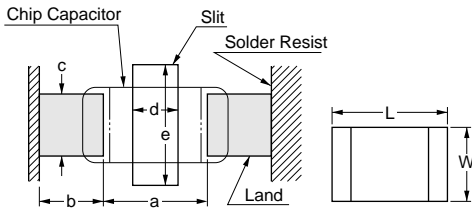

Preparing slit helps flux cleaning and resin coating on the back of the capacitor.

Flow Soldering

L×W	a	b	c
1.6×0.8	0.6-1.0	0.8-0.9	0.6-0.8
2.0×1.25	1.0-1.2	0.9-1.0	0.8-1.1
3.2×1.6	2.2-2.6	1.0-1.1	1.0-1.4

Flow soldering : 3.2×1.6 or less available.

Reflow Soldering

L×W	a	b	c	d	e
1.6×0.8	0.6-0.8	0.6-0.7	0.6-0.8	-	-
2.0×1.25	1.0-1.2	0.9-1.0	0.8-1.1	-	-
3.2×1.6	2.2-2.4	0.8-0.9	1.0-1.4	1.0-2.0	3.2-3.7
3.2×2.5	2.0-2.4	1.0-1.2	1.8-2.3	1.0-2.0	4.1-4.6
4.5×2.0	2.8-3.4	1.2-1.4	1.4-1.8	1.0-2.8	3.6-4.1
4.5×3.2	2.8-3.4	1.2-1.4	2.3-3.0	1.0-2.8	4.8-5.3
5.7×2.8	4.0-4.6	1.4-1.6	2.1-2.6	1.0-4.0	4.4-4.9
5.7×5.0	4.0-4.6	1.4-1.6	3.5-4.8	1.0-4.0	6.6-7.1

(in mm)

Land Layout to Prevent Excessive Solder

	Mounting Close to a Chassis	Mounting with Leaded Components	Mounting Leaded Components Later
Examples of Prohibition			
Examples of Improvements by the Land Division			

Continued on the following page. ↗

Notice

☐ Continued from the preceding page.

2. Mounting of Chips

● Thickness of adhesives applied

Keep thickness of adhesives applied (50-105 μ m or more) to reinforce the adhesive contact considering the thickness of the termination or capacitor (20-70 μ m) and the land pattern (30-35 μ m).

● Mechanical shock of the chip placer

When the positioning claws and pick-up nozzle are worn, the load is applied to the chip while positioning is concentrated in one position, thus causing cracks, breakage, faulty positioning accuracy, etc.

Careful checking and maintenance are necessary to prevent unexpected trouble.

An excessively low bottom dead point of the suction nozzle imposes great force on the chip during mounting, causing cracked chips. Please set the suction nozzle's bottom dead point on the upper surface of the board.

3. Soldering

(1) Limit of losing effective area of the terminations and conditions needed for soldering.

Depending on the conditions of the soldering temperature and/or immersion (melting time), effective areas may be lost in some part of the terminations.

To prevent this, be careful in soldering so that any possible loss of the effective area on the terminations will securely remain at a maximum of 25% on all edge length A-B-C-D-A of part with A, B, C, D, shown in the Figure below.

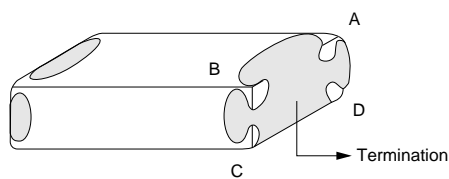

(2) Flux

● Please use it after confirming there is no problem in the reliability of the product beforehand with the intended equipment. The residue of flux might cause a decrease in nonconductivity and the corrosion of an external electrode, etc.

Continued on the following page. ☐

Notice

 Continued from the preceding page.

4. Cleaning

Please confirm there is no problem in the reliability of the product beforehand when cleaning it with the intended equipment.

The residue after cleaning it might cause the decrease in the surface resistance of the chip and the corrosion of the electrode part, etc. As a result it might cause reliability to deteriorate. Please confirm beforehand that there is no problem with the intended equipment in ultrasonic cleansing.

5. Resin Coating

Please use it after confirming there is no influence on the product with a intended equipment beforehand when the resin coating and molding.

A cracked chip might be caused at the cooling/heating cycle by the amount of resin spreading and/or bias thickness.

The resin for coating and molding must be selected as the stress is small when stiffening and the hygroscopic is low as possible.

■ Rating

1. Capacitance change of capacitor

(1) In case of X7R char.

Capacitors have an aging characteristic, whereby the capacitor continually decreases its capacitance slightly if the capacitor is left on for a long time. Moreover, capacitance might change greatly depending on the surrounding temperature or an applied voltage. So, it is not likely to be suitable for use in a time constant circuit.

Please contact us if you need detailed information.

(2) In case of any char. except X7R

Capacitance might change a little depending on the surrounding temperature or an applied voltage.

Please contact us if you intend to use this product in a strict time constant circuit.

2. Performance check by equipment

Before using a capacitor, check that there is no problem in the equipment's performance and the specifications.

Generally speaking, CLASS 2 (X7R char.) ceramic capacitors have voltage dependence characteristics and temperature dependence characteristics in capacitance. So, the capacitance value may change depending on the operating condition in the equipment.

Therefore, be sure to confirm the apparatus performance of receiving influence in a capacitance value change of a capacitor, such as leakage current and noise suppression characteristics.

Moreover, check the surge-proof ability of a capacitor in the equipment, if needed, because the surge voltage may exceed specific value by the inductance of the circuit.

ISO 9001 Certifications

■ Qualified Standards

The products listed here have been produced by ISO 9001 certified factory.

Plant
Fukui Murata Mfg. Co., Ltd.
Izumo Murata Mfg. Co., Ltd.
Okayama Murata Mfg. Co., Ltd.
Murata Electronics Singapore (Pte.) Ltd.
Murata Amazonia Industria E Comercio Ltda.
Suzhou Murata Electronics Co., Ltd.
Beijing Murata Electronics Co., Ltd.

△Note:

1. Export Control

〈For customers outside Japan〉

No muRata products should be used or sold, through any channels, for use in the design, development, production, utilization, maintenance or operation of, or otherwise contribution to (1) any weapons (Weapons of Mass Destruction (nuclear, chemical or biological weapons or missiles) or conventional weapons) or (2) goods or systems specially designed or intended for military end-use or utilization by military end-users.

〈For customers in Japan〉

For products which are controlled items subject to the "Foreign Exchange and Foreign Trade Law" of Japan, the export license specified by the law is required for export.

2. Please contact our sales representatives or product engineers before using the products in this catalog for the applications listed below, which require especially high reliability for the prevention of defects which might directly damage a third party's life, body or property, or when one of our products is intended for use in applications other than those specified in this catalog.

- | | |
|-----------------------------|--|
| ① Aircraft equipment | ② Aerospace equipment |
| ③ Undersea equipment | ④ Power plant equipment |
| ⑤ Medical equipment | ⑥ Transportation equipment (vehicles, trains, ships, etc.) |
| ⑦ Traffic signal equipment | ⑧ Disaster prevention / crime prevention equipment |
| ⑨ Data-processing equipment | ⑩ Application of similar complexity and/or reliability requirements to the applications listed above |

3. Product specifications in this catalog are as of July 2006. They are subject to change or our products in it may be discontinued without advance notice. Please check with our sales representatives or product engineers before ordering. If there are any questions, please contact our sales representatives or product engineers.

4. Please read rating and △CAUTION (for storage, operating, rating, soldering, mounting and handling) in this catalog to prevent smoking and/or burning, etc.

5. This catalog has only typical specifications because there is no space for detailed specifications. Therefore, please approve our product specifications or transact the approval sheet for product specifications before ordering.

6. Please note that unless otherwise specified, we shall assume no responsibility whatsoever for any conflict or dispute that may occur in connection with the effect of our and/or a third party's intellectual property rights and other related rights in consideration of your use of our products and/or information described or contained in our catalogs. In this connection, no representation shall be made to the effect that any third parties are authorized to use the rights mentioned above under licenses without our consent.

7. No ozone depleting substances (ODS) under the Montreal Protocol are used in our manufacturing process.