

## PC8477B (SuperFDC™) Advanced Floppy Disk Controller

### General Description

The PC8477B CMOS advanced floppy disk controller is an enhanced version of National's DP8473 floppy controller. The PC8477B is software compatible with the DP8473 and NEC  $\mu$ PD765 floppy disk controllers. In addition, it is pin and software compatible with the Intel 82077AA floppy controller. The PC8477B, a 24 MHz crystal, a device chip select, and a resistor package are all that is needed for a complete PC-AT®, PS/2® or EISA floppy controller solution.

The PC8477B includes advanced features such as a 16 byte FIFO (Burst and Non-Burst modes), support of Perpendicular Recording Mode disk drives, PS/2 diagnostic registers for Model 30 and Models 50/60/80, standard CMOS disk I/O, and additional commands to control these new features. The 16 byte FIFO will increase system performance at higher data rates and with multi-tasking bus structures. This controller is designed to fit into all PC-AT, EISA, and PS/2 designs, as well as other advanced applications.

### Features

- Pin and software compatible with Intel 82077AA FDC
- Software compatible with NSC's DP8473

- 16 byte FIFO (default disabled)
    - Burst and Non-Burst modes
    - Programmable threshold
  - Perpendicular Mode Recording drive support
  - High performance internal analog data separator (no external filter components required)
  - Low power CMOS with manual power down mode
  - Automatic power down mode, for complete software transparency
  - Integrates all PC-AT, and PS/2 logic
    - On chip Oscillator
    - PC compatible FDC address decode
    - PS/2 Model 30 and Model 50/60/80 diagnostic registers
    - DMA control circuitry
    - High current CMOS disk interface outputs
    - Data Rate and Digital Output registers
    - 12 mA  $\mu$ P bus interface buffers
  - Data Rate Support: 250/300 kb/s, 500 kb/s, and 1 Mb/s
  - Write precompensation software programmable
  - 68 pin PLCC package
  - 60 pin PQFP package
- Ideal for space limited applications

### Functional Block Diagram

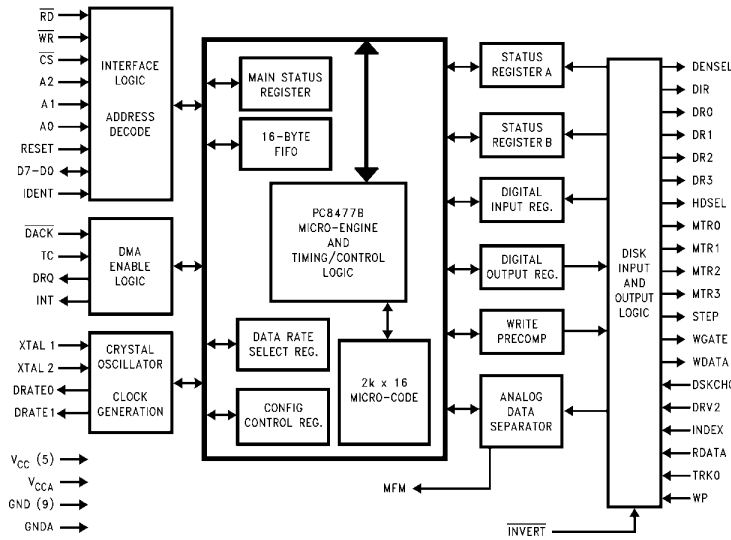

FIGURE 1-1

TL/F/11332-3

SuperFDC™ is a trademark of National Semiconductor Corporation.  
TRI-STATE® is a registered trademark of National Semiconductor Corporation.  
IBM®, PC-AT® and PS/2® are registered trademarks of International Business Machines Corp.

## Table of Contents

### 1.0 INTRODUCTION

### 2.0 PIN DESCRIPTION

### 3.0 REGISTER DESCRIPTION

- 3.1 Status Register A (SRA)
  - 3.1.1 SRA—PS/2 Mode
  - 3.1.2 SRA—Model 30 Mode
- 3.2 Status Register B (SRB)
  - 3.2.1 SRB—PS/2 Mode
  - 3.2.2 SRB—Model 30 Mode
- 3.3 Digital Output Register (DOR)
- 3.4 Tape Drive Register (TDR)
- 3.5 Main Status Register (MSR)
- 3.6 Data Rate Select Register (DSR)
- 3.7 Data Register (FIFO)
- 3.8 Digital Input Register (DIR)
  - 3.8.1 DIR—PC-AT Mode
  - 3.8.2 DIR—PS/2 Mode
  - 3.8.3 DIR—Model 30 Mode
- 3.9 Configuration Control Register (CCR)
  - 3.9.1 CCR—PC-AT and PS/2 Modes
  - 3.9.2 CCR—Model 30 Mode
- 3.10 Result Phase Status Registers
  - 3.10.1 Status Register 0 (ST0)
  - 3.10.2 Status Register 1 (ST1)
  - 3.10.3 Status Register 2 (ST2)
  - 3.10.4 Status Register 3 (ST3)

### 4.0 COMMAND SET DESCRIPTION

- 4.1 Command Set Summary
- 4.2 Command Description
  - 4.2.1 Configure Command
  - 4.2.2 Dumpreg Command
  - 4.2.3 Format Command
  - 4.2.4 Invalid Command
  - 4.2.5 Lock Command
  - 4.2.6 Mode Command
  - 4.2.7 NSC Command
  - 4.2.8 Perpendicular Mode Command
  - 4.2.9 Read Data Command
  - 4.2.10 Read Deleted Data Command
  - 4.2.11 Read ID Command
  - 4.2.12 Read A Track Command
  - 4.2.13 Recalibrate Command
  - 4.2.14 Relative Seek Command

- 4.2.15 Scan Commands
- 4.2.16 Seek Command
- 4.2.17 Sense Drive Status Command
- 4.2.18 Sense Interrupt Command
- 4.2.19 Set Track Command
- 4.2.20 Specify Command
- 4.2.21 Verify Command
- 4.2.22 Version Command
- 4.2.23 Write Data Command
- 4.2.24 Write Deleted Data Command

### 5.0 FUNCTIONAL DESCRIPTION

- 5.1 Microprocessor Interface
- 5.2 Modes of Operation
- 5.3 Controller Phases
  - 5.3.1 Command Phase
  - 5.3.2 Execution Phase
    - 5.3.2.1 DMA Mode—FIFO Disabled
    - 5.3.2.2 DMA Mode—FIFO Enabled
    - 5.3.2.3 Interrupt Mode—FIFO Disabled
    - 5.3.2.4 Interrupt Mode—FIFO Enabled
    - 5.3.2.5 Software Polling
  - 5.3.3 Result Phase
  - 5.3.4 Idle Phase
  - 5.3.5 Drive Polling Phase
- 5.4 Data Separator
- 5.5 Crystal Oscillator
- 5.6 Dynamic Window Margin Performance
- 5.7 Perpendicular Recording Mode
- 5.8 Data Rate Selection
- 5.9 Write Precompensation
- 5.10 Low Power Mode Logic
- 5.11 Reset Operation

### 6.0 DEVICE DESCRIPTION

- 6.1 DC Electrical Characteristics
- 6.2 AC Electrical Characteristics
  - 6.2.1 AC Test Conditions
  - 6.2.2 Clock Timing
  - 6.2.3 Microprocessor Read Timing
  - 6.2.4 Microprocessor Write Timing
  - 6.2.5 DMA Timing
  - 6.2.6 Reset Timing
  - 6.2.7 Write Data Timing
  - 6.2.8 Drive Control Timing
  - 6.2.9 Read Data Timing

### 7.0 REFERENCE SECTION

- 7.1 Mnemonic Definitions for PC8477B Commands
- 7.2 PC8477B Enhancements vs. 82077AA
- 7.3 PC8477B Interface in a PC-AT
- 7.4 Software Initialization Sequence
- 7.5 PC8477B/PC8477A differences
- 7.6 Revision History

## List of Figures

PC8477B Functional Block Diagram .....	1-1
PC8477B Pin Diagram for 68 Pin PLCC and 60 Pin PQFP .....	1-2
IBM®, Perpendicular, and ISO Formats Supported by Format Command .....	4-1
PC8477B Data Separator Block Diagram .....	5-1
Read Data Algorithm—State Diagram .....	5-2
PC8477B Dynamic Window Margin Performance .....	5-3
PC8477B Dynamic Window Margin Performance with $\pm 3\%$ ISV .....	5-4
Perpendicular Recording Drive R/W Head and Pre-Erase Head .....	5-5
Clock Timing .....	6-1
Microprocessor Read Timing .....	6-2
Microprocessor Write Timing .....	6-3
DMA Timing .....	6-4
Reset Timing .....	6-5
Write Data Timing .....	6-6
Drive Control Timing .....	6-7
Read Data Timing .....	6-8
PC8477B in a PC-AT System .....	7-1
PC84777B Initialization .....	7-2

## List of Tables

Register Description and Addresses .....	3-1
Drive Enable Values .....	3-2
Tape Drive Assignment Values .....	3-3
Write Precompensation Delays .....	3-4
Default Precompensation Delays .....	3-5
Data Rate Select Encoding .....	3-6
Typical Format Gap Length Values .....	4-1
DENSEL Encoding .....	4-2
DENSEL Default Encoding .....	4-3
Effects of WGATE and GAP .....	4-4
Sector Size Selection .....	4-5
SK Effect of Read Data Command .....	4-6
Result Phase Termination Values with No Error .....	4-7
SK Effect on Read Deleted Data Command .....	4-8
Maximum Recalibrate Step Pulses Based on R255 and ETR .....	4-9
Scan Command Termination Values .....	4-10
Status Register 0 Termination Codes .....	4-11
Set Track Register Address .....	4-12
Step Rate (SRT) Values .....	4-13
Motor Off Time (MFT) Values .....	4-14
Motor On Time (MNT) Values .....	4-15
Verify Command Result Phase Table .....	4-16
Nominal $t_{ICP}$ , $t_{DRP}$ Values .....	6-1
Minimum $t_{WDW}$ Values .....	6-2
PC8477B–82077 Parameter Comparison .....	7-1
Density Encoding .....	7-2

## 1.0 Introduction

The PC8477B advanced floppy disk controller is suitable for all PC-AT, EISA, PS/2, and general purpose applications. The operational mode (PC-AT, PS/2, and Model 30) of the PC8477B is determined by hardware strapping of the IDENT and MFM pins. DP8473 and Intel 82077AA software compatibility is provided. Key features include the 16 byte FIFO, PS/2 diagnostic register support, the perpendicular recording mode, CMOS disk interface, and a high performance analog data separator.

The PC8477B supports the standard PC data rates of 250, 300, 500 kb/s, and 1 Mb/s in MFM encoded data mode, but is no longer guaranteed through functional testing to support the older FM encoded data mode. References to the older FM mode remain in this document to clarify the true functional operation of the device.

The 1 Mb/s data rate is used by new high performance tape and floppy drives emerging in the PC market today. The new floppy drives utilize high density media which requires the PC8477B supported perpendicular recording mode format. When used with the 1 Mb/s data rate this new format allows the use of 4 Mb floppy drives which format ED media to 2.88 MB data capacity.

The high performance internal analog data separator needs no external components. It improves on the window margin performance standards of the DP8473, and is compatible with the strict data separator requirements of floppy and floppy-tape drives.

The PC8477B contains write precompensation and circuitry that will default to 125 ns for 250, 300, and 500 kb/s, 41.67 ns at 1 Mb/s. These values can be overridden through software to disable write precompensation or to provide levels of precompensation up to 250 ns. The PC8477B has internal 12 mA data bus buffers which allow direct connection to the system bus. The internal 48 mA totem-pole disk interface buffers are compatible with both CMOS drive inputs and 150 $\Omega$  resistor terminated disk drive inputs.

The PC8477B is available in a 68 pin Plastic Leaded Chip Carrier (PLCC) package, and in a 60 pin Plastic Quad Flat Package (PQFP).

## Connection Diagrams

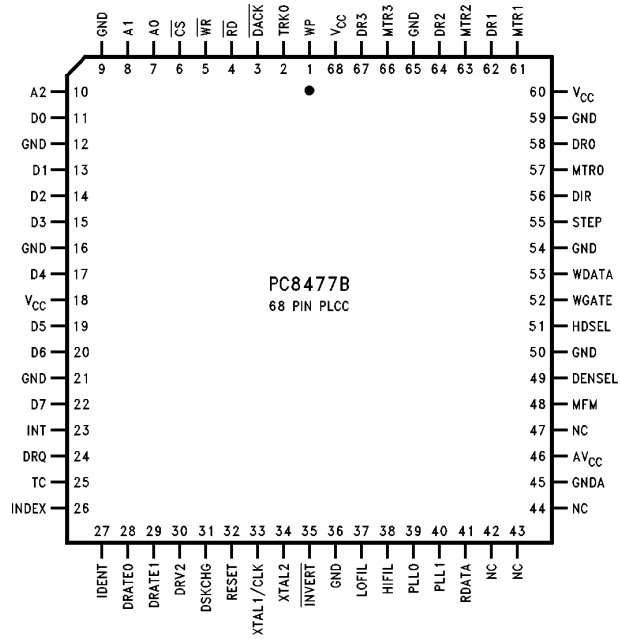

**Plastic Chip Carrier (V)**  
**Order Number PC8477BV-1**  
**See NS Package Number V68A**

TL/F/11332-1

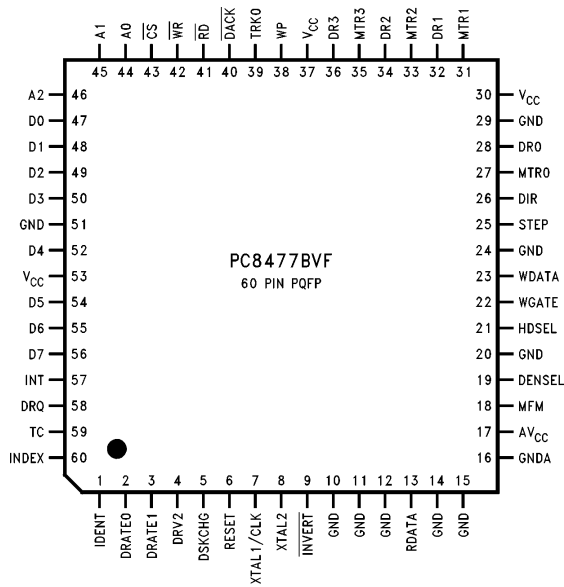

**Plastic Quad Flat Package (VF)**  
**Order Number PC8477BVF-1**  
**See NS Package Number VF60A**

TL/F/11332-2

**FIGURE 1-2**

## 2.0 Pin Description

Symbol	PLCC Pin	PQFP Pin	I/O	Function
A0 A1 A2	7 8 10	44 45 46	I	<b>Address.</b> These address lines from the microprocessor determine which internal FDC register is accessed. See TABLE 3-1 in the Register Description section. A0–A2 are don't cares during a DMA transfer.
AVCC	46	17		<b>Analog Supply.</b> This pin is the 5V supply for the analog data separator.
$\overline{CS}$	6	43	I	<b>Chip Select.</b> Active low input from address decoder used to enable the $\overline{RD}$ and $\overline{WR}$ inputs during register I/O. Should be held inactive during DMA transfers.
D0 D1 D2 D3 D4 D5 D6 D7	11 13 14 15 17 19 20 22	47 48 49 50 52 54 55 56	I/O	<b>Data.</b> Bi-directional data lines to the microprocessor. D0 is the LSB and D7 is the MSB. These signals all have 12 mA buffered outputs.
$\overline{DACK}$	3	40	I	<b>DMA Acknowledge.</b> Active low input to acknowledge the DMA request and enable the $\overline{RD}$ and $\overline{WR}$ inputs during a DMA transfer. $\overline{DACK}$ should be held inactive high during normal read or write accesses when $\overline{CS}$ is active. When in PC-AT or Model 30 mode, this signal is enabled by bit D3 of the DOR. When in PS/2 mode, $\overline{DACK}$ is always enabled, and bit D3 of the DOR is reserved.
DENSEL	49	19	O	<b>Density Select.</b> Indicates when a high density data rate (500 kb/s or 1 Mb/s) or a low density data rate (250 or 300 kb/s) has been selected. DENSEL is active high for high density (5.25" drives) when IDENT is high, and active low for high density (3.5" drives) when IDENT is low. DENSEL is also programmable via the Mode command (see Section 4.2.6).
DIR	56	26	O	<b>Direction.</b> This output determines the direction of the head movement (active = step in, inactive = step out) during a seek operation. During read or writes, DIR will be inactive.
DR0 DR1 DR2 DR3	58 62 64 67	28 32 34 36	O	<b>Drive Select 0–3.</b> These are the decoded drive select outputs that are controlled by Digital Output Register bits D0, D1. The Drive Select outputs are gated by DOR bits 4–7.
DRATE0 DRATE1	28 29	2 3	O	<b>Data Rate 0,1.</b> These outputs reflect the currently selected data rate, (bits 0 and 1 in the CCR or the DSR, whichever was written to last). These pins are totem-pole buffered outputs (6 mA sink, 4 mA source).
DRQ	24	58	O	<b>DMA Request.</b> Active high output to signal the DMA controller that a data transfer is needed. When in PC-AT or Model 30 mode, this signal is enabled by bit D3 of the DOR. When in PS/2 mode, DRQ is always enabled, and bit D3 of the DOR is reserved.
DRV2	30	4	I	<b>Drive2.</b> This input indicates whether a second disk drive has been installed. The state of this pin is available from Status Register A in PS/2 mode.
DSKCHG	31	5	I	<b>Disk Change.</b> The input indicates if the drive door has been opened. The state of this pin is available from the Digital Input register. This pin can also be configured as the RGATE data separator diagnostic input via the Mode command (see Section 4.2.6).
GND	9, 12, 16, 21, 36, 50, 54, 59, 65	10, 11, 12, 14, 15, 20, 24, 29, 51		<b>Ground</b>
GNDA	45	16		<b>Analog Ground.</b> This is the analog ground for the data separator.

## 2.0 Pin Description (Continued)

Symbol	PLCC Pin	PQFP Pin	I/O	Function															
HDSEL	51	21	O	<b>Head Select.</b> This output determines which side of the disk drive is accessed. Active selects side 1, inactive selects side 0.															
HIFIL	38	(Note 1)		<b>High Filter.</b> No connect. No external capacitor is required. An external capacitor can be connected, but it will have no effect on the data separator performance.															
IDENT	27	1	I	<p><b>Identity.</b> During chip reset, the IDENT and MFM pins are sampled to determine the mode of operation according to the following table:</p> <table border="1" style="margin-left: auto; margin-right: auto;"> <thead> <tr> <th>IDENT</th> <th>MFM</th> <th>Mode</th> </tr> </thead> <tbody> <tr> <td>1</td> <td>1 or NC</td> <td>PC-AT Mode</td> </tr> <tr> <td>1</td> <td>0</td> <td>Illegal</td> </tr> <tr> <td>0</td> <td>1 or NC</td> <td>PS/2 Mode</td> </tr> <tr> <td>0</td> <td>0</td> <td>Model 30 Mode</td> </tr> </tbody> </table> <p><b>AT Mode</b>—The DMA enable bit in the DOR is valid. TC is active high. Status Registers A and B are disabled (TRI-STATE®).</p> <p><b>Model 30 Mode</b>—The DMA enable bit in the DOR is valid. TC is active high. Status Registers A and B are enabled.</p> <p><b>PS/2 Mode</b>—The DMA enable bit in the DOR is a don't care, and the DRQ and INT signals will always be enabled. TC is active low. Status Registers A and B are enabled.</p> <p>After chip reset, the state of IDENT determines the polarity of the DENSEL output. When IDENT is a logic "1", DENSEL is active high for 500 kb/s and 1 Mb/s data rates. When IDENT is a logic "0", DENSEL is active low for 500 kb/s and 1 Mb/s data rates. (See Mode command for further explanation of DENSEL.)</p>	IDENT	MFM	Mode	1	1 or NC	PC-AT Mode	1	0	Illegal	0	1 or NC	PS/2 Mode	0	0	Model 30 Mode
IDENT	MFM	Mode																	
1	1 or NC	PC-AT Mode																	
1	0	Illegal																	
0	1 or NC	PS/2 Mode																	
0	0	Model 30 Mode																	
INDEX	26	60	I	<b>Index.</b> This input signals the beginning of a track.															
INT	23	57	O	<b>Interrupt.</b> Active high output to signal the completion of the execution phase for certain commands. Also used to signal when a data transfer is ready during a Non-DMA operation. When in PC-AT or Model 30 mode, this signal is enabled by bit D3 of the DOR. When in PS/2 mode, INT is always enabled, and bit D3 of the DOR is reserved.															
INVERT	35	9	I	<b>Invert.</b> Determines the polarity of all disk interface signals. When tied low, the internal disk output buffers and inverting Schmitt input receivers are enabled, and the disk interface signals are active low. When tied high, the disk interface signals are active high, and external receivers and output buffers are required.															
LOFIL	37	(Note 1)		<b>Low Filter.</b> No connect. No external capacitor is required. An external capacitor can be connected, but it will have no effect on the data separator performance.															
MFM	48	18	I/O	<b>MFM.</b> During a chip reset when in PS/2 mode (IDENT low), this pin is sampled to select the PS/2 mode (MFM high), or the Model 30 mode (MFM low). An internal pull-up or external pull-down 10 kΩ resistor will select between the two PS/2 modes. When the PC-AT mode is desired (IDENT high), MFM should be left pulled high internally. MFM reflects the current data encoding format when RESET is inactive. MFM = high, FM = low. Defaults to low after a chip reset. This signal can also be configured as the PUMP data separator diagnostic output via the Mode command (see Section 4.2.6).															
MTR0 MTR1 MTR2 MTR3	57 61 63 66	27 31 33 35	O	<b>Motor Select 0–3.</b> These are the motor enable lines for drives 0–3, and are controlled by bits D7–D4 of the Digital Output register.															
NC	42 43 44 47	(Note 1)		<b>No Connect.</b> These pins must be left unconnected.															

## 2.0 Pin Description (Continued)

Symbol	PLCC Pin	PQFP Pin	I/O	Function
PLL0 PLL1	39 40	(Note 1)		<b>Phase Locked Loop 0,1.</b> No connects. These pins can be tied high or low with no affect on the data separator performance.
$\overline{RD}$	4	41	I	<b>Read.</b> Active low input to signal a read from the controller to the microprocessor.
RDATA	41	13	I	<b>Read Data.</b> This input is the raw serial data read from the disk drive.
RESET	32	6	I	<b>Reset.</b> Active high input that resets the controller to the idle state, and resets all disk interface outputs to their inactive states. The DOR, DSR, CCR, Mode command, Configure command, and Lock command parameters are cleared to their default values. The Specify command parameters are not affected.
STEP	55	25	O	<b>Step.</b> This output signal issues pulses to the disk drive at a software programmable rate to move the head during a seek operation.
TC	25	59	I	<b>Terminal Count.</b> Control signal from the DMA controller to indicate the termination of a DMA transfer. TC is accepted only when $\overline{DACK}$ is active. TC is active high in PC-AT and Model 30 modes, and active low in PS/2 mode.
TRK0	2	39	I	<b>Track 0.</b> This input indicates to the controller that the head of the selected disk drive is at track zero.
V <sub>CC</sub>	18 60 68	30 37 53		<b>Voltage.</b> This is the +5V supply voltage for the digital circuitry.
WDATA	53	23	O	<b>Write Data.</b> This output is the write precompensated serial data that is written to the selected disk drive. Precompensation is software selectable.
WGATE	52	22	O	<b>Write Gate.</b> This output signal enables the write circuitry of the selected disk drive. WGATE has been designed to prevent glitches during power up and power down. This prevents writing to the disk when power is cycled.
WP	1	38	I	<b>Write Protect.</b> This input indicates that the disk in the selected drive is write protected.
$\overline{WR}$	5	42	I	<b>Write.</b> Active low input to signal a write from the microprocessor to the controller.
XTAL1/CLK	33	7	I	<b>Crystal1/Clock.</b> One side of an external 24 MHz crystal is attached here. If a crystal is not used, a TTL or CMOS compatible clock is connected to this pin.
XTAL2	34	8	I	<b>Crystal2.</b> One side of an external 24 MHz crystal is attached here. This pin is left unconnected if an external clock is used.

**Note 1:** When converting the 68 pin PLCC to a 60 pin PQFP, eight pins were removed. The following signals were affected in this conversion process:

1. NC (No Connect) signals on pins 42 and 43 of the 68 pin PLCC were converted to GND (Ground) signals on pins 14 and 15 of the 60 pin PQFP, respectively.
2. NC (No Connect) signals on pins 44 and 47 of the 68 pin PLCC were removed for the 60 pin PQFP.
3. HIFIL (pin 38) and LOFIL (pin 37) of the 68 pin PLCC were removed for the 60 pin PQFP.
4. PLL0 (pin 39) and PLL1 (pin 40) of the 68 PLCC were converted to GND (ground) signals on the PQFP (pins 11 and 12 respectively).
5. The GND (ground) signals on pins 9, 12, 21, and 65 of the 68 pin PLCC are not available for the 60 pin PQFP. These signals are tied to ground internally.



### 3.0 Register Description

The following PC8477B registers are mapped into the addresses shown below, with the base address range being provided by the CS pin. For PC-AT or PS/2 applications, the diskette controller primary address range is 3F0 to 3F7 (hex), and the secondary address range is 370 to 377 (hex). The PC8477B supports three different register modes: the

PC-AT mode, PS/2 mode (Models 50/60/80), and the Model 30 mode (Model 30). See Section 5.1 for more details on how each register mode is enabled. When applicable, the register definition for each mode of operation will be given. If no special notes are made, then the register is valid for all three register modes.

TABLE 3-1. Register Description and Addresses

A2	A1	A0	IDENT	R/W	Register	
0	0	0	0	R	Status Register A	SRA
0	0	1	0	R	Status Register B	SRB
0	1	0	X	R/W	Digital Output Register	DOR
0	1	1	X	R/W	Tape Drive Register	TDR
1	0	0	X	R	Main Status Register	MSR
1	0	0	X	W	Data Rate Select Register	DSR
1	0	1	X	R/W	Data Register (FIFO)	FIFO
1	1	0	X	X	None (Bus TRI-STATE)	
1	1	1	X	R	Digital Input Register	DIR
1	1	1	X	W	Configuration Control Register	CCR

Note: SRA and SRB are enabled by IDENT = 0 during a chip reset only.

#### 3.1 STATUS REGISTER A (SRA) Read Only

This is a read only diagnostic register that is part of the PS/2 floppy controller register set, and is enabled when in the PS/2 or Model 30 mode. This register monitors the state of the INT pin and some of the disk interface signals. The state of these bits is independent of the INVERT pin. The SRA can be read at any time when in PS/2 mode. In the PC-AT mode, D7–D0 are TRI-STATE during a μP read.

##### 3.1.1 SRA—PS/2 Mode

	D7	D6	D5	D4	D3	D2	D1	D0
DESC	INT PENDING	DRV2	STEP	TRK0	HDSEL	INDX	WP	DIR
RESET COND	0	N/A	0	N/A	0	N/A	N/A	0

- D7** **Interrupt Pending:** This active high bit reflects the state of the INT pin.
- D6** **2nd Drive Installed:** Active low status of the DRV2 disk interface input, indicating if a second drive has been installed.
- D5** **Step:** Active high status of the STEP disk interface output.
- D4** **Track 0:** Active low status of the TRK0 disk interface input.
- D3** **Head Select:** Active high status of the HDSEL disk interface output.
- D2** **Index:** Active low status of the INDEX disk interface input.
- D1** **Write Protect:** Active low status of the WP disk interface input.
- D0** **Direction:** Active high status of the DIR disk interface output.

##### 3.1.2 SRA—Model 30 Mode

	D7	D6	D5	D4	D3	D2	D1	D0
DESC	INT PENDING	DRQ	STEP	TRK0	HDSEL	INDX	WP	DIR
RESET COND	0	0	0	N/A	1	N/A	N/A	1

- D7** **Interrupt Pending:** This active high bit reflects that state of the INT pin.
- D6** **DMA Request:** Active high status of the DRQ signal.
- D5** **Step:** Active high status of the latched STEP disk interface output. This bit is latched with the STEP output going active, and is cleared with a read from the DIR, or with a hardware or software reset.
- D4** **Track 0:** Active high status of TRK0 disk interface input.
- D3** **Head Select:** Active low status of the HDSEL disk interface output.
- D2** **Index:** Active high status of the INDEX disk interface input.
- D1** **Write Protect:** Active high status of the WP disk interface input.
- D0** **Direction:** Active low status of the DIR disk interface output.

#### 3.2 STATUS REGISTER B (SRB) Read Only

This is a read only diagnostic register that is part of the PS/2 floppy controller register set, and is enabled when in the PS/2 or Model 30 mode. The state of these bits is independent of the INVERT pin. The SRB can be read at any time when in PS/2 mode. In the PC-AT mode, D7–D0 are TRI-STATE during a μP read.

### 3.0 Register Description (Continued)

#### 3.2.1 SRB—PS/2 Mode

	D7	D6	D5	D4	D3	D2	D1	D0
DESC	1	1	DR0	WDATA	RDATA	WGATE	MTR1	MTR0
RESET COND	N/A	N/A	0	0	0	0	0	0

- D7** **Reserved:** Always 1.
- D6** **Reserved:** Always 1.
- D5** **Drive Select 0:** Reflects the status of the Drive Select 0 bit in the DOR (address 2, bit 0). This bit is cleared after a hardware reset, not a software reset.
- D4** **Write Data:** Every inactive edge transition of the WDATA disk interface output causes this bit to change states.
- D3** **Read Data:** Every positive edge transition of the RDATA disk interface output causes this bit to change states.
- D2** **Write Gate:** Active high status of the WGATE disk interface output.
- D1** **Motor Enable 1:** Active high status of the MTR1 disk interface output. Low after a hardware reset, unaffected by a software reset.
- D0** **Motor Enable 0:** Active high status of the MTR0 disk interface output. Low after a hardware reset, unaffected by a software reset.

#### 3.2.2 SRB—Model 30 Mode

	D7	D6	D5	D4	D3	D2	D1	D0
DESC	DRV2	DR1	DR0	WDATA	RDATA	WGATE	DR3	DR2
RESET COND	N/A	1	1	0	0	0	1	1

- D7** **2nd Drive Installed:** Active low status of the DRV2 disk interface input.
- D6** **Drive Select 1:** Active low status of the DR1 disk interface output.
- D5** **Drive Select 0:** Active low status of the DR0 disk interface output.
- D4** **Write Data:** Active high status of latched WDATA signal. This bit is latched by the inactive going edge of WDATA and is cleared by a read from the DIR. This bit is not gated by WGATE.
- D3** **Read Data:** Active high status of latched RDATA signal. This bit is latched by the inactive going edge of RDATA and is cleared by a read from the DIR.
- D2** **Write Gate:** Active high status of latched WGATE signal. This bit is latched by the active going edge of WGATE and is cleared by a read from the DIR.
- D1** **Drive Select 3:** Active low status of the DR3 disk interface output.
- D0** **Drive Select 2:** Active low status of the DR2 disk interface output.

#### 3.3 DIGITAL OUTPUT REGISTER (DOR) Read/Write

The DOR controls the drive select and motor enable disk interface outputs, enables the DMA logic, and contains a software reset bit. The contents of the DOR are set to 00 (hex) after a hardware reset, and are unaffected by a software reset. The DOR can be written to at any time.

#### DOR

	D7	D6	D5	D4	D3	D2	D1	D0
DESC	MTR3	MTR2	MTR1	MTR0	DMAEN	RESET	DRIVE SEL 1	DRIVE SEL 0
RESET COND	0	0	0	0	0	0	0	0

- D7** **Motor Enable 3:** This bit controls the MTR3 disk interface output. A 1 in this bit causes the MTR3 pin to go active. The actual level of MTR3 depends on the state of the INVERT pin.
- D6** **Motor Enable 2:** Same function as D7 except for MTR2.
- D5** **Motor Enable 1:** Same function as D7 except for MTR1.
- D4** **Motor Enable 0:** Same function as D7 except for MTR0.
- D3** **DMA Enable:** This bit has two modes of operation. **PC-AT mode or Model 30 mode:** Writing a 1 to this bit will enable the DRQ,  $\overline{DAK}$ , INT and TC pins. Writing a 0 to this bit will TRI-STATE DRQ and INT, and disable  $\overline{DAK}$  and TC. This bit is a 0 after a reset when in these modes. **PS/2 mode:** This bit is reserved, and the DRQ,  $\overline{DAK}$ , INT and TC pins will always be enabled. During a reset, the DRQ,  $\overline{DAK}$ , and INT lines will remain enabled, and D3 will be a 0.
- D2** **Reset Controller:** Writing a 0 to this bit resets the controller. It will remain in the reset condition until a 1 is written to this bit. A software reset does not affect the DSR, CCR, and other bits of the DOR. A software reset will affect the Configure and Mode command bits (see Section 4.0 Command Set Description). The minimum time that this bit must be low is 100 ns. Thus, toggling the Reset Controller bit during consecutive writes to the DOR is an acceptable method of issuing a software reset.
- D1–D0** **Drive Select:** These two bits are binary encoded for the four drive selects DR0–DR3, so that only one drive select output is active at a time. The actual level of the drive select outputs is determined by the state of the INVERT pin.

It is common programming practice to enable both the motor enable and drive select outputs for a particular drive. Table 3-2 below shows the DOR values to enable each of the four drives.

TABLE 3-2. Drive Enable Values

Drive	DOR Value
0	1C (Hex)
1	2D
2	4E
3	8F

### 3.0 Register Description (Continued)

#### 3.4 DRIVE REGISTER (TDR) Read/Write

This register is used to assign a particular drive number with the tape drive support mode of the data separator. All other logical drives are assigned floppy drive support with the data separator. Any future reference to the assigned tape drive will invoke tape drive support. The TDR is unaffected by a software reset.

##### TDR

	D7	D6	D5	D4	D3	D2	D1	D0
DESC	X	X	X	X	X	X	TAPE SEL1	TAPE SEL0
RESET COND	N/A	N/A	N/A	N/A	N/A	N/A	0	0

**D7-D2 Reserved:** These bits are ignored when written to and are TRI-STATE when read.

**D1-D0 Tape Select 1,0:** These two bits assign a logical drive number to be a tape drive. Drive 0 is not available as a tape drive, and is reserved as the floppy disk boot drive. See Table 3-3 for the tape drive assignment values.

TABLE 3-3. Tape Drive Assignment Values

TAPSEL1	TAPSEL0	DRIVE SELECTED
0	0	None
0	1	1
1	0	2
1	1	3

#### 3.5 MAIN STATUS REGISTER (MSR) Read Only

The read only Main Status Register indicates the current status of the disk controller. The Main Status Register is always available to be read. One of its functions is to control the flow of data to and from the Data Register (FIFO). The Main Status Register indicates when the disk controller is ready to send or receive data through the Data Register. It should be read before each byte is transferred to or from the Data Register except during a DMA transfer. No delay is required when reading this register after a data transfer.

After a hardware or software reset, or recovery from a power down state, the Main Status Register is immediately available to be read by the  $\mu$ P. It will contain a value of 00 hex until the oscillator circuit has stabilized, and the internal registers have been initialized. When the PC8477B is ready to receive a new command, it will report an 80 hex to the  $\mu$ P. The system software can poll the MSR until it is ready. The worst case time allowed for the MSR to report an 80 hex value (RQM set) is 2.5  $\mu$ s after reset or power up.

##### MSR

	D7	D6	D5	D4	D3	D2	D1	D0
DESC	RQM	DIO	NON DMA	CMD PROG	DRV3 BUSY	DRV2 BUSY	DRV1 BUSY	DRV0 BUSY
RESET COND	0	0	0	0	0	0	0	0

**D7 Request for Master:** Indicates that the controller is ready to send or receive data from the  $\mu$ P through the FIFO. This bit is cleared immediately after a byte transfer and will become set again as soon as the disk controller is ready for the next byte. During a Non-DMA Execution phase, the RQM indicates the status of the interrupt pin.

**D6 Data I/O (Direction):** Indicates whether the controller is expecting a byte to be written to (0) or read from (1) the Data Register.

**D5 Non-DMA Execution:** Indicates that the controller is in the Execution Phase of a byte transfer operation in the Non-DMA mode. Used for multiple byte transfers by the  $\mu$ P in the Execution Phase through interrupts or software polling.

**D4 Command in Progress:** This bit is set after the first byte of the Command Phase is written. This bit is cleared after the last byte of the Result Phase is read. If there is no Result Phase in a command, the bit is cleared after the last byte of the Command Phase is written.

**D3 Drive 3 Busy:** Set after the last byte of the Command Phase of a Seek or Recalibrate command is issued for drive 3. Cleared after reading the first byte in the Result Phase of the Sense Interrupt Command for this drive.

**D2 Drive 2 Busy:** Same as above for drive 2.

**D1 Drive 1 Busy:** Same as above for drive 1.

**D0 Drive 0 Busy:** Same as above for drive 0.

#### 3.6 DATA RATE SELECT REGISTER (DSR) Write Only

This write only register is used to program the data rate, amount of write precompensation, power down mode, and software reset. The data rate is programmed via the CCR, not the DSR, for PC-AT and PS/2 Model 30 and MicroChannel applications. Other applications can set the data rate in the DSR. The data rate of the floppy controller is determined by the most recent write to either the DSR or CCR. The DSR is unaffected by a software reset. A hardware reset will set the DSR to 02 (hex), which corresponds to the default precompensation setting and 250 kb/s.

##### DSR

	D7	D6	D5	D4	D3	D2	D1	D0
DESC	S/W RESET	LOW PWR	0	PRE-COMP2	PRE-COMP1	PRE-COMP0	DRATE1	DRATE0
RESET COND	0	0	0	0	0	0	1	0

**D7 Software Reset:** A 1 in this bit location will reset the part similar to the DOR RESET (D2) except that this software reset is self-clearing.

**D6 Low Power:** A 1 to this bit will put the controller into the Manual Low Power mode. The oscillator and data separator circuits will be turned off. Manual Low Power can also be accessed via the Mode command. The chip will come out of low power after a software reset, or access to the Data Register or Main Status Register.

### 3.0 Register Description (Continued)

- D5** **Undefined:** Should be set to 0.
- D4–D2** **Precompensation Select:** These three bits select the amount of write precompensation the floppy controller will use on the WDATA disk interface output. Table 3-4 shows the amount of precompensation used for each bit pattern. In most cases, the default values (Table 3-5) can be used; however, alternate values can be chosen for specific types of drives and media. Track 0 is the default starting track number for precompensation. The starting track number can be changed in the Configure command.
- D1–D0** **Data Rate Select 1,0:** These bits determine the data rate for the floppy controller. See Table 3-6 for the corresponding data rate for each value of D1, D0. The data rate select bits are unaffected by a software reset, and are set to 250 kb/s after a hardware reset.

**TABLE 3-4. Write Precompensation Delays**

PRECOMP 4 3 2	Precompensation Delay
1 1 1	0.0 ns
0 0 1	41.7 ns
0 1 0	83.3 ns
0 1 1	125.0 ns
1 0 0	166.7 ns
1 0 1	208.3 ns
1 1 0	250.0 ns
0 0 0	DEFAULT

**TABLE 3-5. Default Precompensation Delays**

Data Rate	Precompensation Delay
1 Mb/s	41.7 ns
500 kb/s	125.0 ns
300 kb/s	125.0 ns
250 kb/s	125.0 ns

**TABLE 3-6. Data Rate Select Encoding**

Data Rate Select		Data Rate	
1	2	MFM	FM
1	1	1 Mb/s	Illegal
0	0	500 kb/s	250 kb/s
0	1	300 kb/s	150 kb/s
1	0	250 kb/s	125 kb/s

**Note:** FM mode is not guaranteed through functional testing.

#### 3.7 DATA REGISTER (FIFO) Read/Write

The FIFO (read/write) is used to transfer all commands, data, and status between the  $\mu$ P and the PC8477B. During the Command Phase, the  $\mu$ P writes the command bytes into the FIFO after polling the RQM and DIO bits in the MSR. During the Result Phase, the  $\mu$ P reads the result bytes from the FIFO after polling the RQM and DIO bits in the MSR.

The enabling of the FIFO and setting of the FIFO threshold is done via the Configure command. If the FIFO is enabled,

only the Execution Phase byte transfers use the 16 byte FIFO. The FIFO is always disabled during the Command and Result Phases of a controller operation. If the FIFO is enabled, it will not be disabled after a software reset if the LOCK bit is set in the Lock Command. After a hardware reset, the FIFO is disabled to maintain compatibility with PC-AT systems.

The 16 byte FIFO can be used for DMA, Interrupt, or software polling type transfers during the execution of a read, write, format, or scan command. In addition, the FIFO can be put into a Burst or Non-Burst mode with the Mode command. In the Burst mode, DRQ or INT remains active until all of the bytes have been transferred to or from the FIFO. In the Non-Burst mode, DRQ or INT is deasserted for 350 ns to allow higher priority transfer requests to be serviced. The Mode command can also disable the FIFO for either reads or writes separately. The FIFO allows the system a larger latency without causing a disk overrun/underrun error. Typical uses of the FIFO would be at the 1 Mb/s data rate, or with multi-tasking operating systems. The default state of the FIFO is disabled, with a threshold of zero. The default state is entered after a hardware reset.

**Data Register (FIFO)**

	D7	D6	D5	D4	D3	D2	D1	D0
<b>DESC</b>	Data [7:0]							
<b>RESET COND</b>	Byte Mode							

During the Execution Phase of a command involving data transfer to/from the FIFO, the system must respond to a data transfer service request based on the following formula:

$$\text{Maximum Allowable Data Transfer Service Time} \\ (\text{THRESH} + 1) \times 8 \times t_{\text{DRP}} - (16 \times t_{\text{ICP}})$$

This formula is good for all data rates with the FIFO enabled or disabled. THRESH is a four bit value programmed in the Configure command, which sets the FIFO threshold. If the FIFO is disabled, THRESH is zero in the above formula. The last term of the formula,  $(16 \times t_{\text{ICP}})$  is an inherent delay due to the microcode overhead required by the PC8477B. This delay is also data rate dependent. See Table 6-1 for the  $t_{\text{DRP}}$  and  $t_{\text{ICP}}$  times.

The programmable FIFO threshold (THRESH) is useful in adjusting the floppy controller to the speed of the system. In other words, a slow system with a sluggish DMA transfer capability would use a high value of THRESH, giving the system more time to respond to a data transfer service request (DRQ for DMA mode or INT for Interrupt mode). Conversely, a fast system with quick response to a data transfer service request would use a low value of THRESH.

#### 3.8 DIGITAL INPUT REGISTER (DIR) Read Only

This diagnostic register is used to detect the state of the DSKCHG disk interface input and some diagnostic signals. The function of this register depends on the register mode of operation. When in the PC-AT mode, the D6–D0 are TRI-STATE to avoid conflict with the fixed disk status register at the same address. The DIR is unaffected by a software reset.

### 3.0 Register Description (Continued)

#### 3.8.1 DIR—PC-AT Mode

	D7	D6	D5	D4	D3	D2	D1	D0
DESC	DSKCHG	X	X	X	X	X	X	X
RESET COND	N/A	N/A	N/A	N/A	N/A	N/A	N/A	N/A

**D7** **Disk Changed:** Active high status of DSKCHG disk interface input, independent of INVERT value.

**D6–D0** **Undefined:** TRI-STATE. Used by hard disk controller status register.

#### 3.8.2 DIR—PS/2 Mode

	D7	D6	D5	D4	D3	D2	D1	D0
DESC	DSKCHG	1	1	1	1	DRATE1	DRATE0	HIGH DEN
RESET COND	N/A	N/A	N/A	N/A	N/A	N/A	N/A	1

**D7** **Disk Changed:** Active high status of DSKCHG disk interface input, independent of INVERT value.

**D6–D3** **Reserved:** Always 1.

**D2–D1** **Data Rate Select 1,0:** These bits indicate the status of the DRATE1–0 bits programmed through the DSR/CCR.

**D0** **High Density:** This bit is low when the 1 Mb/s or 500 kb/s data rate is chosen, and high when the 300 kb/s or 250 kb/s data rate is chosen. This bit is independent of the IDENT or INVERT value.

#### 3.8.3 DIR—Model 30 Mode

	D7	D6	D5	D4	D3	D2	D1	D0
DESC	DSKCHG	0	0	0	DMAEN	NOPRE	DRATE1	DRATE0
RESET COND	N/A	0	0	0	0	0	1	0

**D7** **Disk Changed:** Active low status of DSKCHG disk interface input, independent of INVERT value.

**D6–D4** **Reserved:** Always 0.

**D3** **DMA Enable:** Active high status of the DMAEN bit in the DOR.

**D2** **No Precompensation:** Active high status of the NOPRE bit in the CCR.

**D1–D0** **Data Rate Select 1,0:** These bits indicate the status of the DRATE1–0 bits programmed through the DSR/CCR.

#### 3.9 CONFIGURATION CONTROL REGISTER (CCR) Write Only

This is the write only data rate register commonly used in PC-AT applications. This register is not affected by a software reset, and is set to 250 kb/s after a hardware reset. The data rate of the floppy controller is determined by the last write to either the CCR or DSR.

#### 3.9.1 CCR—PC-AT and PS/2 Modes

	D7	D6	D5	D4	D3	D2	D1	D0
DESC	0	0	0	0	0	0	DRATE1	DRATE0
RESET COND	N/A	N/A	N/A	N/A	N/A	N/A	1	0

**D7–D2** **Reserved:** Should be set to 0.

**D1–D0** **Data Rate Select 1,0:** These bits determine the data rate of the floppy controller. See Table 3-6 for the appropriate values.

#### 3.9.2 CCR—Model 30 Mode

	D7	D6	D5	D4	D3	D2	D1	D0
DESC	0	0	0	0	0	NOPRE	DRATE1	DRATE0
RESET COND	N/A	N/A	N/A	N/A	N/A	0	1	0

**D7–D3** **Reserved:** Should be set to 0.

**D2** **No Precompensation:** This bit can be set by software, but it has no functionality. It can be read by bit D2 of the DIR when in the Model 30 register mode. Unaffected by a software reset.

**D1–D0** **Data Rate Select 1,0:** These bits determine the data rate of the floppy controller. See Table 3-6 for the appropriate values.

#### 3.10 RESULT PHASE STATUS REGISTERS

The Result Phase of a command contains bytes that hold status information. The format of these bytes are described below. Do not confuse these status bytes with the Main Status Register, which is a read only register that is always valid. The Result Phase status registers are read from the Data Register (FIFO) only during the Result Phase of certain commands (see Section 4.1 Command Set Summary). The status of each register bit is indicated when the bit is a 1.

##### 3.10.1 Status Register 0 (ST0)

	D7	D6	D5	D4	D3	D2	D1	D0
DESC	IC	IC	SE	EC	0	HDS	DS1	DS0
RESET COND	0	0	0	0	0	0	0	0

##### D7–D6 Interrupt Code:

00 = Normal Termination of Command.

01 = Abnormal Termination of Command. Execution of command was started, but was not successfully completed.

10 = Invalid Command Issued. Command issued was not recognized as a valid command.

11 = Internal drive ready status changed state during the drive polling mode. Only occurs after a hardware or software reset.

**D5** **Seek End:** Seek, Relative Seek, or Recalibrate command completed by the controller. (Used during a Sense Interrupt command.)

**D4** **Equipment Check:** After a Recalibrate command, Track 0 signal failed to occur. (Used during Sense Interrupt command.)

**D3** Not Used. Always 0.

### 3.0 Register Description (Continued)

**D2** **Head Select:** Indicates the active high status of the HDSEL pin at the end of the Execution Phase.

**D1–D0** **Drive Select 1,0:** These two binary encoded bits indicate the logical drive selected at the end of the Execution Phase.  
 00 = Drive 0 selected.  
 01 = Drive 1 selected.  
 10 = Drive 2 selected.  
 11 = Drive 3 selected.

#### 3.10.2 Status Register 1 (ST1)

	D7	D6	D5	D4	D3	D2	D1	D0
<b>DESC</b>	ET	0	CE	OR	0	ND	NW	MA
<b>RESET COND</b>	0	0	0	0	0	0	0	0

**D7** **End of Track:** Controller transferred the last byte of the last sector without the TC pin becoming active. The last sector is the End of Track sector number programmed in the Command Phase.

**D6** Not Used. Always 0.

**D5** **CRC Error:** If this bit is set and bit 5 of ST2 is clear, then there was a CRC error in the Address Field of the correct sector. If bit 5 of ST2 is also set, then there was a CRC error in the Data Field.

**D4** **Overrun:** Controller was not serviced by the  $\mu$ P soon enough during a data transfer in the Execution Phase. For read operations, indicates a data overrun. For write operations, indicates a data underrun.

**D3** Not Used. Always 0.

**D2** **No Data:** Three possible problems:

1. Controller cannot find the sector specified in the Command Phase during the execution of a Read, Write, Scan, or Verify command. An address mark was found however, so it is not a blank disk.
2. Controller cannot read any Address Fields without a CRC error during a Read ID command.
3. Controller cannot find starting sector during execution of Read A Track command.

**D1** **Not Writable:** Write Protect pin is active when a Write or Format command is issued.

**D0** **Missing Address Mark:** If bit 0 of ST2 is clear then the controller cannot detect any Address Field Address Mark after two disk revolutions. If bit 0 of ST2 is set then the controller cannot detect the Data Field Address Mark after finding the correct Address Field.

#### 3.10.3 Status Register 2 (ST2)

	D7	D6	D5	D4	D3	D2	D1	D0
<b>DESC</b>	0	CM	CD	WT	SEH	SNS	BT	MD
<b>RESET COND</b>	0	0	0	0	0	0	0	0

**D7** Not Used. Always 0.

**D6** **Control Mark:** Controller tried to read a sector which contained a deleted data address mark during execution of Read Data or Scan commands. Or, if a Read Deleted Data command was executed, a regular address mark was detected.

**D5** **CRC Error in Data Field:** Controller detected a CRC error in the Data Field. Bit 5 of ST1 is also set.

**D4** **Wrong Track:** Only set if desired sector is not found, and the track number recorded on any sector of the current track is different from the track address specified in the Command Phase.

**D3** **Scan Equal Hit:** “Equal” condition satisfied during any Scan command.

**D2** **Scan Not Satisfied:** Controller cannot find a sector on the track which meets the desired condition during any Scan command.

**D1** **Bad Track:** Only set if the desired sector is not found, the track number recorded on any sector on the track is FF (hex) indicating a hard error in IBM format, and is different from the track address specified in the Command Phase.

**D0** **Missing Address Mark in Data Field:** Controller cannot find the Data Field AM during a Read, Scan, or Verify command. Bit 0 of ST1 is also set.

#### 3.10.4 Status Register 3 (ST3)

	D7	D6	D5	D4	D3	D2	D1	D0
<b>DESC</b>	0	WP	1	TK0	1	HDS	DS1	DS0
<b>RESET COND</b>	0	0	1	0	1	0	0	0

**D7** Not Used. Always 0.

**D6** **Write Protect:** Indicates active high status of the WP pin.

**D5** Not Used. Always 1.

**D4** **Track 0:** Indicates active high status of the TRK0 pin.

**D3** Not Used. Always 1.

**D2** **Head Select:** Indicates the active high status of the HD bit in the Command Phase.

**D1–D0** **Drive Select 1,0:** These two binary encoded bits indicate the DS1–DS0 bits in the Command Phase.



## 4.0 Command Set Description

The following is a table of the PC8477B command set. Each command contains a unique first command byte called the opcode byte which will identify to the controller how many command bytes to expect. If an invalid command byte is issued to the controller, it will immediately go into the Result Phase and the status will be 80 (hex), which signifies Invalid Command.

### 4.1 COMMAND SET SUMMARY

#### CONFIGURE

##### Command Phase

0	0	0	1	0	0	1	1
0	0	0	0	0	0	0	0
0	EIS	FIFO	POLL	THRESH			
PRETRK							

**Execution Phase:** Internal registers written.

##### No Result Phase

#### DUMPREG

##### Command Phase

0	0	0	0	1	1	1	0
---	---	---	---	---	---	---	---

**Execution Phase:** Internal registers read.

##### Result Phase

PTR Drive 0							
PTR Drive 1							
PTR Drive 2							
PTR Drive 3							
Step Rate Time				Motor Off Time			
Motor On Time							DMA
Sectors per Track/End of Track							
LOCK	0	DC3	DC2	DC1	DC0	GAP	WG
0	EIS	FIFO	POLL	THRESH			
PRETRK							

**Note:** Sectors per Track parameter returned if last command issued was Format. End of Track parameter returned if last command issued was Read or Write.

#### FORMAT TRACK

##### Command Phase

0	MFM	0	0	1	1	0	1
X	X	X	X	X	HD	DR1	DR0
Bytes per Sector							
Sectors per Track							
Format Gap							
Data Pattern							

**Execution Phase:** System transfers four ID bytes (track, head, sector, bytes/sector) per sector to the floppy controller via DMA or Non-DMA modes. The entire track is formatted. The data block in the Data Field of each sector is filled with the data pattern byte.

##### Result Phase

Status Register 0
Status Register 1
Status Register 2
Undefined
Undefined
Undefined
Undefined

#### INVALID

##### Command Phase

Invalid Op Codes
------------------

##### Result Phase

Status Register 0 (80 hex)
----------------------------

#### LOCK

##### Command Phase

LOCK	0	0	1	0	1	0	0
------	---	---	---	---	---	---	---

**Execution Phase:** Internal register is written.

##### Result Phase

0	0	0	LOCK	0	0	0	0
---	---	---	------	---	---	---	---

#### MODE

##### Command Phase

0	0	0	0	0	0	0	1
TMR	IAF	IPS	0	LOW PWR	1	ETR	
FWR	FRD	BST	R255	0	0	0	0
DENSEL	BFR	WLD	Head Settle				
0	0	0	0	0	RG	O	PU

**Execution Phase:** Internal registers are written.

##### No Result Phase

#### NSC

##### Command Phase

0	0	0	1	1	0	0	0
---	---	---	---	---	---	---	---

##### Result Phase

0	1	1	1	0	0	1	1
---	---	---	---	---	---	---	---

#### PERPENDICULAR MODE

##### Command Phase

0	0	0	1	0	0	1	0
OW	0	DC3	DC2	DC1	DC0	GAP	WG

**Execution Phase:** Internal registers are written.

##### No Result Phase

## 4.0 Command Set Description (Continued)

### READ DATA

#### Command Phase

MT	MFM	SK	0	0	1	1	0
IPS	X	X	X	X	HD	DR1	DR0
Track Number							
Drive Head Number							
Sector Number							
Bytes per Sector							
End of Track Sector Number							
Intersector Gap Length							
Data Length							

**Execution Phase:** Data read from disk drive is transferred to system via DMA or Non-DMA modes.

#### Result Phase

Status Register 0
Status Register 1
Status Register 2
Track Number
Head Number
Sector Number
Bytes per Sector

### READ DELETED DATA

#### Command Phase

MT	MFM	SK	0	1	1	0	0
IPS	X	X	X	X	HD	DR1	DR0
Track Number							
Drive Head Number							
Sector Number							
Bytes per Sector							
End of Track Sector Number							
Intersector Gap Length							
Data Length							

**Execution Phase:** Data read from disk drive is transferred to system via DMA or Non-DMA modes.

#### Result Phase

Status Register 0
Status Register 1
Status Register 2
Track Number
Head Number
Sector Number
Bytes per Sector

### READ ID

#### Command Phase

0	MFM	0	0	1	0	1	0
X	X	X	X	X	HD	DR1	DR0

**Execution Phase:** Controller reads first ID Field header bytes it can find and reports these bytes to the system in the result bytes.

#### Result Phase

Status Register 0
Status Register 1
Status Register 2
Track Number
Head Number
Sector Number
Bytes per Sector

### READ A TRACK

#### Command Phase

0	MFM	0	0	0	0	1	0
IPS	X	X	X	X	HD	DR1	DR0
Track Number							
Drive Head Number							
Sector Number							
Bytes per Sector							
End of Track Sector Number							
Intersector Gap Length							
Data Length							

**Execution Phase:** Data read from disk drive is transferred to system via DMA or Non-DMA modes.

#### Result Phase

Status Register 0
Status Register 1
Status Register 2
Track Number
Head Number
Sector Number
Bytes per Sector

### RECALIBRATE

#### Command Phase

0	0	0	0	0	1	1	1
0	0	0	0	0	0	DR1	DR0

**Execution Phase:** Disk drive head is stepped out to Track 0.

#### No Result Phase

### RELATIVE SEEK

#### Command Phase

1	DIR	0	0	1	1	1	1
X	X	X	X	X	HD	DR1	DR0
Relative Track Number							

**Execution Phase:** Disk drive head stepped in or out a programmable number of tracks.

#### No Result Phase



## 4.0 Command Set Description (Continued)

### SCAN EQUAL Command Phase

MT	MFM	SK	1	0	0	0	1
IPS	X	X	X	X	HD	DR1	DR0
Track Number							
Drive Head Number							
Sector Number							
Bytes per Sector							
End of Track Sector Number							
Intersector Gap Length							
Sector Step Size							

**Execution Phase:** Data transferred from system to controller is compared to data read from disk.

### Result Phase

Status Register 0
Status Register 1
Status Register 2
Track Number
Head Number
Sector Number
Bytes per Sector

### SCAN HIGH OR EQUAL Command Phase

MT	MFM	SK	1	1	1	0	1
IPS	X	X	X	X	HD	DR1	DR0
Track Number							
Drive Head Number							
Sector Number							
Bytes per Sector							
End of Track Sector Number							
Intersector Gap Length							
Sector Step Size							

**Execution Phase:** Data transferred from system to controller is compared to data read from disk.

### Result Phase

Status Register 0
Status Register 1
Status Register 2
Track Number
Head Number
Sector Number
Bytes per Sector

### SCAN LOW OR EQUAL Command Phase

MT	MFM	SK	1	1	0	0	1
IPS	X	X	X	X	HD	DR1	DR0
Track Number							
Drive Head Number							
Sector Number							
Bytes per Sector							
End of Track Sector Number							
Intersector Gap Length							
Sector Step Size							

**Execution Phase:** Data transferred from system to controller is compared to data read from disk.

### Result Phase

Status Register 0
Status Register 1
Status Register 2
Track Number
Head Number
Sector Number
Bytes per Sector

### SEEK Command Phase

0	0	0	0	1	1	1	1
X	X	X	X	X	HD	DR1	DR0
New Track Number							
MSN of Track Number				0	0	0	0

**Note:** Last Command Phase byte is required only if ETR is set in Mode Command.

**Execution Phase:** Disk drive head is stepped in or out to a programmable track.

### No Result Phase

### SENSE DRIVE STATUS Command Phase

0	0	0	0	0	1	0	0
X	X	X	X	X	HD	DR1	DR0

**Execution Phase:** Disk drive status information is detected and reported.

### Result Phase

Status Register 3
-------------------

### SENSE INTERRUPT Command Phase

0	0	0	0	1	0	0	0
---	---	---	---	---	---	---	---

**Execution Phase:** Status of interrupt is reported.

### Result Phase

Status Register 0							
Present Track Number (PTR)							
MSN of PTR				0	0	0	0

**Note:** Third Result Phase byte can only be read if ETR is set in the Mode Command.

## 4.0 Command Set Description (Continued)

### SET TRACK

#### Command Phase

0	WNR	1	0	0	0	0	1
0	0	1	1	0	MSB	DR1	DR0
New Track Number (PTR)							

**Execution Phase:** Internal register is read or written.

#### Result Phase

Value
-------

### SPECIFY

#### Command Phase

0	0	0	0	0	0	1	1
Step Rate Time				Motor Off Time			
Motor On Time						DMA	

**Execution Phase:** Internal registers are written.

#### No Result Phase

### VERIFY

#### Command Phase

MT	MFM	SK	1	0	1	1	0
EC	X	X	X	X	HD	DR1	DR0
Track Number							
Drive Head Number							
Sector Number							
Bytes per Sector							
End of Track Sector Number							
Intersector Gap Length							
Data Length/Sector Count							

**Execution Phase:** Data is read from disk but not transferred to the system.

#### Result Phase

Status Register 0
Status Register 1
Status Register 2
Track Number
Head Number
Sector Number
Bytes per Sector

### VERSION

#### Command Phase

0	0	0	1	0	0	0	0
---	---	---	---	---	---	---	---

#### Result Phase

1	0	0	1	0	0	0	0
---	---	---	---	---	---	---	---

### WRITE DATA

#### Command Phase

MT	MFM	0	0	0	1	0	1
IPS	X	X	X	X	HD	DR1	DR0
Track Number							
Drive Head Number							
Sector Number							
Bytes per Sector							
End of Track Sector Number							
Intersector Gap Length							
Data Length							

**Execution Phase:** Data is transferred from the system to the controller via DMA or Non-DMA modes and written to the disk.

#### Result Phase

Status Register 0
Status Register 1
Status Register 2
Track Number
Head Number
Sector Number
Bytes per Sector

### WRITE DELETED DATA

#### Command Phase

MT	MFM	0	0	1	0	0	1
IPS	X	X	X	X	HD	DR1	DR0
Track Number							
Drive Head Number							
Sector Number							
Bytes per Sector							
End of Track Sector Number							
Intersector Gap Length							
Data Length							

**Execution Phase:** Data is transferred from the system to the controller via DMA or Non-DMA modes and written to the disk.

#### Result Phase

Status Register 0
Status Register 1
Status Register 2
Track Number
Head Number
Sector Number
Bytes per Sector

## 4.0 Command Set Description (Continued)

### 4.2 COMMAND DESCRIPTION

#### 4.2.1 Configure Command

The Configure Command will control some operation modes of the controller. It should be issued during the initialization of the PC8477B after power up. The function of the bits in the Configure registers is described below. These bits are set to their default values after a hardware reset. The value of each bit after a software reset is explained. The default value of each bit is denoted by a "bullet" to the left of each item.

**EIS:** Enable Implied Seeks. Default after a software reset.

- 0 = Implied seeks disabled through Configure command. Implied seeks can still be enabled through the Mode command when EIS = 0. (default)
- 1 = Implied seeks enabled for a read, write, scan, or verify operation. A seek and sense interrupt operation will be performed prior to the execution of the read, write, scan, or verify operation. The IPS bit does not need to be set.

**FIFO:** Enable FIFO for Execution Phase data transfers. Default after a software reset if the LOCK bit is 0. If the LOCK bit is 1, then the FIFO bit will retain its previous value after a software reset.

- 0 = FIFO enabled for both reads and writes.
- 1 = FIFO disabled. (default)

**POLL:** Disable for Drive Polling Mode. Default after a software reset.

- 0 = Enable polling mode. An interrupt is generated after a reset. (default)
- 1 = Disable drive polling mode. If the Configure command is issued within 500  $\mu$ s of a hardware or software reset, then an interrupt will not be generated. In addition, the four Sense Interrupt commands to clear the "Ready Changed State" of the four logical drives will not be required.

**THRESH:** The FIFO threshold in the Execution Phase of read and write data transfers. Programmable from 00 to 0F hex. Defaults to 00 after a software reset if the LOCK bit is 0. If the LOCK bit is 1, then THRESH will retain its value. A high value of THRESH is suited for slow response systems, and a low value of THRESH is better for fast response systems.

**PRETRK:** Starting track number for write precompensation. Programmable from track 0 ("00") to track 255 ("FF"). Defaults to track 0 ("00") after a software reset if the LOCK bit is 0. If the LOCK bit is 1, then PRETRK will retain its value.

#### 4.2.2 Dumpreg Command

The Dumpreg command is designed to support system runtime diagnostics and application software development and debug. This command has a one byte command phase and a ten byte result phase, which return the values of parameters set in other commands. That is, the PTR (Present Track Register) contains the least significant byte of the track the microcode has stored for each drive. The Step Rate Time, Motor Off and Motor On Times, and the DMA bit are all set in the Specify command.

The sixth byte of the result phase varies depending on which commands have been previously executed. If a format command has previously been issued, and no reads or writes have been issued since then, then this byte will contain the Sectors per track value. If a read or a write command has been executed more recently than a format command, this byte will contain the End of Track value. The LOCK bit is set in the Lock command. The eighth result byte also contains the bits programmed in the Perpendicular Mode command. The last two bytes of the Dumpreg Result Phase are set in the Configure command. After a hardware or software reset, the parameters in the result bytes will be set to their appropriate default values.

**Note:** Some of these parameters are unaffected by a software reset, depending on the state of the LOCK bit.

#### 4.2.3 Format Track Command

This command will format one track on the disk in IBM, ISO, or Perpendicular Format. After the index hole is detected, data patterns are written on the disk including all Gaps, Address Marks, Address Fields, and Data Fields. The exact format is determined by the following parameters:

1. The MFM bit in the Opcode (first command) byte, which determines the format of the Address Marks and the encoding scheme.
2. The IAF bit in the Mode command, which selects between IBM and ISO format.
3. The WGATE and GAP bits in the Perpendicular Mode command, which select between the conventional and Toshiba Perpendicular format.
4. The Bytes per Sector code, which determines the sector size.
5. The Sectors per Track parameter, which determines how many sectors will be formatted on the track.
6. The Data Pattern byte, which is used as the filler byte in the Data Field of each sector.

To allow for flexible formatting, the  $\mu$ P must supply the four Address Field bytes (track, head, sector, bytes per sector code) for each sector formatted during the Execution Phase. This allows for non-sequential sector interleaving. This transfer of bytes from the  $\mu$ P to the controller can be done in the DMA or Non-DMA mode, with the FIFO enabled or disabled.

## 4.0 Command Set Description (Continued)

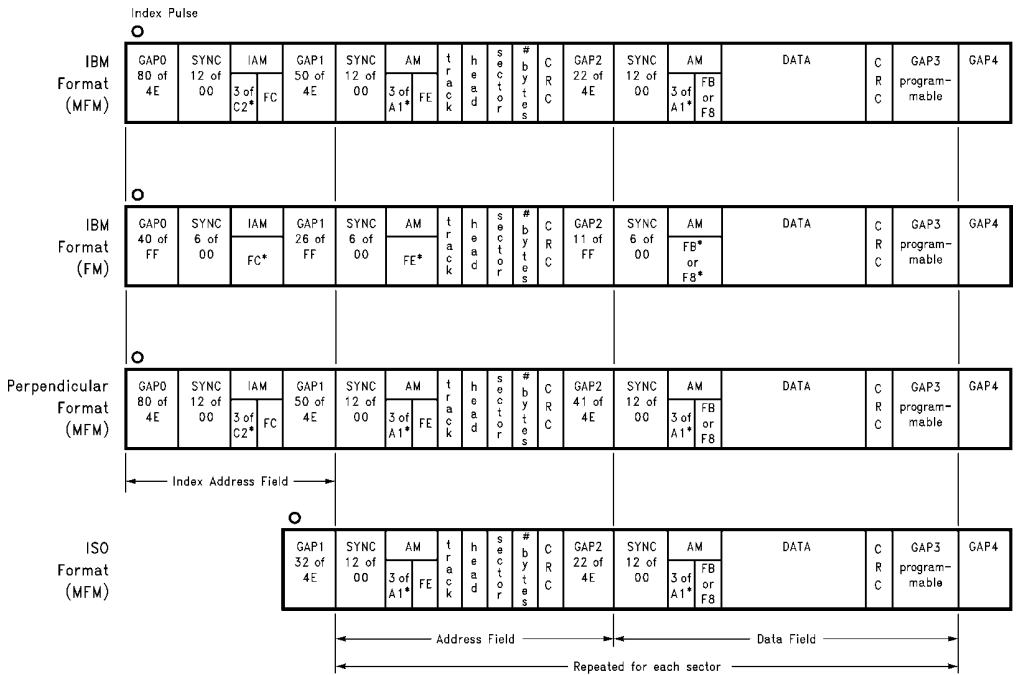

TL/F/11332-4

### Notes:

- FE\* = Data Pattern of FE, Clock Pattern of C7
- FC\* = Data Pattern of FC, Clock Pattern of D7
- FB\* = Data Pattern of FB, Clock Pattern of C7
- F8\* = Data Pattern of F8, Clock Pattern of C7
- A1\* = Data Pattern of A1, Clock Pattern of 0A
- C2\* = Data Pattern of C2, Clock Pattern of 14
- All byte counts in decimal
- All byte values in hex
- Two byte CRC uses standard polynomial  $x^{16} + x^{12} + x^5 + 1$
- FM mode is not guaranteed through functional testing.
- Perpendicular Format GAP2 = 41 bytes for 1 Mb/s
- All other data rates use GAP2 = 22 bytes

**FIGURE 4-1. IBM, Perpendicular, and ISO Formats Supported by Format Command**

## 4.0 Command Set Description (Continued)

The Format command terminates when the index hole is detected a second time, at which point an interrupt is generated. Only the first three status bytes in the Result Phase are significant. The Format Gap byte in the Command Phase is dependent on the data rate and type of disk drive, and will control the length of GAP3. Some typical values for the programmable GAP3 are given in Table 4-1 below. *Figure 4-1* shows the track format for the different formats recognized by the Format Command.

### 4.2.4 Invalid Command

If an invalid command (illegal Opcode byte in the Command Phase) is received by the controller, the controller will respond with ST0 in the Result Phase. The controller does not generate an interrupt during this condition. Bits 6 and 7 in the MSR are both set to a 1, indicating to the  $\mu$ P that the controller is in the Result Phase and the contents of ST0 must be read. The system will read an 80 (hex) value from ST0 indicating an invalid command was received.

**TABLE 4-1. Typical Format Gap Length Values**

Mode	Sector Size	Sector Code	EOT	Sector Gap	Format GAP3
	Decimal	Hex	Hex	Hex	Hex
125 kb/s FM	128	00	12	07	09
	128	00	10	10	19
	256	01	08	18	30
	512	02	04	46	87
	1024	03	02	C8	FF
	2048	04	01	C8	FF
250 kb/s MFM	256	01	12	0A	0C
	256	01	10	20	32
	512	02	08	2A	50
	512	02	09	2A	50
	1024	03	04	80	F0
	2048	04	02	C8	FF
	4096	05	01	C8	FF
250 kb/s FM	128	00	1A	07	1B
	256	01	0F	0E	2A
	512	02	08	1B	3A
	1024	03	04	47	8A
	2048	04	02	C8	FF
	4096	05	01	C8	FF
500 kb/s MFM	256	01	1A	0E	36
	512	02	0F	1B	54
	512	02	12	1B	6C
	1024	03	08	35	74
	2048	04	04	99	FF
	4096	05	02	C8	FF
	8192	06	01	C8	FF

**Note:** FM mode is not guaranteed through functional testing.

**Typical Values for PC Compatible Diskette Media**

Media Type	Sector Size	Sector Code	EOT	Sector Gap	Format GAP
	Decimal	Hex	Hex	Hex	Hex
360K	512	02	09	2A	50
1.2M	512	02	0F	1B	54
720K	512	02	09	1B	50
1.44M	512	02	12	1B	6C
2.88M	512	02	24	1B	53

**Notes:**

Sector Gap refers to the Intersector Gap Length parameter specified in the Command Phase of the Read, Write, Scan, and Verify commands. Although this is the recommended value, the PC8477B treats this byte as a don't care in the Read, Write, Scan, and Verify commands.

Format Gap is the suggested value to use in the Format Gap parameter of the Format command. This is the programmable GAP3 as shown in *Figure 4-1*.

The 2.88M diskette media is a new Barium Ferrite media intended for use in Perpendicular Recording drives at the data rate of up to 1 Mb/s.

## 4.0 Command Set Description (Continued)

### 4.2.5 Lock Command

The Lock command allows the user full control of the FIFO parameters after a software reset. If the LOCK bit is set to 1, then the FIFO, THRESH, and PRETRK bits in the Configure command are not affected by a software reset. In addition, the FWR, FRD, and BST bits in the Mode command will be unaffected by a software reset. If the LOCK is 0 (default after a hardware reset), then the above bits will be set to their default values after a software reset. This command is useful if the system designer wishes to keep the FIFO enabled and retain the other FIFO parameter values (such as THRESH) after a software reset.

After the command byte is written, the result byte must be read before continuing to the next command. The execution of the Lock command is not performed until the result byte is read by the  $\mu$ P. If the part is reset after the command byte is written but before the result byte is read, then the Lock command execution will not be performed. This is done to prevent accidental execution of the Lock command.

### 4.2.6 Mode Command

This command is used to select the special features of the controller. The bits for the Command Phase bytes are shown in Section 4.1 Command Set Summary, and their function is described below. These bits are set to their default values after a hardware reset. The default value of each bit is denoted by a “bullet” to the left of each item. The value of each parameter after a software reset will be explained.

**TMR:** Motor Timer mode. Default after a software reset.

- 0 = Timers for motor on and motor off are defined for Mode 1. (See Specify command.) (default)
- 1 = Timers for motor on and motor off are defined for Mode 2. (See Specify command.)

**IAF:** Index Address Format. Default after a software reset.

- 0 = The controller will format tracks with the Index Address Field included. (IBM and Perpendicular format.)
- 1 = The controller will format tracks without including the Index Address Field. (ISO format.)

**IPS:** Implied Seek. Default after a software reset.

- 0 = The implied seek bit in the command byte of a read, write or scan is ignored. Implied seeks could still be enabled by the EIS bit in the Configure command.
- 1 = The IPS bit in the command byte of a read, write or scan is enabled so that if it is set, the controller will perform seek and sense interrupt operations before executing the command.

**LOW PWR:** Low Power mode. Default after a software reset.

- 00 = Completely disable the low power mode. (default)
- 01 = Automatic low power. Go into low power mode 512 ms after the head unload timer times out. This is based on 500 kb/s or 1 Mb/s data rate. Double this value for 250 kb/s.
- 10 = Manual low power. Go into low power mode now.
- 11 = Not used.

**ETR:** Extended Track Range. Default after a software reset.

- 0 = Track number is stored as a standard 8-bit value compatible with the IBM, ISO, and Perpendicular formats. This will allow access to up to 256 tracks during a seek operation.
- 1 = Track number is stored as a 12-bit value. The upper four bits of the track value are stored in the upper four bits of the head number in the sector Address Field. This allows access to up to 4096 tracks during a seek operation. With this bit set, an extra byte is required in the Seek Command Phase and Sense Interrupt Result Phase.

**FWR:** FIFO Write Disable for  $\mu$ P write transfers to controller. Default after a software reset if LOCK is 0. If LOCK is 1, FWR will retain its value after a software reset.

**Note:** This bit is only valid if the FIFO is enabled in the Configure command. If the FIFO is not enabled in the Configure command, then this bit is a don't care.

- 0 = Enable FIFO. Execution Phase  $\mu$ P write transfers use the internal FIFO. (default)
- 1 = Disable FIFO. All write data transfers take place without the FIFO.

**FRD:** FIFO Read Disable for  $\mu$ P read transfer from controller. Default after a software reset if LOCK is 0. If LOCK is 1, FRD will retain its value after a software reset.

**Note:** This bit is only valid if the FIFO is enabled in the Configure command. If the FIFO is not enabled in the Configure command, then this bit is a don't care.

- 0 = Enable FIFO. Execution Phase  $\mu$ P read transfer use the internal FIFO. (default)
- 1 = Disable FIFO. All read data transfers take place without the FIFO.

**BST:** Burst Mode Disable. Default after a software reset if LOCK is 0. If LOCK is 1, BST will retain its value after a software reset.

**Note:** This bit is only valid if the FIFO is enabled in the Configure command. If the FIFO is not enabled in the Configure command, then this bit is a don't care.

- 0 = Burst mode enabled for FIFO Execution Phase data transfers. (default)
- 1 = Non-Burst mode enabled. The DRQ or INT pin will be strobed once for each byte to be transferred while the FIFO is enabled.

**R255:** Recalibrate Step Pulses. The bit will determine the maximum number of recalibrate step pulses the controller will issue before terminating with an error. Default after a software reset.

- 0 = 85 maximum recalibrate step pulses. If ETR = 1, controller will issue 3925 recalibrate step pulses maximum.
- 1 = 255 maximum recalibrate step pulses. If ETR = 1, controller will issue 4095 maximum recalibrate step pulses.

**DENSEL:** Density Select Pin Configuration. This two bit value will configure the Density Select output to one of three possible modes. The default mode will configure the DENSEL pin according to the state of the IDENT input pin after a data rate has been selected. That is, if IDENT is high, the DENSEL pin is active high for the 500 kb/s or 1 Mb/s data rates.

## 4.0 Command Set Description (Continued)

If IDENT is low, the DENSEL pin is active low for the 500 kb/s or 1 Mb/s data rates. In addition to these modes, the DENSEL output can be set to always low or always high, as shown in Table 4-2. This will allow the user more flexibility with new drive types.

**Note:** The DENSEL output values shown below are with the  $\overline{\text{INVERT}}$  pin tied low. If the  $\overline{\text{INVERT}}$  pin is tied high, the outputs shown below have the opposite polarity.

**TABLE 4-2. DENSEL Decoding**

Bit 1	Bit 0	DENSEL Pin Definition
0	0	low
0	1	high
1	0	undefined
1	1	DEFAULT

**TABLE 4-3. DENSEL Default Encoding**

Data Rate	DENSEL (default)	
	IDENT = 1	IDENT = 0
250 kb/s	low	high
300 kb/s	low	high
500 kb/s	high	low
1 Mb/s	high	low

**BFR:** CMOS Disk Interface Buffer Enable.

- 0 = Drive output signals configured as standard 4 mA push-pull outputs (actually 48 mA sink, 4 mA source). (default)
- 1 = Drive output signals configured as 48 mA open-drain outputs.

**WLD:** Scan Wild Card.

- 0 = An FF (hex) from either the  $\mu\text{P}$  or the disk during a Scan command is interpreted as a wildcard character that will always match true. (default)
- 1 = The Scan commands do not recognize FF (hex) as a wildcard character.

**Head Settle:** Time allowed for read/write head to settle after a seek during an Implied Seek operation.

Data Rate	HST	Range
250 kb/s	N x 8	0–120 ms
300 kb/s	N x 6.67	0–100 ms
500 kb/s	N x 4	0–60 ms
1 Mb/s	N x 2	0–30 ms

**Note:** N = 8 (default) HST = Head Settle Time

**RG:** Read Gate Diagnostic.

- 0 = Enable DSKCHG disk interface input for normal operation. (default)
- 1 = Enable DSKCHG to act as an external Read Gate input signal to the Data Separator. This is intended as a test mode to aid in evaluation of the Data Separator.

**PU:** PUMP Pulse Output Diagnostic.

- 0 = Enable MFM output pin for normal operation. (default)

- 1 = Enable the MFM output to act as the active low output of the Data Separator charge pump. This signal consists of a series of pulses indicating when the phase comparator is making a phase correction. This Pump output will be active low for a pump up or pump down signal from the phase comparator, and is intended as a test mode to aid in the evaluation of the Data Separator.

### 4.2.7 NSC Command

The NSC command can be used to distinguish between the PC8477B version and the Intel 82077AA. The result Phase byte uniquely identifies the floppy controller as a PC8477B, which returns a value of 73 hex. The 82077AA and DP8473 return a value 80h signifying an invalid command. The lower four bits of this result byte are subject to change by NSC, and will reflect the particular version of the PC8477B part.

**Note:** The PC8477A will return a value of 72h in the result phase of the NSC command.

### 4.2.8 Perpendicular Mode Command

The Perpendicular Mode command is designed to support the unique Format and Write Data requirements of Perpendicular (Vertical) Recording disk drives (4 Mbytes unformatted capacity). The Perpendicular Mode command will configure each of the four logical drives as a perpendicular or conventional disk drive. Configuration of the four logical disk drives is done via the D3–D0 bits, or with the GAP and WG control bits. This command should be issued during the initialization of the floppy controller.

Perpendicular Recording drives operate in “Extra High Density” mode at 1 Mb/s, and are downward compatible with 1.44 Mbyte and 720 kbyte drives at 500 kb/s (High Density) and 250 kb/s (Double Density) respectively. If perpendicular drives are present in the system, this command should be issued during initialization of the floppy controller, which will configure each drive as perpendicular or conventional. Then, when a drive is accessed for a Format or Write Data command, the floppy controller will adjust the Format or Write Data parameters based on the data rate (see Table 4-4).

Looking at the second command byte, DC3–DC0 correspond to the four logical drives. A “0” written to DCn sets drive n to conventional mode, and a “1” sets drive n to perpendicular mode. Also, the OW (Overwrite) bit offers additional control. When OW = 1, changing the values of DC3–DC0 (drive configuration bits) is enabled. When OW = 0, the internal values of DC3–DC0 are unaffected, regardless of what is written to DC3–DC0.

The function of the DCn bits must also be qualified by setting both WG and GAP to 0. If WG and GAP are used (i.e., not set to 00), they will override whatever is programmed in the DCn bits. Table 4-4A indicates the operation of the PC8477B based on the values of GAP and WG. Note that when GAP and WG are both 0, the DCn bits are used to configure each logical drive as conventional or perpendicular. DC3–DC0 are unaffected by a software reset, but WG and GAP are both cleared to 0 after a software reset. A hardware reset will reset all the bits to zero (conventional mode for all drives). The Perpendicular Mode command bits may be rewritten at any time.

**Note:** When in the Perpendicular Mode for any drive at any data rate via the DC3–DC0 bits, write precompensation is set to zero.

## 4.0 Command Set Description (Continued)

**TABLE 4-4. Effect of Drive Mode and Data Rate on Format and Write Commands**

Data Rate	Drive Mode	GAP2 Length Written During Format	Portion of GAP2 Re-Written by Write Data Command
250/300/500 kb/s	Conventional	22 bytes	0 bytes
	Perpendicular	22 bytes	19 bytes
1 Mb/s	Conventional	22 bytes	0 bytes
	Perpendicular	41 bytes	38 bytes

**TABLE 4-4A. Effect of GAP and WG on Format and Write Commands**

GAP	WG	Mode Description	GAP2 Length Written During Format	Portion of GAP2 Re-Written by Write Data Command
0	0	Conventional	22 bytes	0 bytes
0	1	Perpendicular ( $\leq 500$ kb/s)	22 bytes	19 bytes
1	0	Reserved (Conventional)	22 bytes	0 bytes
1	1	Perpendicular (1 Mb/s)	41 bytes	38 bytes

Perpendicular Recording type disk drives have a Pre-Erase Head which leads the Read/Write Head by 200  $\mu\text{m}$ , which translates to 38 bytes at the 1 Mb/s data transfer rate (19 bytes at 500 kb/s). The increased spacing between the two heads requires a larger GAP2 between the Address Field and Data Field of a sector at 1 Mb/s. (See Perpendicular Format in Table 4-1.) This GAP2 length of 41 bytes (at 1 Mb/s) will ensure that the Preamble in the Data Field is completely “pre-erased” by the Pre-Erase Head. Also, during Write Data operations to a perpendicular drive, a portion of GAP2 must be rewritten by the controller to guarantee that the Data Field Preamble has been pre-erased (see Table 4-4).

### 4.2.9 Read Data Command

The Read Data command reads logical sectors containing a Normal Data AM from the selected drive and makes the data available to the host  $\mu\text{P}$ . After the last Command Phase byte is written, the controller will simulate the Motor On Time for the selected drive internally. The user must turn on the drive motor directly by enabling the appropriate drive and motor select disk interface outputs with the Digital Output Register (DOR).

If Implied Seeks are enabled, the controller will perform a Seek operation to the track number specified in the Command Phase. The controller will also issue a Sense Interrupt for the seek and wait the Head Settle time specified in the Mode command.

The correct ID information (track, head, sector, bytes per sector) for the desired sector must be specified in the command bytes. See Table 4-5 Sector Size Selection for details on the bytes per sector code. In addition, the End of Track Sector Number (EOT) should be specified, allowing the controller to read multiple sectors. The Data Length byte is a don't care and should be set to FF (hex).

**TABLE 4-5. Sector Size Selection**

Bytes per Sector Code	Number of Bytes in Data Field
0	128
1	256
2	512
3	1024
4	2048
5	4096
6	8192
7	16384

The controller then starts the Data Separator and waits for the Data Separator to find the next sector Address Field. The controller compares the Address Field ID information (track, head, sector, bytes per sector) with the desired ID specified in the Command Phase. If the sector ID bytes do not match, then the controller waits for the Data Separator to find the next sector Address Field. The ID comparison process repeats until the Data Separator finds a sector Address Field ID that matches that in the command bytes, or until an error occurs. Possible errors are:

1. The  $\mu\text{P}$  aborted the command by writing to the FIFO. If there is no disk in the drive, the controller will hang up. The  $\mu\text{P}$  must then take the controller out of this hung state by writing a byte to the FIFO. This will put the controller into the Result Phase.
2. Two index pulses were detected since the search began, and no valid ID has been found. If the track address ID differs, the WT bit or BT bit (if the track address is FF hex) will be set in ST2. If the head, sector, or bytes per sector code did not match, the ND bit is set in ST1. If the Address Field AM was never found, the MA bit is set in ST1.
3. The Address Field was found with a CRC error. The CE bit is set in ST1.



## 4.0 Command Set Description (Continued)

Once the desired sector Address Field is found, the controller waits for the Data Separator to find the subsequent Data Field for that sector. If the Data Field (normal or deleted) is not found with the expected time, the controller terminates the operation and enters the Result Phase (MD is set in ST2). If a Deleted Data Mark is found and SK was set in the Opcode command byte, the controller skips this sector and searches for the next sector Address Field as described above. The effect of SK on the Read Data command is summarized in Table 4-6.

Having found the Data Field, the controller then transfers data bytes from the disk drive to the host (described in Section 5.3 Controller Phases) until the bytes per sector count has been reached, or the host terminates the operation (through TC, end of track, or implicitly through overrun). The controller will then generate the CRC for the sector and compare this value with the CRC at the end of the Data Field.

Having finished reading the sector, the controller will continue reading the next logical sector unless one or more of the following termination conditions occurred:

1. The DMA controller asserted TC. The IC bits in ST0 are set to Normal Termination.
2. The last sector address (of side 1 if MT was set) was equal to EOT. The EOT bit in ST1 is set. The IC bits in ST0 are set to Abnormal Termination. This is the expected condition during Non-DMA transfers.

3. Overrun error. The OR bit in ST1 is set. The IC bits in ST0 are set to Abnormal Termination. If the  $\mu$ P cannot service a transfer request in time, the last correctly read byte will be transferred.

4. CRC error. The CE bit in ST1 and CD bit in ST2 are set. The IC bits in ST0 are set to Abnormal Termination.

If MT was set in the Opcode command byte, and the last sector of side 0 has been transferred, the controller will then continue with side 1, starting with sector 1 and continuing until EOT sector number is reached or TC occurs.

Upon terminating the Execution Phase of the Read Data command, the controller will assert INT, indicating the beginning of the Result Phase. The  $\mu$ P must then read the result bytes from the FIFO. The values that will be read back in the result bytes are shown in Table 4-7. If an error occurs, the result bytes will indicate the sector read when the error occurred.

### 4.2.10 Read Deleted Data Command

The Read Deleted Data command reads logical sectors containing a Deleted Data AM from the selected drive and makes the data available to the host  $\mu$ P. This command is identical to the Read Data command, except for the setting of the CM bit in ST2 and the skipping of sectors. The effect of SK on the Read Deleted Data command is summarized in Table 4-8. See Table 4-7 for the state of the result bytes for a Normal Termination of the command.

TABLE 4-6. SK Effect on Read Data Command

SK	Data Type	Sector Read?	CM Bit (ST2)	Description of Results
0	Normal	Y	0	Normal Termination
0	Deleted	Y	1	No Further Sectors Read
1	Normal	Y	0	Normal Termination
1	Deleted	N	1	Sector Skipped

TABLE 4-7. Result Phase Termination Values with No Error

MT	HD	Last Sector	ID Information at Result Phase			
			Track	Head	Sector	Bytes/Sector
0	0	< EOT	NC	NC	S + 1	NC
0	0	= EOT	T + 1	NC	1	NC
0	1	< EOT	NC	NC	S + 1	NC
0	1	= EOT	T + 1	NC	1	NC
1	0	< EOT	NC	H	S + 1	NC
1	0	= EOT	T + 1	0	1	NC
1	1	< EOT	NC	H	S + 1	NC
1	1	= EOT	T + 1	0	1	NC

EOT = End of Track Sector Number from Command Phase  
 NC = No Change in Value  
 S = Sector Number last operated on by controller

T = Track Number programmed in Command Phase  
 H = Head last selected by controller

TABLE 4-8. SK Effect on Read Deleted Data Command

SK	Data Type	Sector Read?	CM Bit (ST2)	Description of Results
0	Normal	Y	1	No Further Sectors Read
0	Deleted	Y	0	Normal Termination
1	Normal	N	1	Sector Skipped
1	Deleted	Y	0	Normal Termination

## 4.0 Command Set Description (Continued)

### 4.2.11 Read ID Command

The Read ID command finds the next available Address Field and returns the ID bytes (track, head, sector, bytes per sector) to the  $\mu$ P in the Result Phase. There is no data transfer during the Execution Phase of this command. An interrupt will be generated when the Execution Phase is completed.

The controller first simulates the Motor On time for the selected drive internally. The user must turn on the drive motor directly by enabling the appropriate drive and motor select disk interface outputs with the Digital Output Register (DOR). The Read ID command does not perform an implied seek.

After waiting the Motor On time, the controller starts the Data Separator and waits for the Data Separator to find the next sector Address Field. If an error condition occurs, the IC bits in ST0 are set to Abnormal Termination, and the controller enters the Result Phase. Possible errors are:

1. The  $\mu$ P aborted the command by writing to the FIFO. If there is no disk in the drive, the controller will hang up. The  $\mu$ P must then take the controller out of this hung state by writing a byte to the FIFO. This will put the controller into the Result Phase.
2. Two index pulses were detected since the search began, and no AM has been found. If the Address Field AM was never found, the MA bit is set in ST1.

### 4.2.12 Read A Track Command

The Read a Track command reads sectors in physical order from the selected drive and makes the data available to the host. This command is similar to the Read Data command except for the following differences:

1. The controller waits for the index pulse before searching for a sector Address Field. If the  $\mu$ P writes to the FIFO before the index pulse, the command will enter the Result Phase with the IC bits in ST0 set to Abnormal Termination.
2. A comparison of the sector Address Field ID bytes will be performed, except for the sector number. The internal sector address is set to 1, and then incremented for each successive sector read.
3. If the Address Field ID comparison fails, the controller sets ND in ST1, but continues to read the sector. If there is a CRC error in the Address Field, the controller sets CE in ST1, but continues to read the sector.
4. Multi-track and Skip operations are not allowed. SK and MT should be set to 0.
5. If there is a CRC error in the Data Field, the controller sets CE in ST1 and CD in ST2, but continues reading sectors.
6. The controller reads a maximum of EOT physical sectors. There is no support for multi-track reads.

### 4.2.13 Recalibrate Command

The Recalibrate command is very similar to the Seek command. The controller sets the Present Track Register (PTR) of the selected drive to zero. It then steps the head of the selected drive out until the TRK0 disk interface input signal goes active, or until the maximum number of step pulses have been issued. See Table 4-9 for the maximum recalibrate

step pulse values based on the R255 and ETR bits in the Mode command. If the number of tracks on the disk drive exceeds the maximum number of recalibrate step pulses, another Recalibrate command may need to be issued.

TABLE 4-9. Maximum Recalibrate Step Pulses Based on R255 and ETR

R255	ETR	Maximum Recalibrate Step Pulses
0	0	85 (default)
1	0	255
0	1	3925
1	1	4095

After the last command byte is issued, the DRx BUSY bit is set in the MSR for the selected drive. The controller will simulate the Motor On time, and then enter the Idle Phase. The execution of the actual step pulses occurs while the controller is in the Drive Polling Phase. An interrupt will be generated after the TRK0 signal is asserted, or after the maximum number of recalibrate step pulses are issued. There is no Result Phase. Recalibrates on more than one drive at a time should not be issued for the same reason as explained in the Seek command. No other command except the Sense Interrupt command should be issued while a Recalibrate command is in progress.

### 4.2.14 Relative Seek Command

The Relative Seek command steps the selected drive in or out a given number of steps. This command will step the read/write head an incremental number of tracks, as opposed to comparing against the internal present track register for that drive. The Relative Seek parameters are defined as follows:

**DIR:** Read/Write Head Step Direction Control

0 = Step Head Out

1 = Step Head In

**RTN:** Relative Track Number. This value will determine how many incremental tracks to step the head in or out from the current track number.

The controller will issue RTN number of step pulses and update the Present Track Register for the selected drive. The one exception to this is if the TRK0 disk input goes active, which indicates that the drive read/write head is at the outermost track. In this case, the step pulses for the Relative Seek are terminated, and the PTR value is set according to the actual number of step pulses issued. The arithmetic is done modulo 255. The DRx BUSY bit in the MSR is set for the selected drive. The controller will simulate the Motor On time before issuing the step pulses. After the Motor On time, the controller will enter the Idle Phase. The execution of the actual step pulses occurs in the Idle Phase of the controller.

After the step operation is complete, the controller will generate an interrupt. There is no Result Phase. Relative Seeks on more than one drive at a time should not be issued for the same reason as explained in the Seek command. No other command except the Sense Interrupt command should be issued while a Relative Seek command is in progress.

## 4.0 Command Set Description (Continued)

### 4.2.15 Scan Commands

The Scan commands allow data read from the disk to be compared against data sent from the  $\mu$ P. There are three Scan commands to choose from:

Scan Equal	Disk Data = $\mu$ P Data
Scan Low or Equal	Disk Data $\leq$ $\mu$ P Data
Scan High or Equal	Disk Data $\geq$ $\mu$ P Data

Each sector is interpreted with the most significant bytes first. If the Wildcard mode is enabled in the Mode command, an FF (hex) from either the disk or the  $\mu$ P is used as a don't care byte that will always match equal. After each sector is read, if the desired condition has not been met, the next sector is read. The next sector is defined as the current sector number plus the Sector Step Size specified. The Scan command will continue until the scan condition has been met, or the EOT has been reached, or if TC is asserted.

Read errors on the disk will have the same error conditions as the Read Data command. If the SK bit is set, sectors with deleted data marks are ignored. If all sectors read are skipped, the command will terminate with D3 of ST2 set (Scan Equal Hit). The Result Phase of the command is shown in Table 4-10.

**TABLE 4-10. Scan Command Termination Values**

Command	Status Register 2		Conditions
	D2	D3	
Scan Equal	0	1	Disk = $\mu$ P
	1	0	Disk $\neq$ $\mu$ P
Scan Low or Equal	0	1	Disk = $\mu$ P
	0	0	Disk < $\mu$ P
	1	0	Disk > $\mu$ P
Scan High or Equal	0	1	Disk = $\mu$ P
	0	0	Disk < $\mu$ P
	1	0	Disk > $\mu$ P

### 4.2.16 Seek Command

The Seek command issues step pulses to move the selected drive head in or out until the desired track number is reached. During the Execution Phase of the Seek command, the track number to seek to is compared with the present track number. The controller will determine how many step pulses to issue and the DIR disk interface output will indicate which direction the R/W head should move. The DRx BUSY bit is set in the MSR for the appropriate drive. The controller will wait the Motor On time before issuing the first step pulse.

After the Motor On time, the controller will enter the Idle Phase. The execution of the actual step pulses occurs in the Drive Polling phase of the controller. The step pulse rate is determined by the value programmed in the Specify command. An interrupt will be generated one step pulse period after the last step pulse is issued. There is no Result Phase. A Sense Interrupt command should be issued to determine the cause of the interrupt.

While the internal microengine is capable of multiple seeks on 2 or more drives at the same time, software should ensure that only one drive is seeking or recalibrating at a time. This is because the drives are actually selected via the DOR, which can only select one drive at a time. No other

command except a Sense Interrupt command should be issued while a Seek command is in progress.

If the extended track range mode is enabled with the ETR bit in the Mode command, a fourth command byte should be written in the Command Phase to indicate the four most significant bits of the desired track number. Otherwise, only three command bytes should be written.

### 4.2.17 Sense Drive Status Command

The Sense Drive Status command returns the status of the selected disk drive in ST3. This command does not generate an interrupt.

### 4.2.18 Sense Interrupt Command

The Sense Interrupt command is used to determine the cause of interrupt when the interrupt is a result of the change in status of any disk drive. Four possible causes of the interrupt are:

- Upon entering the Result Phase of:
  - Read Data command
  - Read Deleted Data command
  - Read a Track command
  - Read ID command
  - Write Data command
  - Write Deleted Data command
  - Format command
  - Scan command
  - Verify command
- During data transfers in the Execution Phase while in the Non-DMA mode.
- Ready Changed State during the polling mode for an internally selected drive. (Occurs only after a hardware or software reset.)
- Seek, Relative Seek, or Recalibrate termination.

An interrupt due to reasons 1 and 2 does not require the Sense Interrupt command and is cleared automatically. This interrupt occurs during normal command operations and is easily discernible by the  $\mu$ P via the MSR. This interrupt is cleared reading or writing information from/to the Data Register (FIFO).

Interrupts caused by reason 3 and 4 are identified with the aid of the Sense Interrupt command. The interrupt is cleared after the first result byte has been read. Use bits 5, 6, and 7 of ST0 to identify the cause of the interrupt as shown in Table 4-11.

**TABLE 4-11. Status Register 0 Termination Codes**

Status Register 0			Cause
Interrupt Code		Seek End	
D7	D6	D5	
1	1	0	Internal Ready Went True
0	0	1	Normal Seek Termination
0	1	1	Abnormal Seek Termination

Issuing a Sense Interrupt command without an interrupt pending is treated as an Invalid command. If the extended track range mode is enabled, a third byte should be read in the Result Phase, which will indicate the four most significant bits of the present track number. Otherwise, only two result bytes should be read.

## 4.0 Command Set Description (Continued)

### 4.2.19 Set Track Command

This command is used to inspect or change the value of the internal Present Track Register. This could be useful for recovery from disk mis-tracking errors, where the real current track could be read through the Read ID command, and then the Set Track command could be used to set the internal Present Track Register to the correct value.

If the WNR bit is a 0, a track register is to be read. In this case, the Result Phase byte contains the value in the internal register specified, and the third byte in the Command Phase is a dummy byte.

If the WNR bit is a 1, data is written to a track register. In this case the third byte of the Command Phase is written to the specified internal track register, and the Result Phase byte contains this new value written.

The DS1 and DS0 bits select the Present Track Register for the particular drive. The internal register address depends on MSB, DS1, and DS0 as shown in Table 4-12. This command does not generate an interrupt.

TABLE 4-12. Set Track Register Address

DS1	DS0	MSB	Register Addressed
0	0	0	PTR0(LSB)
0	0	1	PTR0(MSB)
0	1	0	PTR1(LSB)
0	1	1	PTR1(MSB)
1	0	0	PTR2(LSB)
1	0	1	PTR2(MSB)
1	1	0	PTR3(LSB)
1	1	1	PTR3(MSB)

### 4.2.20 Specify Command

The Specify command sets the initial values for three internal timers. The function of these Specify parameters is described below. The parameters of this command are undefined after power up, and are unaffected by any reset. Thus, software should always issue a Specify command as part of an initialization routine. This command does not generate an interrupt.

The Motor Off and Motor On timers are artifacts of the  $\mu$ PD765. These timers determine the delay from selecting a drive motor until a read or write operation is started, and the delay of deselecting the drive motor after the command is completed. Since the PC8477B enables the drive and motor select line directly through the DOR, these timers only provide some delay from the initiation of a command until it is actually started.

**Step Rate Time:** These four bits define the time interval between successive step pulses during a seek, implied seek, recalibrate, or relative seek. The programming of this step rate is shown in Table 4-13.

TABLE 4-13. Step Rate Time (SRT) Values

Data Rate	Value	Range	Units
1 Mb/s	(16-SRT) x 0.5	0.5–8	ms
500 kb/s	(16-SRT)	1–16	ms
300 kb/s	(16-SRT) x 1.67	1.67–26.7	ms
250 kb/s	(16-SRT) x 2	2–32	ms

**Motor Off Time:** These four bits determine the simulated Motor Off time as shown in Table 4-14.

TABLE 4-14. Motor Off Time (MFT) Values

Data Rate	Mode 1 (TMR = 0)		Mode 2 (TMR = 1)		Units
	Value	Range	Value	Range	
1 Mb/s	MFT x 8	8–128	MFT x 512	512–8192	ms
500 kb/s	MFT x 16	16–256	MFT x 512	512–8192	ms
300 kb/s	MFT x 80/3	26.7–427	MFT x 2560/3	853–13653	ms
250 kb/s	MFT x 32	32–512	MFT x 1024	1024–16384	ms

**Note:** MFT = 0 is treated as Motor Off Time = 16.

**Motor On Time:** These seven bits determine the simulated Motor On time as shown in Table 4-15.

TABLE 4-15. Motor On Time (MNT) Values

Data Rate	Mode 1 (TMR = 0)		Mode 2 (TMR = 1)		Units
	Value	Range	Value	Range	
1 Mb/s	MNT	1–128	MNT x 32	32–4096	ms
500 kb/s	MNT	1–128	MNT x 32	32–4096	ms
300 kb/s	MNT x 10/3	3.3–427	MNT x 160/3	53–6827	ms
250 kb/s	MNT x 4	4–512	MNT x 64	64–8192	ms

**Note 1:** MNT = 0 is treated as Motor On Time = 128.

**Note 2:** For PC8477A at 500 kb/s when TMR = 0 the value is MNT x 2 and range is 2–256.

**DMA:** This bit selects the data transfer mode in the Execution Phase of a read, write, or scan operation.

0	DMA mode is selected.
1	Non-DMA mode is selected.

### 4.2.21 Verify Command

The Verify command reads logical sectors containing a Normal Data AM from the selected drive without transferring the data to the host. This command is identical to the Read Data command, except that no data is transferred during the Execution Phase.

The Verify command is designed for post-format or post-write verification. Data is read from the disk, as the controller checks for valid Address Marks in the Address and Data Fields. The CRC is computed and checked against the previously stored value on the disk. The EOT value should be set to the final sector to be checked on each side. If EOT is greater than the number of sectors per side, the command will terminate with an error and no useful Address Mark or CRC data will be given.

The TC pin cannot be used to terminate this command since no data is transferred. The command can simulate a TC by setting the EC bit to a 1. In this case, the command will terminate when SC (Sector Count) sectors have been read. (If SC = 0 then 256 sectors will be verified.) If EC = 0, then the command will terminate when EOT is equal to the last sector to be checked. In this case, the Data Length parameter should be set to FF hex. Refer to Table 4-7 for the Result Phase values for a successful completion of the command. Also see Table 4-16 for further explanation of the result bytes with respect to the MT and EC bits.

## 4.0 Command Set Description (Continued)

TABLE 4-16. Verify Command Result Phase Table

MT	EC	SC/EOT Value	Termination Result
0	0	DTL used (should be FF hex) EOT ≤ # Sectors per Side	No Errors
0	0	DTL used (should be FF hex) EOT > # Sectors per Side	Abnormal Termination
0	1	SC ≤ # Sectors per Side AND SC ≤ EOT	No Errors
0	1	SC > # Sectors Remaining OR SC > EOT	Abnormal Termination
1	0	DTL used (should be FF hex) EOT ≤ # Sectors per Side	No Errors
1	0	DTL used (should be FF hex) EOT > # Sectors per Side	Abnormal Termination
1	1	SC ≤ # Sectors per Side AND SC ≤ EOT	No Errors
1	1	SC ≤ (EOT × 2) AND EOT ≤ # Sectors per Side	No Errors
1	1	SC > (EOT × 2)	Abnormal Termination

**Note 1:** # Sectors per Side = number of formatted sectors per each side of the disk.

**Note 2:** # Sectors Remaining = number of formatted sectors left which can be read, which includes side 1 of the disk if the MT bit is set to 1.

**Note 3:** If MT = 1 and the SC value is greater than the number of remaining formatted sectors on side 0, verifying will continue on side 1 of the disk.

### 4.2.22 Version Command

The Version command can be used to determine the floppy controller being used. The Result Phase uniquely identifies the floppy controller version. The PC8477B returns a value of 90 hex in order to be compatible with the 82077. The DP8473 and other NEC765 compatible controllers will return a value of 80 hex (invalid command).

### 4.2.23 Write Data Command

The Write Data command receives data from the host and writes logical sectors containing a Normal Data AM to the selected drive. The operation of this command is similar to the Read Data command except that the data is transferred from the  $\mu$ P to the controller instead of the other way around.

The controller will simulate the Motor On time before starting the operation. If implied seeks are enabled, the seek and sense interrupt functions are then performed. The controller then starts the Data Separator and waits for the Data Separator to find the next sector Address Field. The controller compares the Address ID (track, head, sector, bytes per sector) with the desired ID specified in the Command Phase. If there is no match, the controller waits to find the next sector Address Field. This process continues until the desired sector is found. If an error condition occurs, the IC bits in ST0 are set to Abnormal Termination, and the controller enters the Result Phase. Possible errors are:

1. The  $\mu$ P aborted the command by writing to the FIFO. If there is no disk in the drive, the controller will hang up. The  $\mu$ P must then take the controller out of this hung state by writing a byte to the FIFO. This will put the controller into the Result Phase.

2. Two index pulses were detected since the search began, and no valid ID has been found. If the track address ID differs, the WT bit or BT bit (if the track address is FF hex) will be set in ST2. If the head, sector, or bytes per sector code did not match, the ND bit is set in ST1. If the Address Field AM was never found, the MA bit is set in ST1.
3. The Address Field was found with a CRC error. The CE bit is set in ST1.
4. If the controller detects the Write Protect disk interface input is asserted, bit 1 of ST1 is set.

If the correct Address Field is found, the controller waits for all (conventional mode) or part (perpendicular mode) of GAP2 to pass. The controller will then write the preamble field, address marks, and data bytes to the Data Field. The data bytes are transferred to the controller by the  $\mu$ P.

Having finished writing the sector, the controller will continue reading the next logical sector unless one or more of the following termination conditions occurred:

1. The DMA controller asserted TC. The IC bits in ST0 are set to Normal Termination.
2. The last sector address (of side 1 if MT was set) was equal to EOT. The EOT bit in ST1 is set. The IC bits in ST0 are set to Abnormal Termination. This is the expected condition during Non-DMA transfers.
3. Underrun error. The OR bit in ST1 is set. The IC bits in ST0 are set to Abnormal Termination. If the  $\mu$ P cannot service a transfer request in time, the last correctly written byte will be written to the disk.

## 4.0 Command Set Description (Continued)

If MT was set in the Opcode command byte, and the last sector of side 0 has been transferred, the controller will then continue with side 1, starting with sector 1 and continuing until EOT Sector # is reached or TC occurs. Result phase termination values listed in Table 4-7.

### 4.2.24 Write Deleted Data

The Write Deleted Data command receives data from the host and writes logical sectors containing a Deleted Data AM to the selected drive. This command is identical to the Write Data command except that a Deleted Data AM is written to the Data Field instead of a Normal Data AM.

## 5.0 Functional Description

The PC8477B is pin compatible with the 82077AA floppy disk controller. It is software compatible with the DP8473 and 82077AA floppy disk controllers. Upon a power-on reset, the 16 byte FIFO will be disabled. Also, the disk interface outputs will be configured as active push-pull outputs, which are compatible with both CMOS inputs and open-collector resistor terminated disk drive inputs. The FIFO can be enabled with the Configure command. The FIFO can be very useful at the higher data rates, with systems that have a large amount of DMA bus latency, or with multi-tasking systems such as the EISA or MCA bus structures.

The PC8477B will support all the DP8473 Mode command features as well as some additional features. These include control over the enabling of the FIFO for reads and writes, a Non-Burst mode for the FIFO, a bit that will configure the disk interface outputs as open-drain outputs, and programmability of the DENSEL output.

### 5.1 MICROPROCESSOR INTERFACE

The PC8477B interface to the microprocessor consists of the  $\overline{CS}$ ,  $\overline{RD}$ , and  $\overline{WR}$  lines, which access the chip for reads and writes; the data lines D7–D0; the address lines A2–A0, which select the register to be accessed (see Table 3-1); the INT signal, and the DMA interface signals DRQ,  $\overline{DACK}$ , and TC. It is through this microprocessor interface that the floppy controller receives commands, transfers data, and returns status information.

### 5.2 MODES OF OPERATION

The PC8477B has three modes of operation: PC-AT mode, PS/2 mode, and Model 30 mode, which are determined by the state of the IDENT pin and MFM pin. IDENT can be tied directly to  $V_{CC}$  or GND. The MFM pin must be tied high or low with a 10 k $\Omega$  resistor (there is an internal 40 k $\Omega$ –50 k $\Omega$  resistor on the MFM pin). The state of these pins is interrogated by the controller during a chip reset to determine the mode of operation. See Section 3.0 Register Description for more details on the register set used for each mode of operation. After chip reset, the state of IDENT can be changed to change the polarity of DENSEL (see Section 2.0 Pin Description).

**PC-AT Mode**—(IDENT tied high, MFM is a don't care): The PC-AT register set is enabled. The DMA enable bit in the Digital Output Register becomes valid (INT and DRQ can be TRI-STATE). TC and DENSEL become active high signals (defaults to a 5.25" floppy drive).

**PS/2 Mode**—(IDENT tied low, MFM pulled high internally): This mode supports the PS/2 Models 50/60/80 configuration and register set. The DMA enable bit in the Digital Output Register becomes a don't care (INT and DRQ signals will always be valid). TC and DENSEL become active low signals (default to 3.5" floppy drive).

**Model 30 Mode**—(IDENT tied low, MFM pulled low externally): This mode supports the PS/2 Model 30 configuration and register set. The DMA enable bit in the Digital Output Register becomes valid (INT and DRQ can be TRI-STATE). TC is active high and DENSEL becomes active low (default to 3.5" floppy drive).

### 5.3 CONTROLLER PHASES

The PC8477B has three separate phases of a command, the Command Phase, the Execution Phase, and the Result Phase. Each of these controller phases will determine how data is transferred between the floppy controller and the host microprocessor. In addition, when no command is in progress, the controller is in the Idle Phase or Drive Polling Phase.

#### 5.3.1 Command Phase

During the Command Phase, the  $\mu P$  writes a series of bytes to the Data Register. The first command byte contains the opcode for the command, and the controller will know how many more bytes to expect based on this opcode byte. The remaining command bytes contain the particular parameters required for the command. The number of command bytes will vary for each particular command. All the command bytes must be written in the order specified in the Command Description Table. The Execution Phase starts immediately after the last byte in the Command Phase is written. Prior to performing the Command Phase, the Digital Output Register should be set and the data rate should be set with the Data Rate Select Register or Configuration Control Register.

The Main Status Register controls the flow of command bytes, and must be polled by the software before writing each Command Phase byte to the Data Register. Prior to writing a command byte, the RQM bit (D7) must be set and the DIO bit (D6) must be cleared in the MSR. After the first command byte is written to the Data Register, the CMD PROG bit (D4) will also be set and will remain set until the last Result Phase byte is read. If there is no Result Phase, the CMD PROG bit will be cleared after the last command byte is written.

A new command may be initiated after reading all the result bytes from the previous command. If the next command requires selecting a different drive or changing the data rate, the DOR and DSR or CCR should be updated. If the command is the last command, then the software should de-select the drive.

**Note:** As a general rule, the operation of the controller core is independent of how the  $\mu P$  updates the DOR, DSR, and CCR. The software must ensure that the manipulation of these registers is coordinated with the controller operation.

#### 5.3.2 Execution Phase

During the Execution Phase, the disk controller performs the desired command. Commands that involve data transfers, such as a read, write, or format operation, will require the  $\mu P$  to write or read data to or from the Data Register at this time. Some commands such as a Seek or Recalibrate will control the read/write head movement on the disk drive during the Execution Phase via the disk interface signals. The execution of other commands does not involve any action by the  $\mu P$  or disk drive, and consists of an internal operation by the controller.

If there is data to be transferred between the  $\mu P$  and the controller during the Execution, there are three methods that can be used, DMA mode, interrupt transfer mode, and



## 5.0 Functional Description (Continued)

software polling mode. The last two modes are called the Non-DMA modes. The DMA mode is used if the system has a DMA controller. This allows the  $\mu$ P to do other tasks while the data transfer takes place during the Execution Phase. If the Non-DMA mode is used, an interrupt is issued for each byte transferred during the Execution Phase. Also, instead of using the interrupt during Non-DMA mode, the Main Status Register can be polled by software to indicate when a byte transfer is required. All of these data transfer modes will work with the FIFO enabled or disabled.

### 5.3.2.1 DMA Mode—FIFO Disabled

The DMA mode is selected by writing a 0 to the DMA bit in the Specify command and by setting the DMA enabled bit (D3) in the DOR. With the FIFO disabled, a DMA request (DRQ) is generated in the Execution Phase when each byte is ready to be transferred. The DMA controller should respond in the DRQ with a DMA acknowledge ( $\overline{\text{DACK}}$ ) and a read or write strobe. The DRQ will be cleared by the leading edge of the active low  $\overline{\text{DACK}}$  input signal. After the last byte is transferred, an interrupt is generated, indicating the beginning of the Result Phase. During DMA operations the chip select input ( $\overline{\text{CS}}$ ) must be held high. The  $\overline{\text{DACK}}$  signal will act as the chip select for the FIFO in this case, and the state of the address lines A2–A0 is a don't care. The Terminal Count (TC) signal can be asserted by the DMA controller to terminate the data transfer at any time. Due to internal gating, TC is only recognized when  $\overline{\text{DACK}}$  is low.

**PC-AT Mode:** When in the PC-AT interface mode with the FIFO disabled, the controller will be in single byte transfer mode. That is, the system will have one byte time to service a DMA request (DRQ) from the controller. DRQ will be deasserted between each byte.

**PS/2 and Model 30 Modes:** When in the PS/2 or Model 30 modes, DMA transfers with the FIFO disabled are performed differently. Instead of a single byte transfer mode, the FIFO will actually be enabled with  $\text{THRESH} = 0\text{F}$  (hex). Thus, DRQ will be asserted when one byte has entered the FIFO during reads, and when one byte can be written to the FIFO during writes. DRQ will be deasserted by the leading edge of the  $\overline{\text{DACK}}$  input, and will be reasserted when  $\overline{\text{DACK}}$  goes inactive high. This operation is very similar to Burst mode transfer with the FIFO enabled except that DRQ is deasserted between each byte.

### 5.3.2.2 DMA Mode—FIFO Enabled

#### Read Data Transfers

Whenever the number of bytes in the FIFO is greater than or equal to  $(16 - \text{THRESH})$ , a DRQ is generated. This is the trigger condition for the FIFO read data transfers from the floppy controller to the  $\mu$ P.

**Burst Mode:** DRQ will remain active until enough bytes have been read from the controller to empty the FIFO.

**Non-Burst Mode:** DRQ will be deasserted after each read transfer. If the FIFO is not completely empty, DRQ will be reasserted after a 350 ns delay. This will allow other higher priority DMA transfers to take place between floppy transfers. In addition, this mode will allow the controller to work correctly in systems where the DMA controller is put into a read verify mode, where only  $\overline{\text{DACK}}$  signals are sent to the FDC, with no  $\overline{\text{RD}}$  pulses. This read verify mode of the DMA controller is used in some PC software. The FIFO Non-Burst mode allows the  $\overline{\text{DACK}}$  input from the DMA controller to be strobed, which will correctly clock data from the FIFO.

For both the Burst and Non-Burst modes, when the last byte in the FIFO has been read, DRQ will go inactive. DRQ will then be reasserted when the FIFO trigger condition is satisfied. After the last byte of a sector has been read from the disk, DRQ is again generated even if the FIFO has not yet reached its threshold trigger condition. This will guarantee that all the current sector bytes are read from the FIFO before the next sector byte transfer begins.

#### Write Data Transfers

Whenever the number of bytes in the FIFO is less than or equal to THRESH, a DRQ is generated. This is the trigger condition for the FIFO write data transfers from the  $\mu$ P to the floppy controller.

**Burst Mode:** DRQ will remain active until enough bytes have been written to the controller to completely fill the FIFO.

**Non-Burst Mode:** DRQ will be deasserted after each write transfer. If the FIFO is not yet full, DRQ will be reasserted after a 350 ns delay. This deassertion of DRQ will allow other higher priority DMA transfers to take place between floppy transfers.

The FIFO has a byte counter which will monitor the number of bytes being transferred to the FIFO during write operations for both Burst and Non-Burst modes. When the last byte of a sector is transferred to the FIFO, DRQ will be deasserted even if the FIFO has not been completely filled. In this way, the FIFO will be cleared after each sector is written. Only after the floppy controller has determined that another sector is to be written will DRQ be asserted again. Also, since DRQ is deasserted immediately after the last byte of a sector is written to the FIFO, the system does not need to tolerate any DRQ deassertion delay and is free to do other work.

#### Read and Write Data Transfers

The  $\overline{\text{DACK}}$  input signal from the DMA controller may be held active during an entire burst or it may be strobed for each byte transferred during a read or write operation. When in the Burst mode, the floppy controller will deassert DRQ as soon as it recognizes that the last byte of a burst was transferred. If  $\overline{\text{DACK}}$  is strobed for each byte, the leading edge of this strobe is used to deassert DRQ. If  $\overline{\text{DACK}}$  is strobed,  $\overline{\text{RD}}$  or  $\overline{\text{WR}}$  are not required. This is the case during the Read Verify mode of the DMA Controller. If  $\overline{\text{DACK}}$  is held active during the entire burst, the trailing edge of the  $\overline{\text{RD}}$  or  $\overline{\text{WR}}$  strobe is used to deassert DRQ. DRQ will be deasserted within 50 ns of the leading edge of  $\overline{\text{DACK}}$ ,  $\overline{\text{RD}}$ , or  $\overline{\text{WR}}$ . This quick response should prevent the DMA controller from transferring extra bytes in most applications.

#### Overrun Errors

An overrun or underrun error will terminate the execution of the command if the system does not transfer data within the allotted data transfer time (see Section 3.7), which will put the controller into the Result Phase. During a read overrun, the  $\mu$ P is required to read the remaining bytes of the sector before the controller will assert INT, signifying the end of execution. During a write operation, an underrun error will terminate the Execution Phase after the controller has written the remaining bytes of the sector with the last correctly written byte to the FIFO and generated the CRC bytes. Whether there is an error or not, an interrupt is generated at the end of the Execution Phase, and is cleared by reading the first Result Phase byte.

## 5.0 Functional Description (Continued)

$\overline{DACK}$  asserted by itself without a  $\overline{RD}$  or  $\overline{WR}$  strobe is also counted as a transfer. If  $\overline{RD}$  or  $\overline{WR}$  are not being strobed for each byte, then  $\overline{DACK}$  must be strobed for each byte so that the floppy controller can count the number of bytes correctly. A new command, the Verify command, has been added to allow easier verification of data written to the disk without the need of actually transferring the data on the data bus.

### 5.3.2.3 Interrupt Mode—FIFO Disabled

If the Interrupt (Non-DMA) mode is selected, INT is asserted instead of DRQ when each byte is ready to be transferred. The Main Status Register should be read to verify that the interrupt is for a data transfer. The RQM and NON DMA bits (D7 and D5) in the MSR will be set. The interrupt will be cleared when the byte is transferred to or from the Data Register.  $\overline{CS}$  and  $\overline{RD}$  or  $\overline{CS}$  and  $\overline{WR}$  must be used to transfer the data in or out of the Data Register (A2–A0 must be valid).  $\overline{CS}$  asserted by itself is not significant.  $\overline{CS}$  must be asserted with  $\overline{RD}$  or  $\overline{WR}$  for a read or write transfer to be recognized.

The  $\mu P$  should transfer the byte within the data transfer service time (see Section 3.7). If the byte is not transferred within the time allotted, an Overrun Error will be indicated in the Result Phase when the command terminates at the end of the current sector.

An interrupt will also be generated after the last byte is transferred. This indicates the beginning of the Result Phase. The RQM and DIO bits (D7 and D6) in the MSR will be set, and the NON DMA bit (D5) will be cleared. This interrupt is cleared by reading the first result byte.

### 5.3.2.4 Interrupt Mode—FIFO Enabled

The Interrupt (Non-DMA) mode with the FIFO enabled is very similar to the Non-DMA mode with the FIFO disabled. In this case, INT is asserted instead of DRQ under the exact same FIFO threshold trigger conditions. The MSR should be read to verify that the interrupt is for a data transfer. The RQM and NON DMA bits (D7 and D5) in the MSR will be set.  $\overline{CS}$  and  $\overline{RD}$  or  $\overline{CS}$  and  $\overline{WR}$  must be used to transfer the data in or out of the Data Register (A2–A0 must be valid).  $\overline{CS}$  asserted by itself is not significant.  $\overline{CS}$  must be asserted with  $\overline{RD}$  or  $\overline{WR}$  for a read or write transfer to be recognized.

The Burst mode may be used to hold the INT pin active during a burst, or the Non-Burst mode may be used to toggle the INT pin for each byte of a burst. The Main Status Register is always valid from the  $\mu P$  point of view. For example, during a read command, after the last byte of data has been read from the disk and placed in the FIFO, the MSR will still indicate that the Execution Phase is active, and that data needs to be read from the Data Register. Only after the last byte of data has been read by the  $\mu P$  from the FIFO will the Result Phase begin.

The same overrun and underrun error procedures from the DMA mode apply to the Non-DMA mode. Also, whether there is an error or not, an interrupt is generated at the end of the Execution Phase, and is cleared by reading the first Result Phase byte.

### 5.3.2.5 Software Polling

If the Non-DMA Mode is selected and interrupts are not suitable, the  $\mu P$  can poll the MSR during the Execution Phase to determine when a byte is ready to be transferred. The RQM bit (D7) in the MSR reflects the state of the INT

signal. Otherwise, the data transfer is similar to the Interrupt Mode described above. This is true for the FIFO enabled or disabled.

### 5.3.3 Result Phase

During the Result Phase, the  $\mu P$  reads a series of bytes from the data register. These bytes indicate the status of the command. This status may indicate whether the command executed properly, or contain some control information (see the Command Description Table and Status Register Description). These Result Phase bytes are read in the order specified for that particular command. Some commands will not have a result phase. Also, the number of result bytes varies with each command. All of the result bytes must be read from the Data Register before the next command can be issued.

Like the Command Phase, the Main Status Register controls the flow of result bytes, and must be polled by the software before reading each Result Phase byte from the Data Register. The RQM bit (D7) and DIO bit (D6) must both be set before each result byte can be read. After the last result byte is read, the COM PROG bit (D4) in the MSR will be cleared, and the controller will be ready for the next command.

### 5.3.4 Idle Phase

After a hardware or software reset, or after the chip has recovered from the power down mode, the controller enters the Idle Phase. Also, when there are no commands in progress the controller will be in the Idle Phase. The controller will be waiting for a command byte to be written to the Data Register. The RQM bit will be set and the DIO bit will be cleared in the MSR. After receiving the first command (opcode) byte, the controller will enter the Command Phase. When the command is completed the controller again enters the Idle Phase. The Data Separator will remain synchronized to the reference frequency while the controller is idle. While in the Idle Phase, the controller will periodically enter the Drive Polling Phase (see below).

### 5.3.5 Drive Polling Phase

While in the Idle Phase the controller will enter a Drive Polling Phase every 1 ms (based on the 500 kb/s data rate). While in the Drive Polling Phase, the controller will interrogate the Ready Changed status for each of the four logical drives. The internal Ready line for each drive is toggled only after a hardware or software reset, and an interrupt will be generated for drive 0. At this point, the software must issue four Sense Interrupt commands to clear the Ready Changed State status for each drive. This requirement can be eliminated if drive polling is disabled via the POLL bit in the Configure command. The Configure command must be issued within 500  $\mu s$  of the hardware or software reset for drive polling to be disabled.

Even if drive polling is disabled, drive stepping and delayed power down will occur in the Drive Polling Phase. The controller will check the status of each drive and if necessary it will issue a step pulse on the STEP output with the DIR signal at the appropriate logic level. Also, the controller uses the Drive Polling Phase to control the Automatic Low Power mode. When the Motor Off time has expired, the controller will wait 512 ms (based on 500 kb/s or 1 Mbs data rate) before powering down if this function is enabled via the Mode command.



## 5.0 Functional Description (Continued)

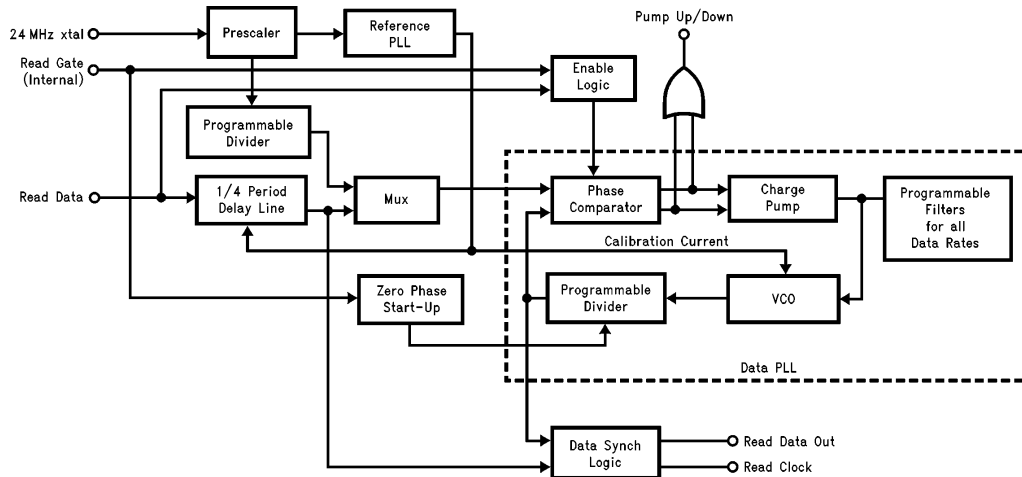

TL/F/11332-5

FIGURE 5-1. PC8477B Data Separator Block Diagram

### 5.4 DATA SEPARATOR

The internal data separator consists of an analog PLL and its associated circuitry. The PLL synchronizes the raw data signal read from the disk drive. The synchronized signal is used to separate the encoded clock and data pulses. The data pulses are deserialized into bytes and then sent to the  $\mu$ P by the controller.

The main PLL consists of five main components, a phase comparator, a charge pump, a filter, a voltage controlled oscillator (VCO), and a programmable divider. The phase comparator detects the difference between the phase of the divider's output and the phase of the raw data being read from the disk. This phase difference is converted to a current by the charge pump, which either charges or discharges one of three filters which is selected based on the data rate. The resulting voltage on the filter changes the frequency of the VCO and the divider output to reduce the phase difference between the input data and the divider's output. The PLL is "locked" when the frequency of the divider is exactly the same as the average frequency of the data read from the disk. A block diagram of the data separator is shown in *Figure 5-1*.

To ensure optimal performance, the data separator incorporates several additional circuits. The quarter period delay line is used to determine the center of each bit cell, and to

disable the phase comparator when the raw data signal is missing a clock or data pulse in the MFM or FM pattern. A secondary PLL is used to automatically calibrate the quarter period delay line. The secondary PLL also calibrates the center frequency of the VCO.

To eliminate the logic associated with controlling multiple data rates, the PC8477B supports each of the four data rates (250, 300, 500 kb/s, and 1 Mb/s) with a separate, optimized internal filter. The appropriate filter for each data rate is automatically switched into the data separator circuit when the data rate is selected via the Data Rate Select or Configuration Control Register. These filters have been optimized through lab experimentation, and are designed into the controller to reduce the external component cost associated with the floppy controller. The PC8477B has a dynamic window margin and lock range performance capable of handling a wide range of floppy disk drives. Also, the data separator will work well under a variety of conditions, including the high motor speed fluctuations of floppy compatible tape drives.

The controller takes best advantage of the internal analog data separator by implementing a sophisticated read algorithm. The ID search algorithm, shown in *Figure 5-2*, enhances the PLL's lock characteristics by forcing the PLL to relock to the crystal reference frequency any time the data separator attempts to lock to a non-preamble pattern. This algorithm ensures that the PLL is not thrown way out of lock by write splices or bad data fields.

## 5.0 Functional Description (Continued)

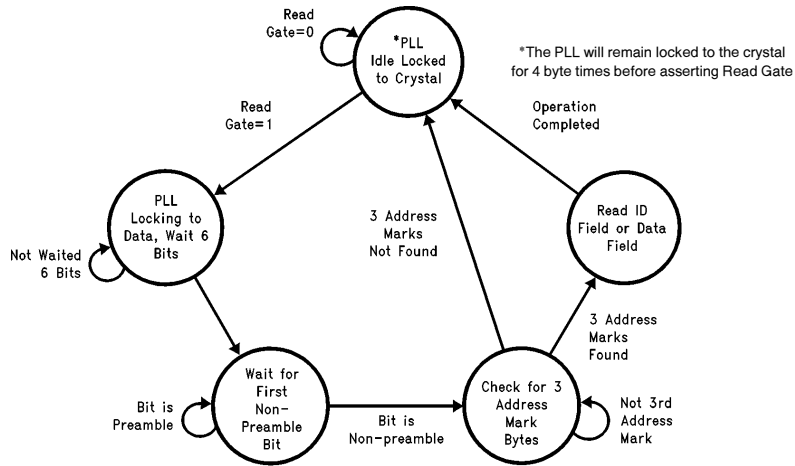

TL/F/11332-6

FIGURE 5-2. Read Data Algorithm—State Machine

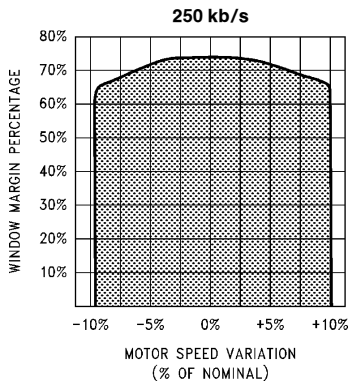

TL/F/11332-7

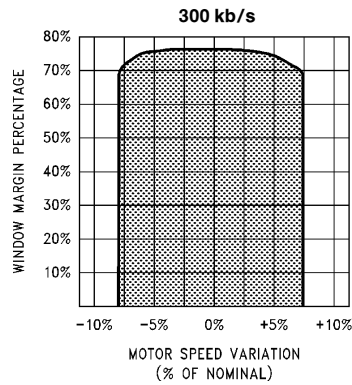

TL/F/11332-8

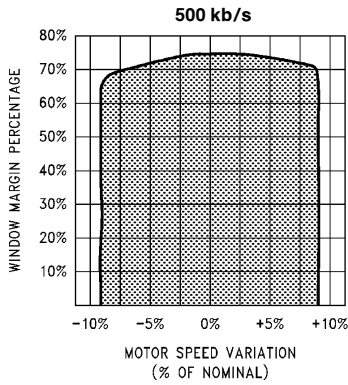

TL/F/11332-9

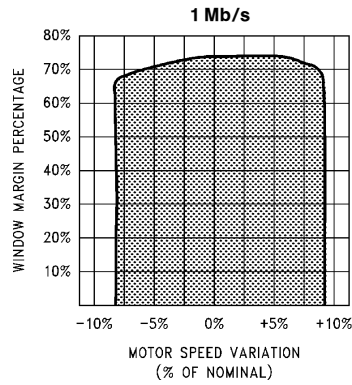

TL/F/11332-10

FIGURE 5-3. PC8477B Dynamic Window Margin Performance

(Typical performance at  $V_{CC} = 5.0V$ ,  $25^{\circ}C$ )

## 5.0 Functional Description (Continued)

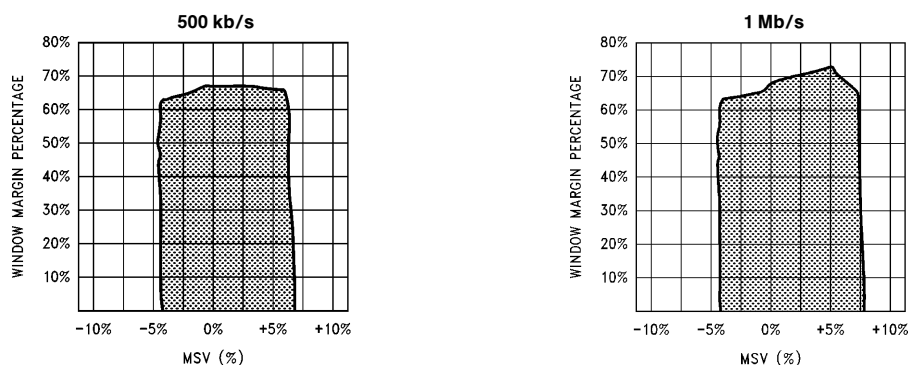

FIGURE 5-4. PC8477B Dynamic Window Margin Performance with  $\pm 3\%$  ISV at 1 kHz

(Typical performance at  $V_{CC} = 5.0V$ ,  $25^{\circ}C$ )

### 5.5 CRYSTAL OSCILLATOR

The PC8477B is clocked by a single 24 MHz signal for the 250 kb/s, 300 kb/s, 500 kb/s, and 1 Mb/s data rates. An on-chip oscillator is provided to enable the attachment of a crystal or a clock signal. If a crystal is used, the following parameters are required:

#### Crystal Specifications

Frequency:	24 MHz
Mode:	Parallel Resonant (preferred) Fundamental Mode
Effective Series Resistance (ESR):	Less than 50 $\Omega$
Shunt Capacitance:	Less than 7 pF

#### Recommended Crystals

NEL Frequency Controls:	NEL-C5480N	24 MHz
	NEL-C2800N	24 MHz
SaRonix:	NMP240	24 MHz

A parallel resonant crystal is preferred if at all possible. In some cases, a series resonant crystal can be used, but care must be taken to ensure that the crystal does not oscillate at a sub-harmonic frequency. The oscillator circuit is able to utilize high profile, low profile, and surface mount type crystal enclosures. External bypass capacitors (5 pF to 15 pF) should be connected from XTAL1 and XTAL2 to GND. If an external oscillator circuit is used, it must have a duty cycle of at least 40%–60%, and minimum input levels of 2.0V and 0.8V. The controller should be configured so that the external oscillator clock is input into the XTAL1/CLK pin, and XTAL2 is left unconnected.

### 5.6 DYNAMIC WINDOW MARGIN PERFORMANCE

The performance of the data separator is measured by its ability to read and decode incoming pulses shifted away from the nominal position. The percentage window margin indicates how much bit shift the data separator will tolerate and still be able to read correctly. For a Dynamic Window Margin test all the bits in the data pattern are subject to jitter

(as they would be in a real floppy drive), and the frequency of the data stream is subject to changes arising from motor speed variations. Typical dynamic margin performance curves for the PC8477B are listed in *Figure 5-3*. These measurements are taken using a FlexStar FS-540 Disk Simulator with a repetitive "DB6" data pattern. The graphs indicate motor speed variation (MSV) vs bit jitter tolerance for the floppy controller. For reliable performance with tape drives the data separator needs to be able to track to instantaneous changes as well. *Figure 5-4* shows jitter tolerance vs MSV with an added instantaneous speed variation (ISV) of  $\pm 3\%$  at frequency of 1 kHz. These are typical performance curves and measured at  $V_{CC} = 5.0V$ , and  $25^{\circ}C$ . A good data separator should be able to tolerate at least  $\pm 6\%$  MSV and 60% window margin.

### 5.7 PERPENDICULAR RECORDING MODE

The PC8477B is fully compatible with perpendicular recording mode disk drives at all data rates. These perpendicular mode drives are also called 4 Mbyte (unformatted) or 2.88 Mbyte (formatted) drives, which refers to their maximum storage capacity. Perpendicular recording will orient the magnetic flux changes (which represent bits) vertically on the disk surface, allowing for a higher recording density than the conventional longitudinal recording methods. With this increase in recording density comes an increase in the data rate of up to 1 Mb/s, thus doubling the storage capacity. In addition, the perpendicular 2.88M drive is read/write compatible with 1.44M and 720k diskettes (500 kb/s and 250 kb/s respectively).

The 2.88M drive has unique format and write data timing requirements due to its read/write head and pre-erase head design (see *Figure 5-5*). Unlike conventional disk drives which have only a read/write head, the 2.88M drive has both a pre-erase head and read/write head. With conventional disk drives, the read/write head by itself is able to rewrite the disk without problems. For 2.88M drives, a pre-erase head is needed to erase the magnetic flux on the disk surface before the read/write can write to the disk surface. The pre-erase head is activated during disk write operations only, i.e. Format and Write Data commands.

## 5.0 Functional Description (Continued)

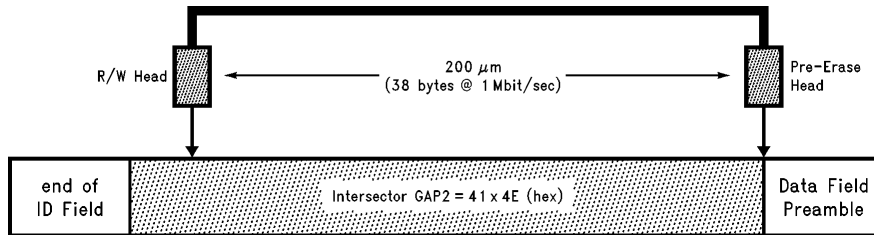

TL/F/11332-13

FIGURE 5-5. Perpendicular Recording Drive R/W Head and Pre-Erase Head

In 2.88M drives, the pre-erase head leads the read/write head by  $200\ \mu\text{m}$ , which translates to 38 bytes at 1 Mb/s (19 bytes at 500 kb/s). For both conventional and perpendicular drives, WGATE is asserted with respect to the position of the read/write head. With conventional drives, this means that WGATE is asserted when the read/write head is located at the beginning of the Data Field preamble. With the 2.88M drives, since the preamble must be pre-erased before it is rewritten, WGATE should be asserted when the pre-erase head is located at the beginning of the Data Field preamble. This means that WGATE should be asserted when the read/write head is at least 38 bytes (at 1 Mb/s) before the preamble. See Table 4-4 for a description of the WGATE timing for perpendicular drives at the various data rates.

Because of the 38 byte spacing between the read/write head and the pre-erase head at 1 Mb/s, the GAP2 length of 22 bytes used in the standard IBM disk format is not long enough. There is a new format standard for 2.88M drives at 1 Mb/s called the Perpendicular Format, which increases the GAP2 length to 41 bytes (see Figure 4-1).

The Perpendicular Mode command of the PC8477B will put the floppy controller into perpendicular recording mode, which allows it to read and write perpendicular media. Once this command is invoked, the read, write and format commands can be executed in the normal manner. The perpendicular mode of the floppy controller will work at all data rates, adjusting the format and write data parameters accordingly. See Section 4.2.8 for more details.

### 5.8 DATA RATE SELECTION

The data rate can be chosen two different ways with the PC8477B. For PC compatible software, the Configuration Control Register at address 3F7 (hex) is used to program the data rate for the floppy controller. The lower bits D1 and D0 are used in the CCR to set the data rate. The other bits should be set to zero. See Table 3-6 for the data rate select encoding.

The data rate can also be set using the Data Rate Select Register at address 4. Again, the lower two bits of

the register are used to set the data rate. The encoding of these bits is exactly the same as those in the CCR. The remainder of the bits in the DSR are used for other functions. Consult the Register Description (Section 5.1) for more details.

The data rate is determined by the last value that is written to either the CCR or the DSR. In other words, either the CCR or the DSR can override the data rate selection of the other register.

When the data rate is selected, the microengine and data separator clocks are scaled appropriately. Also, the DRATE0 and DRATE1 output pins will reflect the state of the data select bits that were last written to either the CCR or the DSR.

### 5.9 WRITE PRECOMPENSATION

Write precompensation is a way of preconditioning the WDATA output signal to adjust for the effects of bit shift on the data as it is written to the disk surface. Bit shift is caused by the magnetic interaction of data bits as they are written to the disk surface, and has the effect of shifting these data bits away from their nominal position in the serial MFM or FM data pattern. Data that is subject to bit shift is much harder to read by a data separator, and can cause soft read errors. Write precompensation predicts where bit shift could occur within a data pattern. It then shifts the individual data bits early, late, or not at all such that when they are written to the disk, the resultant shifted data bits will be back in their nominal position.

The PC8477B supports software programmable write precompensation. Upon power up, the default write precomp values will be used (see Table 3-5). The programmer can choose a different value of write precomp with the DSR register if desired (see Table 3-4). Also on power up, the default starting track number for write precomp is track zero. This starting track number for write precomp can be changed with the Configure command.

### 5.10 LOW POWER MODE LOGIC

The PC8477B supports a low power mode, in which the oscillator and data separator circuitry are turned off. The floppy controller will typically draw about 1 mA while in low

## 5.0 Functional Description (Continued)

power. Because the internal circuitry is driven from the oscillator clock, it will also be disabled while the oscillator is off. Upon entering the power down state, the RQM (Request For Master) bit in the MSR will be cleared.

There are two ways the part can recover from the power down state and re-enable the oscillator and data separator. The part will power up after a software reset via the DOR or DSR. Since a software reset requires reinitialization of the controller, this method can be undesirable. The part will also power up after a read or write to either the Data Register or Main Status Register. This is the preferred method of power up since all internal register values are retained. It may take a few milliseconds for the oscillator to stabilize, and the  $\mu\text{P}$  will be prevented from issuing commands during this time through the normal Main Status Register protocol. That is, the RQM bit in the MSR will be a 0 until the oscillator has stabilized. When the controller has completely stabilized from power up, the RQM bit in the MSR is set to 1 and the controller can continue where it left off.

There are two modes of low power in the floppy controller: manual low power and automatic low power. Manual low power is enabled by writing a 1 to bit D6 of the DSR. The chip will go into low power immediately. This bit will be cleared to 0 after the chip is brought out of low power. Manual low power can also be accessed via the Mode command. The function of the manual low power mode is a logical OR function between the DSR low power bit and the Mode command manual low power bit setting. When using an external clock with the PC8477B, you must wait at least 2 ms after low power mode is invoked before turning off the external clock. This will insure the PC8477B is powered down correctly.

Automatic low power mode will switch the controller into low power 500 ms after it has entered the idle state (based on the 500 kb/s MFM data rate). Once the auto low power mode is set, it does not have to be set again, and the controller will automatically go into low power mode after it has entered the idle state. Automatic low power mode can only be set with the Mode command. Power up from automatic low power is performed by the method described above.

The Data Rate Select, Digital Output, and Configuration Control Registers are unaffected by the power down mode. They will remain active. It is up to the user to ensure that the Motor and Drive Select signals are turned off.

### 5.11 RESET OPERATION

The PC8477B floppy controller can be reset by hardware or software. Hardware reset is enacted by pulsing the RESET input pin. A hardware reset will set all of the user addressable registers and internal registers to their default values. The Specify command values will be don't cares, so they must be reinitialized. The major default conditions are: FIFO disabled, FIFO threshold = 0, Implied Seeks disabled, and Drive Polling enabled.

A software reset can be performed through the Digital Output Register or Data Rate Select Register. The DSR reset bit is self-clearing, while the DOR reset bit is not self-clearing. If the LOCK bit in the Lock command was set to a 1 previous to the software reset, the FIFO, THRESH, and PRETRK parameters in the Configure command will be retained. In addition, the FWR, FRD, and BST parameters in the Mode command will be retained if LOCK is set to 1. This function eliminates the need for total reinitialization of the controller after a software reset.

After a hardware or software reset, the Main Status Register is immediately available for read access by the  $\mu\text{P}$ . It will return a 00 hex value until all the internal registers have been updated and the data separator is stabilized. When the controller is ready to receive a command byte, the MSR will return a value of 80 hex (Request for Master bit is set). The MSR is guaranteed to return the 80 hex value within 2.5  $\mu\text{s}$  after a hardware or software reset. All other user addressable registers other than the Main Status Register and Data Register (FIFO) can be accessed at any time, even while the part is in reset.

## 6.0 Device Description

### Absolute Maximum Ratings

(Notes 2 and 3)

If Military/Aerospace specified devices are required, please contact the National Semiconductor Sales Office/Distributors for availability and specifications.

Supply Voltage ( $V_{CC}, V_{CCA}$ )	-0.5V to +7.0V
Supply Differential ( $ V_{CC} - V_{CCA} $ )	0.6V
Input Voltage ( $V_i$ )	-0.5V to $V_{CC} + 0.5V$
Output Voltage ( $V_o$ )	-0.5V to $V_{CC} + 0.5V$
Storage Temperature ( $T_{STG}$ )	-65°C to +165°C
Power Dissipation ( $P_D$ )	1W
Lead Temperature ( $T_L$ )	+260°C
Soldering (10 seconds)	

### Recommended Operating Conditions

	Min	Typ	Max	Unit
Supply Voltage ( $V_{CC}$ )	4.5	5.0	5.5	V
Operating Temperature ( $T_A$ )	0		+70	°C
ESD Tolerance	2000			V
$C_{ZAP} = 100$ pF				
$R_{ZAP} = 1.5$ k $\Omega$				
(Note 1)				

### Capacitance $T_A = 25^\circ\text{C}, f = 1$ MHz

Symbol	Parameters	Min	Typ	Max	Units
$C_{IN}$	Input Pin Capacitance		5	7	pF
$C_{IN1}$	Clock Input Capacitance		8	10	pF
$C_{IO}$	I/O Pin Capacitance		10	12	pF
$C_O$	Output Pin Capacitance		6	8	pF

**Note 1:** Value based on test complying with NSC SOP5-028 human body model ESD testing using the ETS-910 tester.

**Note 2:** Absolute Maximum Ratings are those values beyond which damage to the device may occur.

**Note 3:** Unless otherwise specified all voltages are referenced to ground.

### 6.1 DC ELECTRICAL CHARACTERISTICS

**DC Characteristics** Under Recommended Operating Conditions

Symbol	Parameter	Conditions	Min	Typ	Max	Units
$V_{IH}$	Input High Voltage		2.0		$V_{CC}$	V
$V_{IL}$	Input Low Voltage		-0.5		0.8	V
$I_{CC}$	$V_{CC}$ Average Supply Current (Note 5)	$V_{IL} = 0.5V, V_{IH} = 2.4V$ No Loads on Outputs		10	15	mA
$I_{CCSB}$	$V_{CC}$ Quiescent Supply Current in Low Power Mode	$V_{IL} = V_{SS}$ $V_{IH} = V_{CC}$ No Loads on Outputs		0.500	2.0	mA
$I_{CCA}$	$V_{CCA}$ Average Supply Current (Note 5)	$V_{IL} = 0.5V$ $V_{IH} = 2.4V$ No Loads on Outputs		7	10	mA
$I_{CCASB}$	$V_{CCA}$ Quiescent Supply Current in Low Power Mode	$V_{IL} = V_{SS}$ $V_{IH} = V_{CC}$ No Loads on Outputs		5	50	$\mu\text{A}$
$I_{IL}$	Input Leakage Current (Note 4)	$V_{IN} = V_{CC}$ $V_{IN} = V_{SS}$			10 -10	$\mu\text{A}$ $\mu\text{A}$

#### OSCILLATOR PIN (XTAL1/CLK)

$I_{OSC}$	XTAL1 Input Current	$V_{IN} = V_{DD}$ or GND	$\pm 400$			$\mu\text{A}$
$V_{IH}$	XTAL1 Input High Voltage		2.0			V
$V_{IL}$	XTAL1 Input Low Voltage				0.8	V

**Note 4:** The MFM pin is rated for 10  $\mu\text{A}$ , -150  $\mu\text{A}$  because of an internal pull-up resistor.

**Note 5:** 500 kb/s read of "DB6" pattern.

## 6.0 Device Description (Continued)

### DC Characteristics Under Recommended Operating Conditions (Continued)

Symbol	Parameter	Conditions	Min	Typ	Max	Units
<b>MICROPROCESSOR INTERFACE PINS</b> (D7–D0, A2–A0, $\overline{CS}$ , $\overline{RD}$ , $\overline{WR}$ , INT, DRQ, $\overline{DACK}$ , TC, RESET)						
$V_{OH}$	Output High Voltage	$I_{OH} = -4 \text{ mA}$	3.0			V
$V_{OL}$	Output Low Voltage	$I_{OL} = 12 \text{ mA}$			0.4	V
$I_{OZ}$	Input TRI-STATE Leakage Current (D7–D0, INT, DRQ)	$V_{IN} = V_{CC}$ $V_{IN} = 0$			10 –10	$\mu\text{A}$ $\mu\text{A}$
<b>DISK INTERFACE PINS</b>						
$V_H$	Input Hysteresis			250		mV
$V_{OH}$	Output High Voltage (Note 5)	$I_{OH} = -4 \text{ mA}$	3.0			V
$V_{OL}$	Output Low Voltage	$I_{OL} = 48 \text{ mA}$			0.4	V
$I_{LKG}$	Output High Leakage Current (Note 6)	$V_{IN} = V_{CC}$ $V_{IN} = 0\text{V}$			10 –10	$\mu\text{A}$ $\mu\text{A}$
<b>MISCELLANEOUS PINS</b>						
$V_{OH}$	Output High Voltage (DRATE0–1, MFM)	$I_{OH} = -4 \text{ mA}$	3.0			V
$V_{OL}$	Output Low Voltage (DRATE0–1)	$I_{OL} = 6 \text{ mA}$			0.4	V
$V_{OL}$	Output Low Voltage (MFM)	$I_{OL} = 4 \text{ mA}$			0.4	V

**Note 5:**  $V_{OH}$  for the disk interface pins is valid for CMOS buffered outputs only.

**Note 6:** This parameter is valid for Open Drain output configuration only.

### 6.2 PHASE LOCKED LOOP CHARACTERISTICS

Parameter	Symbol	Conditions	Min	Typ	Max	Units
Dynamic Window Margin	$T_{DW}$	(Note)	68	73		%

**Note:** Dynamic window margin is tested at both  $V_{CC}$  extremes with a repeating "DB6" pattern and 0% MSV. 500 kb/s, 300 kb/s, 250 kb/s and 1 Mb/s are tested at 68%.

## 6.0 Device Description (Continued)

### 6.2 AC ELECTRICAL CHARACTERISTICS

6.2.1. AC Test Conditions  $T_A = 0^\circ\text{C}$  to  $+70^\circ\text{C}$ ,  $V_{CC} = 5.0\text{V} \pm 10\%$

#### Load Circuit

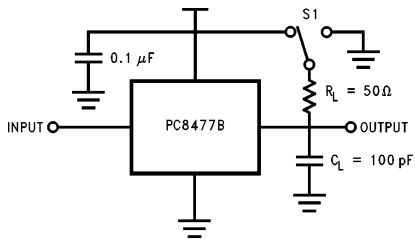

TL/F/11332-14

#### AC Testing Input, Output Waveform

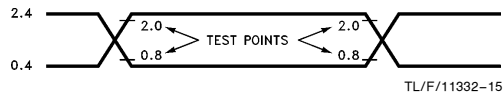

TL/F/11332-15

#### 6.2.2 Clock Timing

Symbol	Parameter	Min	Max	Units
$t_{CH}$	Clock High Pulse Width	16		ns
$t_{CL}$	Clock Low Pulse Width	16		ns
$t_{CP24}$	Clock Period	40	43	ns
$t_{ICP}$	Internal Clock Period (Table 6-1)			
$t_{DRP}$	Data Rate Period (Table 6-1)			

TABLE 6-1. Nominal  $t_{ICP}$ ,  $t_{DRP}$  Values

MFM Data Rate	$t_{DRP}$	$t_{ICP}$	Value	Units
1 Mb/s	1000	$3 \times t_{CP}$	125	ns
500 kb/s	2000	$3 \times t_{CP}$	125	ns
300 kb/s	3333	$5 \times t_{CP}$	208	ns
250 kb/s	4000	$6 \times t_{CP}$	250	ns

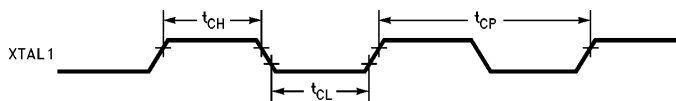

TL/F/11332-16

FIGURE 6-1. Clock Timing



## 6.0 Device Description (Continued)

### 6.2.3 Microprocessor Read Timing

Symbol	Parameter	Min	Max	Units
$t_{AR}$	Address Setup to Read Active	5		ns
$t_{RR}$	Read Active Pulse Width	60		ns
$t_{RA}$	Address Hold from Read Inactive	0		ns
$t_{RD}$	Data Valid from Read Active		45	ns
$t_{RH}$	Read Inactive Pulse Width	45		ns
$t_{DF}$	Data Output Float Delay		25	ns
$t_{RI}$	Interrupt Delay from Read Inactive		55	ns
$t_{DH}$	Data Output Hold from Read Inactive	5		ns

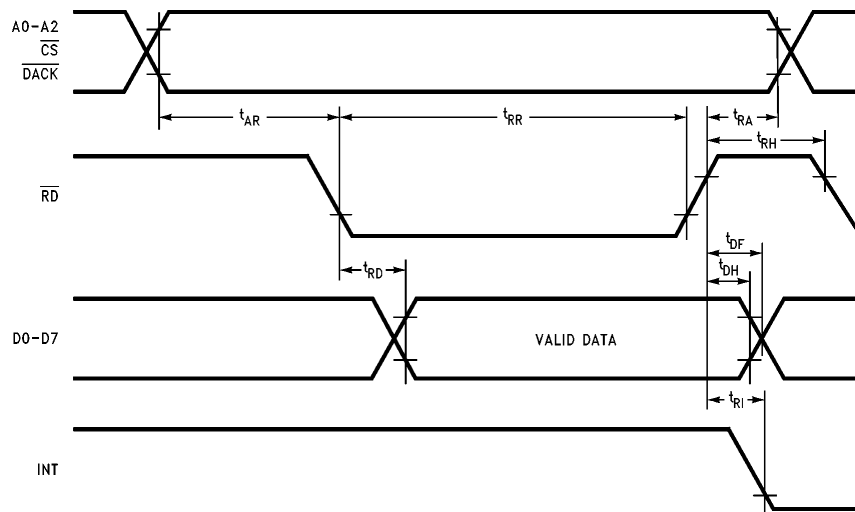

FIGURE 6-2. Microprocessor Read Timing

TL/F/11332-17

## 6.0 Device Description (Continued)

### 6.2.4 Microprocessor Write Timing

Symbol	Parameter	Min	Max	Units
$t_{AW}$	Address Setup to Write Active	5		ns
$t_{WW}$	Write Active Pulse Width	60		ns
$t_{WA}$	Address Hold from Write Inactive	0		ns
$t_{WH}$	Write Inactive Pulse Width	45		ns
$t_{ADW}$	Address Setup to Write Inactive	65		ns
$t_{DW}$	Data Setup to Write Inactive	30		ns
$t_{WD}$	Data Hold from Write Inactive	0		ns
$t_{WI}$	Interrupt Delay from Write Inactive		55	ns

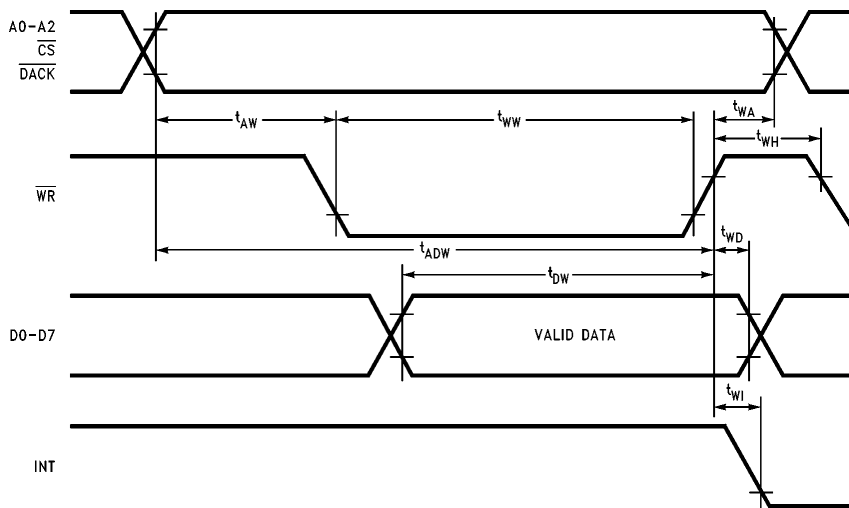

FIGURE 6-3. Microprocessor Write Timing

TL/F/11332-18

## 6.0 Device Description (Continued)

### 6.2.5 DMA Timing

Symbol	Parameter	Min	Max	Units
$t_{QP}$	DRQ Period (Except Non-Burst DMA) (Note 8)	$8 \times t_{DRP}$		$\mu\text{s}$
$t_{QQ}$	DRQ Inactive Non-Burst Pulse Width	300	400	ns
$t_{KQ}$	$\overline{\text{DACK}}$ Active Edge to DRQ Inactive		65	ns
$t_{RQ}$	$\overline{\text{RD}}, \overline{\text{WR}}$ Active Edge to DRQ Inactive (Note 7)		65	ns
$t_{QR}$	DRQ to $\overline{\text{RD}}, \overline{\text{WR}}$ Active	15		ns
$t_{TT}$	TC Active Pulse Width	50		ns
$t_{TQ}$	TC Active Edge to DRQ Inactive (Note 9)		75	ns
$t_{KK}$	$\overline{\text{DACK}}$ Active Pulse Width	65		ns
$t_{KI}$	$\overline{\text{DACK}}$ Inactive Pulse Width	25		ns
$t_{KR}$	$\overline{\text{DACK}}$ Setup to $\overline{\text{RD}}, \overline{\text{WR}}$ Active	5		ns
$t_{RK}$	$\overline{\text{DACK}}$ Hold from $\overline{\text{RD}}, \overline{\text{WR}}$ Inactive	0		ns
$t_{QW}$	DRQ to End of $\overline{\text{RD}}, \overline{\text{WR}}$ (Note 8) (DRQ Service Time)		$(8 \times t_{DRP}$ $- 16 \times t_{ICP})$	$\mu\text{s}$
$t_{QT}$	DRQ to TC Active (Note 8) (DRQ Service Time)		$(8 \times t_{DRP}$ $- 16 \times t_{ICP})$	$\mu\text{s}$

**Note 7:** The active edge of  $\overline{\text{RD}}$  or  $\overline{\text{WR}}$  is recognized only when  $\overline{\text{DACK}}$  is active.

**Note 8:** Values shown are with the FIFO disabled, or with FIFO enabled and THRESH = 0. For nonzero values of THRESH, add  $(\text{THRESH} \times 8 \times t_{DRP})$  to the values shown.

**Note 9:** During normal DMA operation TC should occur when  $\overline{\text{DACK}}$  is active during the last byte of the last sector transferred.

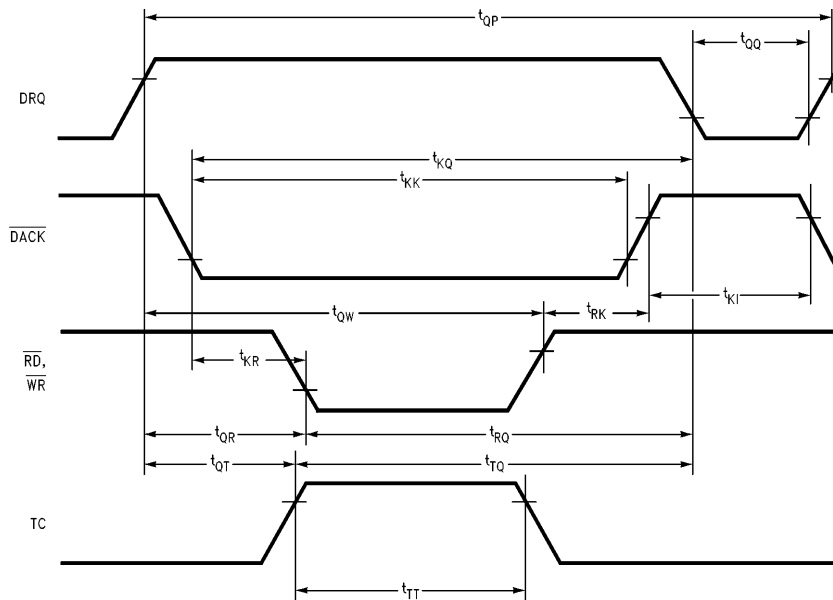

FIGURE 6-4. DMA Timing

TL/F/11332-19

## 6.0 Device Description (Continued)

### 6.2.6 Reset Timing

Symbol	Parameter	Min	Max	Units
$t_{RW}$	Reset Width (Note 10)	100		ns
$t_{RC}$	Reset to Control Inactive		300	ns

**Note 10:** The software reset pulse width is 100 ns. The hardware reset pulse width with an external 10 k $\Omega$  pull-up or pull-down resistor on the MFM pin is 100 ns. When using the internal pull-up resistor on the MFM pin, the hardware reset pulse width is 170 ns (assumes no load on MFM).

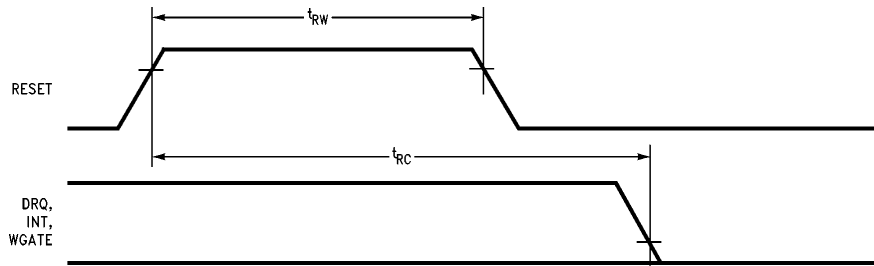

FIGURE 6-5. Reset Timing

TL/F/11332-20

### 6.2.7 Write Data Timing

Symbol	Parameter	Min	Max	Units
$t_{WDW}$	Write Data Pulse Width	Table 6-2		ns
$t_{HDS}$	HDSEL Setup to WGATE Active	100		$\mu$ s
$t_{HDH}$	HDSEL Hold from WGATE Inactive	750		$\mu$ s

TABLE 6-2. Minimum  $t_{WDW}$  Values

Data Rate	$t_{DRP}$	$t_{WDW}$	$t_{WDW}$ Value	Units
1 Mb/s	1000	$2 \times t_{ICP}$	250	ns
500 kb/s	2000	$2 \times t_{ICP}$	250	ns
300 kb/s	3333	$2 \times t_{ICP}$	375	ns
250 kb/s	4000	$2 \times t_{ICP}$	500	ns

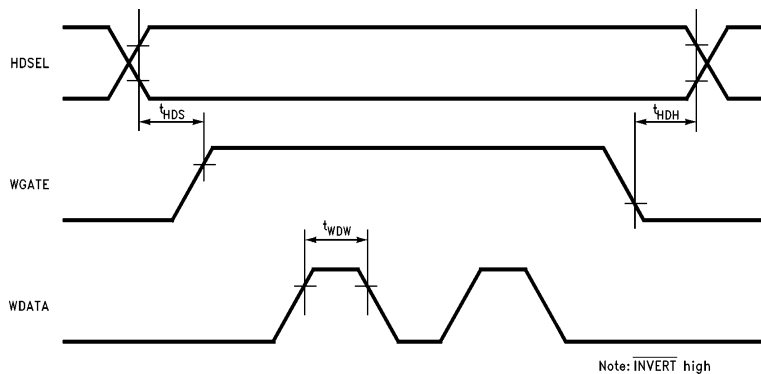

FIGURE 6-6. Write Data Timing

TL/F/11332-21

## 6.0 Device Description (Continued)

### 6.2.8 Drive Control Timing

Symbol	Parameter	Min	Max	Units
$t_{DRV}$	DR0–DR3, MTR0–MTR3 from End of $\overline{WR}$		100	ns
$t_{DST}$	DIR Setup to STEP Active	6		$\mu\text{s}$
$t_{STD}$	DIR Hold from STEP Inactive	$t_{SRT}$		ms
$t_{STP}$	STEP Active High Pulse Width	8		$\mu\text{s}$
$t_{SRT}$	STEP Rate Time (see Table 4-13)	1		ms
$t_{IW}$	Index Pulse Width	100		ns

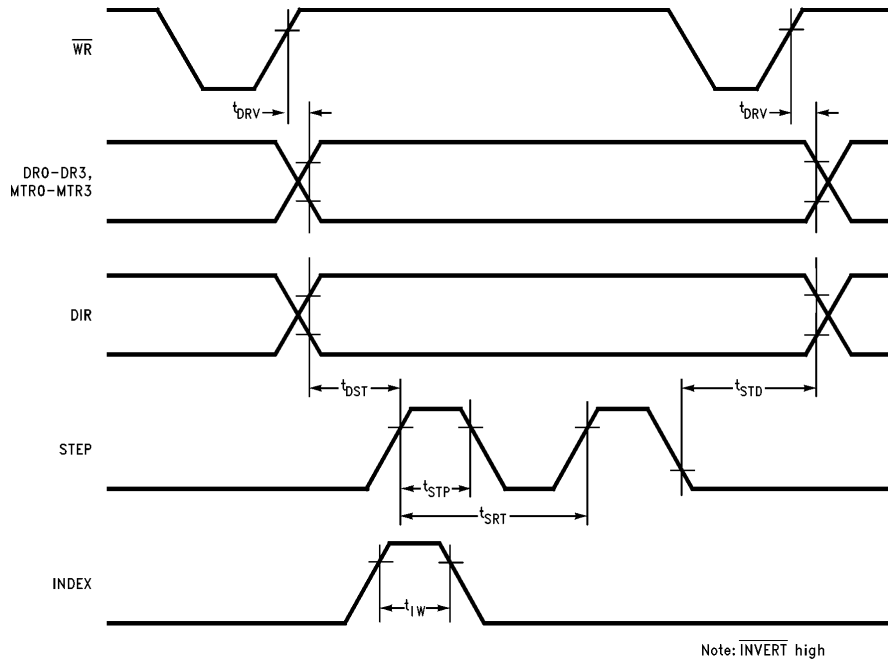

FIGURE 6-7. Drive Control Timing

TL/F/11332–22

### 6.2.9 Read Data Timing

Symbol	Parameter	Min	Max	Units
$t_{RDW}$	Read Data Pulse Width	50		ns

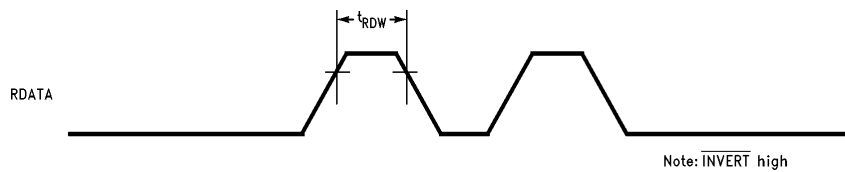

FIGURE 6-8. Read Data Timing

TL/F/11332–23

## 7.0 Reference Section

### 7.1 MNEMONIC DEFINITIONS FOR PC8477B COMMANDS

Symbol	Description
BFR	Buffer enable bit used in the Mode command. Enabled open-collector output buffers.
BST	Burst Mode disable control bit used in Mode command. Selects the Non-Burst FIFO mode if the FIFO is enabled.
DC0 DC1 DC2 DC3	Drive Configuration 0–3. Used to set a drive to conventional or perpendicular mode. Used in Perpendicular Mode command.
DENSEL	Density Select control bits used in the Mode command.
DIR	Direction control bit used in Relative Seek command to indicate step in or out.
DMA	DMA mode enable bit used in the Specify command.
DR0	Drive Select 0–1 bits used in most commands. Selects the logical drive.
DTL	Data Length parameter used in the Read, Write, Scan and Verify commands.
EC	Enable Count control bit used in the Verify command. When this bit is 1, the DTL parameter becomes SC (Sector Count).
EIS	Enable Implied Seeks. Used in the Configure command.
EOT	End of Track parameter set in the Read, Write, Scan, and Verify commands.
ETR	Extended Track Range used with the Seek command.
FIFO	First-In First-Out buffer. Also a control bit used in the Configure command to enable or disable the FIFO.
FRD	FIFO Read disable control bit used in the Mode command.
FWR	FIFO Write disable control bit used in the Mode command.
GAP	Gap2 control bit used in the Perpendicular Mode command.
HD	Head Select control bit used in most commands. Selects Head 0 or 1 of the disk.
IAF	Index Address Field control bit used in the Mode command. Enables the ISO Format during the Format command.
IPS	Implied Seek enable bit used in the Mode, Read, Write, and Scan commands.
LOCK	Lock enable bit in the Lock command. Used to make certain parameters unaffected by a software reset.
LOW PWR	Low Power control bits used in the Mode command.

Symbol	Description
MFM	Modified Frequency Modulation control bit used in the Read, Write, Format, Scan and Verify commands. Selects MFM or FM data encoding.
MFT	Motor Off Time programmed in the Specify command.
MNT	Motor On Time programmed in the Specify command.
MT	Multi-Track enable bit used in the Read, Write, Scan and Verify commands.
OW	Overwrite control bit used in the Perpendicular Mode command.
POLL	Enable Drive Polling bit used in the Configure command.
PRETRK	Precompensation Track Number used in the Configure command.
PTR	Present Track Register. Contains the internal track number for one of the four logical disk drives.
PU	Pump diagnostic enable bit used in the Mode command.
R255	Recalibrate control bit used in Mode command. Sets maximum recalibrate step pulses to 255.
RG	Read Gate diagnostic enable bit used in the Mode command.
RTN	Relative Track Number used in the Relative Seek command.
SC	Sector Count control bit used in the Verify command.
SK	Skip control bit used in read and scan operations.
SRT	Step Rate Time programmed in the Specify command. Determines the time between step pulses for seek and recalibrates.
ST0 ST1 ST2 ST3	Status Register 0–3. Contains status information about the execution of a command. Read in the Result Phase of some commands.
THRESH	FIFO threshold parameter used in the Configure command.
TMR	Timer control bit used in the Mode command. Affects the timers set in the Specify command.
WG	Write Gate control bit used in the Perpendicular Mode command.
WLD	Wildcard bit in the Mode command used to enable or disable the wildcard byte (FF) during Scan commands.

## 7.0 Reference Section (Continued)

### 7.2 PC8477B ENHANCEMENTS VS 82077AA

The enhancements listed below are additional functions of the PC8477B that the 82077AA does not have, and do not affect the compatibility between the two floppy controllers.

#### Commands

The following are PC8477B commands not supported by the 82077AA.

**Mode Command**—Controls several enhanced features of the PC8477B such as: Implied Seeks, Low Power mode, additional FIFO modes, and DENSEL encoding. The Mode command parameters are default to 82077AA compatible states, and will be unaffected by 82077AA-based software that does not recognize the existence of a Mode command. See the PC8477B data sheet for more details.

**NSC Command**—This one byte command is used to identify the PC8477B in the system. Other floppy controllers will return an 80 hex (invalid command), while the PC8477B will return a value of 73 hex (the lower four bits are reserved to indicate revision updates in the part).

**Set Track Command**—This command allows the user to program the value of any of the four Present Track Registers corresponding to the four logical drives.

#### FIFO Operation

The PC8477B FIFO is compatible with the 82077AA FIFO, with the addition of a Non-Burst mode. The default setting when the FIFO is enabled is the 82077AA compatible Burst mode. The Non-Burst mode is enabled via the Mode command. The Non-Burst mode will pulse the DRQ or INT signals during a burst transfer to or from the FIFO.

For both the Burst and Non-Burst modes with the FIFO enabled, no external circuitry is required with the PC8477B during DMA verify transfers. During verify operations, the DMA controller will assert the DACK signal without a  $\overline{RD}$  signal in response to a DRQ from the floppy controller. The 82077AA, however, requires external circuitry to create the  $\overline{RD}$  signal during DMA verify operations with its FIFO enabled in order to work successfully without an overrun error. The published Intel bug fix for the 82077AA can only be used for motherboard applications and not for add-in boards. The PC8477B does not have this problem.

Also, because of the byte counter in the PC8477B design, the DRQ or INT signal will be deasserted when the last byte of a sector is written to the FIFO during the execution phase of a write or format operation. The 82077AA does not deassert DRQ or INT until the last byte has been read out of the FIFO. This will cause a delay in the deassertion of DRQ or INT of up to 16 byte times, resulting in extra bytes transferred to the floppy controller. The PC8477B does not have this problem.

#### Data Separator

The PC8477B data separator's performance meets that of the 82077AA's. However, there are no dual modes in the PC8477B data separator whereas the 82077AA data separator has an internal floppy drive mode and an internal tape drive mode. This singular mode design of the PC8477B data separator eliminates the need for hardware or software control and provides for more consistent performance. The

PC8477B data separator is designed to work with the strictest motor speed and bit jitter requirements of both floppy and tape drives.

#### Low Power Mode

The typical measured low power current for the PC8477B (analog and digital) is 1 mA. The typical measured low power current for the 82077AA is 2 mA–3 mA.

The PC8477A supports the 82077AA manual low power mode by writing to the Low Power bit (D6) in the Data Rate Select register. The low power mode is turned off by issuing a reset to the chip, whereupon re-initialization is necessary. In addition, the PC8477B supports a manual low power AND automatic low power mode via the Mode command. Manual low power must be invoked every time the low power mode is desired. Automatic low power mode need only be invoked once during initialization, and then low power is entered whenever the floppy controller is idle.

As mentioned, the 82077AA and PC8477B will exit the low power mode after a reset. The PC8477B will also exit the low power mode after any read or write to the Main Status Register or Data Register. In this way, the part can exit low power cleanly without requiring additional software initialization. This feature gives the PC8477B an advantage in that once software has initialized it for automatic low power, no additional software modifications are necessary, and the chip will power down whenever it is idle. Even for manual low power mode via the DSR or Mode command, the PC8477B can return to normal mode without re-initialization, as required for the 82077.

#### Reset Pulse Width

The PC8477B software reset pulse width is 100 ns minimum. This means that software can issue two consecutive writes to the Digital Output Register of the PC8477B to toggle the Reset Controller bit (D2) without intervening delay. This specification is significantly better than the 82077AA minimum software reset pulse width, which is specified as 3.5  $\mu$ s (worst case at the 250 kb/s data rate).

When using an external pull-up or pull-down 10 k $\Omega$  resistor on the MFM pin, the hardware reset pulse width is also 100 ns minimum for the PC8477B. The minimum hardware reset pulse width for the 82077AA is 7.1  $\mu$ s. Again, the PC8477B specification is much better, allowing the system reset pulse to be very short.

#### Tape Drive Register

The PC8477B will support reads and writes to this register, just as the 82077AA does. However, the PC8477B will not use the information written to the Tape Drive Register to alter the state of the Data Separator. That is, there is only one mode of the internal PC8477B data separator, a high performance mode that will support the requirements for all floppy and tape drives.

#### Implied Seeks

The PC8477B supports our popular DP8473 method as well as the 82077AA method of implementing Implied Seeks. The DP8473 method is to set a bit in the Mode command for enabling Implied Seeks, and then set the Implied Seek bit if desired in the Read, Write, or Scan commands. The 82077AA method is to set the EIS bit (enable implied seeks) in the Configure command, and then Implied Seeks will always be enabled for Read, Write, and Verify commands.



## 7.0 Reference Section (Continued)

TABLE 7-1 8477B–82077 Parameter Comparison

Description	PC8477B	82077AA	82077SL	Units
<b>Absolute Maximum Ratings</b>				
Supply Voltage	–0.5–7.0	–0.5–8.0	–0.5–8.0	V
<b>DC Limits</b>				
V <sub>IH</sub> Clock MIN	2.0	3.9	3.9	V
I <sub>OL</sub> MFM pin (V <sub>OL</sub> = 0.4V)	4.0	2.5	2.5	mA
I <sub>OH</sub> MFM pin (V <sub>OH</sub> = 3.0V)	–4.0	–2.5	–2.5	mA
I <sub>CC</sub> Low Power (Analog + Digital) Typical	0.505	1.5	—	mA
I <sub>CC</sub> Low Power (Analog + Digital) Tested	2.05	no spec	—	mA
<b>AC Timings</b>				
t <sub>5</sub> (t <sub>ICP</sub> )–INTERNAL Clock Period				
1 Mb/s	125	125	125	ns
500 kb/s	125	250	250	ns
300 kb/s	208	420	420	ns
250 kb/s	250	500	500	ns
t <sub>6</sub> (t <sub>RR</sub> )–Read Active Pulse Width MIN	60	90	90	ns
t <sub>10</sub> (t <sub>RD</sub> )–Read to Valid Data	45	80	80	ns
t <sub>11</sub> (t <sub>RH</sub> )–Read Inactive Pulse Width	45	60	60	ns
t <sub>12</sub> (t <sub>DF</sub> )–Delay to Float	25	35	35	ns
t <sub>13</sub> (t <sub>RI</sub> )–Interrupt Delay from Read Inactive MAX				
1 Mb/s	55	250	250	ns
500 kb/s	55	375	375	ns
300 kb/s	55	545	545	ns
250 kb/s	55	625	625	ns
t <sub>16</sub> (t <sub>WW</sub> )–Write Active Pulse Width MIN	60	90	90	ns
t <sub>19</sub> (t <sub>DW</sub> )–Data Setup to Write Active	30	70	70	ns
t <sub>18</sub> (t <sub>WH</sub> )–Write Inactive Pulse Width	45	60	60	ns
t <sub>ADW</sub> –Address Setup to Write Inactive MIN	65	no spec	no spec	ns
t <sub>21</sub> (t <sub>WI</sub> )–Interrupt Delay from Write Inactive				
1 Mb/s	55	250	250	ns
500 kb/s	55	375	375	ns
300 kb/s	55	545	545	ns
250 kb/s	55	625	625	ns
t <sub>22</sub> (t <sub>QP</sub> )–DRQ Cycle Period MIN	8	6.5	6.5	μs
t <sub>23</sub> (t <sub>KQ</sub> )– $\overline{\text{DACK}}$ Active to DRQ Inactive MAX	65	75	75	ns
t <sub>23a</sub> (t <sub>QK</sub> + t <sub>KK</sub> )–DRQ to $\overline{\text{DACK}}$ Inactive				
1 Mb/s	60	no spec	83	ns
500 kb/s	60	no spec	166	ns
300 kb/s	60	no spec	280	ns
250 kb/s	60	no spec	333	ns
t <sub>24</sub> (t <sub>RQ</sub> )– $\overline{\text{RD}}$ , $\overline{\text{WR}}$ Active to DRQ Inactive MAX	65	100	100	ns
t <sub>27</sub> (t <sub>QR</sub> )–DRQ to $\overline{\text{RD}}$ , $\overline{\text{WR}}$ Active MIN	15	0	0	ns
t <sub>29</sub> (t <sub>TQ</sub> )–TC Active to DRQ Inactive MAX	75	150	150	ns
t <sub>KK</sub> – $\overline{\text{DACK}}$ Active Pulse Width MIN	65	no spec	no spec	ns
t <sub>KI</sub> – $\overline{\text{DACK}}$ Inactive Pulse Width MIN	25	no spec	no spec	ns
t <sub>QK</sub> –DRQ to $\overline{\text{DACK}}$ Active MIN	10	no spec	no spec	ns
t <sub>30</sub> (t <sub>RW</sub> )–Reset Pulse Width MIN	100	7083	7083	ns
t <sub>30a</sub> (t <sub>RW</sub> )–Software Reset Pulse Width MIN (Worst Case)	100	3500	500	ns
t <sub>31</sub> (t <sub>RC</sub> )–Reset to Control Inactive	160	2000	2000	ns
t <sub>32</sub> (t <sub>WDW</sub> )–Write Data Pulse Width MIN				
1 Mb/s	250	150	150	ns
500 kb/s	250	360	360	ns
300 kb/s	416	615	615	ns
250 kb/s	500	740	740	ns

## 7.0 Reference Section (Continued)

TABLE 7-1 8477B–82077AA Parameter Comparison (Continued)

Description	PC8477B	82077AA	82077SL	Units
<b>AC Timings (Continued)</b>				
t <sub>35</sub> (t <sub>DST</sub> )–DIR Setup to STEP Active MIN	6	4	4	μs
t <sub>36</sub> (t <sub>STD</sub> )–DIR Hold from STEP Inactive MIN	t <sub>SRT</sub>	10	10	μs
t <sub>37</sub> (t <sub>STP</sub> )–STEP Active Pulse Width	8	2.5	2.5	μs
t <sub>39</sub> (t <sub>W</sub> )–Index Pulse Width MIN				
1 Mb/s	100	625	625	ns
500 kb/s	100	1250	1250	ns
300 kb/s	100	2100	2100	ns
250 kb/s	100	2500	2500	ns
t <sub>41</sub> (t <sub>HDH</sub> )–HDSEL Hold from WGATE Inactive MIN				
1 Mb/s	*750	716	716	μs
500 kb/s	*750	1432	1432	μs
300 kb/s	*750	2719	2719	μs
250 kb/s	*750	2864	2864	μs
t <sub>HDS</sub> –HDSEL Setup to WGATE Active	*100	no spec	no spec	μs

\*These timings are required to support perpendicular recording drives.

## 7.0 Reference Section (Continued)

### 7.3 PC8477B INTERFACE IN A PC-AT

The PC8477B interface to the PC-AT bus is simple and requires only an external address decoder. All the microprocessor inputs and outputs of the PC8477B can be connected directly to the peripheral bus due to the 12 mA sink capability. Figure 7-1 shows the interface with the floppy drive header, and the signal connections to the AT bus. The design will support 1.2 Meg, 1.44 Meg, and 2.88 Meg drives. Support for the 2.88 Meg perpendicular drives is accomplished with the additional density encoding signal (DRATE0) on floppy header pin 6. This interface solution will support perpendicular drives with the encoding scheme listed in Table 7-2 below.

TABLE 7-2. Density Encoding

Media	Data Rate	HD	ED
1 Meg	250 kb/s	0	0
2 Meg	500 kb/s	1	0
4 Meg	1 Mb/s	X	1

The HD signal is floppy header pin 2, and the ED signal is header pin 6. This standard scheme is supported by a number of perpendicular drive manufacturers. Some new perpendicular drives are using an auto media sense for density selection. These drives will not require either the HD or ED signals. Here the data rate is determined optically by the drive due to the hole in the disk.

The only use of the 16L8 PAL is address decoding for the proper floppy address range. The primary range is 3F0–3F7 while the secondary address range is 370–377. Selection between can be accomplished with a jumper if needed. The address lines A9–A3 and AEN are input to the PAL from the peripheral bus. The following equation can be used for the primary range.

$$\overline{CS} = !(AEN * A9 * A8 * A7 * A6 * A5 * A4 * !A3)$$

In this design we have used 1 kΩ pull-up resistors on the floppy drive interface. If the intended design is to be used with external drives or long cabling, or if 5.25" disk drives are to be supported, 150 kΩ pull-ups should be considered.

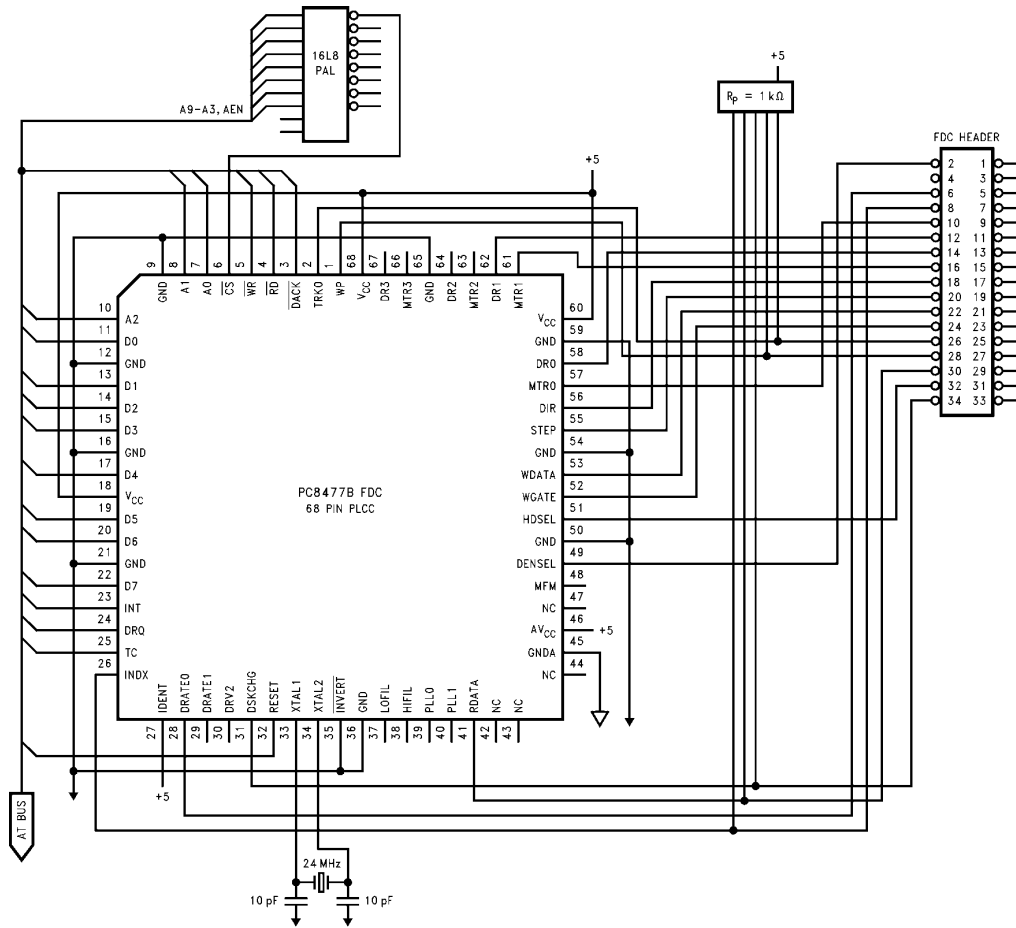

FIGURE 7-1. 8477B in PC-AT System

TL/F/11332-24

## 7.0 Reference Section (Continued)

### 7.4 SOFTWARE INITIALIZATION SEQUENCE

Following power up the system will issue a hardware reset to the PC8477B. This will put the internal registers and circuitry into a known state after which the software initialization sequence can begin.

**End Reset**—The first task is to bring the PC8477B out of the reset state by writing 0CH to the DOR register. The software should then poll the MSR until 80H is returned. At this point the controller is ready to begin processing commands.

**Service Ready Changed State Interrupt**—Once an interrupt is received the software should issue 4 SENSE INTERRUPT commands for each of the 4 logical drives. This is due to the fact that after a reset, drive polling is enabled by default.

**Set Data Rate**—The data rate should be set via a write to the CCR register. The default state is 250 kb/s following reset.

**Configure the FIFO**—The default setting is with the FIFO disabled. If the perpendicular format is to be supported the FIFO will need to be enabled due to the higher data rates used. The FIFO threshold level should be set based on the DMA response time of the system. A lower value of THRESH corresponds to a fast system with a quick DMA response time, whereas a higher value of THRESH corresponds to a sluggish system with slower DMA response time. A write to the configuration register is also used to enable implied seeks if that feature is desired.

**Lock**—This command will lock the FIFO parameters which will leave them unaffected following a reset. Set the LOCK bit to 1 to lock the parameters.

**Specify Command**—After a reset a specify command must always be issued in the initialization sequence. This is because there is no default for these values. With this command you will set up the motor on and motor off times as well as the step rate times. DMA mode is also enabled via this command.

**Mode Command**—There are several advanced features that can be enabled via the mode command. Head settling time for implied seeks, open collector drive interface outputs, ISO format pattern, low power modes, enabling 255 step pulses for higher density media, and FIFO burst mode are just some of the features.

**Recalibrate Drive**—First access to the drive should be to RECALIBRATE to track 0. Following the recalibrate command it is necessary to issue a SENSE INTERRUPT command to determine if the recalibrate was successful. If no track 0 was detected, an error will be reported. This is a common method to determine if a drive is connected.

**Seek/Read/Write/Format**—At this point the initialization is complete and normal disk I/O operations would start to occur. In normal operations it would not be necessary to re-initialize prior to each access. Normal disk I/O operations would include writes to CCR register to change data rates, recalibrating to track 0, toggling the motor and drive selects through the DOR register, seeking to the appropriate track, and initializing the DMA controller prior to Read/Write/Format commands.

Figure 7-2 shows a block diagram representing the initialization sequence for the PC8477B.

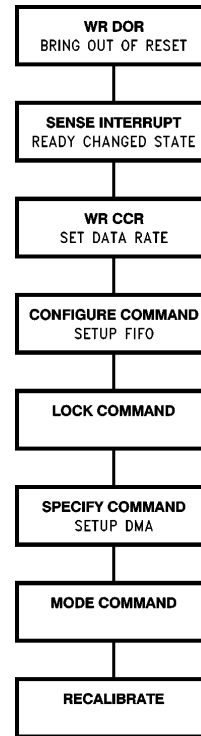

TL/F/11332-25

FIGURE 7-2. PC8477B Initialization

### 7.5 PC8477A/PC8477B DIFFERENCES

There are two differences to note between the 8477A and 8477B versions. The **NSC command** result phase returns a 73H in the 8477B, and returns a 72H in the 8477A. This command is used strictly to distinguish new revisions of the part. The second difference pertains to the Motor On Time (MNT) values when the FDC is in Mode 1. The new table is listed in Table 4-15 of this document. The MNT values at 500 kb/s for Mode 1 were changed to be the same as the 1 Mb/s values. The changes to the MNT values should not affect application software.

### 7.6 REVISION HISTORY

Nov. 1990 Preliminary PC8477 datasheet  
May 1992 Preliminary PC8477B datasheet

- Add new part markings
- Add PQFP package option
- Add 1.25 Mb/s data rate support
- Add Dynamic Window Margin spec.
- Improve ICC and AC databus timings
- Add applications reference section

June 1993 Final PC8477B datasheet

- Elimination of 1.25 Mb/s data rate support
- Elimination of FM mode functional testing
- ESD tolerance spec. raised to 2000V
- Replace  $t_{QK}$  spec. with  $t_{KR}$  and  $t_{RK}$
- Change  $t_{RC}$  spec. from 160 ns to 300 ns
- Change  $t_{WDW}$  @300 Kb/s from 416 ns to 375 ns



**Physical Dimensions** inches (millimeters)

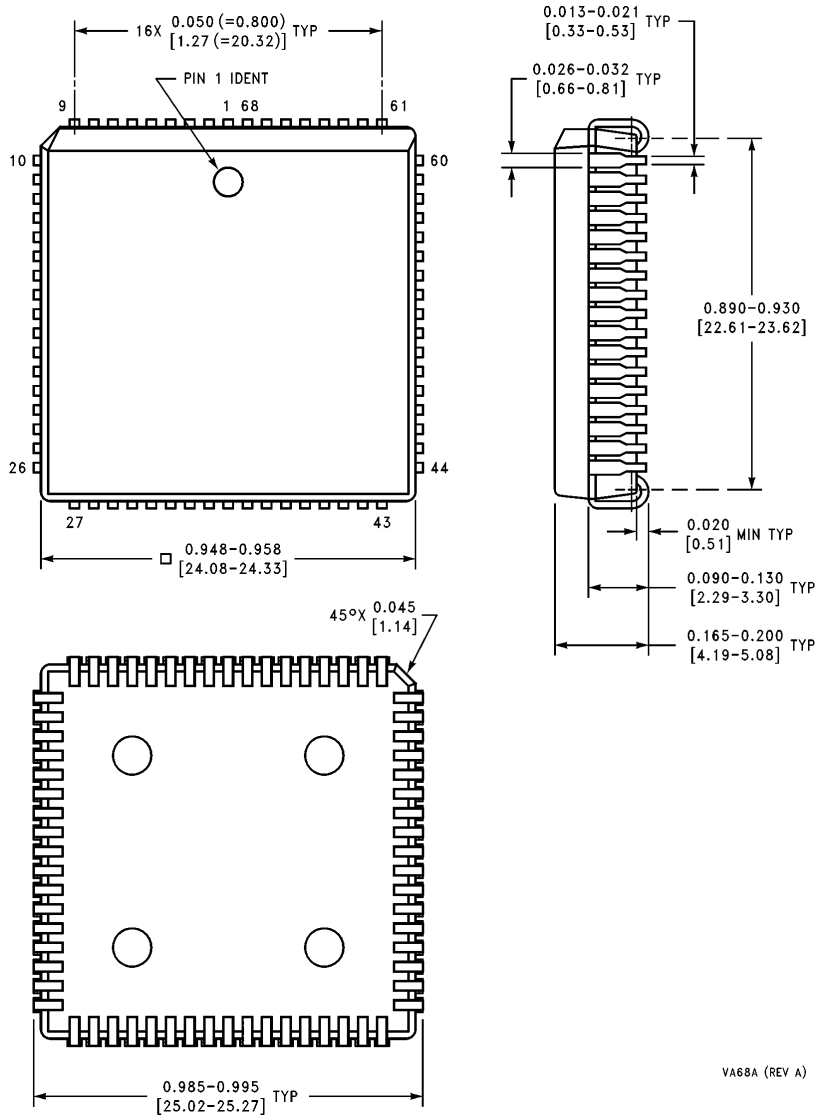

VA68A (REV A)

**Plastic Chip Carrier (V)**  
**Order Number PC8477BV-1**  
**NS Package Number VA68A**

**Physical Dimensions** inches (millimeters) (Continued)

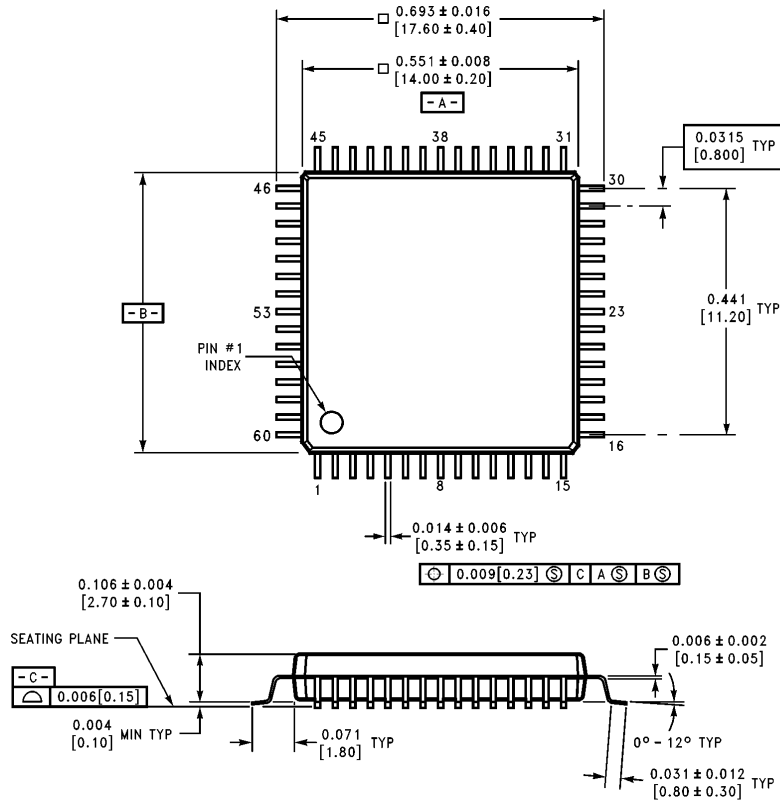

**Plastic Quad Flat Package (PQFP)**  
**Order Number PC8477BVF-1**  
**NS Package Number VF60A**

VF60A (REV A)

**LIFE SUPPORT POLICY**

NATIONAL'S PRODUCTS ARE NOT AUTHORIZED FOR USE AS CRITICAL COMPONENTS IN LIFE SUPPORT DEVICES OR SYSTEMS WITHOUT THE EXPRESS WRITTEN APPROVAL OF THE PRESIDENT OF NATIONAL SEMICONDUCTOR CORPORATION. As used herein:

1. Life support devices or systems are devices or systems which, (a) are intended for surgical implant into the body, or (b) support or sustain life, and whose failure to perform, when properly used in accordance with instructions for use provided in the labeling, can be reasonably expected to result in a significant injury to the user.
2. A critical component is any component of a life support device or system whose failure to perform can be reasonably expected to cause the failure of the life support device or system, or to affect its safety or effectiveness.



**National Semiconductor Corporation**  
 2900 Semiconductor Drive  
 P.O. Box 58090  
 Santa Clara, CA 95052-8090  
 Tel: (800) 272-9959  
 TWX: (910) 339-9240

**National Semiconductor GmbH**  
 Livny-Gargan-Str. 10  
 D-82256 Fürstenfeldbruck  
 Germany  
 Tel: (81-41) 35-0  
 Telex: 527849  
 Fax: (81-41) 35-1

**National Semiconductor Japan Ltd.**  
 Sumitomo Chemical  
 Engineering Center  
 Bldg. 7F  
 1-7-1, Nakase, Mihama-Ku  
 Chiba-City,  
 Chiba Prefecture 261  
 Tel: (043) 299-2300  
 Fax: (043) 299-2500

**National Semiconductor Hong Kong Ltd.**  
 13th Floor, Straight Block,  
 Ocean Centre, 5 Canton Rd.  
 Tsimshatsui, Kowloon  
 Hong Kong  
 Tel: (852) 2737-1600  
 Fax: (852) 2736-9960

**National Semicondutores Do Brazil Ltda.**  
 Rue Deputado Lacorda Franco  
 120-3A  
 Sao Paulo-SP  
 Brazil 05418-000  
 Tel: (55-11) 212-5066  
 Telex: 391-1131931 NSBR BR  
 Fax: (55-11) 212-1181

**National Semiconductor (Australia) Pty. Ltd.**  
 Building 16  
 Business Park Drive  
 Monash Business Park  
 Nottingham, Melbourne  
 Victoria 3168 Australia  
 Tel: (3) 558-9999  
 Fax: (3) 558-9998

National does not assume any responsibility for use of any circuitry described, no circuit patent licenses are implied and National reserves the right at any time without notice to change said circuitry and specifications.