

229/230 Series 2AG, Slo-Blo® Fuse with Indicating Option







Description

Littelfuse 229/230 series Slo-Blo® Fuses are available in 2AG size cartridge or axial lead form, offer tripped fuse indicating option, and offer features designed to meet rigorous Telecom industry requirements.

229/230 series product ordered with the tripped fuse indicating option show discoloration of the glass body immediately after trip. They offer the same performance characteristics as standard product, and help to reduce time locating the tripped fuse and troubleshooting circuit issues.

The 229/230 series 0.25A - 1.25A range combines conventional overcurrent protection with ability to withstand high current, short duration pulses which complies to short circuit requirements of UL 1459 for telephone equipment. Insulating sleeve option is also available. Please refer to the Surge Withstand Specifications section of this document for additional information.

Agency Approvals

Agency	Agency File Number	Ampere Range
	E10480	250mA - 3.5A
	LR 29862	250mA - 7A
	E10480	4A - 7A
	NBK200405 - E10480C/D NBK110512 - E10480A/B NBK210405 - E10480E/F	1A - 3.5A 4A - 5A 6A - 7A
		250mA - 7A

Electrical Characteristics for Series

% of Ampere Rating	Opening Time
100%	4 hours, Minimum
135%	1 hour, Maximum
200%	3 seconds, Minimum
	20 seconds, Maximum

Features

- Available in cartridge and axial lead form, and a wide range of lead forming dimension and packaging options
- In accordance with UL Standard 248-14
- RoHS compliant and Lead-free
- Tripped fuse indicating option (add suffix 'S' to part number)
- Fuses are available for board washable with the additional sealing process (add suffix 'A' to part number)
- Sleeved fuse option available (contact Littelfuse for additional information)

Additional Information



Datasheet
229 Series



Resources
229 Series



Samples
229 Series



Datasheet
230 Series



Resources
230 Series



Samples
230 Series

Electrical Characteristic Specification by Item

Amp Code	Ampere Rating (A)	Voltage Rating (V)	Interrupting Rating	Nominal Cold Resistance (Ohms)	Nominal Melting I ² t (A ² sec)	Agency Approvals				
						UL	RU	PS E	SF	CE
.250	0.25	250	35A@250Vac 10KA@125Vac 10KA@125Vdc 80A@310Vac	2.4300	0.216	x			x	x
.350	0.35	250		1.3100	0.490	x			x	x
.375	0.375	250		1.1685	0.580	x			x	x
.500	0.5	250		0.6935	1.16	x			x	x
.600	0.6	250		0.4805	1.75	x			x	x
.750	0.75	250		0.3430	2.95	x			x	x
.800	0.8	250		0.3060	3.45	x			x	x
001.	1	250		0.2120	5.64	x		x	x	x
1.25	1.25	250	100A@250Vac 10KA@125Vac 10KA@125Vdc 80A@310Vac	0.1460	9.80	x		x	x	x
01.5	1.5	250		0.1077	15.0	x		x	x	x
002.	2	250		0.0698	30.0	x		x	x	x
2.25	2.25	250		0.0567	39.0	x		x	x	x
02.5	2.5	250		0.0502	50.0	x		x	x	x
003.	3	250		0.0383	77.0	x		x	x	x
03.5	3.5	250	100A@250Vac 10KA@125Vac 10KA@125Vdc	0.0312	110.0	x		x	x	x
004.	4	125	400A@125Vac 400A@125Vdc	0.0258	148.0		x	x	x	x
005.	5	125		0.0186	267		x	x	x	x
006.	6	125		0.0141	380		x	x	x	x
007.	7	125		0.0116	464		x	x	x	x

Surge Withstand Specifications

Peak Withstand Current(I_p): These fuses will withstand 50 repetitions of a double exponential impulse wave having peak currents(I_p) and peak voltages as listed.

Amp Code	Ampere Rating (A)	Interrupting Rating	Nominal Cold Resistance (Ohms)	Nominal Melting I ² t (A ² sec)	10x160 μs 1500V	10x560 μs 800V	10x1000 μs 1000V
.250	0.25	60A@600Vac 40A@600Vac 7A@600Vac 2.2A@600Vac	2.4300	0.216	23.0A	16.6A	12.4A
.350	0.35		1.3100	0.490	34.0A	25.8A	19.3A
.375	0.375		1.1685	0.580	40.0A	25.4A	19.0A
.500	0.5		0.6935	1.16	60.0A	37.7A	28.2A
.600	0.6		0.4805	1.75	71.0A	47.2A	35.3A
.750	0.75		0.3430	2.95	91.0A	65.5A	49.0A
.800	0.8		0.3060	3.45	104.0A	68.9A	51.6A
001.	1		0.2120	5.64	130A	88.6A	66.3A
1.25	1.25*		0.1460	9.80	162.0A	118.1A	100.0A

* 500A peak, 2500V, 2x10 microseconds, 20 repetitions

Temperature Derating Curve

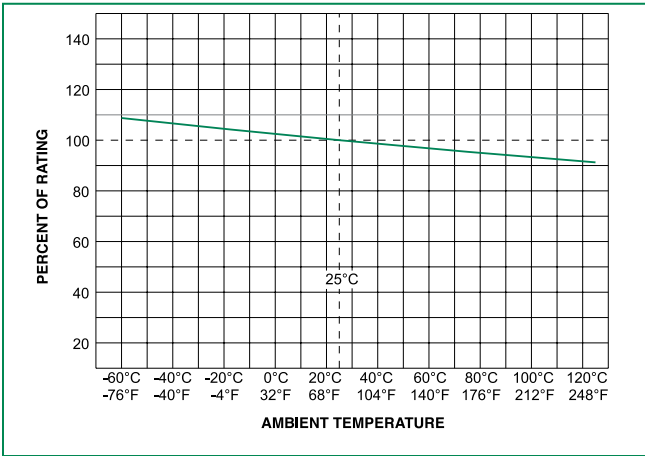

Average Time Current Curves

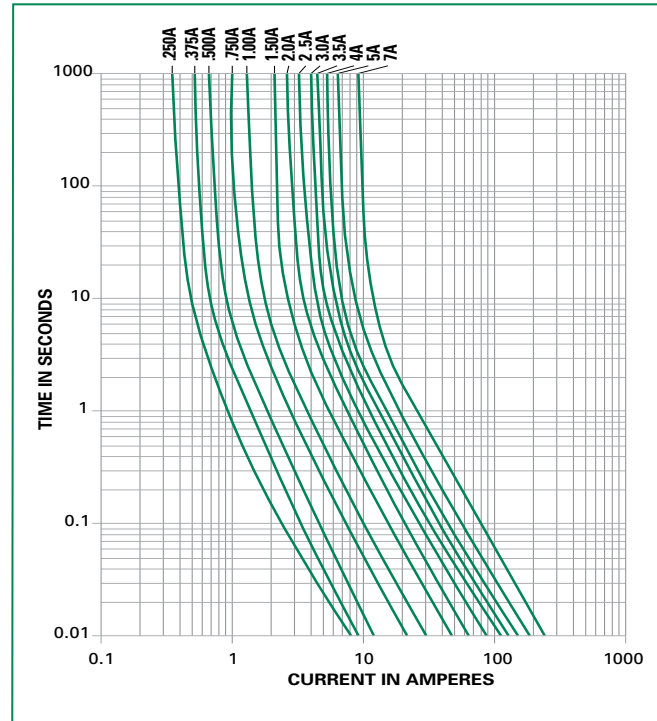

Soldering Parameters - Wave Soldering

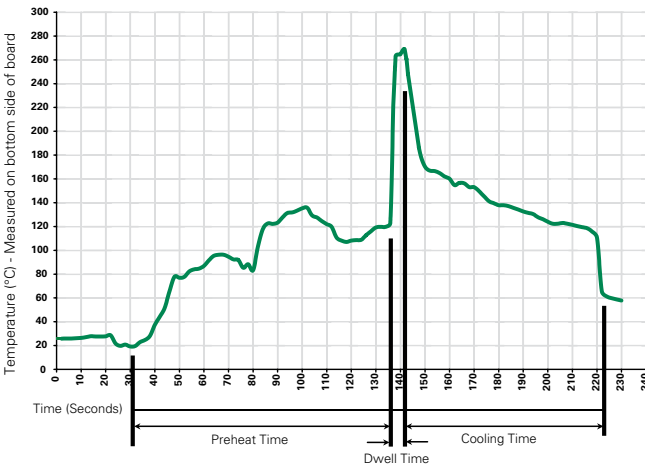

Recommended Process Parameters:

Wave Parameter	Lead-Free Recommendation
Preheat: (Depends on Flux Activation Temperature)	(Typical Industry Recommendation)
Temperature Minimum:	100° C
Temperature Maximum:	150° C
Preheat Time:	60-180 seconds
Solder Pot Temperature:	260° C Maximum
Solder Dwell Time:	2-5 seconds

Recommended Hand-Solder Parameters:

- Solder Iron Temperature: 350° C +/- 5° C
- Heating Time: 5 seconds max.

Note: These devices are not recommended for IR or Convection Reflow process.

Product Characteristics

Materials	Body: Glass Cap: Nickel-plated brass Leads: Tin-plated Copper
Terminal Strength	MIL-STD-202G, Method 211A, Test Condition A
Solderability	Reference IEC 60127 Second Edition 2003-01 Annex A
Product Marking	Cap1: Brand logo, current and voltage ratings Cap2: Series and agency approval marks

Operating Temperature	-55°C to +125°C
Thermal Shock	MIL-STD-202G, Method 107G, Test Condition B: (5 cycles -65°C to 125°C)
Vibration	MIL-STD-202G, Method 201A
Humidity	MIL-STD-202G, Method 103B, Test Condition A: High RH (95%) and Elevated temperature (40°C) for 240 hours
Salt Spray	MIL-STD-202G, Method 101D, Test Condition B

Dimensions

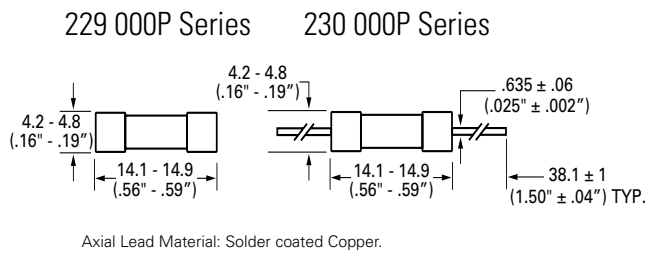

Part Numbering System

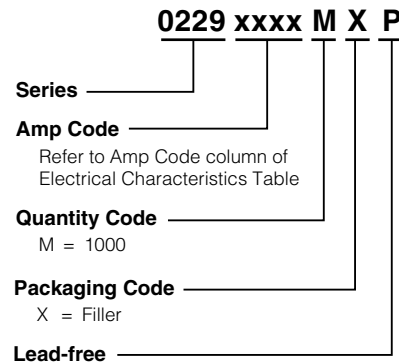

Packaging

Packaging Option	Packaging Specification	Quantity	Quantity & Packaging Code	Taping Width
229 Series				
Bulk	N/A	5	VX	N/A
Bulk	N/A	5	VXS	N/A
Bulk	N/A	100	HX	N/A
Bulk	N/A	100	HXS	N/A
Bulk	N/A	1000	MX	N/A
Bulk	N/A	1000	MXS	N/A
230 Series				
Bulk	N/A	5	VX	N/A
Bulk	N/A	5	VXS	N/A
Bulk	N/A	100	HX	N/A
Bulk	N/A	100	HXS	N/A
Bulk	N/A	1000	MX	N/A
Bulk	N/A	1000	MXE	N/A
Bulk	N/A	1000	MXF1	N/A
Bulk	N/A	1000	MXF16	N/A
Bulk	N/A	1000	MXF16O	N/A
Bulk	N/A	1000	MXF17	N/A
Bulk	N/A	1000	MXF17O	N/A
Bulk	N/A	1000	MXF23	N/A
Bulk	N/A	1000	MXF23O	N/A
Bulk	N/A	1000	MXF32	N/A
Bulk	N/A	1000	MXO	N/A
Bulk	N/A	1000	MXS	N/A
Reel and Tape	EIA 296-E	1500	DRT2	T2=63mm (2.500")
Reel and Tape	EIA 296-E	1500	DRT2S	T2=63mm (2.500")
Reel and Tape	EIA 296-E	1500	DRT4	N/A
Reel and Tape	EIA 296-E	2500	ERT2	T2=63mm (2.500")
Reel and Tape	EIA 296-E	2500	ERT2S	T2=63mm (2.500")
Reel and Tape	EIA 296-E	1000	MRT1E	T1=53mm (2.087")
Reel and Tape	EIA 296-E	1500	DAT1	T1=53mm (2.087")
Reel and Tape	EIA 296-E	1500	DAT1O	T1=53mm (2.087")
Reel and Tape	EIA 296-E	1500	DRT1	T1=53mm (2.087")
Reel and Tape	EIA 296-E	1500	DRT1S	T1=53mm (2.087")
Reel and Tape	EIA 296-E	1500	DRT1SS	T1=53mm (2.087")
Reel and Tape	EIA 296-E	1500	DRT3	T3=73mm (2.874")
Reel and Tape	EIA 296-E	1500	DRT3S	T3=73mm (2.874")
Reel and Tape	EIA 296-E	2500	ERT1	T1=53mm (2.087")
Reel and Tape	EIA 296-E	2500	ERT1S	T1=53mm (2.087")
Reel and Tape	EIA 296-E	2500	ERT3	T3=73mm (2.874")
Reel and Tape	EIA 296-E	2500	ERT3S	T3=73mm (2.874")