

AccuTouch®

Product Manual

Revision F

P/N 821615-000

Elo TouchSystems, Inc.

1-800-ELO TOUCH
www.elotouch.com

tyco

Electronics



**Copyright © 1988, 1992, 1994, 1995, 2001 by Elo TouchSystems, Inc.
All rights reserved.**

No part of this publication may be reproduced, transmitted, transcribed, stored in a retrieval system, or translated into any language or computer language, in any form or by any means, including, but not limited to, electronic, magnetic, optical, chemical, manual, or otherwise without prior written permission of Elo TouchSystems.

The information in this document is subject to change without notice. Elo TouchSystems makes no representations or warranties with respect to the contents hereof, and specifically disclaims any implied warranties of merchantability or fitness for a particular purpose. Elo TouchSystems reserves the right to revise this publication and to make changes from time to time in the content hereof without obligation of Elo TouchSystems to notify any person of such revisions or changes.

Trademark Acknowledgements

AccuTouch, IntelliTouch, DuraTouch, and MonitorMouse are registered trademarks, and ELODEV, TouchUp, TouchBack, SmartSet, and COACH are trademarks of Elo TouchSystems, Inc. All other trademarks are the property of their respective holders.

LIMITED WARRANTY

(a) Elo TouchSystems, Inc., ("Seller") warrants to Buyer that the Products (i) shall be free of defects in materials and workmanship for five (5) years from the date of shipment for touchscreen components and controllers (except COACH chip controller) and two (2) years from the date of shipment for TouchMonitors (each a "Warranty Period"), (ii) shall conform to Seller's specifications for such Products throughout the applicable Warranty Period, and (iii) shall be free of liens and encumbrances when shipped to Buyer. If Seller agrees in writing to provide and does provide system design, drawings, technical advice, or any other services to Buyer in connection with Products, then Seller further warrants to Buyer during the applicable Warranty Period that such services shall be undertaken in accordance with Seller's reasonable technical judgment based on Seller's understanding of pertinent technical data as of the date of performance of such services. Seller's warranties will not apply to any Product with respect to which there has been (i) improper installation or testing, (ii) failure to provide a suitable operating environment, (iii) use of the Product for purposes other than that for which it was designed, (iv) failure to monitor or operate in accordance with applicable Seller specifications and good industry practice, (v) unauthorized attachment or removal or alteration of any part, (vi) unusual mechanical, physical or electrical stress, (vii) modifications or repairs done by other than Seller, or (viii) any other abuse, misuse, neglect or accident. In no circumstance shall Seller have any liability or obligation with respect to expenses, liabilities or losses associated with the installation or removal of any Product or the installation or removal of any components for inspection, testing or redesign occasioned by any defect or by repair or replacement of a Product.

(b) Seller makes no warranty regarding the model life of monitors. Seller's suppliers may at any time and from time to time make changes in the monitors delivered as Products or components.

(c) Buyer shall notify Seller in writing promptly (and in no case later than thirty (30) days after discovery) of the failure of any Product to conform to the warranty set forth above, shall describe in commercially reasonable detail in such notice the symptoms associated with such failure, and shall provide to Seller the opportunity to inspect such Products as installed, if possible. The notice must be received by Seller during the Warranty Period for such Product. Unless otherwise directed in writing by Seller, within thirty (30) days after submitting such notice, Buyer shall package the allegedly defective Product in its original shipping carton(s) or a functional equivalent and shall ship it to Seller at Buyer's expense and risk.

(d) Within a reasonable time after receipt of the allegedly defective Product and verification by Seller that the Product fails to meet the warranty set forth above, Seller shall correct such failure by, at Seller's option, either (i) modifying or

repairing the Product or (ii) replacing the Product. Such modification, repair or replacement and the return shipment of the Product with minimum insurance to Buyer shall be at Seller's expense. Buyer shall bear the risk of loss or damage in transit, and may insure the Product. Buyer shall reimburse Seller for transportation costs incurred for Products returned but found by Seller not to be defective. Modification or repair of Products may, at Seller's option, take place either at Seller's facilities or at Buyer's premises. If Seller is unable to modify, repair or replace a Product to conform to the warranty set forth above, then Seller shall, at Seller's option, either refund to Buyer or credit to Buyer's account the purchase price of the Product less depreciation calculated on a straight-line basis over Seller's stated useful life of the Product (three years for touchscreen components and controllers and one year for TouchMonitors). THESE REMEDIES SHALL BE BUYER'S EXCLUSIVE REMEDIES FOR BREACH OF WARRANTY.

(e) EXCEPT FOR THE EXPRESS WARRANTY SET FORTH ABOVE, SELLER GRANTS NO OTHER WARRANTIES, EXPRESS OR IMPLIED, BY STATUTE OR OTHERWISE, REGARDING THE PRODUCTS, THEIR FITNESS FOR ANY PURPOSE, THEIR QUALITY, THEIR MERCHANTABILITY, THEIR NONINFRINGEMENT, OR OTHERWISE. NO EMPLOYEE OF SELLER OR ANY OTHER PARTY IS AUTHORIZED TO MAKE ANY WARRANTY FOR THE GOODS OTHER THAN THE WARRANTY SET FORTH HEREIN. SELLER'S LIABILITY UNDER THE WARRANTY SHALL BE LIMITED TO A REFUND OF THE PURCHASE PRICE OF THE PRODUCT. IN NO EVENT SHALL SELLER BE LIABLE FOR THE COST OF PROCUREMENT OR INSTALLATION OF SUBSTITUTE GOODS BY BUYER OR FOR ANY SPECIAL, CONSEQUENTIAL, INDIRECT OR INCIDENTAL DAMAGES.

(f) Buyer assumes the risk and agrees to indemnify Seller against and hold Seller harmless from all liability relating to (i) assessing the suitability for Buyer's intended use of the Products and of any system design or drawing and (ii) determining the compliance of Buyer's use of the Products with applicable laws, regulations, codes and standards. Buyer retains and accepts full responsibility for all warranty and other claims relating to, or arising from, Buyer's Products which include or incorporate Products or components manufactured or supplied by Seller. Buyer is solely responsible for any and all representations and warranties regarding the Products made or authorized by Buyer. Buyer will indemnify Seller and hold Seller harmless from any liability, claims, loss, cost or expenses (including reasonable attorneys' fees) attributable to Buyer's products or representations or warranties concerning same.

(g) This manual may contain reference to, or information about, Elo products (equipment or programs), that are not now available. Such references or information must not be construed to mean that Elo intends to provide such products, programming, or services.

FCC Notice

This device complies with Part 15 of the FCC Rules. Operation is subject to the following two conditions: (1) This device may not cause harmful interference, and (2) this device must accept any interference received, including interference that may cause undesired operation.

UL Notice

Elo PC-Bus controllers are for use only with IBM or compatible UL Listed personal computers that have installation instructions detailing user installation of card cage accessories.

Table of Contents

| | | | |
|--|----------|---|-----------|
| Limited Warranty | v | Chapter 4 | |
| List of Figures | xi | Component Installation | 19 |
| Chapter 1 | | Safety Information | 20 |
| Introduction | 1 | Work Area | 20 |
| Introducing Touchscreens | 1 | Protective Clothing | 20 |
| Driver Software | 2 | Getting Started | 21 |
| Shipping Damage | 2 | Bezel Design | 22 |
| Care and Cleaning | 2 | Testing Components | 22 |
| | | Installation Steps | 23 |
| | | Suggested Tools | 23 |
| Chapter 2 | | Disassembling the Display | 24 |
| About AccuTouch Touchscreens | 5 | Removing the Back Case | 24 |
| Introduction | 5 | Discharging the CRT | 25 |
| The AccuTouch Touchscreen | 6 | Removing the Electronics Chassis | 26 |
| The AccuTouch Controllers | 8 | Removing the CRT | 27 |
| Driver Software | 8 | Installing the Touchscreen | 28 |
| | | Spacing the CRT from the Bezel | 32 |
| Chapter 3 | | Transient Protection | 34 |
| Touchmonitor Installation | 9 | Controller Interface Options | 35 |
| Touchmonitor Benefits | 9 | Internal Controllers | 36 |
| Touchmonitor Configurations | 10 | 2210 Serial Controller and 3000U USB | |
| Touchmonitor Connections | 10 | Controller | 36 |
| Connecting the Power and Video | 10 | Installing the 2210 Serial Controller | 37 |
| Touchmonitor with Internal Serial Controller | 11 | Installing the 3000U USB Controller | 39 |
| Contents | 11 | External Controllers | 41 |
| Installation | 11 | Installing the 2210MX Serial Controller | 41 |
| Touchmonitor with Internal USB Controller | 12 | Installing the 2201 PC-Bus Controller | 42 |
| Contents | 12 | Routing the Touchscreen Cables | 44 |
| Installation | 12 | Reassembling the Monitor | 45 |
| 2210MX External Serial Controller | 13 | Sealing the Monitor | 46 |
| Contents | 13 | Flat Panel Display Integration | 47 |
| Installation | 13 | Where to Go from Here | 47 |
| Configure the Controller | 13 | | |
| Connect the Controller | 13 | Appendix A | |
| PC-Bus Controller | 15 | Troubleshooting Guide | 49 |
| Contents | 15 | The Troubleshooting Process | 49 |
| Installation | 15 | Display Problems | 50 |
| Configure the Controller | 15 | Software Troubleshooting | 50 |
| Install the Controller in Your PC and Connect | | Video Alignment Problems | 51 |
| the Touchmonitor | 15 | Hardware Troubleshooting | 51 |
| Touchscreen Application Tips | 16 | Touchscreen Diagnosis | 53 |
| Where to Go from Here | 18 | Touchscreen Simulation | 55 |
| | | Serial Controller | 57 |
| | | Using the COMDUMP Utility | 57 |
| | | E271-2210 Controller Protocol | 58 |

| | |
|--|----|
| E281A-4002 Controller Protocol | 58 |
| E271-140 Controller Protocol | 58 |
| E261-280 Controller Protocol | 58 |
| Using the TOUCHES Utility | 59 |
| RS-232 Connections | 59 |
| Power Supply | 61 |
| Bus Controller | 62 |
| Using the BUSSTAT Utility | 62 |
| Touchscreen Cables | 63 |
| P/N 454173-000 Cable | 63 |
| Transient Protection Components | 64 |
| Diagnostic LEDs | 64 |
| 2210 Serial Controller | 64 |
| 3000U USB Controller | 65 |
| 2201 PC-Bus Controller | 65 |
| Diagnostic Codes | 66 |
| DB9 and DB25 Connector Pin Positions | 67 |

Appendix B
Controller Configuration **69**

| | |
|----------------------------------|----|
| General Information | 69 |
| Jumper Settings | 70 |
| 2210 Serial Controller | 71 |
| Jumper Settings | 72 |
| 2210 Emulation Modes | 73 |
| 3000U USB Controller | 73 |
| 2201PC-Bus Controller | 73 |
| Jumper Settings | 74 |
| 2201Emulation Modes | 75 |

Appendix C
Specifications **77**

Appendix D
Elo Part Numbers **81**

Glossary **85**

Index **91**



List of Figures



| | |
|--|----|
| AccuTouch Touchscreen | 6 |
| USB Controller Installation | 12 |
| External Serial Controller Installation | 14 |
| PC-Bus Controller Installation | 16 |
| Typical AccuTouch Touchscreen Installation (for use with external controller) | 21 |
| Bezel design | 22 |
| Rear View of an AccuTouch Touchscreen with Mounting Materials | 30 |
| Side View of an AccuTouch Touchscreen Installation | 35 |
| Touchscreen Cabling System for Internal Serial Controller | 36 |
| AccuTouch Touchscreen Simulation Circuits | 56 |
| Tabletop Controller Power Supply Cable Connector | 61 |
| Transient Protection Circuit | 64 |
| DB9 and DB25 Connector Pin Positions | 67 |
| SmartSet Controller Jumper Settings | 70 |
| E271-2210 Serial Controller | 71 |
| E271-2201 PC-Bus Controller | 73 |

INTRODUCTION

Introducing Touchscreens

Touchscreens are the ultimate operator/machine interface. In a touchscreen system, you touch what you see. The computer responds. The human action and the computer's reaction is simple, direct, and natural. Using touchscreens, workers can control complicated processes. People who have never used a computer before can interact easily with a touchscreen-based system. Touchscreens bring the power of the computer within reach—in airports, factories, shopping malls, schools, and hospitals.

Applications for touchscreens include:

- Public Information Systems
- Multimedia
- Retail and Point-of-Sale
- Process Control
- Instrumentation
- Gaming
- Ticket and Lottery
- Simulation and Training
- Education

The AccuTouch[®] Model:SCN-AT (E274) touchscreen product line is based on patented resistive technology. The AccuTouch touchscreen has gained a worldwide reputation for fast, responsive accuracy and reliability. It has an unmatched combination of performance, size, and environmental adaptability.

Because of its many unique features, the AccuTouch touchscreen is ideally suited for retail and restaurant point-of-sale, medical, instrumentation, and process control applications. In fact, the AccuTouch touchscreen is used in more applications than any other touchscreen.

Driver Software

Elo driver software provides a consistent software interface among all Elo touchscreens and controllers.

The driver software scales the absolute coordinates received from the touchscreen controller into *translated* screen coordinates, using the calibration points obtained with the video alignment program included with the driver software. The driver also performs other operations as directed by the application.

Elo provides driver programs for the DOS, Windows 3.1, Windows CE, Windows 95/98, Windows NT, Windows 2000, OS/2, and Macintosh operating systems. Additional drivers are also available. Additional operating systems are supported through outside sources. Refer to the Elo web site, www.elotouch.com, for details.

If you cannot use an available driver, Elo can supply all the touchscreen related information you will need to write your own driver for any type of system, including UNIX workstations, real-time systems, and embedded systems. For the 2500S controller, the *SmartSet™ Touchscreen Controller Family Technical Reference Manual* which is available on the Elo web site, provide information on this process. Machine-independent source code is included on a companion disk and web site, www.elotouch.com.

Shipping Damage

If you notice damage to the shipping carton, or concealed damage, be sure to save all packing materials for later inspection by the carrier, who is responsible for any shipping damage.

If failure occurs during the warranty period, see the *Limited Warranty* section at the beginning of this manual for instructions.

Care and Cleaning

Handle the touchscreen with reasonable care when not integrated into a monitor. Do not pull or stress the cables.

Clean the touchscreen with Isopropyl 99% and lint free wipes. Always dampen the wipes and then clean the touchscreen.

For operating and storage specifications, refer to Appendix C.

ABOUT ACCU TOUCH TOUCHSCREENS

Introduction

The Elo AccuTouch touchscreen system consists of a touchscreen and an electronic touchscreen controller. The AccuTouch touchscreen is based on patented resistive technology. The touchscreen may be a flat, spherical, or cylindrical and is installed over the face of the display. Since its shape matches that of the display face, an AccuTouch touchscreen has excellent clarity and minimal parallax.

AccuTouch features include:

- Proven resistive technology.
- High accuracy and fast response.
- Hard-coated surface for scratch protection.
- Clear finish for maximum image clarity, or antiglare finish for reflection control.
- Pressure-activated by a finger, fingernail, gloved hand, or any stylus.
- Large selection of standard sizes for spherical, and flat displays.
- Custom sizes for OEM quantities.
- Easily sealed to enclosure for harsh environment protection.
- Operates even when wet.

The AccuTouch Touchscreen

The AccuTouch resistive touchscreen consists of a glass panel molded to the precise shape of a display's face. A scratch-resistant, hard-coated plastic cover sheet is suspended over the surface of the glass by less than one-thousandth of an inch with tiny separator dots. The cover sheet may be clear for best image clarity or have an antiglare finish. For optimum optical performance, the touchscreen may be optically bonded to the cathode ray tube (CRT) face. See figure 2-1 for details on the construction of an AccuTouch touchscreen.

The glass is coated with a transparent uniform resistive coating, and the cover sheet has a conductive coating. With a light touch on the cover sheet, the conductive inner surface of the plastic makes contact with the resistive coating on the glass. There is an electrical drive connection to each of the four corners of the resistive coating, and a pickup connection to the coating on the cover sheet. When the proper DC voltages are applied to the drive connections, the voltage at the pickup connection is proportional to the position of the touch.

Refer to the Elo web site, www.elotouch.com, for more information on how the AccuTouch resistive touchscreen operates.

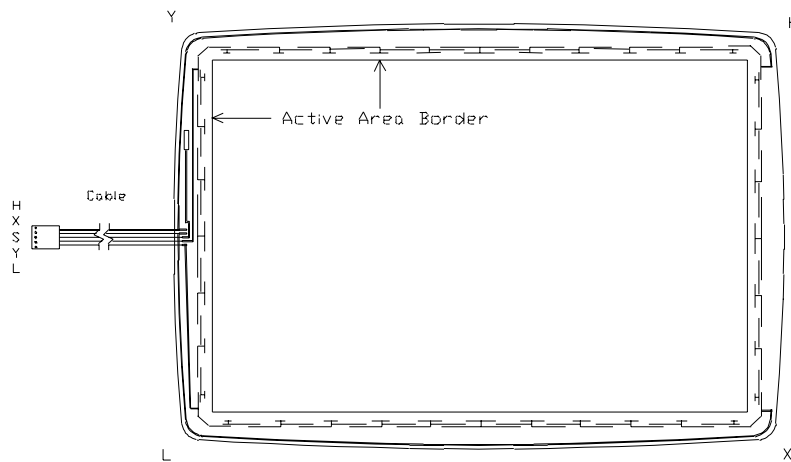

Figure 2.1 AccuTouch Touchscreen

The logical sequence of operation of an AccuTouch controller, used in combination with the AccuTouch touchscreen, is as follows:

- 1** When the controller is waiting for a touch, the resistive layer of the touchscreen (the coating on the glass) is biased at +5 Vdc through all four drive lines, and the cover sheet is grounded through high resistance. When the touchscreen is not being touched, the voltage on the cover sheet remains at zero. The voltage level of the cover sheet is continuously converted by the analog to digital converter (ADC) and monitored by the microprocessor on the controller. When the touchscreen is touched, the microprocessor detects the rise in the voltage of the cover sheet and begins coordinate conversion.
- 2** The microprocessor places the X drive voltage on the touchscreen by applying +5 Vdc to Pins H and X and grounding Pins Y and L.
- 3** An analog voltage proportional to the X (horizontal) position of the touch appears on the cover sheet at Pin S of the touchscreen connector. This voltage is then digitized by the ADC and subjected to an averaging algorithm, then stored for transmission to the host.

The averaging algorithm reduces noise resulting from contact bounce during the making and breaking of contact with the touchscreen. Successive X coordinates are tested to determine that their values differ by no more than a certain range. If one or more samples fall outside this range, the coordinates are discarded and the process is restarted. This is continued until several successive X coordinates fall within the range. The average of these values is used as the X coordinate.

- 4** Next, the microprocessor places the Y drive voltage on the touchscreen by applying +5 Vdc to Pins H and Y and grounding Pins X and L.
- 5** An analog voltage proportional to the Y (vertical) position of the touch now appears on the cover sheet at Pin S of the touchscreen connector. This signal is converted and processed as described above for the X position.
- 6** Successive coordinate pairs are sampled to eliminate the effects of noise. If a sample does not fall within an internal range, all X and Y coordinates are discarded and the X sequence is restarted at step 2.
- 7** Once acceptable coordinates have been obtained, an average coordinate is determined and communicated to the host processor.

The X and Y values are similar to Cartesian coordinates, with X increasing from left to right and Y increasing from bottom to top. Z increases with touch pressure. These *absolute* coordinates are arbitrary and unscaled, and will vary slightly from unit to unit. Any coordinate normalization or scaling must be done at the driver level, and calibration to the display image must be performed for each unit. Because of the stability of the AccuTouch system, recalibration is not necessary unless the position of the image changes.

The AccuTouch Controllers

The AccuTouch controllers provide the drive signals for the touchscreen, convert the received analog signals into digital touch coordinates, and send these coordinates to the computer.

Controllers are available for the AccuTouch touchscreen with serial RS-232 or PC-Bus (ISA or EISA compatible). Controller options are detailed in Chapter 3. For large-volume users, it may be cost-effective to integrate the Elo COACH™ and COACH IIs (Controller On A CHip) directly into your board-level design. Contact Elo for details.

Resolution and performance of the AccuTouch system are defined by the controller. Unscaled coordinate ranges are about 400-3800 for X and 600-3500 for Y, with over 200 coordinates per second possible. See the *SmartSet™ Touchscreen Controller Family Technical Reference Manual* available at www.elotouch.com/support/dwnldmnl.asp and www.elotouch.com/products/accutec/c3000u.asp.

Driver Software

Elo driver software provides a consistent software interface among all Elo touchscreens and controllers.

The driver software scales the absolute coordinates received from the touchscreen controller into *translated* screen coordinates, using the calibration points obtained with the calibration program included with the driver software. The driver also performs other operations as directed by the application.

Elo provides driver programs for a variety of operating systems. Go to www.elotouch.com/Support/dnld.asp for a complete list of available drivers.

If you cannot use an available driver, Elo can supply all the touchscreen related information you will need to write your own driver for any type of system, including UNIX workstations, real-time systems, and embedded systems. The *SmartSet Touchscreen Controller Family Technical Reference Manual* available at www.elotouch.com/support/dwnldmnl.asp, gives step-by-step instructions on this process. Machine-independent source code is included on a companion disk along with a setup utility.

TOUCHMONITOR INSTALLATION

Elo purchases and resells a variety of monitors, called Touchmonitors, both CRT and LCD, with touchscreens and all related components fully installed. If you are installing components rather than a touchmonitor, proceed to Chapter 4, install your touchscreen components, then return to this chapter.

Touchmonitor Benefits

Touchmonitor benefits include:

- Single source for touchscreen and display.
- Professionally engineered touchscreen installation.
- UL,cUL, FCC, TÜV, CE, and other agency approvals.
- Elo warranty.
- Plug-and-play convenience.

Controller boards, cables, and power supplies may also be ordered separately.

Touchmonitor Configurations

This chapter assumes you have one of the following:

- A touchmonitor with an internal 2210 serial controller.
- A touchmonitor with an internal 3000U USB controller.
- A touchmonitor with one of the following external controllers:
 - 2210MX serial controller.
 - 2201 PC-Bus controller.

Touchmonitors with an internal serial controller typically have a DB9 *female* RS-232 connector on the back of the touchmonitor. A serial cable connects directly from the back of the touchmonitor to the serial port on the computer.

Touchmonitors with an internal USB controller will have a USB cable exiting the back of the touchmonitor. The USB cable connects directly to a USB port on the computer.

The 2210MX serial controller is typically mounted on the back of the display and uses either a keyboard power tap or external power supply. The serial cable attached to the controller enclosure connects to the serial port on your computer.

PC-Bus controllers plug directly into a slot in your computer and do not require a special enclosure or power supply. A cable connects directly from the back of the touchmonitor to the PC-Bus controller.

Controller boards, cables, and power supplies may also be ordered separately.

Touchmonitor Connections

Connecting the Power and Video

If you do not have a touchscreen installed in your display, skip to Chapter 4, which details the installation of touchscreen and controller components.

The video display function of the touchmonitor and the touchscreen installed on the monitor are entirely separate systems. You should first connect and test your touchmonitor as a video display only. Follow the instructions provided by the monitor manufacturer.

Next, refer to the appropriate page to continue your installation:

| Controller | Configuration | Page |
|-------------------|--|-------------|
| 2210 | Touchmonitor with Internal Serial Controller | 11 |
| 3000U | Touchmonitor with Internal USB Controller | 12 |
| 2210 | 2210MX External Serial Controller | 13 |
| 2201 | PC-Bus Controller | 15 |

Touchmonitor with Internal Serial Controller

Contents

This configuration includes a touchmonitor with an internal 2210 serial controller and a serial cable. Actual configuration may vary due to third-party integrations.

Installation

The 2210 controller is internal to the monitor and is shipped preconfigured for use with Elo software.

Complete these steps:

- 1** Plug the DB9 male end of the supplied serial cable into the DB9 female connector typically labeled "Touch Interface" on the back of the touchmonitor case.
- 2** Plug the DB9 female end of this cable into the computer's DB9 serial port. If you have a 25-pin serial port, use a DB9 male to DB25 female adapter.

Proceed to "Where to Go from Here" on page 3-18.

Touchmonitor with Internal USB Controller

Contents

This configuration includes a touchmonitor with an internal 3000U USB controller.

Installation

Note: You can leave your computer on when you connect to a USB port.

The 3000U USB controller is internal to the monitor and is shipped preconfigured for use with Elo software.

Complete this step:

- 1 Plug the USB cable exiting the touchmonitor into a USB port on the computer.

Proceed to “Where to Go from Here” on page 3-18.

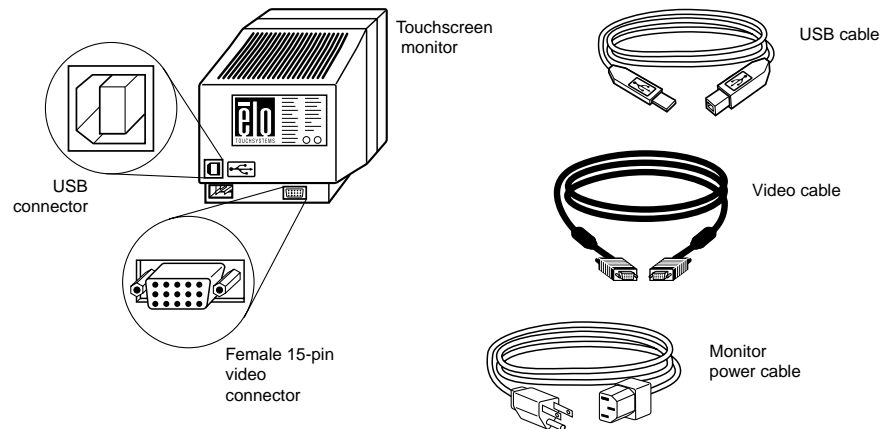

Figure 3.1 USB Controller Installation

2210MX External Serial Controller

Contents

This configuration includes a 2210 serial controller in a small enclosure with a keyboard power tap or external power supply and connecting cables.

Installation

Complete these steps:

- 1 Configure the controller
- 2 Connect the touchscreen controller and the supplied cables.

Configure the Controller

The controller is shipped preconfigured for use with Elo software. No changes are necessary for most users. Specific settings and options available for your controller are listed in Appendix B.

The 2210MX External Serial Controller is typically shipped configured at 9600 baud. If your software does not support the 2210 directly, you may operate the 2210 in E271-140, E261-280, or E281A-4002 emulation modes. See B for jumper settings.

Additional technical information about the 2210 controller can be found in the *SmartSet Touchscreen Controller Family Technical Reference Manual*, available at www.elotouch.com/support/dwnldmnl.asp.

Connect the Controller

CAUTION Before using a keyboard power tap, be sure sufficient power is available for the touchscreen controller or damage may occur to the computer.

Before connecting a keyboard power tap to the controller, be sure that power to the computer is OFF. Connecting a keyboard power tap to a powered computer may seriously damage the computer or the controller.

Complete the following steps if you are using a **keyboard power tap**:

- 1 Two different keyboard power taps are available. Use Elo P/N 980773-000 if you have a standard keyboard connector and Elo P/N 388923-000 if you have a PS/2 keyboard connector.
- 2 Unplug the keyboard from the computer.
- 3 Plug the male connector on the **Y** end of the adapter cable into the keyboard connector on the back of the computer.

- 4 Plug the keyboard cable into the female connector on the **Y** end of the adapter cable.
- 5 Plug the other end of the adapter cable into the connector on the serial cable.
- 6 Plug the DB9F end of the attached serial cable into a serial port.
- 7 Proceed to “Where to Go from Here” on page 3-18.

Complete the following steps if you are using a **wall mount power supply**:

- 1 Two different wall mount power supplies are available. Use Elo P/N 580979-000 if you are using this inside the United States and Elo P/N 319865-000 if you are using this outside of the United States.
- 2 Plug the single male connector on one end of the power supply into the connector on the serial cable.
- 3 Plug the other end of the power supply into a proper receptacle.
- 4 Plug the DB9F end of the attached serial cable into a serial port.

Proceed to “Where to Go from Here” on page 3-18.

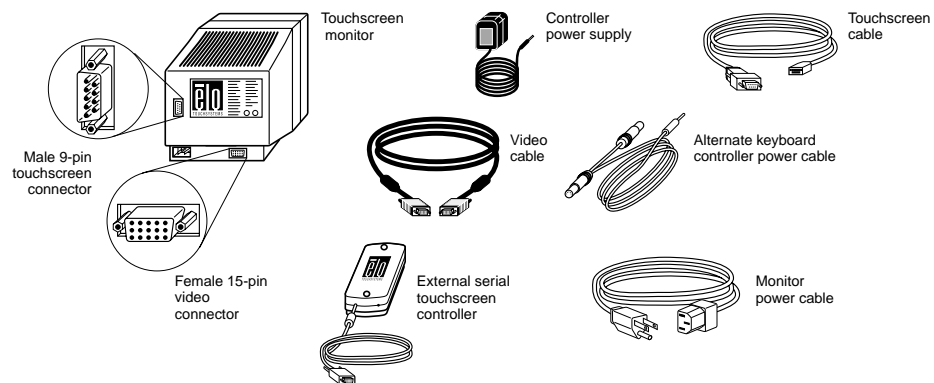

Figure 3.2 External Serial Controller Installation

PC-Bus Controller

Contents

This configuration includes the 2201 PC-Bus controller and a touchscreen cable.

Installation

Complete these steps:

- 1 Configure the controller.
- 2 Install the controller in your PC and connect the touchmonitor.

Configure the Controller

The controller is shipped preconfigured for use with Elo software. Except for the Base I/O Port and Interrupt (IRQ) settings, no changes are necessary for most users. Specific jumper settings and options available for your controller are listed in Appendix B.

If your software does not support the 2201 directly, you may operate the controller in E271-141 emulation mode. See B for jumper settings.

Additional technical information about the 2201 controller can be found in the *SmartSet Touchscreen Controller Family Technical Reference Manual*, available at www.elotouch.com/support/dwnldmnl.asp.

Install the Controller in Your PC and Connect the Touchmonitor

Complete these steps:

- 1 Discharge any static charge on your body by touching the back of the computer cabinet.
- 2 Note the Base I/O Port for use with the driver software. Factory default settings are 280 (hexadecimal) and no interrupt. (The driver software selects the interrupt.)
- 3 Turn the computer off and unplug the AC power cord from the outlet.
- 4 Remove the computer's cover. Refer to the computer user's manual for instructions.
- 5 Choose an available expansion slot.
- 6 Remove the screw holding the expansion slot's access bracket, then remove the bracket.

- 7 Insert the touchscreen controller into the expansion slot. The controller should seat fully into the slot and the access bracket should mate with the frame of the computer.
- 8 Replace the access bracket retaining screw, insuring that the controller remains seated in the socket.
- 9 Replace the computer's cover.
- 10 Plug the DB9 female end of the supplied touchscreen cable into the DB9 male connector labeled "Touchscreen Interface" on the back of the touchmonitor case. Plug the DB9 male end of the touchscreen cable to the DB9 female connector on the controller.
- 11 Plug the AC power cord back into the outlet and reboot the computer.
- 12 Proceed to "Where to Go from Here" on page 3-18.

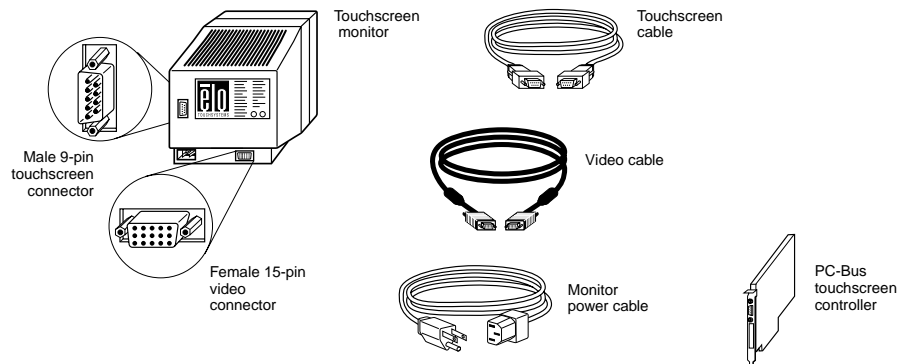

Figure 3.3 PC-Bus Controller Installation

Touchscreen Application Tips

Sometimes a simple change to your application may mean the difference between success and failure.

- 1 Windows applications should be run full screen-don't display a title bar or menu bar in kiosk applications.
- 2 Bright background colors (no black!) in your application will hide fingerprints and reduce glare. Dithering or other patterned backgrounds, such as a crumpled paper look, will help the eye focus on the screen image instead of reflections, even in areas with no icons or menu choices.
- 3 Use a simple point-and-click interface with large buttons. Do not use dragging, double-clicks, scroll bars, drop-down menus, multiple windows, or

other elements that can confuse the user and interfere with usability and efficiency.

- 4** Turn the cursor off—your user will focus on the entire screen instead of the arrow. A cursor on the screen makes the user subconsciously think, “How do I get the arrow to do what I want?” Remove the cursor, and the user’s thinking and action will be direct instead of indirect, unlocking the true power of touchscreens.
- 5** Always give your users feedback as soon as they touch the screen. A 3-D button effect (similar to a Windows standard button) works well. Output a “click” or other sound whenever they touch the screen. Also, be sure that the display clears immediately and displays an hourglass while loading the next screen. Immediate feedback is critical to reassure users that their touch is registered.
- 6** Make your application run fast. Users will walk away from a sluggish system, but you can keep their attention with a quick response to touches. Speedy systems also reduce vandalism. (Graphics modes with excessive colors or resolution only slow down your system, Using 256 colors is typically more important than resolution above 640 x 480.)
- 7** Try to make the application intuitive; limit choices; and guide the user as much as possible. Testing your application on focus groups will disclose the areas that need improvement. If anyone pauses in confusion for even a moment, think how to improve the application.
- 8** Digitized speech via a sound card can walk users through your application. For example, “Touch the first letter of the company you are looking for.” Click. “Now touch OK.” There is something almost magical about a user interface with voice prompting and touch response. Your brain can simultaneously process voice while absorbing image.
- 9** Animation and large fonts help attract users to kiosk applications. The kiosk design (cabinet) should also be attractive.
- 10** When designing a kiosk cabinet, consider the following. If using forced air ventilation, put your fan at the top, near the monitor’s vents. Keep the intake away from the floor and airborne dust from footsteps. Keep air from entering around the CRT face, too. The kiosk design should accommodate variation in monitor dimensions and bezels, as monitor models may come and go every few months. Remember to point your speakers in the direction of the user’s ears. Finally, choose a finish that does not show fingerprints—avoid polished stainless steel, chrome, or glossy black paint.

Where to Go from Here

The hardware installation is now complete.

Load the Elo driver specific to your operating system

If you will be writing your own driver program, see the *SmartSet Touchscreen Controller Family Technical Reference Manual* available at www.elotouch.com/support/dwnldmnl.asp for step-by-step instructions on this process. Machine-independent source code is included on a companion disk along with a setup utility.

COMPONENT INSTALLATION

Elo purchases and resells a variety of monitors, called touchmonitors, with touchscreens and all related components fully installed. If you already have a touchmonitor, follow the installation instructions in Chapter 3.

If you do not have a touchmonitor, read this chapter for details on installing touchscreen components that will convert your monitor into a touchmonitor. Details are given on mounting the touchscreen, controller, and connecting cables. While this chapter refers primarily to CRT-based monitor technologies, much of this information can be applied to other monitor technologies. See “Flat Panel Display Integration” on page 4-47.

These instructions assume you have purchased an Elo touchscreen installation kit (P/N 458095-000), and a transient protection cable (PN 899389-000). Only a minimum of equipment and materials is required beyond what is provided in the kits.

In brief, adhesive materials are used to fasten the touchscreen to the CRT and then the assembly is reinstalled in the original enclosure with minor modifications. If this procedure is not suitable for mechanical, electrical, or optical reasons, there are other techniques for touchscreen installation that may achieve the desired results. These techniques often require specialized equipment or materials, and a complete discussion is beyond the scope of this manual. See “Installing the Touchscreen” on page 4-28.

Safety Information

WARNING:  The touchscreen installation procedure outlined in this chapter may require exposure to high-voltage components and handling of the CRT. This procedure can be dangerous and an accident is potentially lethal. Therefore, the procedure should only be performed by a qualified person. Read this entire chapter before attempting a touchscreen installation. Follow the procedure carefully, work with the power off and the unit unplugged, observe all warnings, and wear protective clothing. Elo is not liable for damage or injury that could result from your actions.

Consider purchasing a touchmonitor from Elo if you do not have previous experience working with touchscreens and disassembling monitors. Elo also offers touchscreen installation services for customers specified monitor.

Work Area

Before proceeding with the installation, prepare a padded work surface. A plastic waste basket is recommended for supporting the CRT during part of the installation.

Protective Clothing

Wear safety glasses, gloves, a rubber apron, and heavy protective clothing for any portion of this procedure that involves handling or working near the CRT.

Getting Started

AccuTouch touchscreens can be installed on most types of monitors. Figure 4-1 shows a typical installation.

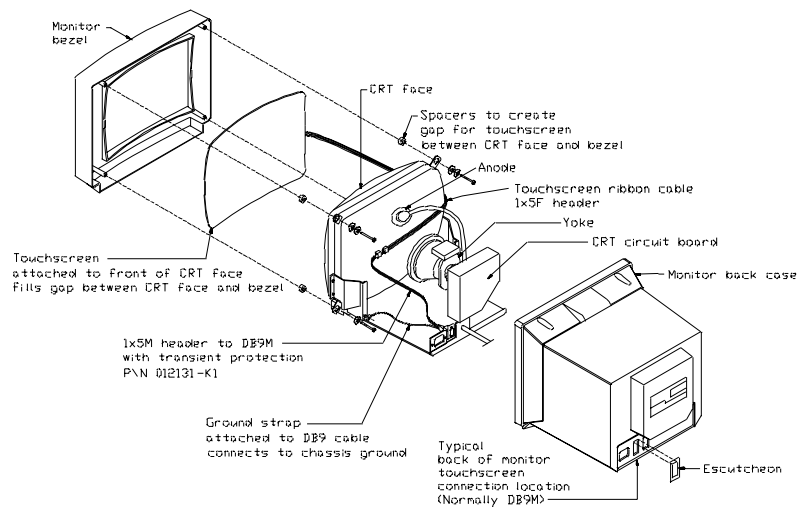

Figure 4.1 Typical AccuTouch Touchscreen Installation (for use with external controller)

AccuTouch touchscreens are available for most monitors. Each monitor may pose unique installation issues. Although your monitor may not be a standard touchmonitor product from Elo, we may have had some experience with it. Contact Elo Technical Support for more information.

This section assumes you have already determined compatibility between the touchscreen and the monitor. A touchscreen installation kit is available from Elo (P/N 458095-000), which includes the commonly used materials needed for installation.

Most monitors require complete disassembly, including removal of the CRT, to install a touchscreen. Disassembling the monitor can be a dangerous procedure if done improperly. Before proceeding, review the rest of this chapter. Basic assembly skills are required. Seek qualified help if you have any doubts about your ability to complete the installation.

Any damage to the monitor or the touchscreen as a result of improper installation is the installer's responsibility.

Without prior approval of the monitor manufacturer, you will probably void the monitor's warranty by disassembling it. Also, it will be necessary to recertify the monitor and touchscreen system for regulatory agencies (such as FCC, UL/CSA, TÜV, CE, etc.) if those certifications were originally present and need to be maintained for your intended application. (Elo offers touchmonitors with full agency approvals.)

Handle the touchscreen with care. Avoid excessive handling and stress on the touchscreen cable.

Bezel Design

The following graphic displays some bezel ideas in order to help you mount the bezel to the touchscreen.

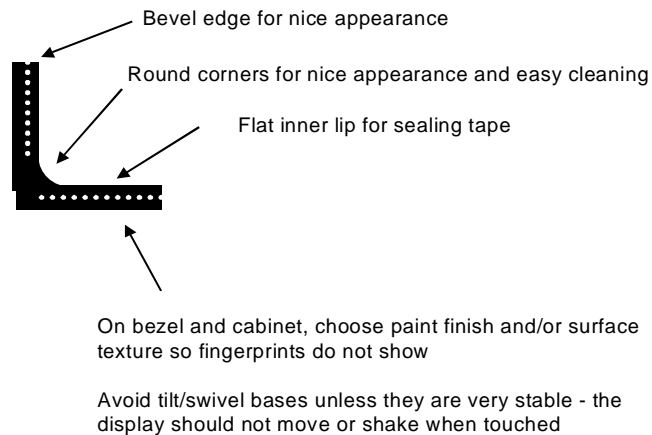

Figure 4.2 Bezel design

Testing Components

The display must be in good working order before beginning the installation of the touchscreen. With a new display, it is suggested that you test the display by running it overnight. Do not leave a constant image at normal brightness on the screen during this test, as it may burn an image into the screen.

Familiarize yourself with the operation of the touchscreen and controller before you proceed with the installation. Use the COMDUMP, BUSSTAT, or TOUCHES programs as described in Appendix A to test serial and PC-Bus controllers while the touchscreen components are arranged on the work surface.

Currently, there is no separate diagnostic test for USB controllers.

Installation Steps

The installation process consists of the following steps:

- Disassembling the monitor.
- Attaching the touchscreen to the CRT.
- Installing transient protection.
- Optionally installing an internal serial controller.
- Interfacing the touchscreen or serial data cables to the exterior of the monitor.
- Reassembling the monitor.
- Optionally sealing the monitor.

Specific compatibility may not be confirmed until well into the installation.

Suggested Tools

The following is a list of tools that may be needed to install the touchscreen. Some of the tools are optional, but will be useful if needed.

- Long (at least 9 inches, 200 mm) flat blade screwdriver with insulated handle.
- Clip lead or heavy-gauge wire.
- #2 Phillips screwdriver.
- Scissors.
- X-Acto knife (No. 11 blade) or hand milling tool.
- DB9 hole punch.
- Cable ties.
- Household glass cleaner.
- Paper towels.
- Small containers or plastic bags to hold loose parts.

The Elo Touchscreen Installation Kit (P/N 458095-000) is also recommended, and includes commonly used materials needed for touchscreen installation. This kit is useful for identifying preferred materials for your own procurement and may also be cost-effective and convenient when purchased for a limited number of installations. A copy of the monitor manufacturer's service manual is also useful, if available.

Disassembling the Display

Disassemble the monitor on a large, well-lit work surface. Leave space to set aside major monitor components. Group screws and other hardware in small containers or in specific areas on the work surface as you remove them, in relation to the part of the monitor where you are working. If you complete the installation process in one session (which may require several hours for your first efforts), it is unlikely that you will have trouble reassembling the monitor.

Most monitor manufacturers connect the major components with detachable cables that have labeled and keyed connectors; these cables are of lengths that will usually connect to only one place. Also, screws are identifiable by type and size, and usually will not fit in the wrong place. The most difficult problem with missing or wrong hardware or connections will be with single ground cables that attach to obscure ground points on the metal chassis. When in doubt, make notes of the connection points.

Removing the Back Case

Figure 4.1 on page 4-21, shows the typical construction of a 14-inch monitor. Disassembly usually starts with removal of the back case. For assistance with disassembly, consult your particular manufacturer's service manual. Carefully lay the monitor on its face on the padded work surface and remove the screws that attach the back case to the bezel or frame.

While removing the back case, note the clearance between the inside rear surface of the case and a small circuit board plugged into a socket on the end of the CRT. If there is not enough clearance to move the CRT and this circuit board about 3/8-inch (9 mm) toward the rear of the case, you may be unable to successfully install a touchscreen on the monitor and completely reinstall the back case. Contact Elo Technical Support for possible alternatives.

After the back case is removed, the CRT is substantially exposed. Use extreme care when working around the CRT.

WARNING:



Impact or force against the neck of the CRT, or the pins at the end where the small circuit board is attached, could crack the tube, resulting in loss of vacuum or implosion of the tube. Either result destroys the CRT. Implosion (collapse of the glass inward, caused by the high vacuum inside the tube), followed by the rebound of many glass pieces outward, is potentially lethal to anyone in the immediate area. Handle the CRT carefully, keep tools away from the CRT, and wear protective clothing including eye protection. See Safety Information, page 20.

Discharging the CRT

WARNING: Dangerous voltages may be present on the CRT anode. The anode may retain a very dangerous voltage even after the monitor has been off for days. Accidental contact with the anode lead or anode button (the small hole in the CRT glass where the anode lead is attached) prior to discharge may result in a potentially lethal shock. Follow the procedure below carefully to avoid injury.



The anode lead of the monitor feeds high voltage from the flyback transformer to the anode button on the CRT. The anode lead is usually red in color, and the actual connection to the anode button is usually covered by a large rubber suction cup-like boot. In most monitors, the button is located on the tapered face, or bell, of the CRT glass near the top of the monitor. See Figure 4.1 on page 4-21.

It may be necessary to remove some sheet metal to gain access to the anode lead—be very careful to do this without making contact to the anode lead itself.

Carefully discharge the CRT using the following procedure:

- Connect a clip lead or a heavy-gauge wire to chassis ground of the monitor (or if the CRT is free-standing, the mounting ears or the spring-tensioned ground strap).
- Connect the other end of the clip lead or wire to the stem of a flat blade screwdriver that has an insulated handle.
- Hold the screwdriver by the insulated handle only. Insert the blade of the screwdriver under the rubber boot and make contact with the anode lead at the button. A distinct “snap” may or may not be heard as it discharges, depending on the amount of charge present on the anode.
- Disconnect the anode lead from the button by unhooking the spring wire clips. Note the location of the anode for proper CRT orientation during reassembly.

WARNING: The CRT will regain a charge over time, even after it has been discharged. To avoid a dangerous electric shock, always discharge the CRT just before handling it, and treat it with respect thereafter.



Removing the Electronics Chassis

Continue disassembling the monitor until the face of the CRT is completely exposed. The degree of disassembly required will vary from monitor to monitor.

Normally the next step will be to remove the electronics chassis from the monitor. This requires removal of a small circuit board that is usually plugged into the socket on the end of the CRT. The circuit board is often glued to the CRT socket with a soft adhesive which must be cut away to remove the board. Several cables must also be unplugged from the electronics. Typically these cables are:

- Four wires from the yoke of the CRT, typically in a single four-pin connector. The yoke is the copper wire and magnet assembly at the base of the neck of the CRT. MPR II-compliant monitors may have additional cables and connectors on the yoke.
- A two-wire cable from the degaussing coil. This coil may be attached to the CRT, or be laying out of sight between the CRT and the bezel. Some monitors may have two separate coils.
- A one- or two-wire ground cable connected between the CRT circuit board and a ground strap. This strap is a long, annulated, braided wire which is spring tensioned to maintain contact with the bell of the CRT.
- Various cables connected to the power switch, pilot light, front panel controls, etc.

Other cables may have to be unplugged from the electronics chassis. The need for this may not be apparent until the chassis is removed, as instructed below.

Another preliminary step in determining touchscreen-monitor compatibility should be performed at this point. Before removing the electronics chassis, note the clearance between the chassis components and the bell of the CRT. Since the standard technique for mounting the touchscreen involves moving the CRT back in the monitor chassis, there must be enough clearance between components on the chassis and the CRT *after* allowing for about 1/4-inch (6 mm) movement of the CRT towards the rear of the chassis. Failure to allow for this clearance requirement may result in mechanical damage later (especially in shipping). It may also cause electrical damage from shorts between "live" components on the chassis, such as heat sinks or uninsulated component leads, and the bell of the CRT which is usually painted with a conductive coating that is grounded to the chassis through the braided wire ground strap. Repositioning or substituting low profile components may be an option. Contact Elo Technical Support for assistance (1-800-557-1458 x6).

After disconnecting any necessary cables, remove the screws that attach the electronics chassis to the bezel. Note the bezel is essentially where all parts of the mechanical assembly are attached, unless you have a rare unit that has an internal frame. As you pull the chassis away from the bezel, make sure that cables and circuit boards do not hit the neck of the CRT and that nothing becomes caught on the adjustment rings or other components on the neck of the CRT. Also watch for other cables that need to be disconnected. After removal, set the electronics chassis aside.

Removing the CRT

Removal of the CRT is next. Prepare a soft surface to set the CRT on. Remove the screws attaching the CRT to the bezel, and then remove the CRT. Do not lift or carry the CRT by the neck or yoke assembly. Avoid contact with the anode button, which may still have some residual charge on it, (you may wish to discharge it again at this point). Set the CRT on the prepared surface.

Several other preliminary compatibility requirements should now be assessed:

- Position the CRT so the face is accessible, providing a soft cushion for the neck and the yoke if they must rest on the work surface. Alternatively, set the CRT face-up in an office-type plastic waste basket, *making sure that the tube is not resting on the neck (The small part of the CRT is the neck)*. Place the touchscreen on the face of the tube, and check to see that the face of the CRT and touchscreen are about the same size, and that the radius of curvature (ROC) of each surface matches well. If both of these conditions are not met, you may not have the proper touchscreen for the monitor. Most color monitors have standard size CRT's with standard ROC's, and Elo has touchscreens for most of them.
- Next, determine if the touchscreen will fit in the bezel without modifications to the bezel. Modifications, if necessary, should be done without compromising the mechanical integrity of the monitor.
 - Lay the touchscreen face-down in the bezel. Leave the degaussing coil in place, if present. The degaussing coil is a hoop, often located between the CRT and bezel, approximately 1/4-inch (6 mm) thick, with a two-wire cable and connector. The coil was probably unplugged from the power supply earlier.
 - If the touchscreen will not fit flush against the lip of the bezel, do not force it. An interference fit between the edge of an AccuTouch touchscreen and some of the plastic ribs found in monitor bezels could result in fracture of the glass after reassembly.

- It may be necessary to cut the ribs and struts inside the bezel. Cutting these ribs and struts does not usually cause difficulties, although the stiffness of the bezel may be reduced slightly. Try not to cut into the posts for the CRT attachment screws. Bezel and tube combinations that require this cut are rare.
 - Generally, a total clearance between the edge of the touchscreen and any ribs or struts of at least 1/4-inch (6 mm) in both axes is necessary. This prevents the interference fit problem discussed above and allows for variation in touchscreen mounting position.
 - The potential interference between the degaussing coil and the touchscreen must also be evaluated. The coil will usually fit between the touchscreen and the inside surface of the bezel, as there is typically a natural cavity for it. If there is not enough space for the coil, you may have to provide additional setback for the CRT. It may also be possible to relocate the coil to the bell side of the CRT. Normally, this does not significantly reduce the coil's effectiveness. However, you must determine this by inspecting the monitor for color problems after reassembly.
- 1 Check for adequate clearance of the cable from the bezel structure. If the position of the cable causes difficulty, the touchscreen may be rotated 180° only if the touchscreen is sealed and Elo drivers are used. The preferred orientation of the AccuTouch touchscreen is with the cable exiting from the left side, when viewed from the front of the monitor. Rotation will cause an inversion of the output coordinates, which will be compensated for automatically by Elo driver software, but perhaps not by other drivers. (Flat touchscreens should have the plastic surface on the side facing the user.)

Installing the Touchscreen

CAUTION: After the touchscreen is attached to the CRT, transient protection must be in place before applying power to the monitor. Transient protection is discussed on page 4-34.



When preparing the touchscreen for mounting to the CRT, major considerations are:

- Reasonable mechanical alignment with the display.
- A complete dust seal between the touchscreen and the CRT.
- A mounting technique that evenly supports the touchscreen on at least two opposite edges. Elo recommends double-sided tape between the touchscreen and the CRT.

- Creating enough space between the CRT and the bezel to accommodate the touchscreen. Adequate spacing can normally be accomplished by:
 - 1 trimming or milling the inside of the bezel
 - 2 using spacers to move the CRT back in the chassis
 - 3 using spacers to move the bezel away from the touchscreen.

A combination of moving the CRT back with spacers and trimming the bezel is the usual solution.

- Depending on the touchscreen selected, avoidance of contact between the display bezel and the *active area* of the touchscreen may be necessary. The active area is that portion of the touchscreen inside the solid line. This "line" can be easily seen on the touchscreen itself as the edge of a piece of translucent material which is between the touchscreen glass and cover sheet. A small force applied to the cover sheet in the active area will produce contact between the glass and cover sheet registering a touch. A permanent touch, such as one produced by a bezel, will defeat the normal operation of the touchscreen. (It is permissible for the display bezel or a gasket to make permanent contact with the *inactive* border region of the touchscreen, and this often produces a more attractive solution.) Some AccuTouch touchscreens are sized so the active area is larger than typical bezel openings, so bezel contact often produces a touch.

Some of the popular touchscreen sizes are available with a wider inactive border region. This will allow you to install the touchscreen with the display bezel in contact with the touchscreen. The factors you should consider when selecting this installation method are:

- Spacer Selection - Spacers between the bezel and CRT cannot be eliminated using this method, and in fact should be chosen carefully. The desired result is to have the bezel just touch the touchscreen, but put little or no pressure on it.
- Sealing - Sealing touchscreens in the inactive border region will be easier. Caulks and gaskets of almost any type may be used to make a seal between the touchscreen and bezel in this region.

Double-sided tape and foam sealing tape are included in the Elo touchscreen installation kit (P/N 458095-000). The following steps assume you will use these materials to mount the touchscreen to the CRT.

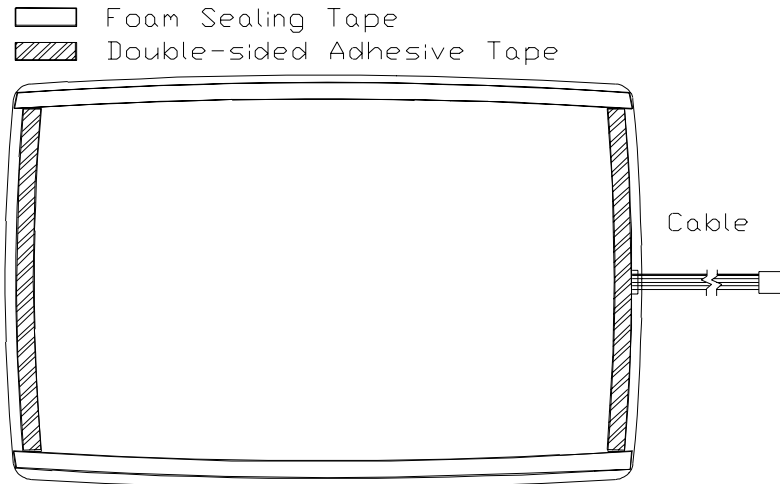

Figure 4.3 Rear View of an AccuTouch Touchscreen with Mounting Materials

Before mounting the touchscreen, clean the face of the monitor and the back of the touchscreen with household glass cleaner. Be sure to remove all fingerprints. The space between the touchscreen and the monitor face must be clean and free of any foreign objects.

Mount the touchscreen as follows:

- Use two layers of the double-sided adhesive tape to achieve a total thickness of 1/16-inch (2 mm). While specific touchscreen and CRT combinations may allow the use of thinner materials, 1/16-inch (2 mm) is generally necessary to allow for variations in ROC between the two glass surfaces. Review the fit between the touchscreen and the CRT before applying the tape. If one pair of opposite edges has a closer fit than the other, put the adhesive tape on the edges of the touchscreen with the better fit. See figure 4-2 for typical placement. If there is a good fit on all four edges, you may want to use double-sided adhesive tape on all four edges. When doing this, move the adhesive tape in slightly on one pair of edges and add foam sealing tape outside these two edges. The thicker foam tape will keep the adhesive tape away from the CRT until you are ready to adhere the touchscreen to the monitor.

In general, the adhesive tape should be set back slightly from the edge of the active area of the touchscreen. When the monitor is reassembled, the mounting tape should not be visible. Do not remove the liner from the exposed side of the adhesive tape yet.

- Cut and place the foam sealing tape on the back of the touchscreen to form a dust seal as shown in Figure 4.2 on page 4-22. This seal is particularly important because the CRT is a good electrostatic precipitator and will attract dust. The adhesive tape and foam sealing tape should form a complete seal around the touchscreen. Do not leave any gaps. The sealing tape should not be visible when the monitor is reassembled.
- Practice aligning the touchscreen on the CRT without removing the adhesive tape liner. The installation can tolerate some horizontal and vertical shift. However, rotational skew between the touchscreen and monitor axes cannot be easily compensated for in the calibration, and will also interfere with proper mounting of the tube in the bezel.
- When you have a good feel for the placement of the touchscreen, clean the back side of the touchscreen and the face of the CRT again. Avoid all contact between the cleaning solution and the mounting materials as the cleaner may cause the mounting materials to eventually release from the glass. Remove all lint with a brush or compressed air. Remove the liner from the adhesive tape and align the touchscreen on the monitor. The thicker foam tape will keep the adhesive tape away from the CRT until you are ready to adhere the touchscreen to the monitor. Now press the touchscreen firmly against the CRT.
- Inspect your results carefully for alignment, trapped dust or lint, and a good seal between the touchscreen and CRT. If there is trapped lint, you may be able to remove it without removing the touchscreen by capturing it with a thin wire with a small spot of glue. Poke the wire through the foam gasket and stick the lint to the wire. Pull the lint back into the gasket and embed it there, or remove it completely and reseal the gasket.
- If you must remove the touchscreen from the CRT, cut the adhesive tape away with a sharp thin blade, such as an X-Acto knife. The touchscreen glass will probably break if you try to pull it off by a corner or an edge. Shave the old adhesive tape from the touchscreen and CRT with the knife. Adhesive residues can be removed with isopropyl alcohol, which will leave streaks and fingerprint smears. Use glass cleaner for the final cleaning prior to reapplication of new tape.

Spacing the CRT from the Bezel

The last part of the touchscreen mounting procedure is to determine the appropriate spacing of the CRT from the bezel, (with the touchscreen attached), and to reinstall the CRT with the required spacers in place (refer to, Figure 4.1 on page 4-21.) ***Do not clamp the touchscreen between the bezel and the CRT without proper spacers as breakage will almost certainly occur.*** The nominal thickness of the touchscreen and the two layers of adhesive tape is 3/16-inch (5 mm). If your installation has a 1/8-inch (3 mm) touchscreen-to-bezel gap, 5/16-inch spacers would be required. If the touchscreen is to be in contact with the bezel, 3/16-inch (5 mm) nominal spacers would be required.

Because the original CRT face-to-bezel mount is often an interference fit, with the bezel shape altered slightly to draw it up tightly against the CRT, you should start with a 1/16-inch (2 mm) thicker spacer than the nominal dimension above. Two thicknesses of spacers, plus additional washers to use as shims, are available in the Touchscreen Installation Kit (458095-000).

During the spacer selection process, you may have to install the CRT with the touchscreen attached in the bezel several times. To prevent the CRT from dislodging the spacers, temporarily insert plastic tie wraps or toothpicks as guides in the mounting post holes. After selecting the correct spacers, discard the guides and fix the spacers more securely in place with the adhesive "doughnuts" provided in the Touchscreen Installation Kit.

When spacers for the desired gap have been selected, install the CRT. Make sure you have previously reinstalled the degaussing coil. Select a screw that is long enough to compensate for the spacer thickness (provides at least three full turns into the mounting post threads) but not so long as to penetrate the surface of the bezel. Over-tightening the screws may strip or split the mounting posts.

After the screws have been tightened snugly, examine the clearance between the bezel and touchscreen. Try to adjust for the clearances suggested unless the available space is insufficient.

If you are trying for zero clearance between the touchscreen and the monitor (using a wider inactive region touchscreen), the above process should still be generally followed. ***Do not clamp the touchscreen between the bezel and the CRT with no spacers as breakage will almost certainly occur.***

Evaluate the bezel to touchscreen fit carefully. Before selecting spacers, check the fit by placing the bezel over the touchscreen/CRT combination (using the plastic waste bucket to hold the CRT), or gently setting the touchscreen/CRT combination on top of the inverted bezel on the workbench. Look for reasonably even fit. If the bezel in its relaxed state has a different curvature than the touchscreen, this method may not work, and you may want to complete the installation with a gap between the touchscreen and bezel as described earlier.

Select spacers to allow the touchscreen to just touch the bezel. If the bezel is in contact in some areas and not in others, be wary of warping the bezel to achieve uniform contact by using thinner spacers. While mounting tape will provide some compliance and the touchscreen may also flex slightly, shipping damage may occur.

Transient Protection

WARNING:  Lack of transient protection may produce a dangerous shock hazard. Touchscreen damage resulting from transient discharge is not covered by the Elo warranty. Procedures discussed in this section must be followed to maintain safety and assure reliability of the touchscreen system.

When an AccuTouch touchscreen is installed on a monitor, the combination becomes a capacitor which stores an electric charge. The simplest capacitors are parallel plates of conductive material separated by an insulating material called the dielectric. In this case, the plates are the metallized coatings of the touchscreen and the CRT face, and the dielectric consists of the various air and glass layers between them. See Figure 4.3 on page 4-30 . The capacitance increases with the size of the plates and closer spacing.

The potential on the inside face of the CRT can be more than 30,000 volts. When the monitor is turned on or off, a large difference in charge builds up between the two plates (mainly C1 in Figure 4.3 on page 4-30). To balance the charge, some current must flow from the system ground to the touchscreen. If this current does not flow, the potential on the touchscreen rises until sufficient potential exists to cause an arc. This arc can damage the touchscreen or cause a dangerous electrical shock. Transient protection provides a safe, controlled path for this current by limiting the voltage buildup on the touchscreen.

Elo recommends connecting the cathodes of four transient suppression diodes to the four glass substrate terminals of the touchscreen. Make the connection as close to the touchscreen as possible. The anode end of all four diodes must be attached to the CRT chassis ground through a short wire of the largest possible diameter (16 gauge or heavier recommended). See Figure A.3 on page A-64, for a circuit diagram.

In monitor installations where the touchscreen controller will be external to the monitor, use the Elo transient protection cable (899389-000), included with the touchscreen kit. You must attach the transient protection component(s) to the touchscreen cable and connect the ground wire to the monitor's chassis ground before turning the monitor on. The controller need not be connected to the touchscreen.

In monitor installations where the touchscreen controller will be installed internal to the monitor, the serial controller's on-board transient protection may be used. The touchscreen must be connected to the controller and controller grounded through one of the plated-through mounting holes before turning the monitor on.

Some form of transient protection must be connected at all times. If you cannot use one of the recommended solutions, contact Elo Technical Support for alternatives.

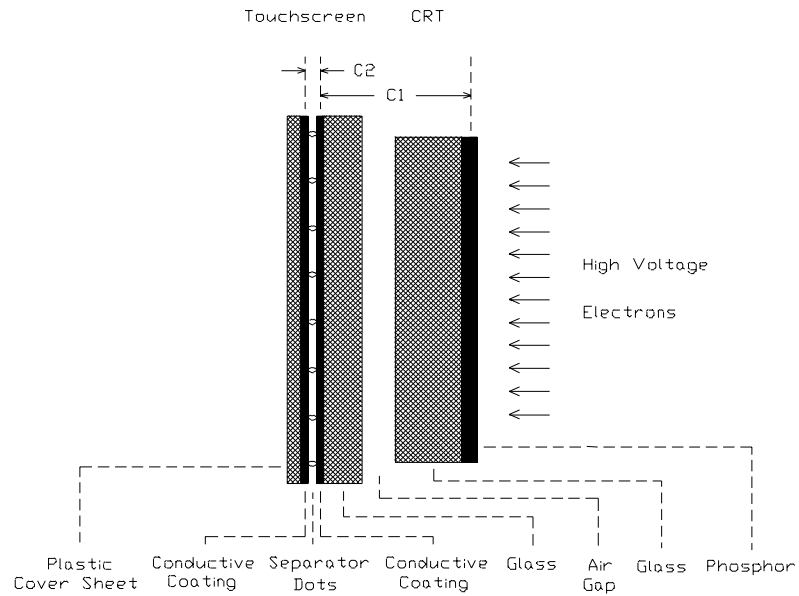

Figure 4.4 Side View of an AccuTouch Touchscreen Installation

Controller Interface Options

Elo offers PC-Bus and serial (RS-232) controllers for AccuTouch touchscreens. The serial controller may be purchased in a Tabletop enclosure (see Chapter 3) or as components. This section includes a procedure for installing a CTR-221000-AT-SER serial controller inside the monitor.

Regardless of the configuration of touchscreen and controller, you are responsible for any recertification for agency approvals (FCC, UL/CSA, TÜV, CE, etc.) that may be necessary for your application.

Internal Controllers

An AccuTouch internal controller mounting kit is available from Elo. P/N 734849-000 is for use with 2210 controllers. P/N 310900-000 is for use with 3000U controllers. These kits are useful together with the touchscreen installation kit (P/N 458095-000) for identifying preferred materials for your own procurement. The controller mounting kit may also be cost-effective and convenient when purchased for a limited number of installations.

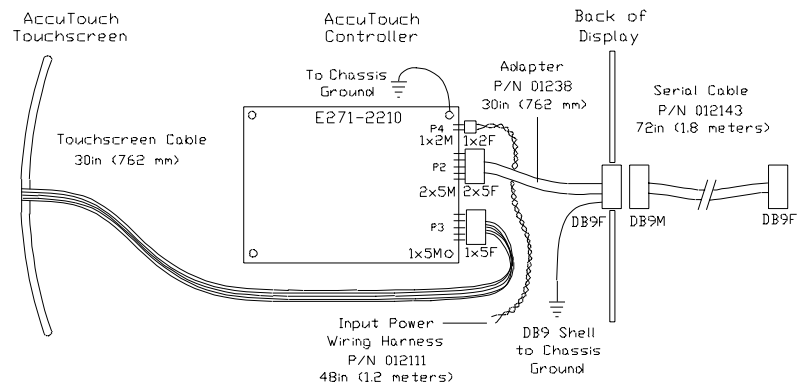

Figure 4.5 Touchscreen Cabling System for Internal Serial Controller

2210 Serial Controller and 3000U USB Controller

The mounting holes of the 2210 serial controller and the 3000U USB controller are sized for 0.156-inch (4mm) snap-in standoffs. All AccuTouch touchscreens have a cable termination that mates directly with the male header (P3) on the controller. See Appendix B for specific mounting dimensions and connections.

Mounting an internal serial controller presents some challenges:

- Space for the controller and the cable headers, and for any additional shielding that may be required to prevent noise and crosstalk between the monitor and the controller. Noise can cause instability in the touch data or other forms of intermittent operation.

- Space for an internal +5 Vdc power supply if required. The 2210 controller power requirements are: 65 mA @ +5Vdc \pm 10% standby, 160 mA average with touch, 240 mA peak. Elo offers a 100 to 240 Vac international power supply (P/N 742067-000) for use with the AccuTouch serial controller. The 3000U USB controller does not require a power supply as it gets its power from the USB bus. See the *SmartSet Touchscreen Controller Family Technical Reference Manual* available at www.elotouch.com/support/dwnldmnl.asp for specific power requirements and connections for the 2210 controller and www.elotouch.com/products/accutec/c3000u.asp for specific power requirements and connections for the 3000U controller.
- Cable routing that may contribute to noise and crosstalk.
- Electromagnetic Interference (EMI) suppression. Installing a touchscreen and controller will affect the EMI characteristics of the monitor.
- Heat dissipation. The 3000U controller dissipates about 0.25 watt. The 2210 controller dissipates about 0.3 watt. A typical power supply, if required, may dissipate several watts more. This places an additional load on the cooling system of the display. The available locations to mount a controller and power supply may also affect the cooling system of the display.

Both the serial and USB controller have transient protection on-board. Mounting the controller internally is the only instance where this on-board transient protection can be substituted for the transient protection solutions discussed in the previous section. *When using the on-board protection, you must insure that the touchscreen is connected to the controller and the controller is grounded when cycling power to the display.* The 2210 has two plated-through mounting holes, and its on-board transient protection is grounded through them. The 3000U has four plated-through holes, and its on-board transient protection is grounded through them. You must connect chassis ground to at least one of these plated-through holes.

Installing the 2210 Serial Controller

Complete these steps to install the 2210 controller, using the internal controller mounting kit (P/N 734849-000):

- 1 Be sure all controller jumper settings are made prior to installation. See Appendix B.
- 2 Once proper component positioning has been determined, insert the desired profile standoffs into at least three of the mounting holes, but do not peel off the adhesive backing. Wait until some of the following steps are accomplished:

- 3** Enable the controller's on-board transient protection. This may be accomplished one of two ways:
 - If the controller can be mounted to a metal chassis, it can be grounded through one of the plated-through mounting holes by using one of the No. 6 sheet metal screws and spacers provided in the kit. Use either of the holes marked "PTH" in Figure B.2 on page B-71 .
 - If the controller cannot be mounted to a metal chassis, use a ground wire with a lug attached to connect one of the controller's plated-through mounting holes to chassis ground.

When using the controller's on-board transient protection, you must ensure that the touchscreen is connected to the controller and the controller is grounded when cycling power to the monitor.

- 1** Connect the power cable harness to the 1x2 male connector at P4 on the controller. Connect the power source to the harness and then to AC. The 2210 controller power requirements are +55 mA at +5 Vdc \pm 10% standby, 160 mA average with touch, 240 mA peak.
- 2** Connect the 2x5 female connector on the serial output cable to the 2x5 male connector at P2 on the controller. Mount the DB9 female end of the cable as described for the 899389-000 cable in the following section. The serial cable connector shell must be grounded to satisfy safety agency approvals, as the grounding protects the user in case a wiring fault develops in the monitor. Attach the other ground wire supplied in the kit to one of the DB9's mounting screws and the other end to chassis ground if the shell is not already grounded.

Mechanically, there may be several options for mounting the bulkhead connector on the monitor case:

- Mounting the cable to a chassis member that is exposed to the display exterior. This requires a DB9 hole punch to mount the connector neatly, but makes reassembly of the back of the case very easy, and is usually the best functional and cosmetic solution.
- Mounting the cable to a concealed chassis member, with a hole in the exterior of the case (usually plastic) to provide access to the connector. This technique also requires a metal punch to mount the DB9 connector, but the plastic case hole can often be routed, nibbled, or punched with simple tools, and usually provides a neat appearance. This is also an excellent functional solution as the back case is again very simple to reassemble.

- Mounting the cable to the plastic case. Plastic cases are usually rather thick, making it necessary to mount the flange of the connector on the outside of the case. This is cosmetically less acceptable than an inside mount and there is less support for the serial cable. Also the standard DB9 hole may not provide adequate clearance for the connector. Avoid mounting to curved surfaces if possible as hole punching is more difficult and mounting hardware will warp the connector when tightened. If mounted on the inside, the mounting hardware may interfere with proper mating with the P/N 899389-000 cable. Also, the touchscreen cable must be connected to the P/N 899389-000 cable as the back case is being reinstalled, and the ground cable from the transient protection must also be connected. The shell of the DB9 connector is internally connected to the ground wire.

An escutcheon, or identifying metal plate labeled with the legend "Touch Interface" (P/N 172001), is included in the touchscreen installation kit (P/N 458095-000). It provides an attractive and convenient finish to most of the bulkhead mounts typically used on a display. A similar plate is also available with vertical labeling (P/N 172003).

Installing the 3000U USB Controller

Complete these steps to install the 3000U USB controller, using the internal controller mounting kit (P/N 310900-000):

- 1** Once proper component positioning has been determined, insert the desired profile standoffs into at least three of the mounting holes, but do not peel off the adhesive backing. Wait until some of the following steps are accomplished.
- 2** Enable the controller's on-board transient protection. This may be accomplished one of two ways:
 - If the controller can be mounted to a metal chassis, it can be grounded through one of the four plated-through mounting holes by using a No. 6 sheet metal screw and an appropriate sized spacer.
 - If the controller cannot be mounted to a metal chassis, use a ground wire with a lug attached to connect one of the controller's plated-through mounting holes to chassis ground.

When using the controller's on-board transient protection, you must ensure that the touchscreen is connected to the controller and the controller is grounded when cycling power to the display.

- 3 Mount the USB I/O assembly (PN 250103) at the back of the display. The USB I/O assembly connector shell must be grounded to satisfy safety agency approvals, as the grounding protects the user in case a wiring fault develops in the display. Attach the ground wire supplied in the kit to one of the USB I/O assembly's mounting screws and the other end to chassis ground if the shell is not already grounded.

Note: The USB I/O assembly will fit the same size cutout as a DB9 connector.

Mechanically, there may be several options for mounting the bulkhead connector on the display case:

- Mounting the assembly to a chassis member that is exposed to the display exterior. This requires a DB9 hole punch to mount the connector neatly, but makes reassembly of the back of the case very easy, and is usually the best functional and cosmetic solution.
 - Mounting the assembly to a concealed chassis member, with a hole in the exterior of the case (usually plastic) to provide access to the connector. This technique also requires a metal punch to mount the DB9 connector, but the plastic case hole can often be routed, nibbled, or punched with simple tools, and usually provides a neat appearance. This is also an excellent functional solution as the back case is again very simple to reassemble.
 - Mounting the assembly to the plastic case. Plastic cases are usually rather thick, making it necessary to mount the flange of the connector on the outside of the case. This is cosmetically less acceptable than an inside mount and there is less support for the serial cable. Also the standard DB9 hole may not provide adequate clearance for the connector. Avoid mounting to curved surfaces if possible as hole punching is more difficult and mounting hardware will warp the connector when tightened. If mounted on the inside, the mounting hardware may interfere with proper mating with the 18-inch USB cable (P/N 793054-000).
- 4 Connect one end of the 18-inch USB cable to connector P2 on the controller and the other end to the internal connector on the USB I/O assembly.

An escutcheon, or identifying metal plate labeled with the legend "Touch Interface" (P/N 172001) is included in the touchscreen installation kit (P/N 458095-000). It provides an attractive and convenient finish to most of the bulkhead mounts typically used on a display. A similar plate is also available with vertical labeling (P/N 172003).

External Controllers

Installing the 2210MX Serial Controller

Using the 2210MX external serial controller may simplify the overall integration process.

Begin by deciding where to mount the controller on the rear of the display case. The dimensions of the enclosure are 4.14 in x 2.34 in x 0.9 in. Provide room for easy access and installation of all cables.

Complete the following steps to install the controller:

- 1 After choosing a location, drill a 0.625-inch diameter hole for cabling exiting the display and drill two holes for screws that will be mounted in the display case.
- 2 After you drill the holes, route the transient suppression cable (P/N 484815-000) out through the 0.625-inch diameter hole in the display case.

Note: Transient suppression cables should always be used unless you are using an LCD display.

- 3 Attach the 1x5F connector on the transient suppression cable to the 1x5M header at P3 on the controller.
- 4 Mount the 2210MX to the display case.
- 5 Connect the 1x5F connector on the touchscreen cable to the 1x5M connector on the transient suppression cable.
- 6 Connect the ground wire of the transient suppression cable to an appropriate ground inside the display.
- 7 Pull any excess cabling back into the display case.
- 8 Reattach the case to the monitor.

Complete the following steps if you are using a **wall mount power supply**:

- 1 Two different wall mount power supplies are available. Use P/N 580979-000 if you are using this inside the United States and P/N 319865-000 if you are using this outside of the United States.
- 2 Plug the single male connector on one end of the power supply into the connector on the serial cable.
- 3 Plug the other end of the power supply into a proper receptacle.
- 4 Plug the DB9F end of the attached serial cable into a serial port.
- 5 Proceed to “Where to Go from Here” on page 3-18.

Complete the following steps if you are using a **keyboard power tap**:

Caution: Before using a keyboard power tap, be sure sufficient power is available for the touchscreen controller or damage may occur to the computer.

Caution  Before connecting a keyboard power tap to the controller, be sure that power to the computer is OFF. Connecting a keyboard power tap to a powered computer may seriously damage the computer or the controller.

- 1 Two different keyboard power taps are available. Use P/N 980773-000 if you have a standard keyboard connector and P/N 388923-000 if you have a PS/2 keyboard connector.
- 2 Unplug the keyboard from the computer.
- 3 Plug the male connector on the Y end of the adapter cable into the keyboard connector on the back of the computer.
- 4 Plug the keyboard cable into the female connector on the Y end of the adapter cable.
- 5 Plug the other end of the adapter cable into the connector on the serial cable.
- 6 Plug the DB9F end of the attached serial cable into a serial port.
- 7 Proceed to “Where to Go from Here” on page 3-18.

Installing the 2201 PC-Bus Controller

Using the 2201 PC-Bus controller may simplify the overall integration process.

Complete the following steps to install the controller:

- 1 Install the 6-inch (152 mm) internal interface cable (P/N 899389-000) that connects the touchscreen to the display case. This cable is available separately from Elo. This cable contains transient protection as described earlier. Its ground cable must be attached to chassis ground to achieve proper transient protection.

The termination of the internal cable is a DB9M connector. An external 6-foot (1.8 meter) cable (P/N 454173-000) is available separately from Elo and extends the connection to the controller.

Mechanically, there may be several options for mounting the bulkhead connector on the display case:

- Mounting the P/N 899389-000 cable to a chassis member that is exposed to the display exterior. This requires a DB9 hole punch to mount the connector neatly, but makes reassembly of the back of the case very easy, and is usually the best functional and cosmetic solution.

- Mounting the P/N 899389-000 cable to a concealed chassis member, with a hole in the exterior of the case (usually plastic) to provide access to the connector. This technique also requires a metal punch to mount the DB9 connector, but the plastic case hole can often be routed, nibbled, or punched with simple tools, and usually provides a neat appearance. This is also an excellent functional solution as the back case is again very simple to reassemble.
- Mounting the P/N 899389-000 cable to the plastic case. Plastic cases are usually rather thick, making it necessary to mount the flange of the connector on the outside of the case. This is cosmetically less acceptable than an inside mount and there is less support for the external P/N 454173-000 cable. Also the standard DB9 hole may not provide adequate clearance for the connector. Avoid mounting to curved surfaces if possible as hole punching is more difficult and mounting hardware will warp the connector when tightened. If mounted on the inside, the mounting hardware may interfere with proper mating with the P/N 899389-000 cable. Also, the touchscreen cable must be connected to the P/N 899389-000 cable as the back case is being reinstalled, and the ground cable from the transient protection must also be connected. The shell of the DB9 connector is internally connected to the ground wire.

An escutcheon, or identifying metal plate labeled with the legend "Touch Interface" (P/N 172001) is included in the touchscreen installation kit (P/N 458095-000). It provides an attractive and convenient finish to most of the bulkhead mounts typically used on a display. A similar plate is also available with vertical labeling (P/N 172003).

P/N 454173-000 is a shielded, 9-pin, straight-through extension cable. Other common computer data cables may be substituted. Contact Elo if special requirements exist that cannot be satisfied with a standard cable configuration.

- 2 To complete the installation go to "PC-Bus Controller" on page 3-15.

Routing the Touchscreen Cables

The internal cable(s) that carry the analog touchscreen signals are subject to interference from various sources within the monitor. The routing of these cables should avoid the following areas, listed in order of importance:

- the flyback transformer
- the anode lead
- the inverting section of the power supply (most monitor power supplies are switching power supplies, and the main DC to AC inversion section produces most of the noise).
- the yoke
- the RGB video drive section of the monitor.
- the video input cable.
- the horizontal and vertical oscillator/drive sections
- the degaussing coil wiring.

Obviously, it may not be possible to avoid all these areas simultaneously. Watch carefully for fluctuation in the touch coordinates when a stationary touch is applied which would indicate potential noise problems. Once acceptable cable positioning is determined, tie the cable down to avoid movement during shipment.

In addition to careful cable routing, other EMI suppression techniques may be necessary to satisfy agency approval requirements. Use ferrite beads or other radio frequency (RF) suppression elements, additional shielding, and different grounding techniques as needed.

Reassembling the Monitor

With the touchscreen mounted, and the cable routing and exterior interface determined, the monitor must be reassembled. Reassembly is generally in reverse order of disassembly. Beware of potential clearance problems between the bell of the CRT and the electronics chassis, as shorts in this area can produce catastrophic failures of the monitor. Also, if the inside surface of the back case is painted with a conductive coating, watch for shorts between the CRT circuit board and the rear of the back case, as these can also produce disastrous results.

When the electronics chassis is reinstalled, the CRT circuit board is usually carried along with it. It is often advisable to have a second person assist you, to insure that this circuit board and various other cables do not interfere with the yoke or neck of the CRT. *Safety glasses, gloves, heavy protective clothing, and caution are strongly advised for all participants.*

Reconnect all cables that were removed during the disassembly procedure. Watch for single ground connections from the CRT mount to the chassis, between individual chassis members, etc., which may have lugs and screws to connect them, or sometimes individual push-on solderless connectors. *Failure to reconnect these important cables may result in improper performance of the monitor after reassembly and may render the unit unsafe.*

Re-glue the CRT circuit board to the connector with an electronic-grade (non-corrosive) silicone adhesive (such as GE RTV-162). Discharge the CRT again (see “Discharging the CRT” on page 4-25), and then reconnect the anode lead to the anode button, making sure the spring hooks catch inside the hole.

If practical, test the monitor and touchscreen at the earliest time possible before reassembling the monitor, as the reassembly of the back case can be tedious. If mistakes have been made, corrections are easier to make if the covers are still off. Make sure, however, if you are using the 899389.000 cable for transient protection, that the ground lead is connected to chassis ground of the monitor and the cable is connected to the touchscreen.

Finally, remove any agency certifications (UL, CSA, FCC, TÜV, CE, etc.) for which you have not resubmitted.

Sealing the Monitor

If dirt and dust seals are all that are necessary for your application, you may easily apply open cell foam material, similar to that used between the touchscreen and the monitor, between the touchscreen and the bezel. If the seal contacts the active area of the touchscreen, avoid compression of the seal sufficient to change the open circuit resistance. This can be monitored during installation by connecting an ohmmeter between pins 1 and 3 of the touchscreen cable.

Watertight seals are achievable by gasketing around the inactive border region of the touchscreen. Caulks and elastomer gaskets of almost any type may be used to make a seal between the touchscreen and bezel in this region. Caulks can be used over the active area of the touchscreen as long as force on the bezel is not transferred to the touchscreen. Gaskets can only be used if the active area is within the bezel opening. These types of seals can meet NEMA 4 and 12 standards.

Flat Panel Display Integration

While much of this chapter applies specifically to touchscreen integration on CRT-based monitors, most of it also applies to integration on liquid crystal monitors (LCD's), electroluminescent (EL) monitors, and plasma monitors. However, there are additional specific issues when integrating each type of flat panel monitor:

- **Transient Protection** - Additional transient protection beyond what is provided by an Elo touchscreen controller is not necessary.
- **Optical Filters** - While it is common to incorporate a circular polarizer with an EL monitor, the CP filter may not be necessary because the touchscreen provides much of the needed contrast enhancement.
- **Mechanical** - To prevent touchscreen breakage, there should be a compliant gasket between the back of the touchscreen and the front of the monitor to allow for variation in the surfaces when assembling. A gap is also required between the touchscreen and the face of an LCD to prevent damage to the monitor.
- **Heat** - Unlike CRT's, plasma, and EL monitors, backlit LCD's may be a significant source of heat. The situation may be more significant if the unit is sealed. Any installation must avoid heat rise that exceeds the touchscreen specification.

Where to Go from Here

The touchscreen component installation is now complete.

If you must ship your touchmonitor, remember that monitor manufacturers' cartons are rarely satisfactory for more than one trip. The monitor's mechanical strength may have been compromised by the touchscreen installation. You should consider designing your own carton based on drop tests of the monitor with the touchscreen installed, or overpacking the original carton with your own.

Return to Chapter 3 for instructions on connecting the touchmonitor to your computer.



TROUBLESHOOTING GUIDE

If you experience operational difficulties with the touchscreen system either during or after installation, the following sections will help you determine the source of the problem.

The Troubleshooting Process

The first step in troubleshooting a touchscreen system is to determine whether the problem is related to the display, software, or hardware:

- Do not confuse display problems with touchscreen problems—the two are unrelated.
- Software problems are determined by a basic hardware functionality test. If the hardware transmits touch coordinates correctly, then the problem is with the driver or application software.
- Hardware problems may be caused by the touchscreen, controller, cabling, power supply, or by the integration of the touchscreen components in the display. This appendix describes techniques for isolating the problem, including power-on diagnostics, status LED verification, and component swapping.

Display Problems

If you are experiencing display problems (such as no video, no horizontal or vertical synchronization, raster non-linearities, etc.), remember that the video function of the display and the Elo touchscreen installed on the display are separate systems. Therefore, problems with the display should be treated as display problems, not touchscreen problems. Diagnostic procedures and possible corrections for display problems should be performed using the troubleshooting procedures outlined in your display manual.

The AccuTouch touchscreen is powered from its controller. Usually the display and touchscreen controller have separate power supplies and operate independently. Thus it is possible for the touchscreen to interact with the computer even if the display is powered off. Internal serial controllers may be powered by a supply that is separate from the display's power supply, but controlled through the display's power switch. In this case, even if display problems exist, the touchscreen system will probably function if the display power switch is on.

Software Troubleshooting

Before beginning software troubleshooting, verify that the touchscreen hardware is working by running the COMDUMP program for serial controllers (see “Using the COMDUMP Utility” on page A-57) or the BUSSTAT program for PC-Bus controllers (see “Using the BUSSTAT Utility” on page A-62). If the touchscreen is operating, then the problem may be with the driver software, the application software, or a conflict with other hardware or software. (The problem may also be due to incorrect touchscreen video alignment, see “Video Alignment Problems” on page A-51.)

The general technique for troubleshooting software problems is to identify at what layer of software and associated hardware the problem exists. For example, if you have a Windows application, there are several layers of software and drivers. The problem could be with your application, Windows, MonitorMouse for Windows, MonitorMouse for DOS, the ELODEV driver, a conflict with another device, or the touchscreen hardware. The best approach to software troubleshooting is to remove the layers of software one by one, testing each layer until the problem is isolated. Also, try removing other hardware and software that may be conflicting with the touchscreen hardware and driver software.

Video Alignment Problems

If the touchscreen is responding and the data is linear, but a touch does not activate the appropriate zone in the application, try realigning the video. Use ELOCALIB under DOS or the Touchscreen Control Panel with all versions of MonitorMouse. Improper video alignment may be indicated when the cursor does not move at the same pace as a sliding finger, or when it moves in the opposite direction. The cursor should always move in the same axis as your finger.

If you have a DOS application, erase any ELOGRAPH.CAL files and repeat video alignment process in the video mode used by your application. For example, you may have a VGA monitor with your application running in text mode, so perform video alignment in text mode rather than graphics mode.

Hardware Troubleshooting

Troubleshooting the touchscreen system hardware may require analysis of the touchscreen, controller, cables, power supply, and the integration process. The best place to start is with the controller.

Use the controller power-on diagnostics which are displayed when the Elo driver software is loaded to check for specific faults (see “Diagnostic Codes” on page A-66). If accessible, the controller’s diagnostic LED’s may identify a problem (see “Diagnostic LEDs” on page A-64).

Also, check whether the controller is transmitting any touch data. Use the COMDUMP program for serial controllers (see page A-57), or the BUSSTAT program for PC-Bus controllers (see page A-62). You may encounter one of the following symptoms:

- **Constant touch data.** If touch data is reported continuously, the most likely problem is constant physical touch on the active area of the touchscreen, usually from contact with the display bezel. When using ELODEV 1.5 or later, a warning at installation will appear with some controllers. This condition can be verified with BUSSTAT for bus controllers, and COMDUMP for serial controllers. (See “Software Troubleshooting” on page A-50.)

If an external serial controller is being used, disconnect the touchscreen cable from the controller (the input to the controller, not the output to the COM port) while COMDUMP is scrolling data.

If the constant touch data continues, the problem is controller related. If the touch data stops and then reappears when the touchscreen is reconnected, the problem is bezel contact, or a shorted touchscreen or cable. Inspect the bezel for clearance, and adjust the touchscreen or display mounting if necessary. See “Touchscreen Diagnosis” on page A-53, for analysis of touchscreen problems, and “Touchscreen Cables” on page A-63, for cable pinouts.

- **No touch data.** When no touch data is reported, the problem may be the touchscreen, controller, or cabling. The “paper clip” test may be used to eliminate some of these possibilities. With the appropriate driver or diagnostic software loaded, connect a straightened paper clip or other suitable wire to the controller input as follows:
 - **Serial Controller** - Connect a wire jumper between pins 2 and 3 or 3 and 4 at connector P3 on the controller board. If you have a touchmonitor with an internal serial controller, it may not be easy to perform this test. Limited diagnostics can be performed by looking at the RS-232 output. See “RS-232 Connections” on page A-59.

If you have a TouchMonitor with an internal serial controller, it may not be easy to perform the paper clip test. Limited diagnostics can be performed by looking at the RS-232 output. See “Serial Controller” on page A-57.

If you are working inside a display with the touchscreen installed, it is not necessary to disconnect the touchscreen when performing this test. If the touchscreen is disconnected, ensure that transient protection is still connected to the touchscreen. If separate transient protection has not been used and you are disconnecting the touchscreen from the controller, ground all five pins of the touchscreen cable to chassis ground of the display.

- **Bus Controller** - Connect the wire jumper between pins 1 and 6 or 1 and 7 of the DB9 female connector on the controller or to the same pins of the touchscreen cable. See Figure A.4 on page A-67.

The result of this test for either style of controller will be continuous transmission of touch data if the controller and its link to the host are working. The values for X or Y will be at or near the maximum value of 4095 for both serial and bus controllers depending on the connection you have made.

If an extension cable was used for the paper clip test and the controller did not respond, the touchscreen cable may be at fault. Move the paper clip to the connector on the controller and repeat the test. See “Touchscreen Cables” on page A-63.

A lack of response to the paper clip test points to a faulty controller, controller setup, power supply, or cables. See “Serial Controller” on page A-57, or “Bus Controller” on page A-62.

If the system responds to the paper clip test, the touchscreen or the cabling between the touchscreen and your test point is at fault. See “Touchscreen Diagnosis” on page A-53, for further troubleshooting.

- **Linearity.** If touch data is being reported, but the system linearity is poor, the problem can be in any touch component. Do not confuse linearity problems with improper video alignment. Video alignment errors can cause progressive offsets in the reported touch location versus your actual point of touch, even in the opposite direction, but never orthogonal to the direction of movement. Random responses may be due to improper controller setup.

If your problem is linearity and not video alignment or setup, investigate cables next. A cable with one drive wire (connected to pins 1, 2, 4, or 5 of the touchscreen) disconnected, or open, will produce non-linearity that gets progressively worse as you move toward the corner associated with it. This problem can be verified with an ohmmeter. See “Touchscreen Cables” on page A-63.

It is also possible for a shorted transient protection component to produce the same type of symptom. Verify that all four transient suppression diodes are functional if an open in the cable cannot be found. These components fail shorted, and should be easy to spot with an ohmmeter. See “Transient Protection Components” on page A-64.

If linearity is poor in several areas, and you can verify that cables are satisfactory, the touchscreen may have been damaged by lack of transient protection. See the following section, “Touchscreen Diagnosis”.

Touchscreen Diagnosis

The easiest way to verify touchscreen failure is by substitution. This eliminates the need to make any measurements or to concoct a dummy touchscreen. Touchscreens of any size may be driven by the same touchscreen controller. A substitute touchscreen may be used on the desktop or held up in front of the display temporarily to try to verify the source of the problem. The video alignment will normally differ for each touchscreen.

Before disconnecting the original touchscreen, make sure that transient protection has not been disconnected. If nothing else is available, ground all five pins of the touchscreen that has been disconnected while you are substituting another unit. See “Transient Protection Components” on page A-64, for further details.

Since the gross function of the touchscreen is that of a switch, this characteristic can be observed. Connect an ohmmeter between pin 3 and any of pins 1, 2, 4, or 5 of the touchscreen cable. This should show an open circuit (>1 megohm) when the touchscreen is not being touched, and <1000 ohms when touched in the middle of the touchscreen with firm finger pressure. A resistance of less than 5000 ohms will usually register a touch with a controller. Resistances up to 200 kilohms without a touch will cause linearity problems, as the touchscreen system effectively averages a deliberate touch with the problem area. When these low resistance values are observed, look for bezel contact in the active area or damage to the cover sheet of the touchscreen.

If the bezel is touching, adjust the mounting. If damage is suspected, monitor the resistance as described above while pulling gently on the cover sheet at the damaged location with a piece of tape stuck to the touchscreen. The resistance will increase to the normal open circuit value if the correct spot has been identified. It is possible, in some circumstances, to correct touchscreen shorts that result from damage to the cover sheet. Contact Elo Technical Support for assistance.

There are additional resistance measurements that can reveal other problems. Referring to Figure 2.1 on page 2-6, corner-to-corner touchscreen resistances should be similar (within about 10%) between the following pins:

| | |
|----------|------------|
| 1-2, 4-5 | (H-X, Y-L) |
| 1-4, 2-5 | (H-Y, X-L) |

Most touchscreens will have resistances between 50 and 100 ohms. Also, the resistances are usually proportional to the relative distances between the corners for a particular size of touchscreen. Thus the H-Y and X-L readings are usually larger than H-X and Y-L. *Do not count on consistent resistance values from touchscreen to touchscreen.* In general, large variations in resistance pairs, or absolute values above 120 ohms indicate a faulty touchscreen. Touchscreens with this type of damage are not repairable.

Touchscreen Simulation

The action of the touchscreen can be simulated with a variety of circuits, several of which are described below. A dummy touchscreen can be useful in troubleshooting when many systems are being maintained or when controller linearity is suspected.

The simplest dummy touchscreen is the “paper clip test” described on page A-52. Another simple dummy touchscreen is shown in Part I of Figure A.1 on page A-56. This circuit will produce the action of a constant touch in the middle of a real touchscreen. The coordinates that the controller outputs will be about 2000,2000 when using ELODEV uncalibrated and the TOUCHES diagnostic utility. This circuit can also be modified by adding a switch between the junction of the resistors and the input to pin 3, and can then emulate a touch by closing the switch. Acceptable resistor values (R) are from 100-500 ohms, 1/4 watt or greater.

If a potentiometer is substituted for the two resistors in Part I of Figure A-1, the dummy touchscreen in Part II results. It simulates a touchscreen with touches moving from the upper left to the lower right as the pot is turned. Typical values would be 0-20, 4092-4095 at one extreme and 4092-4095, 0-20 at the other extreme. Potentiometer values (VR) from 100-1000 ohms are acceptable.

A dummy touchscreen which can produce a full range of coordinates (0-4095) in each axis is shown in Part III. This circuit is good for looking at controller problems, as the coordinates in each axis can be varied independently. A joystick can be used for a dummy touchscreen of this type, as long as the pots (VR) are of the appropriate range (100-1000 ohms). Diodes (D) may be 1N4148, 1N4000, etc. If the procedures above indicate a hardware problem, subsequent troubleshooting depends on which controller is being used.

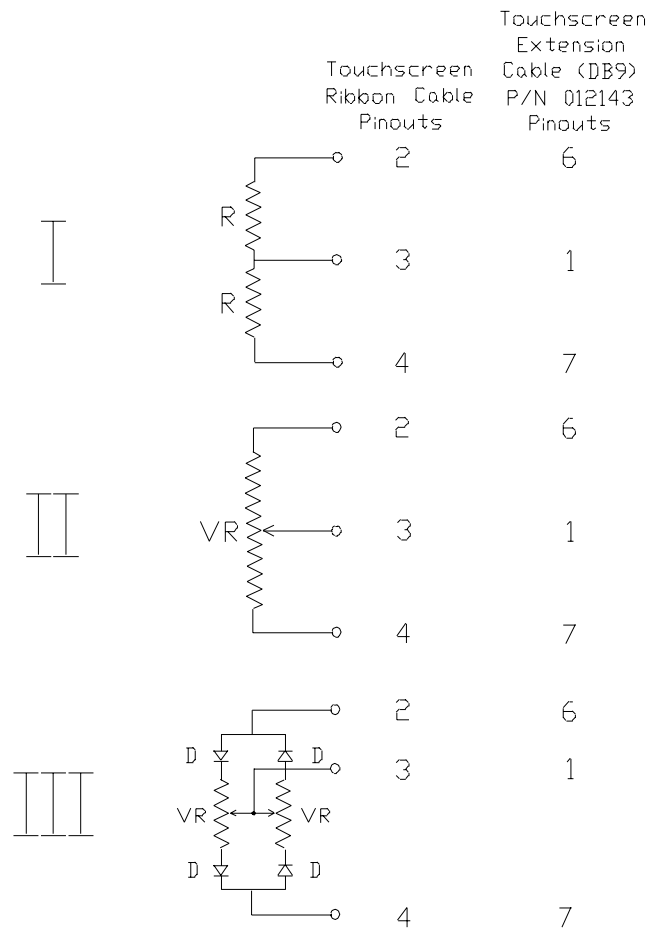

Figure A.1 AccuTouch Touchscreen Simulation Circuits

Serial Controller

The E271-2210 controller is shipped jumpered for 9600 baud, 8 data bits, 1 stop bit, and no parity. See Appendix B for controller jumper settings.

Using the COMDUMP Utility

COMDUMP is a DOS utility included with most Elo driver software. It is also available by downloading the file DIAGS.ZIP at www.elotouch.com/Support/dnld.asp#dos. Use COMDUMP to verify basic controller functionality and to determine whether or not data is reaching the serial port. COMDUMP can be run without a touchscreen driver loaded. Type "COMDUMP <n>" where <n> is the number of the COM port. Detailed instructions can be found at www.elotouch.com/Support/webtech/efcomdump.asp. (If you have the ELODEV driver loaded, also see "Using the TOUCHES Utility" on page A-59.)

If you are not running under DOS, boot your PC from a DOS diskette before running COMDUMP. If you cannot run DOS, use an ASCII terminal or a communications program in local mode to get the same type of analysis provided by COMDUMP. Another option is to temporarily connect the touchscreen to a PC with DOS and run COMDUMP.

If the hardware is functioning properly, untranslated (raw) coordinates will be returned at a constant rate only when the touchscreen is touched. If no data is transmitted on touch, or if data is transmitted when the touchscreen is not touched (either continuously or intermittently), you have a hardware problem.

If the LED is accessible, and it indicates that data is being transmitted, confirm the communication parameters, then try another serial port, possibly on another computer. Also see "RS-232 Connections" on page A-59.

E271-2210 Controller Protocol

The ten-byte binary data format displayed in hex by COMDUMP for correct operation with Elo driver software is as follows:

| Byte | Description |
|------|-----------------------|
| 1 | ASCII 'U' (55h) |
| 2 | ASCII 'T' (54h) |
| 3 | Status Byte |
| 4 | XLow |
| 5 | XHigh |
| 6 | YLow |
| 7 | YHigh |
| 8 | ZLow |
| 9 | ZHigh (defaults to 0) |
| 10 | Checksum |

E281A-4002 Controller Protocol

If the controller is jumpered for E281A-4002 emulation mode, the output will be the six-byte binary format as follows:

| Byte | MSB | | | | | | | LSB | |
|------|-----|---|-----|-----|----|----|----|-----|--|
| 1 | 1 | 1 | X11 | X10 | X9 | X8 | X7 | X6 | |
| 2 | 1 | 0 | X5 | X4 | X3 | X2 | X1 | X0 | |
| 3 | 0 | 1 | Y11 | Y10 | Y9 | Y8 | Y7 | Y6 | |
| 4 | 0 | 0 | Y5 | Y4 | Y3 | Y2 | Y1 | Y0 | |
| 5 | 0 | 0 | 0 | 0 | 0 | 0 | 0 | 0 | |
| 6 | 0 | 0 | 0 | 0 | Z3 | Z2 | Z1 | Z0 | |

In this mode, the first four bytes in each packet will be decreasing, followed by a zero byte, and a byte from 00 to 0F (hex). The Z value (byte 6) will be 00 when you lift your finger.

E271-140 Controller Protocol

If the controller is jumpered for E271-140 emulation mode, the output will be the first four bytes of the E281A-4002 protocol. No Z data is transmitted.

E261-280 Controller Protocol

If the controller is jumpered for E261-280 emulation mode, the output will be three bytes, [01], X, and Y. The [01] byte will change to [81] on release.

Using the TOUCHES Utility

TOUCHES is a DOS utility included on the *TouchTools CD*. It is also included in the DOS and Windows 3.X driver available at www.elotouch.com/Support/dnld.asp#doswindows. TOUCHES works through the ELODEV driver making it useful for further diagnosis of hardware or calibration problems under DOS. Run TOUCHES by typing "TOUCHES". Detailed instructions for using this utility can be found in the *TOUCHES* section of the *DOS and Windows Driver Guide* available at www.elotouch.com/support/dwnldmnl.asp.

Unlike COMDUMP, which displays a stream of bytes in hexadecimal, TOUCHES displays decimal coordinate data. If ELODEV has been calibrated, coordinates will be scaled 80x25. If ELODEV is loaded without the -c calibration flag, and ELOCALIB is not run, raw coordinates will be displayed. Unless you are proficient in hexadecimal, it is easier to check for linearity problems with TOUCHES than with COMDUMP.

Raw coordinates for the E271-2210 serial controller should range from about 400-3800 for X and 600-3500 for Y. When the touchscreen is mounted in its normal orientation, (cable exiting left-center), the origin will be in the lower-left corner. If the touchscreen is installed with the cable exiting right-center, the origin will be in the upper-right corner. Both X and Y should increase steadily as you slide your finger from the origin to the diagonally opposite corner. Check the other two corners to make sure their coordinates look correct and that the touchscreen appears linear in each axis.

TOUCHES should display "TRUE" only when you lift your finger. If "TRUE" releases are indicated while maintaining a constant touch, there may be problems with system timing.

TOUCHES is also useful with PC-Bus controllers to verify the correct IRQ is selected and there are no IRQ conflicts.

RS-232 Connections

Review cable connections and switch settings. If you have used your own cables or adapters for connection to the serial port, check pinouts. Verify that the data transfer rate (baud rate) of the computer's serial port is the same as selected by switches or jumpers on the controller.

The E271-2210 controller operates at standard RS-232 levels. The serial port connector, P2, is a 2x5 male header. Pin positions and signals are given below. See page A-67 for DB9 and DB25 connector pin positions.

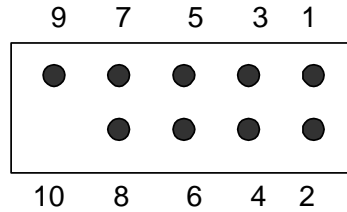

| P2 Pins | DB25 | DB9 | Host Signal | Source |
|---------|------|-----|-------------|------------|
| 1 | 8 | 1 | DCD | Controller |
| 2 | 6 | 6 | DSR | Controller |
| 3 | 3 | 2 | RXD | Controller |
| 4 | 4 | 7 | RTS | Host |
| 5 | 2 | 3 | TXD | Host |
| 6 | 5 | 8 | CTS | Controller |
| 7 | 20 | 4 | DTR | Host |
| 8 | 22 | 9 | RI | N/C |
| 9 | 7 | 5 | GND | Common |
| 10 | | | | Key |

At minimum, a 2-wire connection is required—the controller's serial output (P2 pin 3) and Signal Ground(P2 pin 9). For two-way communications, the controller's serial input (P2 pin 5) should also be connected to the host's Transmit Data pin.

Data Set Ready (DSR) and Clear to Send (CTS) may be used by the host to verify controller connections and operation. DSR is asserted when power is applied to the controller and CTS is asserted when the controller's power-on sequence is complete. For full hardware handshaking, also connect Data Terminal Ready (DTR) and Request to Send (RTS). Elo drivers typically require two-way communication and all four handshaking lines.

If accessible, the controller's diagnostic LED can verify whether RS-232 data is being transmitted.

Alternatively, a breakout box will tell you if there is any activity on the data line. It is possible that the port you are using on the host computer is meant to work with an RS-232 DTE device. To check this, install a null modem cable between the controller and the host computer's serial port. A null modem cable converts a DCE device into a DTE device by swapping pins 2 and 3 and the handshaking lines.

Some serial ports require jumpers for the handshaking lines on the cable connector at the computer end. The jumper combinations that may be required to make an RS-232 port work are beyond the scope of this manual. Consult your computer manual for more information.

If a breakout box is not available, you can measure the DC voltage at the data output of the controller (RXD on the host). It should measure between -8 and -10 Vdc when the touchscreen is not touched, and drop several volts (towards 0) during a touch, depending on the data format and the baud rate. Slower baud rates and ASCII data format will produce larger shifts in DC levels during the transmission of touch data.

If proper RS-232 signal voltage is not present, the controller may not have power applied.

Power Supply

Check for proper voltage (+5 Vdc) at the power connector P4 on the controller. If the LED is functioning, the power supply is probably okay. To access this connector on the Tabletop Serial Controller, disconnect the power cable then remove the screws from the bottom of the cover. After the cover has been removed, reconnect the power cable and turn the unit on. There are no exposed electrical connections in the controller that would be considered dangerous. Power is applied to the controller through P4.

If no power is present, measure the voltage at the power supply. If using the Tabletop Controller power supply, the pinout (5-pin DIN male), is shown in Figure A-2. Only +5 Vdc and Ground are used by the E271-2210 controller.

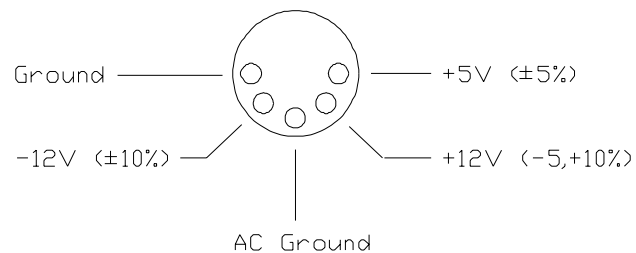

Figure A.2 Tabletop Controller Power Supply Cable Connector

Bus Controller

The 2201 controller is shipped jumpered for a Base I/O Port address of 280 (hex) and Polled Mode. An interrupt (IRQ) is normally selected by software if you are using Elo device drivers. No jumper changes are required, with the possible exception of an E271-2201 controller reconfigured for E271-141 emulation. See Appendix B for jumper settings.

If the system does not boot properly after you install the E271-2201 controller, try removing the IRQ jumper if one was installed. If the system still does not boot, try changing the Base I/O Port address jumpers to another value, such as 380 hex.

If accessible, the controller's diagnostic LED's can verify controller operation. See "Diagnostic Codes" on page A-66.

Using the BUSSTAT Utility

BUSSTAT is a DOS utility included with most Elo driver software. It is also available by downloading the file DIAGS.ZIP at www.elotouch.com/Support/dnld.asp#dos. Use BUSSTAT to verify basic hardware functionality. Detailed instructions for using this utility can be found in the *BUSSTAT* section of the *DOS and Windows Driver Guide* available at www.elotouch.com/support/dwnldmnl.asp. If you are not running under DOS, boot your PC from a DOS diskette before running BUSSTAT.

BUSSTAT is a Polled Mode program and can be run even if no touchscreen driver is loaded and the IRQ is incorrect or not selected. Verify the Base I/O Port address jumpers before using BUSSTAT.

Type "BUSSTAT" and specify your controller model and Base I/O Port address. BUSSTAT displays the switch and jumper settings for the controller and then unscaled touch coordinates when the touchscreen is touched. Compare the displayed settings to those recommended in the software driver manual. If the Base I/O Port address is incorrect, BUSSTAT may display a continuous stream of data at a value of 4080 for both the X and Y values.

If the hardware is functioning properly, untranslated (raw) coordinates will be returned at a constant rate only when the touchscreen is touched. If no data is displayed on touch, or if data is displayed when the touchscreen is not touched (either continuously or intermittently), you may have a hardware problem. If data is being displayed continuously without a touch, try disconnecting the touchscreen cable from the controller. If the data stops, the problem is with the touchscreen or cable. If it continues, the problem is controller-related.

Verify that the controller board is properly seated in its slot. Try installing the controller in another slot. If another controller is available, try it as well. Also try another computer.

Look at the coordinates output by BUSSTAT. The coordinates should range from about 400-3800 for X and from 600-3500 for Y. When the touchscreen is mounted in its normal orientation, (cable exiting left-center), the origin will be in the lower-left corner. If the touchscreen is installed with the cable exiting right-center, the origin will be in the upper-right corner. Both X and Y should increase steadily as you slide your finger from the origin to the diagonally opposite corner. Check the other two corners to make sure their coordinates look correct and that the touchscreen appears linear in each axis. If the coordinates appear to be meaningless, try changing the Base I/O Port address of the controller. Another device may be contending for the same I/O address.

If BUSSTAT works properly, try the TOUCHES diagnostic utility, described on page 59. If TOUCHES does not display any data, the problem is probably that the IRQ is incorrectly specified on the driver command line or there is an IRQ conflict with another device. See *Choosing an Interrupt for PC-Bus Controllers* in the *DOS and Windows Driver Guide* available at www.elotouch.com/support/dwnldmnl.asp.

Touchscreen Cables

Pinouts from the touchscreen to a PC-Bus or serial controller are as follows:

| Signal | Touchscreen Ribbon Cable | Transient Protection Cable (DB9) P/N 899389-000 | Touchscreen Cable (DB9) P/N 454173-000 |
|--------|--------------------------|---|--|
| H | 1 | 9 | 9 |
| X | 2 | 6 | 6 |
| S | 3 | 1 | 1 |
| Y | 4 | 7 | 7 |
| L | 5 | 8 | 8 |

See “DB9 and DB25 Connector Pin Positions” on page A-67 for DB9 connector pin positions.

P/N 454173-000 Cable

This cable may connect:

- a touchmonitor to a PC-Bus controller
- a touchmonitor with an internal serial controller to the computer’s serial (COM) port.

It is a straight-through cable, and all nine pins are used. Check this cable with an ohmmeter. Other common computer data cables may be substituted for this cable.

Transient Protection Components

The transient suppression diodes behave like ordinary diodes when checked with most ohmmeters. These components normally fail by shorting. See the following figure for a circuit diagram:

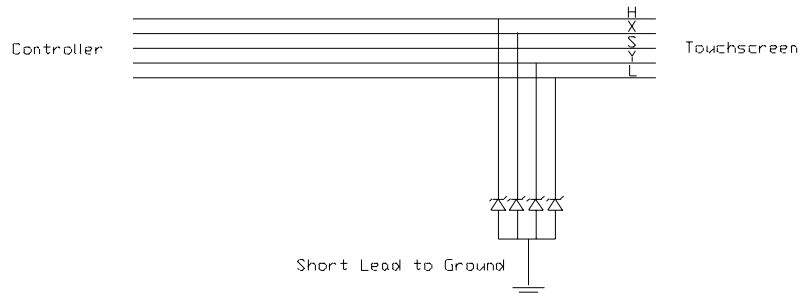

Figure A.3 Transient Protection Circuit

Diagnostic LEDs

Depending on where the controller is installed, the LEDs may or may not be visible.

2210 Serial Controller

The E271-2210 serial controller has one yellow diagnostic LED. Following power on, the controller performs its self-test. (ELODEV displays the result of this test when the loaded.) After the self-test, the LED flashes about 1.5 times a second, indicating normal operation.

During normal operation, the LED also indicates controller/host communication is in progress. For example, when the touchscreen is touched, the LED should be on or flicker, then return to the normal blink rate when the touch is removed. If the host does not remove the packet from the controller, the LED will stay on.

If the LED stays on without a touch, the touchscreen or cabling may be shorted. Disconnect the touchscreen cable from the controller and cycle power to the controller. If the problem persists, a fault in the power supply is likely.

If the LED flashes about four times a second, a warning error condition is indicated, such as improper communication from the host. The baud rate or other communication parameters may be suspect.

3000U USB Controller

The 3000U controller has two LED status indicators.

A green LED (D1) indicates controller status as follows:

| LED Blink Rate | Function |
|------------------|-----------------------------------|
| Once per second | Normal condition, untouched state |
| On continuously | Touched state |
| Twice per second | Error detected |

A second LED (D6) indicates USB status as follows:

| LED State | Function |
|-----------|--|
| OFF | Controller is not enumerated on USB |
| ON | Controller is enumerated on USB, but there is no data transfer |
| Blinking | USB data transfers between controller and host are occurring |

2201 PC-Bus Controller

The E271-2201 PC-Bus controller has three diagnostic LED's. Following power on, the controller performs its self-test. After the self-test, a flashing green LED indicates normal operation. If a fatal error was encountered, the yellow and red LED's flash an eight-bit error code starting with the most significant bit, where yellow indicates a binary '0' and red a binary '1'. See the *SmartSet Touchscreen Controller Family Technical Reference Manual* available at www.elotouch.com/support/dwnldmnl.s.asp, or contact Elo Technical Support for a list of error codes.

During normal operation, the yellow LED indicates controller/host communication is in progress. For example, when the touchscreen is touched, the yellow LED should light or flicker (may not be visible with bus controllers on fast PC's). If the host does not remove the packet from the controller, the LED will stay lit.

If the yellow LED lights without a touch, the touchscreen or cabling may be shorted. Disconnect the touchscreen cable from the controller and cycle power to the controller to verify this condition.

A constant red LED indicates a warning error condition, such as improper communication from the host. Suspect the baud rate or other communication parameters.

Diagnostic Codes

AccuTouch controller power-on diagnostic codes are typically displayed when an Elo driver is loaded, or through the Touchscreen Control Panel. The codes will be a pair of bytes displayed in hex. Only the first byte is significant with AccuTouch controllers.

The following table lists the bit positions defined for the byte. A 1 bit indicates a failure. Diagnostic codes are computed by summing the value for each bit position using hexadecimal arithmetic.

| Bit | Value (hex) | Description |
|-----|-------------|--|
| 7 | 80 | Touch microprocessor test incomplete |
| 6 | 40 | Reserved |
| 5 | 20 | Touch microprocessor test failed— touchscreen may not be connected |
| 4 | 10 | Nonvolatile RAM checksum test failure |
| 3 | 08 | RAM read/write test failure |
| 2 | 04 | ROM checksum test failure |
| 1 | 02 | Microprocessor logic/register test failure |
| 0 | 01 | Firmware/hardware compatibility test failure |

DB9 and DB25 Connector Pin Positions

The following figure is useful when locating pin positions on DB9 and DB25 connectors.

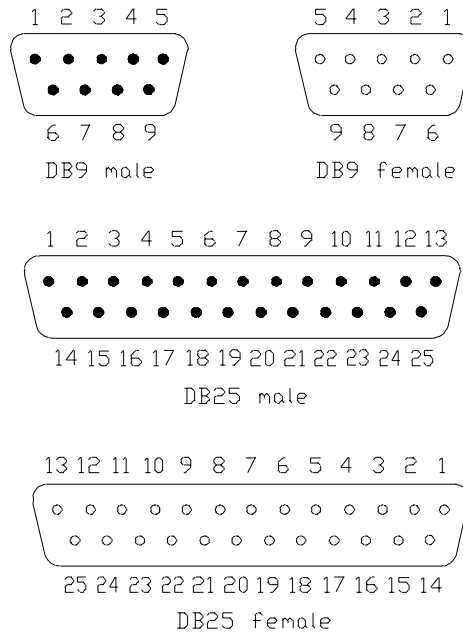

Figure A.4 DB9 and DB25 Connector Pin Positions

B

CONTROLLER CONFIGURATION

General Information

AccuTouch controllers are shipped pre configured for use with Elo driver software. For most users, no changes are necessary. Specific jumper settings and options available for your controller are listed in the Elo software manuals and in this appendix.

The following sections are for quick reference only. See the *SmartSet Touchscreen Controller Family Technical Reference Manual* available at www.elotouch.com/support/dwnldmnl.asp for a complete description of all jumper settings for the 2210 and 2201 controllers. See www.elotouch.com/products/accutec/c3000u.asp for a complete description of the 3000U controller. Factory default settings compatible with Elo driver software are indicated by an asterisk (*).

Jumper Settings

The following applies to 2210 and 2201 controllers only. Jumper blocks may have a horizontal or vertical orientation, as shown in Figure B.1 on page B-70. The figure shows jumpers installed normally for J3 and J7. Because some jumpers work in tandem with others, a *cross-connection* may also be significant. A valid cross-connection is shown between J0 and J1. Jumpers with an invalid cross-connection, as with J4 and J5, have no effect and are available as extra jumpers. To enable use of the jumpers, J7 must be installed. If J7 is not installed, power-on settings are from NVRAM.

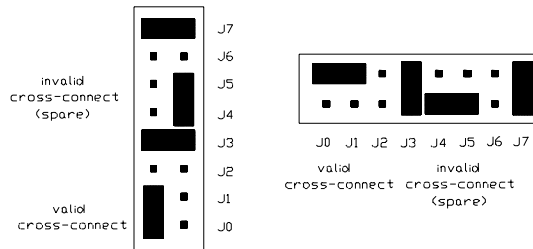

Figure B.1 SmartSet Controller Jumper Settings

2210 Serial Controller

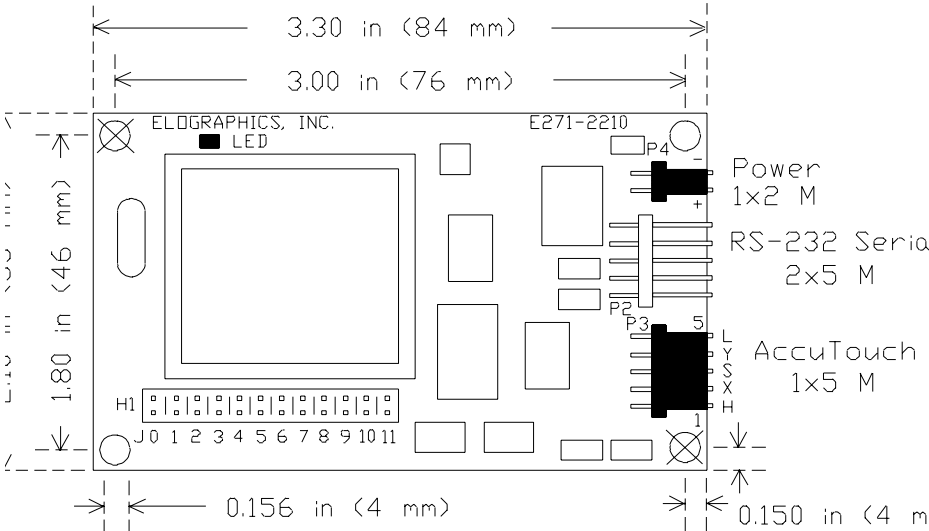

Figure B.2 E271-2210 Serial Controller

Jumper Settings

| Baud Rate | (From Left) |
|-----------------------------|---|
| 9600 | J0 - N* J1 - N* |
| 2400 | J0 - Y J1 - N |
| 1200 | J0 - N J1 - Y |
| 300 | J0 - Y J1 - Y |
| 19200 | Cross-connect (connect jumper horizontally so the top pins of J0 and J1 are jumpered) |
| Output Format | |
| Binary | J2 - N* |
| ASCII | J2 - Y |
| Hardware Handshaking | |
| Enabled | J3 - N* |
| Disabled | J3 - Y (may be needed in emulation mode) |
| Mode | |
| Stream | J4 - N* |
| Single-Point | J4 - Y |
| Reserved | J5 - N* |
| Reserved | J6 - N* |
| Power-On Settings | |
| Jumpers | J7 - Y* |
| NVRAM | J7 - N |
| Reserved | J8 - N* |
| Reserved | J9 - N* |
| Emulation Mode | |
| None | J10 - N* J11 - N* |
| E271-140 | J10 - Y J11 - N |
| E261-280 | J10 - Y J11 - Y |
| E281A-4002 | J10 - N J11 - Y |

* indicates factory default settings, compatible with Elo driver software

2210 Emulation Modes

If you are using driver software that does not support the E271-2210 protocol, the controller can be set up through jumpers J10 and J11 for hardware compatibility with the IntelliTouch® E281A-4002, the AccuTouch E271-140, or the DuraTouch® E261-280 controller.

3000U USB Controller

The 3000U controller comes preconfigured for use with Elo drivers and does not require changes to any jumpers. For detailed information on the 3000U controller go to www.elotouch.com/products/accutec/c3000u.asp.

2201PC-Bus Controller

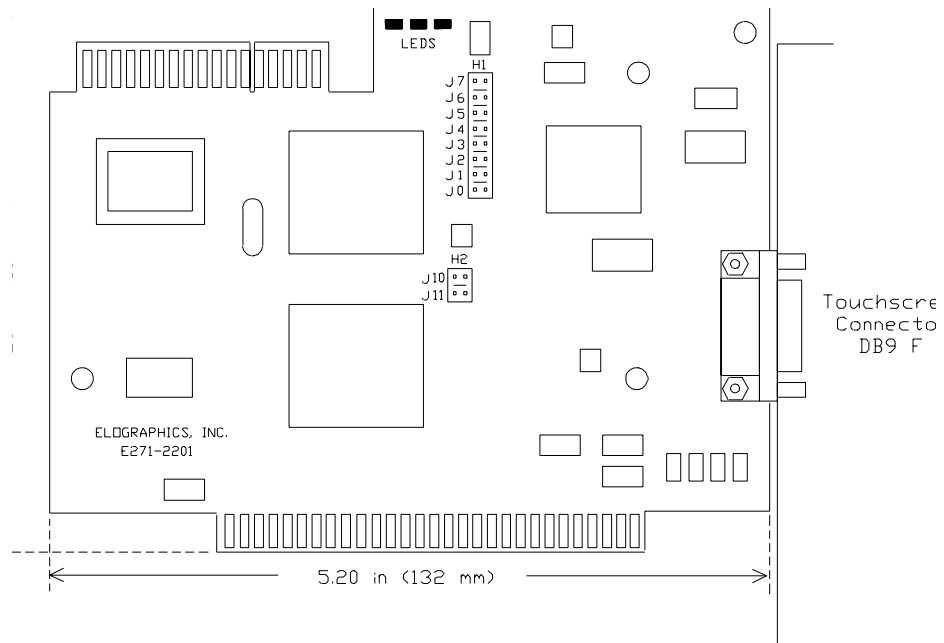

Figure B.3 E271-2201 PC-Bus Controller

Jumper Settings

| | (From Top) |
|-----------------------------|---|
| Default from jumpers | J7 - Y* |
| Reserved | J6 - N* |
| Touchscreen Type | |
| AccuTouch (3 or 5 wire) | J5 - Y* |
| DuraTouch | J5 - N |
| Mode | |
| Stream | J4 - N* |
| Point | J4 - Y |
| Interrupt | |
| None (Polled) | J3 - N* |
| | J2 - N* |
| IRQ2 | J3 - Y |
| | J2 - Y |
| IRQ3 | J3 - Y |
| | J2 - N |
| IRQ5 | J3 - N |
| | J2 - Y |
| IRQ7 | Cross-connect (connect jumper vertically so the left pins of J2 and J3 are jumpered.) |
| (From Top) | |
| Base Port (in hex) | |
| 280 (recommended) | J1 - N* |
| | J0 - N* |
| 240 | J1 - N |
| | J0 - Y |
| 180 | J1 - Y |
| | J1 - N |
| 100 | J1 - Y |
| | J0 - Y |
| 2A0 | Cross-connect (connect jumper vertically so the left pins of J0 and J1 are jumpered) |

(From Top)

Emulation Mode

| | |
|------------|----------|
| None | J10 - N* |
| | J11 - N* |
| E271-141 | J10 - Y |
| Resolution | |
| 8-Bit | J11 - Y |
| 12-Bit | J11 - N |

* indicates factory default settings, compatible with Elo driver software

2201 Emulation Modes

If you are using driver software that does not support the E271-2201 protocol, the controller can be set up through jumpers J10 and J11 for hardware compatibility with the AccuTouch E271-141 controller (or the DuraTouch E271-142 controller).

APPENDIX

C

SPECIFICATIONS

The following specifications were correct at press time, but are subject to change without notice.

Many of the AccuTouch specifications are controller-dependent. Refer to the *AccuTouch Touchscreen Products* brochure or the *SmartSet Touchscreen Controller Family Technical Reference Manual* for these additional specifications.

AccuTouch products are covered by one or more of the following patents:
4,071,689; 5,220,136; 4,220,815; 4,661,655; 4,687,885; 4,731,508; 4,822,957;
5,045,644.

Mechanical

| | |
|--|--|
| Construction | <p>Top: Polyester with outside hard-surface coating with clear or antiglare finish.</p> <p>Inside: Transparent conductive coating.</p> <p>Bottom: Glass substrate with uniform conductive coating.</p> <p>Top and bottom layers separated by Elo's patented separator dots.</p> |
| Dimensions | <p>The following physical dimensions of the touchscreen are specified for each model in the <i>AccuTouch Touchscreen Products</i> brochure or the appropriate Elo Specification Control Drawing:</p> <p>Horizontal and Vertical physical size.</p> <p>Horizontal and Vertical border region size.</p> <p>Horizontal and Vertical touch active area size.</p> <p>Radius of curvature (ROC) information.</p> <p>Cable exit location, length, and connector type.</p> |
| Cable and Connector | <p>Typically a ribbon/flex cable exiting from side, with five-position 0.025-inch (0.635 mm) square post receptacle (AMP 86015-1) termination standard AMP 87499-9 housing with 0.100-inch (2.54 mm) centers. The cable length and connector are specified on drawings available from Elo for each touchscreen.</p> |
| Positional Accuracy | <p>Standard deviation of error is less than ± 0.080-inch (2 mm).</p> |
| Resolution | <p>More than 100,000 touchpoints/in² (15,500 touchpoints/cm²) for a 13-inch touchscreen when used with Elo controllers.</p> |
| Touch Activation Force | <p>Typically 2 to 4 ounces (57 to 113 g).</p> |
| Surface Durability | <p>Surface meets Taber Abrasion Test (ASTM D 1044), CS-10F wheel, 500 g.</p> |
| E274HL and E274A Enhanced Antiglare Products | <p>Additionally, pencil hardness is typically 2H to 3H (ASTM D 3363).</p> |
| Expected Life Performance | <p>The AccuTouch technology has been operationally tested to more than 35 million touches in one location without failure using a stylus similar to a finger.</p> |
| Sealing | <p>Unit can be sealed to NEMA requirements. Gasket or sealant can make contact to inactive border region of touchscreen.</p> |

Optical

Light Transmission

| | |
|--|--|
| Standard and E274A Enhanced Antiglare Products | <p>From 55% to 57% over the visible light spectrum, per ASTM D 1003. Provides neutral density filtering and contrast enhancement on CRT's and other active displays.</p> |
| E274HL Products | <p>Typically 75% over visible light spectrum, per ASTM D 1003. Optimized for flat panel displays.</p> |

Visual Resolution

| | |
|--|---|
| Standard Products | Clear surface: 7:3 minimum. Antiglare surface: 2:1 minimum. |
| E274HL and E274A Enhanced Antiglare Products | Clear surface: N/A. Antiglare surface: 6:1 minimum. All measurements made using USAF 1951 Resolution Chart, under 30X magnification with test unit located approximately 1.5-inches (38 mm) from surface of resolution chart. |
| Haze | Clear surface: Less than 1.5%. Antiglare surface: Less than 15%. Per ASTM D 1003. |
| Gloss | Clear surface: N/A. Antiglare surface: 90 ± 20 gloss units tested on a hard-coated front surface. Per ASTM D 2457. |
| Electrical | All touchscreen drive signals are developed by the interfacing controller. Refer to the <i>SmartSet Touchscreen Controller Family Technical Reference Manual</i> for these specifications or to the <i>AccuTouch Touchscreen Products</i> brochure for these specifications. |
| Drive Current | Typically less than 250 mA at +5 Vdc for a standard 13-inch touchscreen. |
| Signal Current | The maximum cover sheet current is 300 µA. |
| Capacitance | 200 to 350 pF/in ² (31 to 54 pF/cm ²). |
| Open Circuit Resistance | Greater than 2 MΩ. |
| Closed Circuit Resistance | Less than 1 kΩ. |

Environmental

| | |
|---------------------|---|
| Temperature | Operating: -10°C to 50°C. Storage: -40°C to 71°C. |
| Relative Humidity | Based on 24-hour period, non-condensing. Operating: 90% RH at 35°C. Storage: 90% RH at 35°C. |
| Chemical Resistance | The touch active area of the touchscreen is resistant to the following chemicals when exposed for a period of one hour at a temperature of 70°F (21°C): Acetone Ammonia-based glass cleaners Common foods and beverages Hexane Isopropyl alcohol Methylene chloride Methyl ethyl ketone Mineral spirits Turpentine |

Electrostatic Protection When tested per IEC 801-2 (150 pF and 150 Ω), the touchscreen shall withstand 20 discharges of 15 kV, distributed randomly across the active area of the touchscreen with proper transient protection.

Fire Retardation Meets the requirements of UL-746C, 3/4-inch (19-mm) flame test.

Agency Approvals

UL Compliance AccuTouch touchscreens and controllers are UL-Recognized Components. UL file no. E133802. Complies with standards of ball impact test of UL 1950.

FCC Compliance Systems incorporating Elo touchscreens, controllers and cables have been verified to FCC Class A compliance.

TÜV Rheinland Bauart Compliance AccuTouch touchscreens and controllers meet EN 60950/08.92, EN 60950A1/01.93, and EN 60950A2/08.93. Certificate numbers 9577139 and 9577140.

APPENDIX

D

ELO PART NUMBERS

| Description | Part Number |
|---|-------------|
| AccuTouch® Accessories | |
| Touchscreen installation kit - Includes double-sided tape, velcro, cable ties, and screw hardware commonly used in touchscreen installation (spherical and cylindrical). | 458095-000 |
| Internal mounting kit for serial controller - Includes mounting hardware to install an internal serial controller. | 734849-000 |
| Power Supplies and Wiring Harnesses | |
| Power supply, 100-240 Vac, 47-63 Hz in, +5 Vdc output. For tapping off monitor AC power for internal AccuTouch and IntelliTouch controllers | 742067-000 |
| Power supply, wall mount, 120 Vac to +5 Vdc (US). Power to serial Accutouch or IntelliTouch controllers. | 580979-000 |
| Power Supply, wall mount, 230 Vac to +5 Vdc (Intl). Provides power to serial controller (International). | 319865-000 |
| 48 in. wiring harness, 1X2F with twisted pair. Serial controller input power wiring harness for AccuTouch. | 928367-000 |
| Transient Suppression | |
| 6 in. ribbon cable, 5 pin male to DB9M with tranzorbs and screw kit. Provides transient protection. Goes from touchscreen to back of display. (spherical and cylindrical) | 899389-000 |
| Transient protection cable for serial controller. Provides transient protection. Goes from touchscreen to E271-2210MX. Simplifies monitor integration. | 484815-000 |
| 10" in. ribbon cable, 5 pin male to DB9M with tranzorbs and screw kit. Provides transient protection. Goes from touchscreen to back of display. (spherical and cylindrical) | 596595-000 |

| Description | Part Number |
|---|--------------------|
| Cables | |
| USB connector cable, 18 inch length, to connect monitor to host computer | 793054-000 |
| USB connector cable, 72 inch length, to connect monitor to host computer | 775252-000 |
| 72 in. DB9M to DB9F. Touchscreen cable or serial output cable. Goes from back of display to controller or serial port. | 454173-000 |
| Standard DIN keyboard power tap cable. Serial controller keyboard power tap cable. | 980773-000 |
| PS/2 Mini DIN keyboard power tap cable. Serial Controller keyboard power tap cable. | 388923-000 |
| 72 in. DB25M to DB9F. Serial controller output cable. | 782411-000 |
| 30 in. 2x5F to DB9M with tranzorbs and screw kit. Provides transient protection. Goes from AccuTouch or IntelliTouch touchscreen to display back. | 942741-000 |
| 17 in. ground with ring terminals. Connect IntelliTouch or AccuTouch serial controller or DB9 shell at back of display to chassis ground. | 459635-000 |
| DB9M to 8-pin mini-DIN male for Macintosh. Serial cable for touchmonitors with internal serial controllers to interface with Macintosh. | 084037-000 |
| International Power Cable - Europe. For use with 004100-205 (and monitors) in Europe (generally). | 323227-000 |
| International Power Cable - United Kingdom. For use with 004100-205 (and monitors) in the U.K. | 276875-000 |
| Adapters | |
| 2 in. DB9M to DB25F. Converts a DB9F to DB25F for use with DB25 serial port. | 539325-000 |
| Stylus | |
| AccuTouch Stylus | 442187-000 |
| AccuTouch[®] Controller Kits and Components | |
| Controller and Cable Kits | |
| PC-Bus AccuTouch Controller Card, half slot | 981411-000 |
| 72 in. DB9M to DB9F. Touchscreen cable or serial interface output cable. Goes from back of display to controller or serial interface port. | 454173-000 |
| E271-2210 Serial interface RS-232 internal AccuTouch Controller Card | 055165-000 |
| 3000U USB Controller for resistive touchscreen | 608244-000 |
| Internal mounting kit for serial AccuTouch interface controller - Includes mounting hardware to install an internal Serial interface controller. | 734849-000 |
| USB Cable Pack for resistive (18" USB cable, 72" USB cable, & panel mount adaptor) | 310900-000 |
| E271-2210MX Serial RS-232 Controller Card, external | 462337-000 |
| Optional Cable Kit Configurations | |
| 2210MX Accutouch Kit - Keyboard Power Tap, Standard | 877989-000 |
| 2210MX AccuTouch Kit - Keyboard Power Tap, PS/2 | 073089-000 |
| 2210MX AccuTouch Kit - Wall Mount Power Supply | 370187-000 |

| Description | Part Number |
|--|-------------|
| 2210MX AccuTouch Kit - Internal Wall Mount Power Supply | 460987-000 |
| 2210MX AccuTouch Kit - Internal Monitor Supply | 520467-000 |
| AccuTouch Controller Chip (COACh) | 115275-000 |
| AccuTouch COACh Starter Kit - 313931 Controller Chip, 2210 Serial interface Controller Card, cable, 2741HL-683 10.4" touchscreen, COACh Application Manual | 946665-000 |
| AccuTouch® Spherical Touchscreens | |
| AccuTouch 10" spherical, antiglare touchscreen | 546331-000 |
| AccuTouch 14" spherical, antiglare touchscreen | 286577-000 |
| AccuTouch 14" spherical, antiglare touchscreen | 028731-000 |
| AccuTouch 14" spherical, antiglare touchscreen | 200163-000 |
| AccuTouch 15" spherical, antiglare touchscreen | 898797-000 |
| AccuTouch 15" spherical, antiglare touchscreen | 394547-000 |
| AccuTouch 15" spherical, antiglare touchscreen | 651571-000 |
| AccuTouch 15" spherical, antiglare touchscreen | 047445-000 |
| AccuTouch 15" spherical, antiglare touchscreen | 143917-000 |
| AccuTouch 15" spherical, antiglare touchscreen | 543347-000 |
| AccuTouch 15" spherical, antiglare touchscreen | 284529-000 |
| AccuTouch 15" spherical, antiglare touchscreen | 677489-000 |
| AccuTouch 15" spherical, antiglare touchscreen | 184825-000 |
| AccuTouch 15" spherical, antiglare touchscreen | 294825-000 |
| AccuTouch 17" spherical, antiglare touchscreen | 317383-000 |
| AccuTouch 17" spherical, antiglare touchscreen | 984791-000 |
| AccuTouch 17" spherical, antiglare touchscreen | 943813-000 |
| AccuTouch 17" spherical, antiglare touchscreen | 496651-000 |
| AccuTouch 17" spherical, antiglare touchscreen | 130671-000 |
| AccuTouch 17" spherical, antiglare touchscreen | 325653-000 |
| AccuTouch 19" spherical, antiglare touchscreen | 721895-000 |
| AccuTouch 19" spherical, antiglare touchscreen | 880555-000 |
| AccuTouch 21" spherical, antiglare touchscreen | 969153-000 |
| AccuTouch 21" spherical, antiglare touchscreen | 001645-000 |
| AccuTouch 6.4" flat, antiglare touchscreen | 407349-000 |
| AccuTouch 7.1" flat, antiglare touchscreen | 821949-000 |
| AccuTouch 7.7" flat, antiglare touchscreen | 211257-000 |
| AccuTouch 8.4" flat, antiglare touchscreen | 223289-000 |
| AccuTouch 9.4" flat, antiglare touchscreen | 661969-000 |
| AccuTouch 9.8" flat, antiglare touchscreen | 926415-000 |
| AccuTouch 10.4" flat, antiglare touchscreen | 526535-000 |
| AccuTouch 11.3" flat, antiglare touchscreen | 911599-000 |

| Description | Part Number |
|---|-------------|
| AccuTouch 12.1" flat, antiglare touchscreen | 387507-000 |
| AccuTouch 13.2" flat, antiglare touchscreen | 848331-000 |
| AccuTouch 13.3" flat, antiglare touchscreen | 746010-000 |
| AccuTouch 13.6" flat, antiglare touchscreen | 023177-000 |
| AccuTouch 13.8" flat, antiglare touchscreen | 648865-000 |
| AccuTouch 14.0" flat, antiglare touchscreen | 146497-000 |
| AccuTouch 14.2" flat, antiglare touchscreen | 385171-000 |
| AccuTouch 15.0" flat, antiglare touchscreen | 856093-000 |
| AccuTouch 15.1" flat, antiglare touchscreen | 635661-000 |
| AccuTouch 16.0" flat, antiglare touchscreen | 284363-000 |
| AccuTouch 16.8" flat, antiglare touchscreen | 799357-000 |
| AccuTouch 17.1" flat, antiglare touchscreen | 971949-000 |
| AccuTouch 17.7" flat, antiglare touchscreen | 531381-000 |
| AccuTouch 18.1" flat, antiglare touchscreen | 767223-000 |
| AccuTouch 20.4" flat, antiglare touchscreen | 937333-000 |

GLOSSARY

A

Autosizing-True autosizing occurs when a monitor can maintain a constant image size across different video modes. Two common ways of achieving autosizing are mode sensing, pre-programmed factory settings and user defined modes.

B

Bandwidth-The range of frequencies over which the video display's electronics can respond. This is directly related to the speed at which the monitor can accept pixel information and to the maximum resolution the monitor can display.

Barrel-A type of distortion in which an images's sides or top (or both) appear to bulge outward.

Blooming-When image brightness increases, the CRT's electron beam tends to spread out and lose focus. This loss of focus on bright portions of an image makes the image appear to expand or "bloom", and lose detail.

Bow-A type of distortion in which opposite sides of the screen image curve in the same direction.

C

Convergence-The ability of the monitor to correctly align the red, green and blue components of an image on the screen. Convergence problems are often visible as fringes of color at the edge of the screen or color around text or graphics where it should be white.

CRT-An acronym for cathode ray tube. A type of display in which images are created by electron beams that caused the glowing of phosphors inside the surface of a glass screen.

D

DAF-Dynamic Astigmatism Focus. A technique using a quadruple lens to focus the electron beams horizontally and diffuse it vertically.

Dot Pitch-The distance between a phosphor dot and the next nearest dot of the same color on a CRT, expressed in millimeters. The dot pitch does not correspond to the display resolution in pixels. Instead, the CRT's electron beam hits one or more phosphor dots to create a pixel. Monitors with smaller dot pitches generally produce sharper images because smaller phosphor dots can be used to represent each pixel more accurately.

DPMS™-Display Power Management Signaling standard. VESA® standard which ensures that monitor and video manufacturers produce power saving products that work together.

DQ-DAF-Double-Quadruple Dynamic Astigmatism and Focus. The basic technology of the DQ-DAF is the same as the DAF. The DQ-DAF has two sets of quadruple lenses in addition to the main focus lens. This provides separate horizontal and vertical focusing, and thus greater focal compensation than the standard DAF. This greater focal control gives a finer image and minimal Moire.

Drift-See swim.

E

Electron Gun-Located at the narrow end of the CRT, the electron gun shoots electron beams at colored phosphor dots to form the image on a monitor.

F

Flicker- Unsteadiness of the image caused by low refresh rate.

Frequency-Defines the number of events during a time period. Hertz (Hz) is a measurement of frequency.

G

Graphics Mode-A scanning mode in which greater number of dots, that form an image, are displayed with various colors and patterns.

H

Hertz-(Hz)-A unit used to measure frequency. It is defined as numbers of events per second. 1 Hz=1 cycle per second.

Horizontal Scanning-The movement an electron beam traces across horizontal phosphor dots on the CRT.

Horizontal Scanning Frequency-The rate in kHz of how many times an electron beam traces across horizontal lines of phosphor dots in one second, “painting” the image. Monitors with higher horizontal rates can run higher resolutions.

I

Interlaced Scanning Mode-A scheme that takes two passes to paint an on screen image, painting every other line on the first pass and sequentially filling in the rest of the line on the second pass. This scheme usually causes flicker.

Interlacing-See Interlaced Scanning Mode.

Invar-Shadow Mask-A special type of shadow mask that is made out of Invar, an alloy that is able to withstand high temperature generated by the electron beam. The Invar shadow mask allows the CRT to generate a brighter image than the conventional shadow mask. (See Shadow Mask). An Advanced Invader Shadow Mask improves brightness by 40% over the standard.

J

Jitter-See Swim.

K

k-Small letter k stands for Kilo, Greek for 1,000, e.g. kg, kHz.

Keystone-A type of distortion in which the screen image is smaller at one side of the screen than at the opposite side.

L

LCD-Liquid Crystal Display (LCD) monitors form screen images using liquid crystals activated by electronic fields. LCD monitors are flat and thin, producing smooth, crisp images with less distortion. Commonly used in notebook computers.

Linearity-The tendency for changes in an image to be constant. Non-linearity causes images to be more distorted in one area of the screen than in another. This is sometimes caused by poor voltage regulation in the monitor's electronics.

Low Emission-A characteristic of a monitor that has special shielding to lower the emission of ELF (extremely low frequency) and VLF (very low frequency). It is usually referred to as a government safety standard, e.g. MPRII.

Low Radiation-See Low Emission.

M

M-Upper case M stands for Mega, Greek for 1 million, e.g. MHz.

Microprocessor Based Monitor-This type of monitor normally has more flexibility in accepting input signals and more adjustment functions. It also contains internal memory to save screen image information (size, position, signal timings, etc.).

Misconvergence-The inability of the monitor to correctly align the red, green and blue components of an image on the screen (see primary color). Misconvergence is often visible as fringes of color at the edge of the screen or color around text or graphics where it should be white.

Moiré-A wavy distortion pattern caused by the interference between contrast, brightness and other characteristics of the input signal.

MPR-II-The radiation emission standard published by the Swedish National Board for Measurement and testing.

Multi-Frequency vs Fixed Frequency-Fixed frequency monitors can only sync on one horizontal scan rate (e.g. 31.5 kHz). Most of this type of monitors are VGA only. There are two basic types of multi-frequency monitors: the tri or quad sync multi-frequency monitor, and the variable multi-frequency monitor. Tri/quad sync monitors will sync on 3 to 4 different horizontal scan rates (e.g. 31.5 kHz, 35.2 kHz, 48 kHz). Higher resolution/refresh rates can be achieved from this higher horizontal scanning capability. A variable multi-frequency monitor will have a range of horizontal scan rates (e.g. 31 kHz to 64 kHz) and vertical scan rates (e.g. 50Hz to 90Hz). The monitor will sync on any input signal which falls into these ranges. Most variable mullet-frequency monitors are microprocessor based.

Multiple Frequency Monitor-A monitor that can be set at more than one video mode. A true multiple frequency monitor can be set at all the video modes that are currently in use today, e.g. CGA,EGA, VGA, SVGA, etc.

Multiple Scanning Monitor-See Multiple Frequency Monitor.

N

Non-glare-a term used to describe the specially treated monitor surface as non-reflective.

Non-interlaced Scanning Mode-A scheme for painting an on-screen image that paints all the lines in one pass and then paints an entirely new frame. A non-interlaced scanning mode reduces flicker.

Non-static-a term describing the characteristics of a specially treated monitor that prevents build-up of static electricity on the monitor surface.

P

Persistence-A measurement of screen phosphor substance. It indicates how long the phosphors continue to glow after being struck by the picture tube's electron beams.

Phosphor Dots-Colored compounds that coat the inside of the CRT screen in tiny dots. When struck by electron beams from the electron gun, the phosphor dots glow to create the image on the monitor.

Pincushion-A type of distortion in which the sides or top of the screen image seems to curve inward.

Pixel-The smallest information building block of an on-screen image. The resolution of a monitor is determined by the number of pixels covering the width and height of the complete on-screen image.

Primary Colors-In light (and in monitors, which produce light) they are the basic colors-red, green and blue-that can be added together to create any other color.

R

Raster Area-The area of the CRT which has the ability to display a video image.

Refresh-The process in which the monitor repaints an image.

Refresh Rate-The rate at which a monitor repaints an image. A refresh rate of 60 Hertz, for example, means the screen is drawn 60 times per second. A low vertical refresh rate produces visible flicker.

Resolution-A standard by which the sharpness of the monitor is defined. It is defined by the number of pixels that are used to form an image. For example, a resolution of 1024 by 768 has 1024 pixels running horizontally and 768 pixels running vertically for a total of 786,432 pixels.

Roping-Describes an image distortion that gives solid straight lines a helical or twisted appearance. This problem is caused by poor convergence.

S

Scan-The process by which an image is developed. The electron beams excite the phosphor on the monitor screen dot by dot and line by line. The faster the scanning the more stable the image.

Shadow Mask-A mask formed behind the screen of a monitor. It consists of small holes that are used to filter and focus the light emitted from the electron gun.

Sharpness-Rather subjective and dependent on the eyes' interpretation of the image.

Slot Mask-Also called aperture grille. Serves the same function as the shadow mask except that the slot mask is made up of vertical wires stretched behind the screen. This mask technology enables more light to filter through the mask, therefore giving the screen a brighter image.

Stripe Pitch-The equivalent of dot pitch on Trinitron tubes; the distance between one stripe and the next one of the same color, expressed in millimeters.

SuperClear™-SuperClear offers up to 30% more brightness and contrast, due to the addition of micro filters, than conventional CRT's.

SVGA-An acronym for Super Video Graphics Array. A standard characterized by a resolution of 800 by 600.

Swim-An image should be rock-steady on the monitor screen. Swim, like similar characteristics jitter and drift, is a measure of how much an on-screen image wavers over a given time.

T

Triad-A triad contains three phosphor filled dots-one red, one green and one blue-arranged in a triangular fashion. Each of the three electron guns are dedicated to one of these colors (for example, the red gun excites only a triad's red phosphor dot). As the guns scan the screen, each active triad produces a single color, which depends on the combination of excited color dots and how active each dot is.

U

UVGA-Ultra Video Graphic Array. It refers to 1024 by 768 resolution.

V

Vertical Refresh Rate-See Refresh Rate.

Vertical Scanning-The movement the electron beam traces across vertical phosphor dots on the CRT.

VESA®-An acronym for Video Electronic Standards Association. The association that standardizes the graphics boards with both software and monitors. It set the standardized refresh rate of 72Hz for SVGA (800x600) and VGA (640x480).

VGA-A Video Graphic Array (VGA) monitor has a standardized resolution of 640x480.

Video Bandwidth-See Bandwidth.

VLf-An acronym for Very Low Frequency. Defines frequency range from 3,000 to 30,000 Hz. This type of radiation is emitted from the monitor's deflective yoke.

X

XGA-An Extended Graphics Array (XGA) monitor has a standardized resolution of 1024 by 768.

Index

Numerics

- 2201 PC-Bus Controller, 65
- 2201 Emulation Modes, 75
- 2201 PC-Bus Controller, 73
- 2210 Emulation Modes, 73
- 2210 Serial Controller, 64, 71
- 2210 Serial Controller and 3000U USB Controller, 36
- 3000U USB Controller, 73

A

- About AccuTouch Touchscreens, 5
- absolute coordinates, 7
- address, Base I/O Port, 15, 62
- adhesive tape, 30, 32
- agency approvals, 40
- analog to digital converter (ADC), 7
- anode button, 25, 27, 45
- anode lead, 25, 45
- ASCII terminal, 57
- averaging algorithm, 7

B

- Base I/O Port address, 15, 62, 63
- baud rate, 64
- bell, CRT, 25, 26, 28, 45
- bezel
 - distance from CRT, 32
- bezel and touchscreen clearance, 33
- binary data format, 58
- bonding touchscreen to CRT, 6
- breakout box, 60
- bulkhead connector, mounting, 38, 40, 42
- Bus Controller, 52, 62
- BUSSTAT program, 22, 62, 63

C

- Cable and Connector, 78
- cables
 - CRT, 26
 - problems, 52
 - routing, 44
 - troubleshooting, 63
- calibration, 8, 31, 53
- calibration flag, 59
- Care and Cleaning, 2
- CE approval, 9, 22, 35, 45
- chassis removal, 27
- clearance

- bezel and touchscreen, 32
- clearance, bezel and touchscreen, 26, 27
- Closed Circuit Resistance, 79
- code
 - machine-independent source, 18
- COMDUMP program, 22, 50, 51, 57
- communications parameters, serial controllers, 57
- component installation, 19
- Connecting the Power and Video, 10
- connection
 - chassis to ground, 42
- Constant touch data, 51, 57
- Contents, Touchmonitor with internal serial controller, 11
- Contents, touchmonitor with internal USB controller, 12
- Controller Configuration, 69
- controllers
 - Base I/O Port address, 15, 62
 - E261-280 emulation, 13
 - E271-140 emulation, 13, 73
 - E271-141 emulation, 15
 - E271-2201, 15
 - E271-2210, 11, 13
 - external serial, 10, 13
 - grounding, 37
 - installing in PC, 15
 - internal E271-2210, TouchMonitor with, 10, 11
 - internal serial, installation, 39
 - kits, 11
 - Mounting Kit, 36
 - PC-Bus, 10
 - PC-Bus Controller Kit (E271-2201), 15
 - RS-232, 10, 60
 - specifications, 37, 38, 65
 - Tabletop Serial Controller, 13
- coordinate
 - conversion, 7
 - normalization/scaling, 7
- coordinates
 - absolute, 7
 - Cartesian, 7
 - untranslated (raw), 7
 - X and Y, 7
- CSA Approval, 22, 35, 45

D

- DB9 and DB25 Connector Pin Positions, 67
- DB9 bulkhead connector, 38, 40, 42
- detaching back case, 24
- Diagnostic Codes, 66

- Diagnostic LED's, 64
- diagnostic procedures, 53, 55
- Dimensions, 78
- Disassembling the Display, 24
- Discharging the CRT, 25
- display
 - bezel, 29
 - power supply, 37
 - testing, 22
- Display Problems, 50
- distance from CRT, 32
- DOS
 - troubleshooting, 57
- Driver Software, 2, 8
- driver software
 - ELODEV, 57, 59
- DTE device, data connection, 60
- dummy touchscreen, 53, 55
- DuraTouch emulation, 75
- dust seal, 28, 31, 46

E

- E261-280 controller emulation, 13, 72
- E261-280 Controller Protocol, 58
- E271-140 controller emulation, 13, 72
- E271-140 Controller Protocol, 58
- E271-141 controller emulation, 15, 75
- E271-2201 controller, 15, 16
- E271-2201 PC-Bus Controller Kit, 15, 16
 - configuring, 15
 - installation, 15
- E271-2210 Controller Protocol, 58
- E271-2210 Tabletop Serial Controller Kit, 13
 - configuring, 13
 - installing, 13
- E274HL and E274A Enhanced Antiglare Products, 78, 79
- E274HL Products, 78
- E281A-4002 controller emulation, 72
- E281A-4002 Controller Protocol, 58
- electroluminescent (EL) displays, 47
- electronic-grade (non-corrosive) silicone adhesive, 45
- Elo Part Numbers, 81
- ELOCALIB, 51
- ELODEV driver, 50, 51, 55, 57, 59
- ELOGRAPH.CAL files, 51
- embedded systems driver, 8
- Emulation Modes, 58
- escutcheon, 39, 40, 43
- Expected Life Performance, 78
- External Controllers, 41
- eye protection, 20, 45

F

- failures, display, 49
- FCC Notice, vii
- Flat Panel Display Integration, 47
- flyback transformer, 25, 44

G

- General Information, 69
- Getting Started, 21
- Glossary, 85
- ground wire, 34
- grounding, 24, 25, 34, 60
 - controller, 37
 - touchscreen, 7, 37, 39, 42, 43

H

- handshaking lines, 60
- Hardware Troubleshooting, 51
- Haze, 79
- heat dissipation, 37
- heat sinks, 26

I

- installation
 - E271-2201 PC-Bus Controller Kit, 15
 - E271-2210 Tabletop Serial Controller Kit, 13
 - internal serial controller, 36, 37, 39
 - steps, 23
 - tools, 23
 - TouchMonitor with E271-2210 Internal Serial Controller, 11, 12
 - touchscreen, 29
- Installation, Touchmonitor with internal serial controller, 11
- Installation, touchmonitor with internal USB controller, 12
- Installing the 2210 Serial Controller, 37
- Installing the 3000U USB Controller, 39
- Installing the Touchscreen, 28
- IntelliTouch emulation, 73
- interference
 - fit, 32
- Internal Controllers, 36
- internal E271-2210, installation of TouchMonitor with, 11, 12
- internal serial controllers, 36
 - grounding, 37, 39
 - installing, 36, 37, 39
- Internal Touchscreen Controller Mounting Kit, 36
- Introducing Touchscreens, 1
- Introduction, 1, 5
- IRQ, 15, 59, 62, 74

J

- Jumper Settings, 70, 72
- Jumper Settings, E271-2201 PC-Bus controller, 74

K

- kits
 - Internal Touchscreen Controller Mounting, 37, 39
 - Touchscreen Installation, 36

L

- lead, anode, 25, 44, 45
- LED's, 64
- Light Transmission, 78
- Limited Warranty, v
- Linearity, 53
- liquid crystal displays (LCD's), 47

M

- materials for mounting touchscreen, 29
- Mechanical, 78
- mounting a touchscreen, 29
- mounting holes, 37

N

- neck, CRT, 24, 27, 45
- NEMA sealing, 46, 78
- No touch data, 52
- non-linearity, 53
- null modem, 60

O

- ohmmeter, checking cables with, 53
- Optical, 78
- optical bonding, 6
- oscillator/drive sections, 44

P

- P/N 454173-000 Cable, 63
- Part Numbers, Elo, 81
- PC-Bus Controller Kit (E271-2201), 15
- PC-Bus Controllers, 15
- PC-DOS, 10
- pinouts, 59, 61, 67
- plasma displays, 47
- plated-through mounting holes, 37
- Positional Accuracy, 78
- Power Supply, 44, 61
- problems
 - hardware, 52
 - power supply, 37

- serial controllers, 57, 59
- Protective Clothing, 20

R

- radius of curvature (ROC), 27, 30
- raw coordinates, 7, 57
- Reassembling the Display, 45
- Removing the Back Case, 24
- Removing the CRT, 27
- Removing the Electronics Chassis, 26
- Resolution, 78
- RGB video drive, 44
- Routing the Touchscreen Cables, 44
- RS-232 Connections, 8, 57, 59
- RS-232 DTE device, data connection, 60

S

- Safety Information, 20
- sealing, 28, 29
- Sealing the Monitor, 46
- Serial Controller, 52, 57
- serial controllers, 10
- settings, jumper, 72
- Shipping Damage, 2
- Software Troubleshooting, 50
- source code, machine-independent, 8, 18
- spacers, 29, 32
- spacing CRT from bezel, 29
- Spacing the CRT from the Bezel, 32
- Specifications, 77
- Standard and E274A Enhanced Antiglare Products, 78
- Standard Products, 79
- Surface Durability, 78

T

- Tabletop Serial Controller, 10, 13
- tape for mounting touchscreen, 28
- testing
 - components, 22
- The AccuTouch Controllers, 8
- The AccuTouch Touchscreen, 6
- The Troubleshooting Process, 49
- Touch Activation Force, 78
- TOUCHES program, 22, 59, 63
- TouchMonitor, 12
 - connections, 10
 - controllers, 10
 - installation, 11, 12, 13, 15, 16, 18
 - with internal E271-2210, installation, 11
- Touchmonitor
 - installation, 15
- Touchmonitor Benefits, 9

- Touchmonitor Configurations, 10
- Touchmonitor Connections, 10
- Touchmonitor Installation, 9
- Touchmonitor with Internal Serial Controller, 11
- Touchmonitor with internal USB controller, 12
- touchscreen, 7
 - aligning on CRT, 28, 29
 - CRT, attaching to, 29
 - dust seal, 28
 - grounding, 7, 37, 39, 42, 43
 - Installation Kit, 39, 40, 43
 - mounting, 29
 - transient protection, 37
 - voltage level, 7
- Touchscreen Application Tips, 16
- Touchscreen Cables, 63
- Touchscreen Diagnosis, 53
- Touchscreen Simulation, 55
- Transient Protection, 34
- transient protection, 34, 37, 38, 39, 42, 43, 45, 47, 52, 53
- Transient Protection Components, 64
- troubleshooting
 - hardware, 52, 57, 59, 65
 - serial controllers, 59
 - serial controllers running under DOS, 57, 59
- Troubleshooting Guide, 49

TÜV Rheinland Bauart Compliance, 80

U

- UL Notice, vii
- UNIX driver, 8
- Using the BUSSTAT Utility, 62
- Using the COMDUMP Utility, 57
- Using the TOUCHES Utility, 59

V

- Video Alignment Problems, 51
- video input cable, 44
- video mode, 51
- Visual Resolution, 79
- voltage, 6, 7
 - level, 7

W

- Where to Go from Here, 18, 47
- Work Area, 20

X

- X, Y, and Z coordinates, 7